

### Typical Applications

The HMC561LP3E are suitable for:

- Clock Generation Applications:  
SONET OC-192 & SDH STM-64
- Point-to-Point & VSAT Radios
- Test Instrumentation
- Military & Space

### Functional Diagram

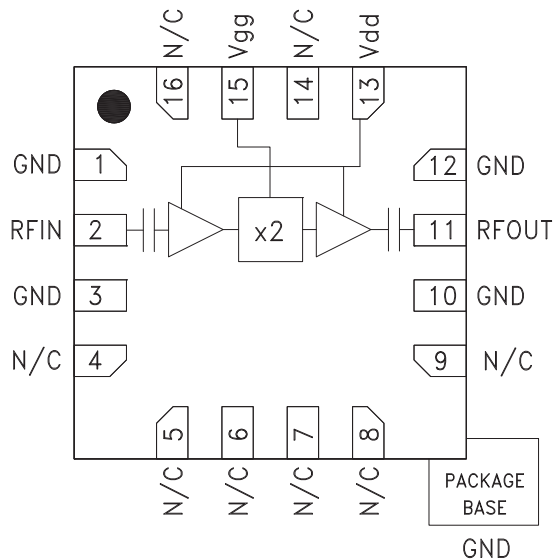

### Features

- High Output Power: +14 dBm
- Low Input Power Drive: 0 to +6 dBm
- Fo Isolation: 15 dBc @ Fout= 16 GHz
- 100 KHz SSB Phase Noise: -139 dBc/Hz
- RoHS Compliant 3x3 mm SMT Package

### General Description

The HMC561LP3(E) is a x2 active broadband frequency multiplier utilizing GaAs PHEMT technology in a leadless RoHS compliant SMT package. When driven by a +5 dBm signal, the multiplier provides +14 dBm typical output power from 8 to 21 GHz and the Fo and 3Fo isolations are 15 dBc at 16 GHz. The HMC561LP3(E) is ideal for use in LO multiplier chains for Pt to Pt & VSAT Radios yielding reduced parts count vs. traditional approaches. The low additive SSB Phase Noise of -139 dBc/Hz at 100 kHz offset helps maintain good system noise performance. The RoHS packaged HMC561LP3(E) eliminates the need for wire bonding, and allows the use of surface mount manufacturing techniques. For availability on Non-RoHS compliant HMC561LP3 product please contact Hittite Microwave sales directly.

### Electrical Specifications, $T_A = +25^\circ\text{C}$ , $V_{dd} = +5\text{V}$ , 5 dBm Drive Level

Parameter	Min.	Typ.	Max.	Units
Frequency Range, Input	4 - 10.5			GHz
Frequency Range, Output	8 - 21			GHz
Output Power	11	14		dBm
Fo Isolation (with respect to output level)		15		dBc
3Fo Isolation (with respect to output level)		15		dBc
4Fo Isolation (with respect to output level)		20		dBc
Input Return Loss		16		dB
Output Return Loss		8		dB
SSB Phase Noise (100 kHz Offset)		-139		dBc/Hz
Supply Current (I <sub>dd</sub> ) (V <sub>dd</sub> = 5V, V <sub>gg</sub> = -1.7V Typ.)		98		mA

\*Adjust V<sub>gg</sub> between -2.0 and -1.2V to achieve I<sub>dd</sub> = 98 mA



**Output Power vs. Temperature @ 5 dBm Drive Level**

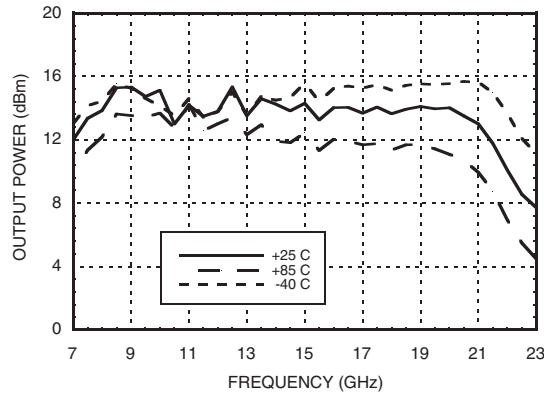

**Output Power vs. Drive Level**

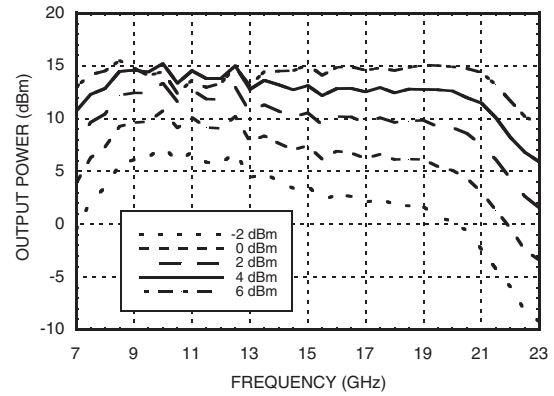

**Output Power vs. Supply Voltage @ 5 dBm Drive Level**

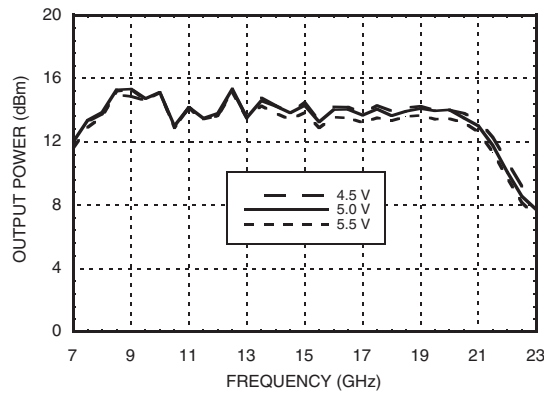

**Isolation @ 5 dBm Drive Level**

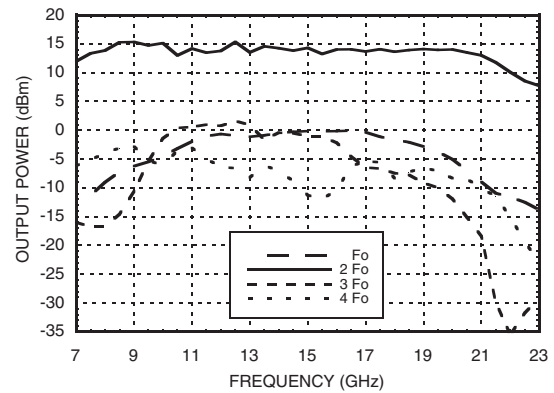

**Output Power vs. Input Power**

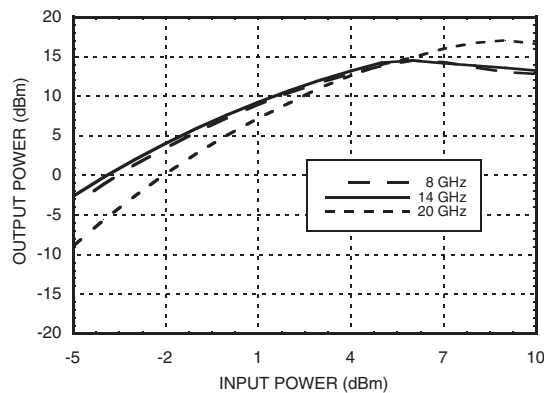

**SSB Phase Noise Performance, Fout= 16 GHz, Input Power = +3 dBm**

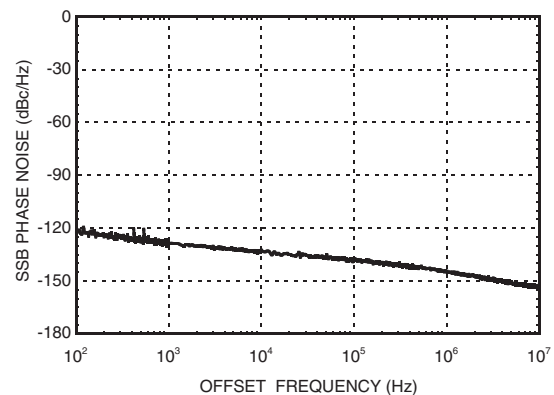



**Input Return Loss vs. Temperature**

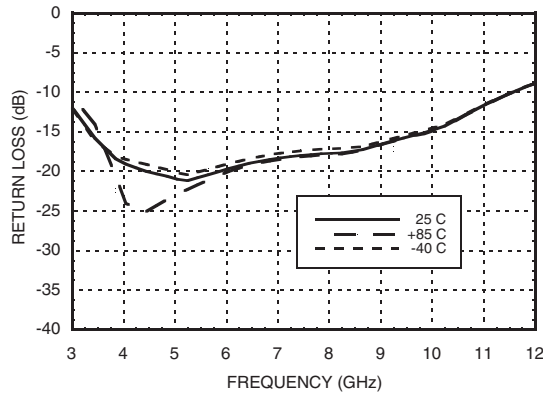

**Output Return Loss vs. Temperature**

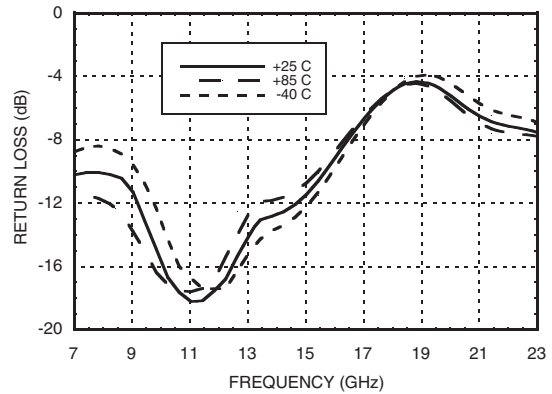

**Supply Current vs. Input Power**

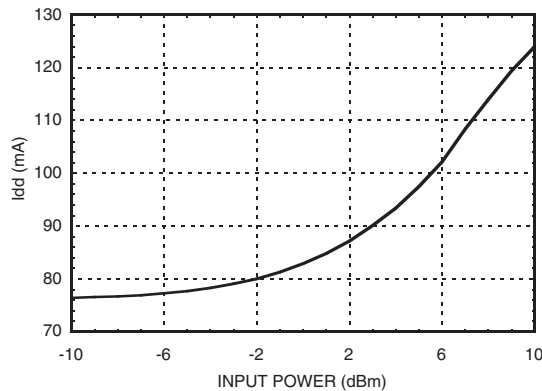

**Absolute Maximum Ratings**

RF Input (Vdd = +5V)	+10 dBm
Supply Voltage (Vdd)	+5.5 Vdc
Channel Temperature	150 °C
Continuous Pdiss (T= 85 °C) (derate 9.8 mW/°C above 85 °C)	635 mW
Thermal Resistance (channel to ground paddle)	102 °C/W
Storage Temperature	-65 to +150 °C
Operating Temperature	-40 to +85 °C

**Typical Supply Current vs. Vdd**

Vdd (Vdc)	Idd (mA)
4.5	97
5.0	98
5.5	99

Note:  
Multiplier will operate over full voltage range shown above.



**ELECTROSTATIC SENSITIVE DEVICE  
OBSERVE HANDLING PRECAUTIONS**

**Outline Drawing**

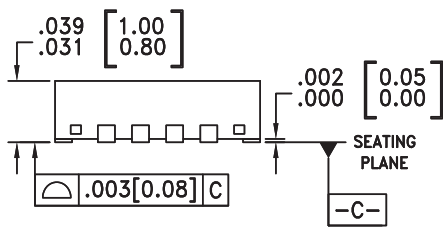
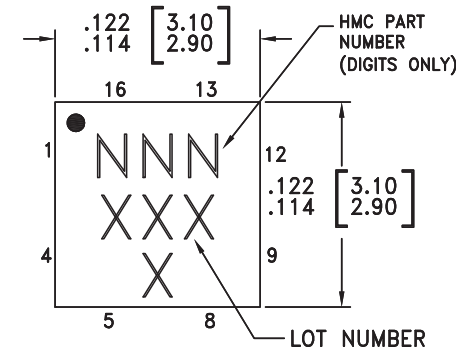

**BOTTOM VIEW**

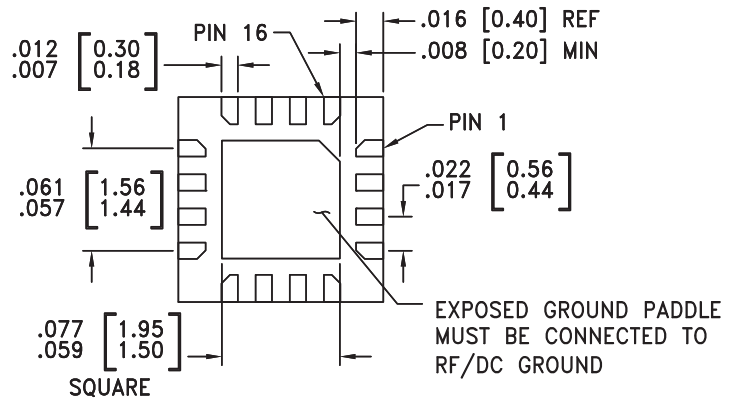

**NOTES:**

1. LEADFRAME MATERIAL: COPPER ALLOY
2. DIMENSIONS ARE IN INCHES [MILLIMETERS]
3. LEAD SPACING TOLERANCE IS NON-CUMULATIVE.
4. PAD BURR LENGTH SHALL BE 0.15mm MAXIMUM.  
PAD BURR HEIGHT SHALL BE 0.05mm MAXIMUM.
5. PACKAGE WARP SHALL NOT EXCEED 0.05mm.
6. ALL GROUND LEADS AND GROUND PADDLE MUST BE SOLDERED TO PCB RF GROUND.
7. REFER TO HITTITE APPLICATION NOTE FOR SUGGESTED LAND PATTERN.

**Package Information**

Part Number	Package Body Material	Lead Finish	MSL Rating	Package Marking <sup>[3]</sup>
HMC561LP3	Low Stress Injection Molded Plastic <sup>[4]</sup>	Sn/Pb Solder	MSL1 <sup>[1]</sup>	561 XXXX
HMC561LP3E	RoHS-compliant Low Stress Injection Molded Plastic	100% matte Sn	MSL1 <sup>[2]</sup>	561 XXXX

[1] Max peak reflow temperature of 235 °C

[2] Max peak reflow temperature of 260 °C



[3] 4-Digit lot number XXXX

[4] For availability on Non-RoHS HMC561LP3 products please contact Hittite Microwave sales directly.

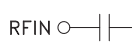
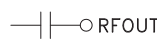
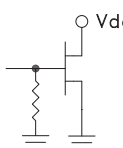

## SMT GaAs MMIC x2 ACTIVE FREQUENCY MULTIPLIER, 8 - 21 GHz OUTPUT

### Pin Description

Pin Number	Function	Description	Interface Schematic
1, 3, 10, 12	GND	Package bottom must also be connected to RF/DC ground.	
2	RFIN	Pin is AC coupled and matched to 50 Ohms.	
4 - 9, 14, 16	N/C	These pins are internally not connected; however, this product was specified with these pins connected to RF/DC ground.	
11	RFOUT	Pin is AC coupled and matched to 50 Ohms.	
13	Vdd	Supply voltage 5V ± 0.5V. External bypass capacitors of 100 pF, 1,000 pF and 2.2 μF are required.	
15	Vgg	Gate control for multiplier. Adjust to achieve I <sub>dd</sub> of 98 mA. Please follow "MMIC Amplifier Biasing Procedure" Application note.	

### Application Circuit

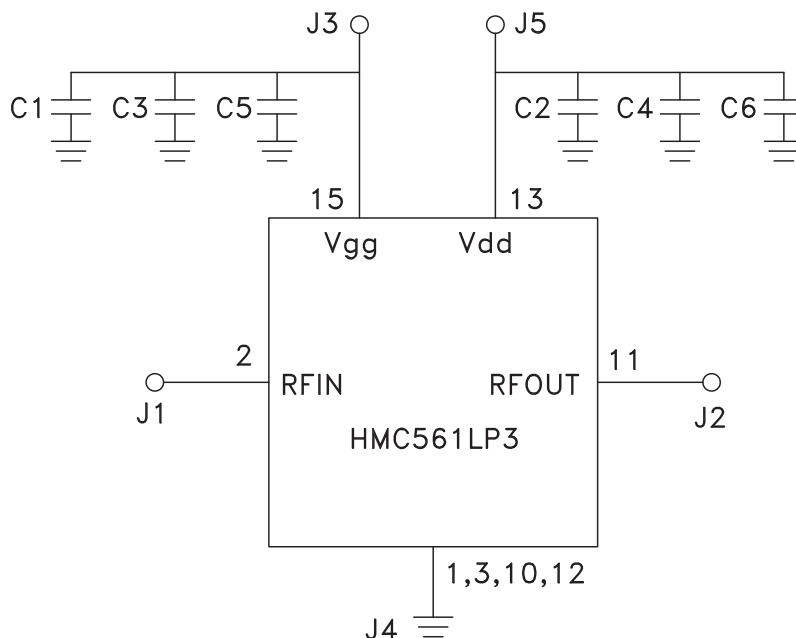

Component	Value
C1, C2	100 pF
C3, C4	1,000 pF
C5, C6	2.2 μF

### Evaluation PCB

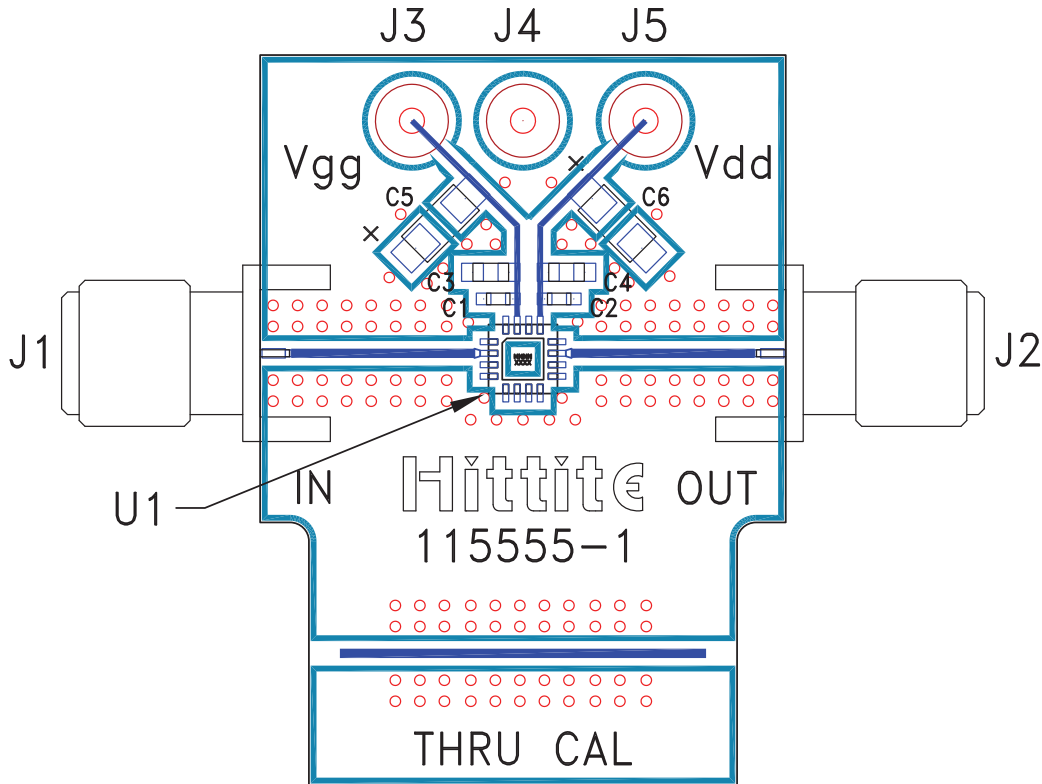

### List of Materials for Evaluation PCB 115556 [1]

Item	Description
J1, J2	PCB Mount SRI K Connector
J3 - J5	DC Pin
C1, C2	100 pF Capacitor, 0402 Pkg.
C3, C4	1,000 pF Capacitor, 0603 Pkg.
C5, C6	2.2 $\mu$ F Tantalum Capacitor
U1	HMC561LP3E x2 Active Multiplier
PCB [2]	115555 Eval Board

[1] Reference this number when ordering complete evaluation PCB

[2] Circuit Board Material: Rogers 4350

The circuit board used in the final application should be generated with proper RF circuit design techniques. Signal lines should have 50 ohm impedance while the package ground leads and exposed paddle should be connected directly to the ground plane similar to that shown. A sufficient number of via holes should be used to connect the top and bottom ground planes. The evaluation circuit board shown is available from Hittite upon request.