

Overview

The KEMET Organic Capacitor (KO-CAP) is a tantalum capacitor with a Ta anode and Ta₂O₅ dielectric. A conductive organic polymer replaces the traditionally used MnO₂ as the cathode plate of the capacitor. This results in very low ESR and improved capacitance retention at high frequency. Combining this advancement with the use of a multiple anode design delivers the lowest ESR values available in the industry. The KO-CAP may also be operated at steady state voltages at up to 90% of rated

voltage for part types with rated voltages of ≤ 10 volts and up to 80% of rated voltage for part types > 10 volts.

The T541 Series KO-CAP offers the same advantages as the T530 Series but is also designed for the Commercial Off-the-Shelf (COTS) requirements of defense and aerospace applications. This surface mount product offers a tin lead (SnPb) leadframe finish, surge current testing options and standard or low ESR levels.

Benefits

- ESR: 10 mΩ to 40 mΩ
- 125°C maximum operating temperature
- Polymer cathode technology
- High frequency capacitance retention
- Benign failure mode
- Capacitance: 22 μF to 1,500 μF
- 100% accelerated steady state aging
- Surge current testing options
- Utilizes multiple tantalum anode technology
- Volumetric efficiency
- Use at up to 90% of rated voltage (10% derating) for part types ≤ 10 V
- Use at up to 80% of rated voltage (20% derating) for part types > 10 V
- Very low ESR
- EIA standard case sizes



Environmental Compliance

RoHS Compliant (6/6) according to Directive 2002/95/EC when ordered with 100% Sn solder.



RoHS Compliant

SPICE

For a detailed analysis of specific part numbers, please visit www.kemet.com for a free download of KEMET's SPICE software. The KEMET SPICE program is freeware intended to aid design engineers in analyzing the performance of these capacitors over frequency, temperature, ripple, and DC bias conditions.

Ordering Information

T	541	D	157	M	10	A	H	65	10
Capacitor Class	Series	Case Size	Capacitance Code (pF)	Capacitance Tolerance	Voltage	Failure Rate/Design	Lead Material	Surge Option	ESR
T = Tantalum	541 = Polymer COTS Multiple Anode	D = 7343-31 X = 7343-43 Y = 7343-40	First two digits represent significant figures. Third digit specifies number of zeros.	M = $\pm 20\%$	2R5 = 2.5 V 003 = 3 V 004 = 4 V 006 = 6.3 V 010 = 10 V 016 = 16 V 020 = 20 V 025 = 25 V 035 = 35 V 050 = 50 V	A = N/A	H = Standard Solder Coated (SnPb 5% Pb minimum)	65 = No Surge 66 = 10 cycles @ 25°C 67 = 10 cycles -55°C and 85°C	10 = ESR-Standard 20 = ESR-Low 30 = ESR-Ultra Low

Applications

Typical applications include decoupling and filtering in defense and aerospace applications that require low ESR or a benign failure mode.

Performance Characteristics

Item	Performance Characteristics
Operating Temperature	-55°C to 125°C *
Rated Capacitance Range	22 – 1,500 μF @ 120 Hz/25°C
Capacitance Tolerance	M Tolerance (20%)
Rated Voltage Range	2.5 – 50 V
DF (120 Hz)	8%
ESR (100 kHz)	Refer to Part Number Electrical Specification Table
Leakage Current	$\leq 0.1\text{C V}$ (μA) at rated voltage after 5 minutes

* KEMET's Polymer COTS (T540/T541 Series) capacitors are rated for operation between -55°C and +125°C. Parametric electrical performance remains within stated specification limits after 1,000 hours of continuous operation and/or storage at +125°C. Long-term duty cycles or storage at or above +125°C may result in an increase in ESR performance outside of the stated specification limits.

Qualification

Test	Condition	Characteristics				
Endurance	105°C @ rated voltage, 2,000 hours 125°C @ 2/3 rated voltage, 2,000 hours	Δ C/C	Within -20%/+10% of initial value			
		DF	≤ initial limit			
		DCL	1.25 x initial limit @ 125°C			
		ESR	2 x IL @ 105°C, 5 x IL @ 125°C			
Storage Life	125°C @ 0 volts, 2,000 hours	Δ C/C	Within -20%/+10% of initial value			
		DF	Within initial limits			
		DCL	Within 2.0 x initial limit			
		ESR	Within 5.0 x initial limit			
Humidity	60°C, 90% RH, 500 hours, rated voltage 60°C, 90% RH, 500 hours, no load	Δ C/C	Within -5%/+35% of initial value			
		DF	≤ initial limit			
		DCL	Within 3.0 x initial limit			
Temperature Stability	Extreme temperature exposure at a succession of continuous steps at +25°C, -55°C, +25°C, +85°C, +125°C, +25°C		+25°C	-55°C	+85°C	+125°C
		Δ C/C	IL*	±20%	±20%	±30%
		DF	IL	IL	1.2 x IL	1.5 x IL
Surge Voltage	105°C, 1.32 x rated voltage, 33 Ω resistance, 1,000 cycles	Δ C/C	Within -20%/+10% of initial value			
		DF	Within initial limits			
		DCL	Within initial limits			
Mechanical Shock/Vibration	MIL-STD-202, Method 213, Condition I, 100 G peak MIL-STD-202, Method 204, Condition D, 10 Hz to 2,000 Hz, 20 G peak	Δ C/C	Within ±10% of initial value			
		DF	Within initial limits			
		DCL	Within initial limits			
Additional Qualification Tests per MIL-PRF-55365/8	Please contact KEMET for more information.					

*IL = Initial limit

Certification

MIL-PRF-55365/8

Electrical Characteristics

ESR vs. Frequency

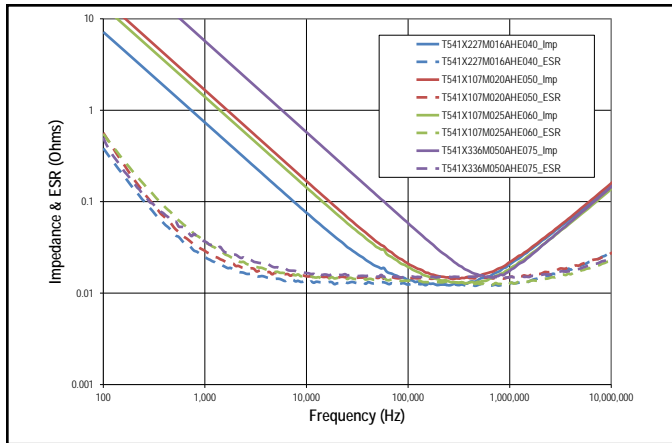

Capacitance vs. Frequency

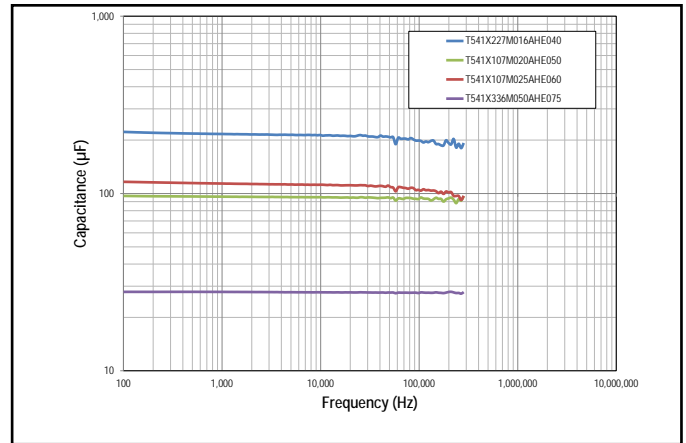

Dimensions – Millimeters (Inches)

Metric will govern

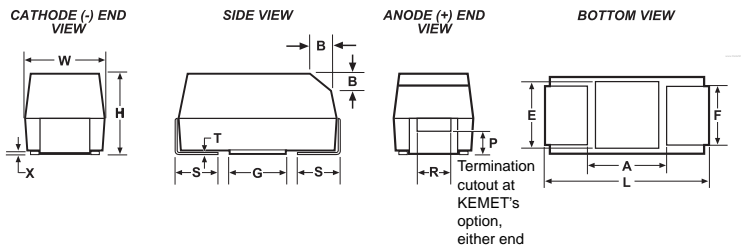

Case Size		Component												
KEMET	EIA	L*	W*	H*	F* ±0.1 ±(0.004)	S* ±0.3 ±(0.012)	B* ±0.15 (Ref) ±0.006	X (Ref)	P (Ref)	R (Ref)	T (Ref)	A (Min)	G (Ref)	E (Ref)
D	7343-31	7.3 ±0.3 (.287 ±0.012)	4.3 ±0.3 (.169 ±0.012)	2.8 ±0.3 (.110 ±0.012)	2.4 (.094)	1.3 (.051)	0.5 (.020)	0.10 ±0.10 (.004 ±0.004)	0.9 (.035)	1.0 (.039)	0.13 (.005)	3.8 (.150)	3.5 (.138)	3.5 (.138)
X	7343-43	7.3 ±0.3 (.287 ±0.012)	4.3 ±0.3 (.169 ±0.012)	4.0 ±0.3 (.157 ±0.012)	2.4 (.094)	1.3 (.051)	0.5 (.020)	0.10 ±0.10 (.004 ±0.004)	1.7 (.067)	1.0 (.039)	0.13 (.005)	3.8 (.150)	3.5 (.138)	3.5 (.138)
Y	7343-40	7.3 ±0.3 (.287 ±0.012)	4.3 ±0.3 (.169 ±0.012)	4.0 (0.157)	2.4 (.094)	1.3 (.051)	0.5 (.020)	0.10 ±0.10 (.004 ±0.004)	1.7 (.067)	1.0 (.039)	0.13 (.005)	3.8 (.150)	3.5 (.138)	3.5 (.138)

Notes: (Ref) – Dimensions provided for reference only. No dimensions are provided for B, P or R because low profile cases do not have a bevel or a notch.

* MIL-C-55365/8 specified dimensions

Table 1 – Ratings & Part Number Reference

Capacitance μF	Case Size	KEMET Part Number	DC Leakage	DF	ESR	Ripple Current (Arms) 100 kHz Maximum	
			μA @ 25°C Maximum	% @ 25°C 120 Hz Maximum	mΩ @ 25°C 100 kHz Maximum	w/ΔT= 20°C @ -55°C to 105°C	w/ΔT= 2°C @ 125°C
2.5 Volt Rating at 105°C (1.7 Volt Rating at 125°C)							
470	D	T541D477M2R5AH(1)20	118	10	6	6.5	2.1
470	D	T541D477M2R5AH(1)10	118	10	10	5.0	1.6
680	Y	T541Y687M2R5AH(1)30	170	10	5	7.3	2.3
680	Y	T541Y687M2R5AH(1)20	170	10	6	6.6	2.1
680	Y	T541Y687M2R5AH(1)10	170	10	10	5.1	1.6
680	D	T541D687M2R5AH(1)20	170	10	6	6.5	2.1
680	D	T541D687M2R5AH(1)10	170	10	10	5.0	1.6
1000	X	T541X108M2R5AH(1)30	250	10	5	7.3	2.4
1000	X	T541X108M2R5AH(1)20	250	10	6	6.7	2.1
1000	X	T541X108M2R5AH(1)10	250	10	10	5.2	1.7
1500	X	T541X158M2R5AH(1)30	375	10	5	7.3	2.4
1500	X	T541X158M2R5AH(1)20	375	10	6	6.7	2.1
1500	X	T541X158M2R5AH(1)10	375	10	10	5.2	1.7
3 Volt Rating at 105°C (2 Volt Rating at 125°C)							
470	D	T541D477M003AH(1)10	141	10	10	5.0	1.6
680	D	T541D687M003AH(1)10	204	10	10	5.0	1.6
1000	X	T541X108M003AH(1)10	300	10	10	5.2	1.7
1500	X	T541X158M003AH(1)10	450	10	8	5.8	1.9
4 Volt Rating at 105°C (2.7 Volt Rating at 125°C)							
330	D	T541D337M004AH(1)20	132	10	6	6.5	2.1
330	D	T541D337M004AH(1)10	132	10	10	5.0	1.6
470	D	T541D477M004AH(1)10	188	10	10	5.0	1.6
470	Y	T541Y477M004AH(1)30	188	10	5	7.3	2.3
470	Y	T541Y477M004AH(1)20	188	10	6	6.6	2.1
470	Y	T541Y477M004AH(1)10	188	10	10	5.1	1.6
680	X	T541X687M004AH(1)30	272	10	5	7.3	2.4
680	X	T541X687M004AH(1)20	272	10	6	6.7	2.1
680	X	T541X687M004AH(1)10	272	10	10	5.2	1.7
1000	X	T541X108M004AH(1)20	400	10	6	6.7	2.1
1000	X	T541X108M004AH(1)10	400	10	10	5.2	1.7
6.3 Volt Rating at 105°C (4.2 Volt Rating at 125°C)							
220	D	T541D227M006AH(1)20	139	10	6	6.5	2.1
220	D	T541D227M006AH(1)10	139	10	10	5.0	1.6
330	D	T541D337M006AH(1)10	208	10	10	5.0	1.6
330	Y	T541Y337M006AH(1)30	208	10	5	7.3	2.3
330	Y	T541Y337M006AH(1)20	208	10	6	6.6	2.1
330	Y	T541Y337M006AH(1)10	208	10	10	5.1	1.6
470	X	T541X477M006AH(1)30	296	10	5	7.3	2.4
470	X	T541X477M006AH(1)20	296	10	6	6.7	2.1
470	X	T541X477M006AH(1)10	296	10	10	5.2	1.7
10 Volt Rating at 105°C (6.6 Volt Rating at 125°C)							
150	D	T541D157M010AH(1)20	150	10	6	6.5	2.1
150	D	T541D157M010AH(1)10	150	10	10	5.0	1.6
220	D	T541D227M010AH(1)20	220	10	6	6.5	2.1
220	D	T541D227M010AH(1)10	220	10	10	5.0	1.6
220	Y	T541Y227M010AH(1)20	220	10	6	6.6	2.1
220	Y	T541Y227M010AH(1)10	220	10	10	5.1	1.6
330	X	T541X337M010AH(1)30	330	10	5	7.3	2.4
330	X	T541X337M010AH(1)20	330	10	6	6.7	2.1
330	X	T541X337M010AH(1)10	330	10	10	5.2	1.7
Capacitance μF	Case Size	KEMET Part Number	DC Leakage	DF	ESR	Ripple Current (Arms) 100 kHz Maximum	

(1) To complete KEMET part number, insert 65 = None, 66 = 10 cycles +25°C, 67 = 10 cycles -55°C and +85°C. Designates surge current option. Please refer to Ordering Information for additional details.

Table 1 – Ratings & Part Number Reference

Capacitance μF	Case Size	KEMET Part Number	DC Leakage	DF	ESR	Ripple Current (Arms) 100 kHz Maximum	
			μA @ 25°C Maximum	% @ 25°C 120 Hz Maximum	m Ω @ 25°C 100 kHz Maximum	w/ ΔT = 20°C @ -55°C to 105°C	w/ ΔT = 2°C @ 125°C
16 Volt Rating at 105°C (10.7 Volt Rating at 125°C)							
150	X	T541X157M016AH(1)20	240	10	25	3.3	1.1
150	X	T541X157M016AH(1)10	240	10	40	2.6	0.8
220	X	T541X227M016AH(1)20	352	10	25	3.3	1.1
220	X	T541X227M016AH(1)10	352	10	40	2.6	0.8
330	X	T541X337M016AH(1)20	528	10	25	3.3	1.1
330	X	T541X337M016AH(1)10	528	10	50	2.3	0.7
20 Volt Rating at 105°C (13.4 Volt Rating at 125°C)							
100	X	T541X107M020AH(1)10	200	10	50	2.3	0.7
25 Volt Rating at 105°C (16.7 Volt Rating at 125°C)							
68	X	T541X686M025AH(1)10	170	10	50	2.3	0.7
100	X	T541X107M025AH(1)10	250	10	60	2.1	0.7
35 Volt Rating at 105°C (23.4 Volt Rating at 125°C)							
33	X	T541X336M035AH(1)10	116	10	60	2.1	0.7
47	X	T541X476M035AH(1)10	165	10	60	2.1	0.7
50 Volt Rating at 105°C (33.5 Volt Rating at 125°C)							
22	X	T541X226M050AH(1)10	110	10	75	1.9	0.6
33	X	T541X336M050AH(1)10	165	10	75	1.9	0.6
Capacitance μF	Case Size	KEMET Part Number	DC Leakage	DF	ESR	Ripple Current (Arms) 100 kHz Maximum	

(1) To complete KEMET part number, insert 65 = None, 66 = 10 cycles +25°C, 67 = 10 cycles -55°C and +85°C. Designates surge current option. Please refer to Ordering Information for additional details.

Derating Guidelines

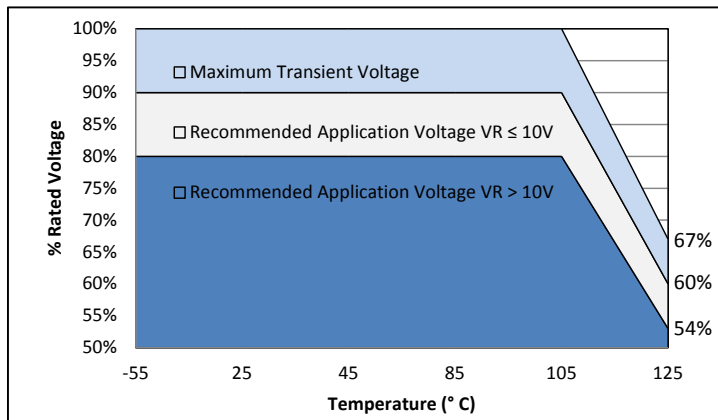

Voltage Rating	Maximum Recommended Steady State Voltage	Maximum Recommended Transient Voltage (1 ms – 1 μs)	Maximum Recommended Steady State Voltage	Maximum Recommended Transient Voltage (1 ms – 1 μs)
	-55°C to 105°C		105°C to 125°C	
$2.5 \text{ V} \leq V_R \leq 10 \text{ V}$	90% of V_R	V_R	60% of V_R	67% of V_R
$10 \text{ V} < V_R \leq 50 \text{ V}$	80% of V_R	V_R	54% of V_R	67% of V_R

V_R = Rated Voltage

Ripple Current/Ripple Voltage

Permissible AC ripple voltage and current are related to equivalent series resistance (ESR) and the power dissipation capabilities of the device. Permissible AC ripple voltage which may be applied is limited by two criteria:

a. The positive peak AC voltage plus the DC bias voltage, if any, must not exceed the DC voltage rating of the capacitor.

b. The negative peak AC voltage in combination with bias voltage, if any, must not exceed the allowable limits specified for reverse voltage. See the Reverse Voltage section for allowable limits.

The maximum power dissipation by case size can be determined using the below table. The maximum power dissipation rating stated in the table must be reduced with increasing environmental operating temperatures. Refer to the below table for temperature compensation requirements.

Case Code		Maximum Power Dissipation (P max) mWatts @ 45°C with +30°C Rise	Temperature Compensation Multipliers for Maximum Power Dissipation		
KEMET	EIA		≤ 45°C	45° C < T ≤ 85°C	85°C < T ≤ 125°C
T520T/T525T/T540T/ T543T	3528-12	105	1.00	0.70	0.25
T520M/T543M	3528-15	120			
T520A/T543A	3216-18	112			
T520B/T525B/T540B/ T543B	3538-21	127			
T520U/T543U	6032-15	135			
T520L/T543L	3528-19	150			
T520C/T543C	6032-28	165			
T520W/T545W/T543W	7343-15	180			
T520V/T521V/T522V/ T545V/T543V	7343-20	187			
T520D/T521D/T525D/ T540D/T545D/T543D	7343-31	225			
T520Y/T522Y/T525Y/ T543Y	7343-40	241			
T520X/T521X/T545X/ T543X	7343-43	247			
T545E	7260-38	345			
T520H/T545H/T543H	7260-20	187			
T528I	3216-10	95			
T528K	3528-10	150			
T528W	7343-15	325			
T528Z	7343-17	325			
T530/T541D	7343-31	255			
T530/T541Y	7343-40	263			
T530/T541X	7443-43	270			

T = Environmental Temperature

Using the P max of the device, the maximum allowable rms ripple current or voltage may be determined.

$$I(max) = \sqrt{P_{max}/R}$$

$$E(max) = \sqrt{P_{max} \cdot R}$$

I = rms ripple current (amperes)

E = rms ripple voltage (volts)

P max = maximum power dissipation (watts)

R = ESR at specified frequency (ohms)

The maximum power dissipation rating must be reduced with increasing environmental operating temperatures. Refer to the Temperature Compensation Multiplier table for details.

Reverse Voltage

Polymer tantalum capacitors are polar devices and may be permanently damaged or destroyed if connected in the wrong polarity. These devices will withstand a small degree of transient voltage reversal for short periods as shown in the below table.

Temperature	Permissible Transient Reverse Voltage
25°C	15% of Rated Voltage
55°C	10% of Rated Voltage
85°C	5% of Rated Voltage
105°C	3% of Rated Voltage
125°C*	1% of Rated Voltage

*For series rated to 125°C

Table 2 – Land Dimensions/Courtyard

KEMET	Metric Size Code	Density Level A: Maximum (Most) Land Protrusion (mm)					Density Level B: Median (Nominal) Land Protrusion (mm)					Density Level C: Minimum (Least) Land Protrusion (mm)				
		X	Y	C	V1	V2	X	Y	C	V1	V2	X	Y	C	V1	V2
D	7343-31	2.55	3.75	2.70	10.20	5.50	2.45	3.35	2.60	9.10	5.00	2.35	2.95	2.50	8.20	4.70
X ¹	7343-43	2.55	3.75	2.70	10.20	5.50	2.45	3.35	2.60	9.10	5.00	2.35	2.95	2.50	8.20	4.70
Y ¹	7343-35	2.55	3.75	2.70	10.20	5.50	2.45	3.35	2.60	9.10	5.00	2.35	2.95	2.50	8.20	4.70

Density Level A: For low-density product applications. Recommended for wave solder applications and provides a wider process window for reflow solder processes.

Density Level B: For products with a moderate level of component density. Provides a robust solder attachment condition for reflow solder processes.

Density Level C: For high component density product applications. Before adapting the minimum land pattern variations the user should perform qualification testing based on the conditions outlined in IPC Standard 7351 (IPC-7351).

¹ Height of these chips may create problems in wave soldering.

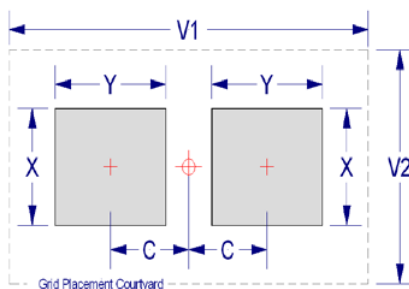

Soldering Process

KEMET’s families of surface mount capacitors are compatible with wave (single or dual), convection, IR, or vapor phase reflow techniques. Preheating of these components is recommended to avoid extreme thermal stress. KEMET’s recommended profile conditions for convection and IR reflow reflect the profile conditions of the IPC/J–STD–020D standard for moisture sensitivity testing. The devices can safely withstand a maximum of three reflow passes at these conditions.

Please note that although the X/7343–43 case size can withstand wave soldering, the tall profile (4.3 mm maximum) dictates care in wave process development.

Hand soldering should be performed with care due to the difficulty in process control. If performed, care should be taken to avoid contact of the soldering iron to the molded case. The iron should be used to heat the solder pad, applying solder between the pad and the termination, until reflow occurs. Once reflow occurs, the iron should be removed immediately. “Wiping” the edges of a chip and heating the top surface is not recommended.

During typical reflow operations, a slight darkening of the gold-colored epoxy may be observed. This slight darkening is normal and not harmful to the product. Marking permanency is not affected by this change.

Profile Feature	SnPb Assembly	Pb-Free Assembly
Preheat/Soak		
Temperature Minimum (T_{smin})	100°C	150°C
Temperature Maximum (T_{smax})	150°C	200°C
Time (t_s) from T_{smin} to T_{smax}	60 – 120 seconds	60 – 120 seconds
Ramp-up Rate (T_L to T_p)	3°C/seconds maximum	3°C/seconds maximum
Liquidous Temperature (T_L)	183°C	217°C
Time Above Liquidous (t_L)	60 – 150 seconds	60 – 150 seconds
Peak Temperature (T_p)	220°C* 235°C**	250°C* 260°C**
Time within 5°C of Maximum Peak Temperature (t_p)	20 seconds maximum	30 seconds maximum
Ramp-down Rate (T_p to T_L)	6°C/seconds maximum	6°C/seconds maximum
Time 25°C to Peak Temperature	6 minutes maximum	8 minutes maximum

Note: All temperatures refer to the center of the package, measured on the package body surface that is facing up during assembly reflow.

*Case Size D, E, P, Y, and X

**Case Size A, B, C, H, I, K, M, R, S, T, U, V, W, and Z

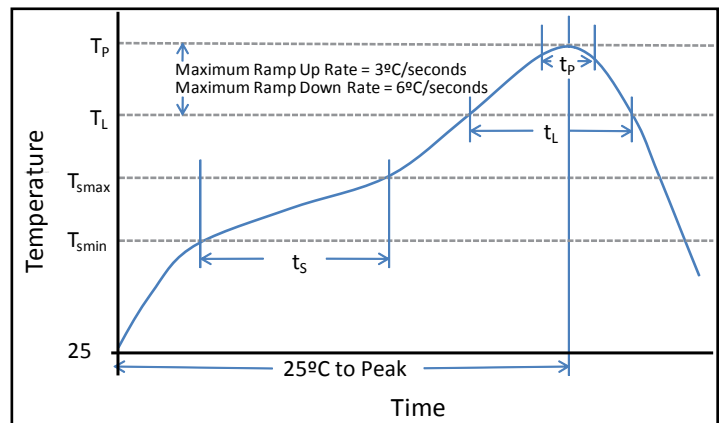

Construction

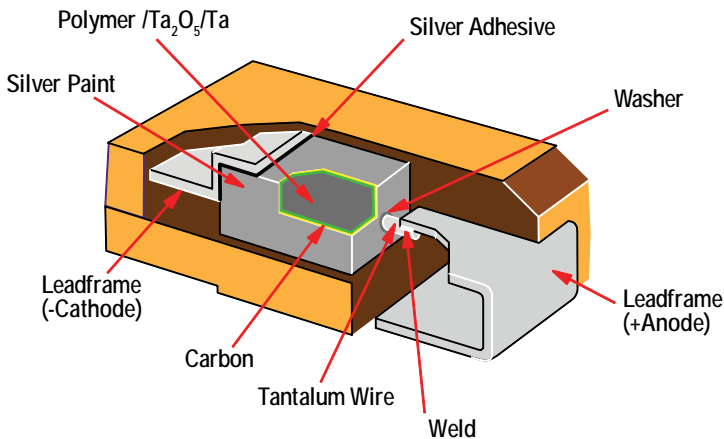

Capacitor Marking

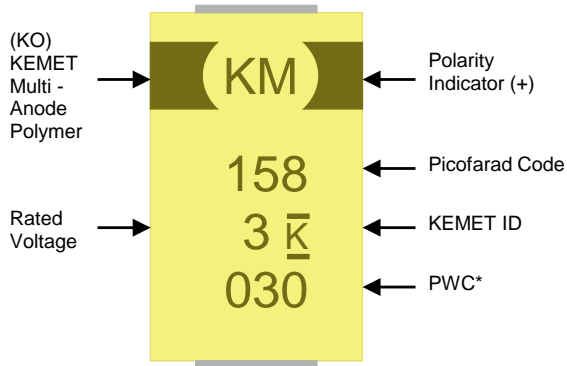

* 030 = 30th week of 2010

Storage

All KO-Cap series are shipped in moisture barrier bags with a desiccant and moisture indicator card. These series are classified as MSL3 (Moisture Sensitivity Level 3). Product contained within the moisture barrier bags should be stored in normal working environments with temperatures not to exceed 40°C and humidity not in excess of 60% RH.

Tape & Reel Packaging Information

KEMET's molded tantalum and aluminum chip capacitor families are packaged in 8 and 12 mm plastic tape on 7" and 13" reels in accordance with *EIA Standard 481-1: Embossed Carrier Taping of Surface Mount Components for Automatic Handling*. This packaging system is compatible with all tape-fed automatic pick-and-place systems.

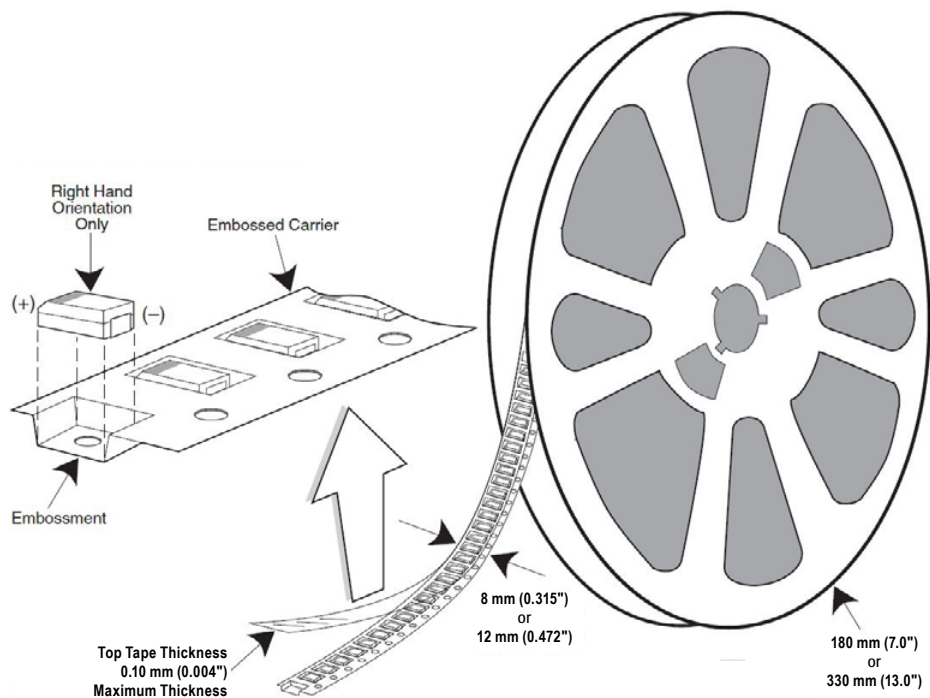

Table 3 – Packaging Quantity

Case Code		Tape Width (mm)	7" Reel*	13" Reel*
KEMET	EIA			
R	2012-12	8	2,500	10,000
I	3216-10	8	3,000	12,000
S	3216-12	8	2,500	10,000
T	3528-12	8	2,500	10,000
M	3528-15	8	2,000	8,000
U	6032-15	12	1,000	5,000
L	6032-19	12	1,000	5,000
W	7343-15	12	1,000	3,000
Z	7343-17	12	1,000	3,000
V	7343-20	12	1,000	3,000
A	3216-18	8	2,000	9,000
B	3528-21	8	2,000	8,000
C	6032-28	12	500	3,000
D	7343-31	12	500	2,500
Y	7343-40	12	500	2,000
X	7343-43	12	500	2,000
E/T428P	7260-38	12	500	2,000

* No C-Spec required for 7" reel packaging. C-7280 required for 13" reel packaging.

Figure 1 – Embossed (Plastic) Carrier Tape Dimensions

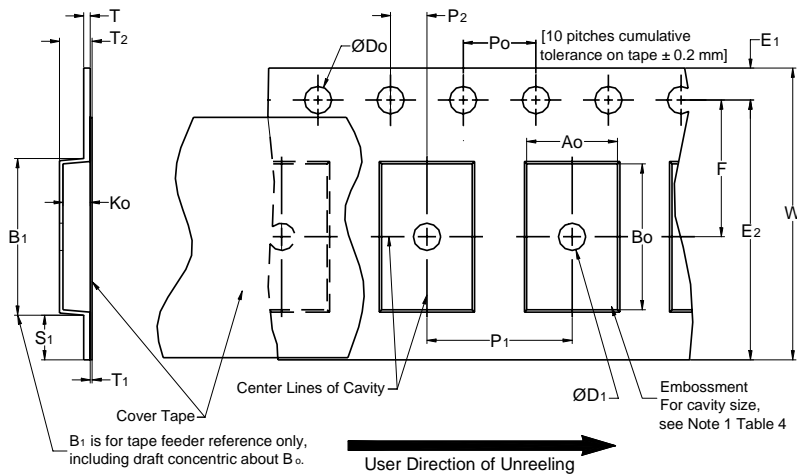

Table 4 – Embossed (Plastic) Carrier Tape Dimensions

Metric will govern

Constant Dimensions — Millimeters (Inches)									
Tape Size	D ₀	D ₁ Minimum Note 1	E ₁	P ₀	P ₂	R Reference Note 2	S ₁ Minimum Note 3	T Maximum	T ₁ Maximum
8 mm	1.5 +0.10/-0.0 (0.059 +0.004/-0.0)	1.0 (0.039)	1.75 ±0.10 (0.069 ±0.004)	4.0 ±0.10 (0.157 ±0.004)	2.0 ±0.05 (0.079 ±0.002)	25.0 (0.984)	0.600 (0.024)	0.600 (0.024)	0.100 (0.004)
12 mm		1.5 (0.059)				30 (1.181)			
16 mm									
Variable Dimensions — Millimeters (Inches)									
Tape Size	Pitch	B ₁ Maximum Note 4	E ₂ Minimum	F	P ₁	T ₂ Maximum	W Maximum	A ₀ , B ₀ & K ₀	
8 mm	Single (4 mm)	4.35 (0.171)	6.25 (0.246)	3.5 ±0.05 (0.138 ±0.002)	4.0 ±0.10 (0.157 ±0.004)	2.5 (0.098)	8.3 (0.327)	Note 5	
12 mm	Single (4 mm) & Double (8 mm)	8.2 (0.323)	10.25 (0.404)	5.5 ±0.05 (0.217 ±0.002)	8.0 ±0.10 (0.315 ±0.004)	4.6 (0.181)	12.3 (0.484)		
16 mm	Triple (12 mm)	12.1 (0.476)	14.25 (0.561)	5.5 ±0.05 (0.217 ±0.002)	8.0 ±0.10 (0.315 ±0.004)	4.6 (0.181)	16.3 (0.642)		

- The embossment hole location shall be measured from the sprocket hole controlling the location of the embossment. Dimensions of embossment location and hole location shall be applied independent of each other.
- The tape, with or without components, shall pass around R without damage (see Figure 5).
- If S₁ < 1.0 mm, there may not be enough area for cover tape to be properly applied (see EIA Standard 481–D, paragraph 4.3, section b).
- B₁ dimension is a reference dimension for tape feeder clearance only.
- The cavity defined by A₀, B₀ and K₀ shall surround the component with sufficient clearance that:
 - the component does not protrude above the top surface of the carrier tape.
 - the component can be removed from the cavity in a vertical direction without mechanical restriction, after the top cover tape has been removed.
 - rotation of the component is limited to 20° maximum for 8 and 12 mm tapes and 10° maximum for 16 mm tapes (see Figure 3).
 - lateral movement of the component is restricted to 0.5 mm maximum for 8 mm and 12 mm wide tape and to 1.0 mm maximum for 16 mm tape (see Figure 4).
 - see Addendum in EIA Standard 481–D for standards relating to more precise taping requirements.

Packaging Information Performance Notes

- 1. Cover Tape Break Force:** 1.0 Kg minimum.
- 2. Cover Tape Peel Strength:** The total peel strength of the cover tape from the carrier tape shall be:

Tape Width	Peel Strength
8 mm	0.1 to 1.0 Newton (10 to 100 gf)
12 and 16 mm	0.1 to 1.3 Newton (10 to 130 gf)

The direction of the pull shall be opposite the direction of the carrier tape travel. The pull angle of the carrier tape shall be 165° to 180° from the plane of the carrier tape. During peeling, the carrier and/or cover tape shall be pulled at a velocity of 300 ±10 mm/minute.

- 3. Labeling:** Bar code labeling (standard or custom) shall be on the side of the reel opposite the sprocket holes. Refer to EIA Standards 556 and 624.

Figure 2 – Maximum Component Rotation

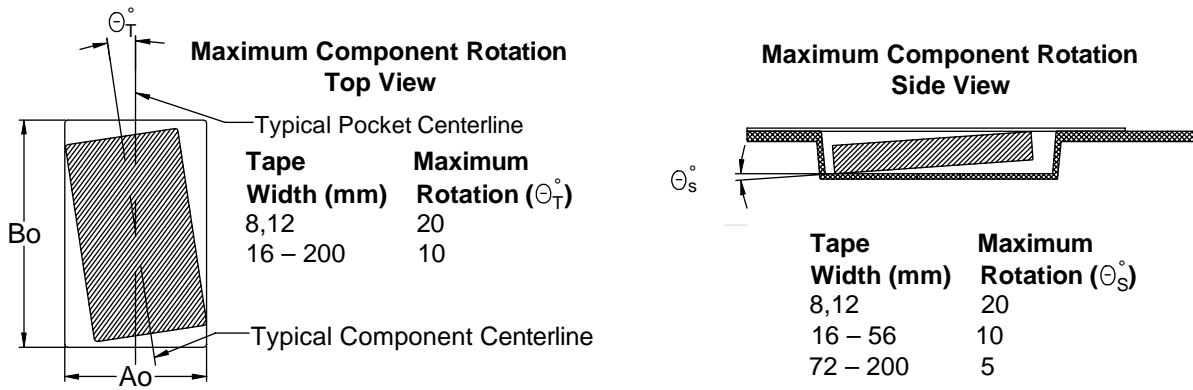

Figure 3 – Maximum Lateral Movement

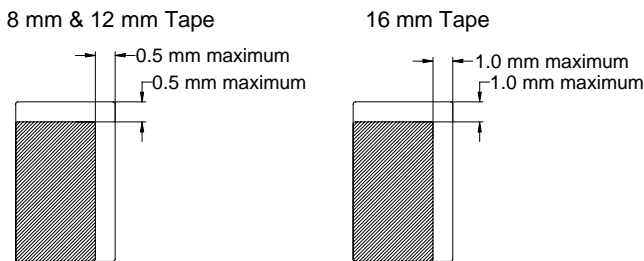

Figure 4 – Bending Radius

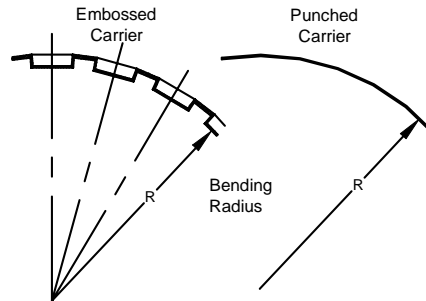
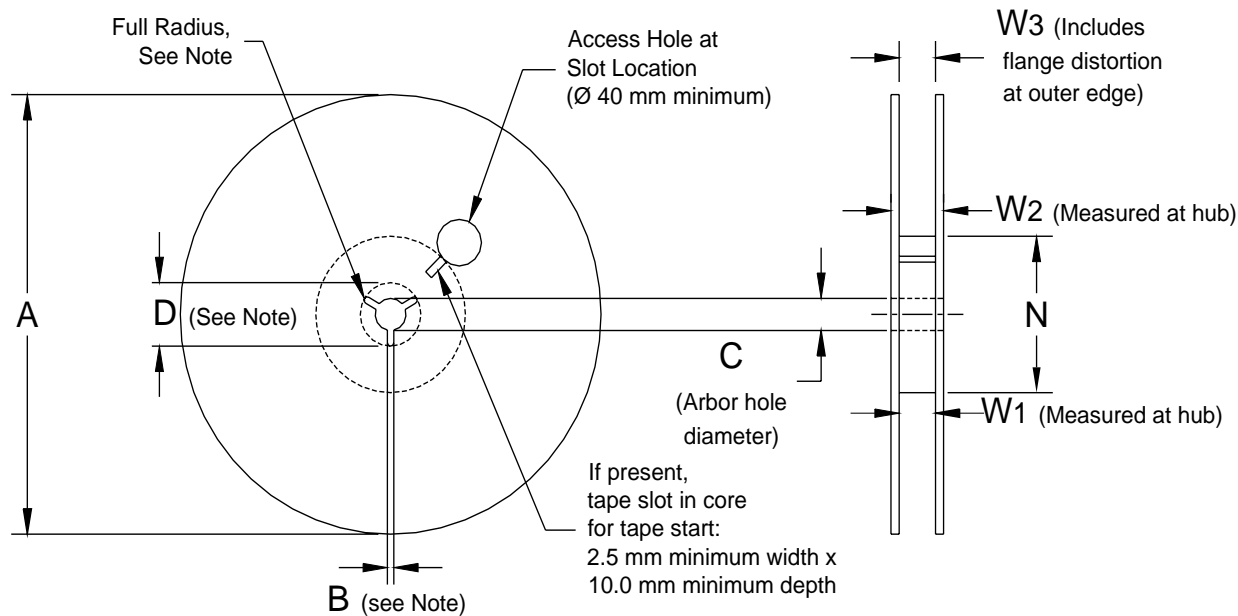

Figure 5 – Reel Dimensions



Note: Drive spokes optional; if used, dimensions B and D shall apply.

Table 5 – Reel Dimensions

Metric will govern

Constant Dimensions — Millimeters (Inches)				
Tape Size	A	B Minimum	C	D Minimum
8 mm	178 ±0.20 (7.008 ±0.008) or 330 ±0.20 (13.000 ±0.008)	1.5 (0.059)	13.0 +0.5/-0.2 (0.521 +0.02/-0.008)	20.2 (0.795)
12 mm				
16 mm				
Variable Dimensions — Millimeters (Inches)				
Tape Size	N Minimum	W ₁	W ₂ Maximum	W ₃
8 mm	50 (1.969)	8.4 +1.5/-0.0 (0.331 +0.059/-0.0)	14.4 (0.567)	Shall accommodate tape width without interference
12 mm		12.4 +2.0/-0.0 (0.488 +0.078/-0.0)	18.4 (0.724)	
16 mm		16.4 +2.0/-0.0 (0.646 +0.078/-0.0)	22.4 (0.882)	

Figure 6 – Tape Leader & Trailer Dimensions

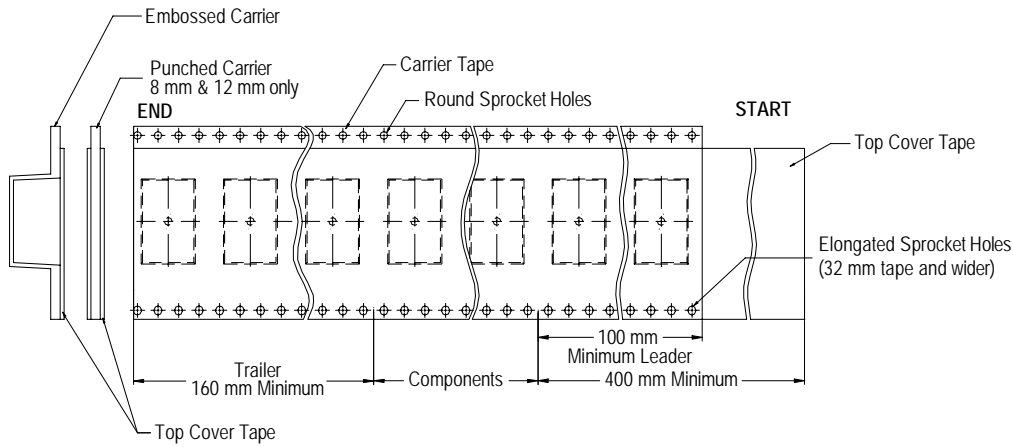
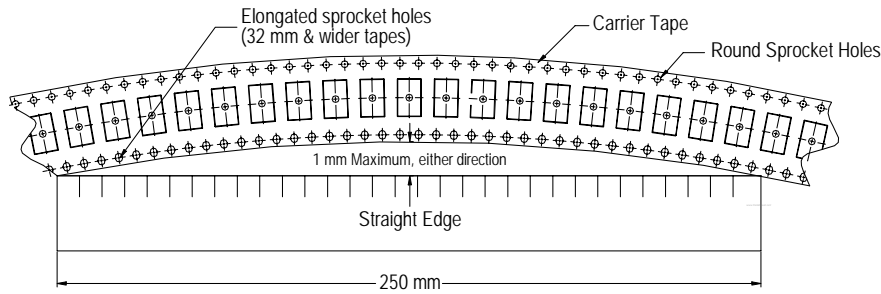

Figure 7 – Maximum Camber



KEMET Corporation World Headquarters

2835 KEMET Way
Simpsonville, SC 29681

Mailing Address:
P.O. Box 5928
Greenville, SC 29606

www.kemet.com
Tel: 864-963-6300
Fax: 864-963-6521

Corporate Offices

Fort Lauderdale, FL
Tel: 954-766-2800

North America

Southeast

Lake Mary, FL
Tel: 407-855-8886

Northeast

Wilmington, MA
Tel: 978-658-1663

West Chester, PA
Tel: 610-692-4642

Central

Novi, MI
Tel: 248-994-1030

Carmel, IN
Tel: 317-706-6742

West

Milpitas, CA
Tel: 408-433-9950

Mexico

Zapopan, Jalisco
Tel: 52-33-3123-2141

Europe

Southern Europe

Geneva, Switzerland
Tel: 41-22-715-0100

Paris, France
Tel: 33-1-4646-1009

Sasso Marconi, Italy
Tel: 39-051-939111

Milan, Italy
Tel: 39-02-57518176

Rome, Italy
Tel: 39-06-23231718

Madrid, Spain
Tel: 34-91-804-4303

Central Europe

Landsberg, Germany
Tel: 49-8191-3350800

Dortmund, Germany
Tel: 49-2307-3619672

Kwidzyn, Poland
Tel: 48-55-279-7025

Northern Europe

Bishop's Stortford, United Kingdom
Tel: 44-1279-757201

Weymouth, United Kingdom
Tel: 44-1305-830747

Coatbridge, Scotland
Tel: 44-1236-434455

Färjestaden, Sweden
Tel: 46-485-563934

Espoo, Finland
Tel: 358-9-5406-5000

Asia

Northeast Asia

Hong Kong
Tel: 852-2305-1168

Shenzhen, China
Tel: 86-755-2518-1306

Beijing, China
Tel: 86-10-5829-1711

Shanghai, China
Tel: 86-21-6447-0707

Taipei, Taiwan
Tel: 886-2-27528585

Southeast Asia

Singapore
Tel: 65-6586-1900

Penang, Malaysia
Tel: 60-4-6430200

Bangalore, India
Tel: 91-806-53-76817

Note: KEMET reserves the right to modify minor details of internal and external construction at any time in the interest of product improvement. KEMET does not assume any responsibility for infringement that might result from the use of KEMET Capacitors in potential circuit designs. KEMET is a registered trademark of KEMET Electronics Corporation.

Other KEMET Resources

Tools	
Resource	Location
Configure A Part: CapEdge	http://capacitoredge.kemet.com
SPICE & FIT Software	http://www.kemet.com/spice
Search Our FAQs: KnowledgeEdge	http://www.kemet.com/keask

Product Information	
Resource	Location
Products	http://www.kemet.com/products
Technical Resources (Including Soldering Techniques)	http://www.kemet.com/technicalpapers
RoHS Statement	http://www.kemet.com/rohs
Quality Documents	http://www.kemet.com/qualitydocuments

Product Request	
Resource	Location
Sample Request	http://www.kemet.com/sample
Engineering Kit Request	http://www.kemet.com/kits

Contact	
Resource	Location
Website	www.kemet.com
Contact Us	http://www.kemet.com/contact
Investor Relations	http://www.kemet.com/ir
Call Us	1-877-MyKEMET
Twitter	http://twitter.com/kemetcapacitors

Disclaimer

All product specifications, statements, information and data (collectively, the "Information") are subject to change without notice.

All Information given herein is believed to be accurate and reliable, but is presented without guarantee, warranty, or responsibility of any kind, expressed or implied.

Statements of suitability for certain applications are based on our knowledge of typical operating conditions for such applications, but are not intended to constitute – and we specifically disclaim – any warranty concerning suitability for a specific customer application or use. This Information is intended for use only by customers who have the requisite experience and capability to determine the correct products for their application. Any technical advice inferred from this Information or otherwise provided by us with reference to the use of our products is given gratis, and we assume no obligation or liability for the advice given or results obtained.

Although we design and manufacture our products to the most stringent quality and safety standards, given the current state of the art, isolated component failures may still occur. Accordingly, customer applications which require a high degree of reliability or safety should employ suitable designs or other safeguards (such as installation of protective circuitry or redundancies) in order to ensure that the failure of an electrical component does not result in a risk of personal injury or property damage.

Although all product-related warnings, cautions and notes must be observed, the customer should not assume that all safety measures are indicated or that other measures may not be required.

