

GaAs MMIC MEDIUM POWER AMPLIFIER, 17 - 40 GHz

Typical Applications

The HMC283 is ideal for:

- Millimeterwave Point-to-Point Radios
- VSAT
- SATCOM

Features

- High Gain: 21 dB
- Psat Output Power: +21 dBm
- Wideband Performance: 17 - 40 GHz
- Small Chip Size: 1.72 x 0.88 x 0.1 mm

Functional Diagram

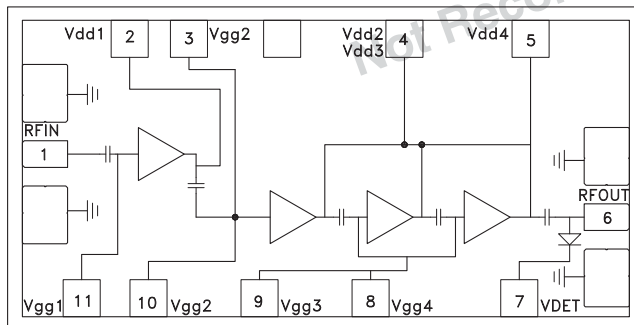

General Description

The HMC283 chip is a four stage GaAs MMIC Medium Power Amplifier (MPA) which covers the frequency range of 17 to 40 GHz. The chip can easily be integrated into Multi-Chip Modules (MCMs) due to its small size. The chip utilizes a GaAs PHEMT process offering 21 dB gain and +21 dBm output power from a bias supply of +3.5V @ 300 mA. The HMC283 may be used as a frequency doubler. A B.I.T. (Built-In-Test) pad (Vdet) allows monitoring microwave output power. All data is with the chip in a 50 ohm test fixture connected via 0.076 x 0.0127mm (3mil x 0.5mil) ribbon bonds of minimal length 0.31mm (<12mils).

Electrical Specifications, $T_A = +25^\circ \text{C}$, $V_{dd} = +3.5\text{V}^*$, $I_{dd} = 300 \text{ mA}$

Parameter	Min.	Typ.	Max.	Units
Frequency Range	17 - 40			GHz
Gain	16	21		dB
Gain Flatness (Any 1 GHz BW)		± 0.8		dB
Input Return Loss		9		dB
Output Return Loss		6		dB
Reverse Isolation	40	50		dB
Output Power for 1 dB Compression (P1dB)	14	18		dBm
Saturated Output Power (Psat)	17	21		dBm
Output Third Order Intercept (IP3)	21	26		dBm
Noise Figure		10	14	dB
Supply Current (Idd)(Vdd = +3.5V, Vgg = -0.15V Typ.)		300	400	mA

*Vdd = Vdd1, 2, 3, 4 connected to +3.5V, adjusting Vgg = Vgg1, 2, 3, 4 between -2.0 to +0.4V to achieve Idd = 300 mA typical.

**GaAs MMIC MEDIUM POWER
AMPLIFIER, 17 - 40 GHz**

Broadband Gain & Return Loss

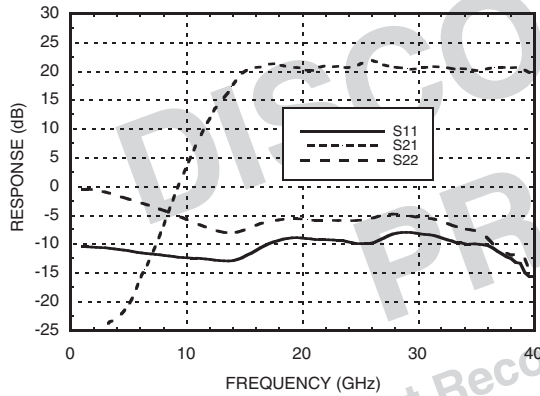

Gain vs. Temperature

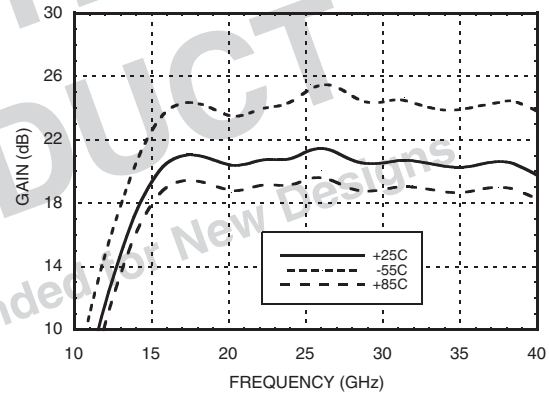

Reverse Isolation vs. Temperature

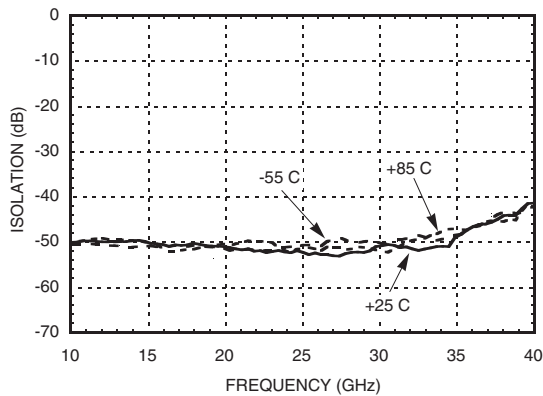

Input Return Loss vs. Temperature

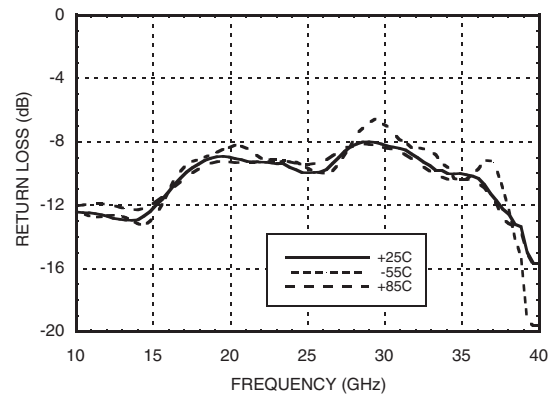

Noise Figure vs. Temperature

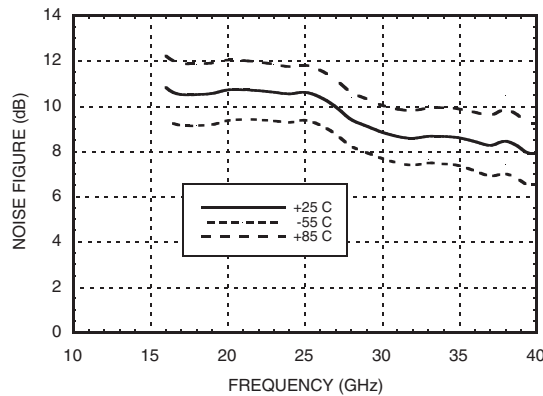

Output Return Loss vs. Temperature

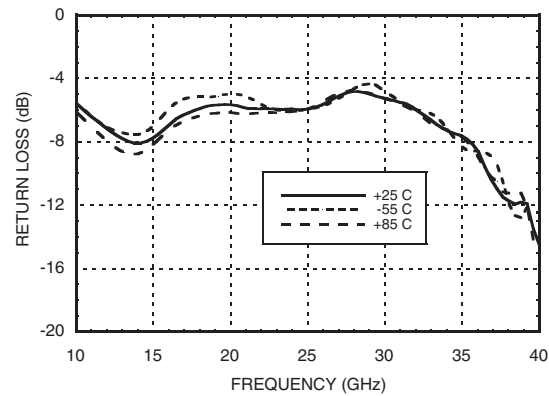

GaAs MMIC MEDIUM POWER AMPLIFIER, 17 - 40 GHz

Output P1dB vs. Temperature

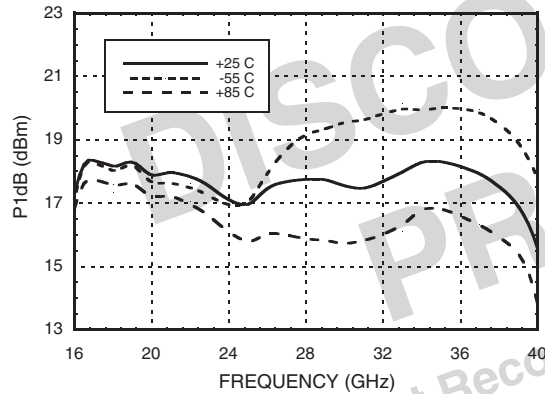

Power Compression @ 20 GHz

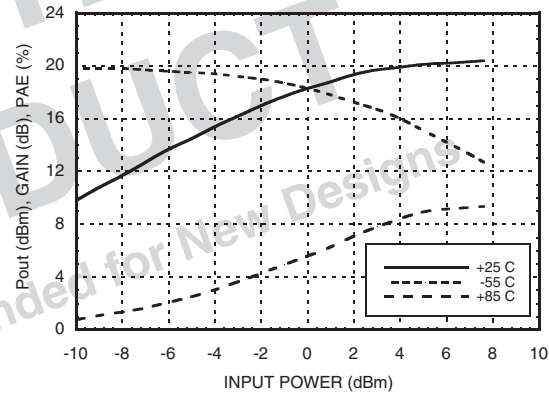

Output Psat vs. Temperature

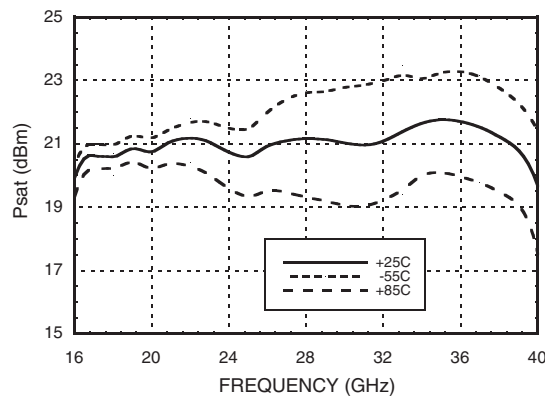

Power Compression @ 28 GHz

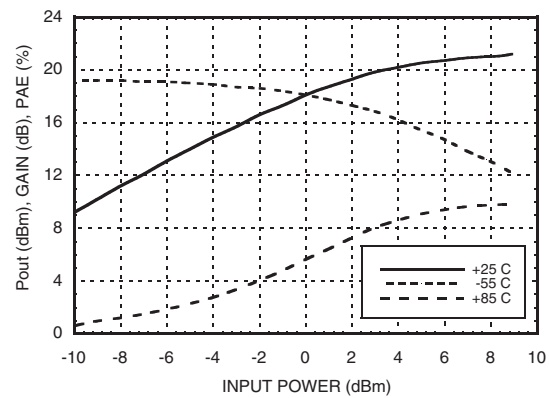

Output IP3 vs. Temperature

	Frequency (GHz)		
Temperature	20	28	38
-55 °C	25.6	25.4	28.6
+25 °C	27.5	25.9	27.1
+85 °C	27	24.4	25.7

All levels in dBm

Power Compression @ 39 GHz

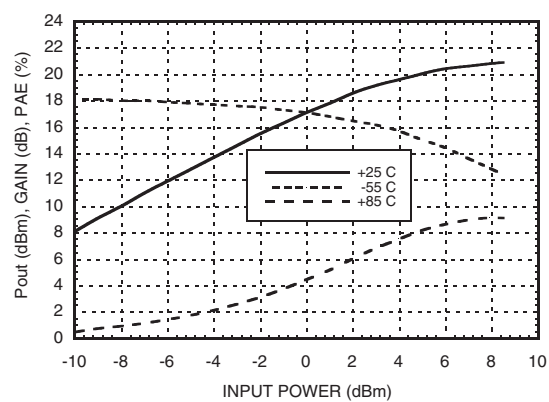

**GaAs MMIC MEDIUM POWER
AMPLIFIER, 17 - 40 GHz**

Absolute Maximum Ratings

Drain Bias Voltage (Vdd1, Vdd2, Vdd3, Vdd4)	+5Vdc
Drain Bias Current (Idd)	400 mA
Gate Bias Voltage (Vgg1, Vgg2, Vgg3, Vgg4)	-2 to +0.4Vdc
Gate Bias Current (Igg)	4 mA
RF Input Power (RFIN)(Vdd = +3.5 Vdc)	+8 dBm
Channel Temperature	175 °C
Continuous Pdiss (T = 85 °C) (derate 13.04 mW/°C above 85 °C)	1.174 W
Thermal Resistance (channel to die bottom)	76.7 °C/W
Storage Temperature	-65 to +150 °C
Operating Temperature	-55 to +85 °C



ELECTROSTATIC SENSITIVE DEVICE
OBSERVE HANDLING PRECAUTIONS

Outline Drawing

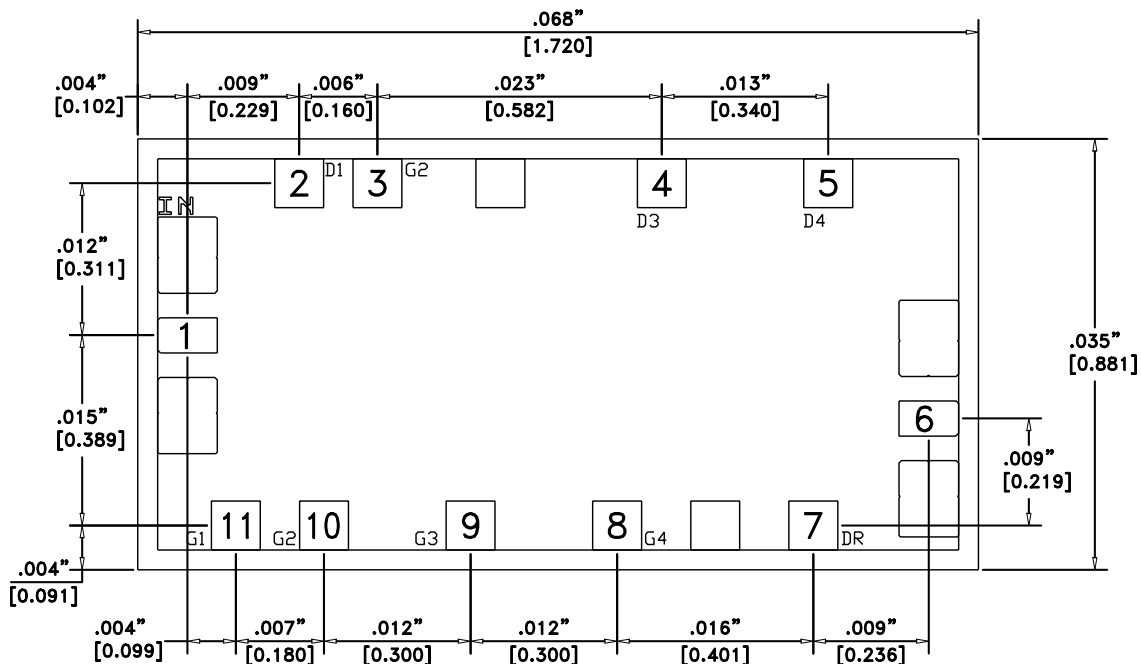

Die Packaging Information [1]

Standard	Alternate
GP-2	[2]

[1] Refer to the "Packaging Information" section for die packaging dimensions.





[2] For alternate packaging information contact Hittite Microwave Corporation.

NOTES:

- ALL DIMENSIONS ARE IN INCHES [MM]
- DIE THICKNESS IS .004"
- TYPICAL BOND IS .004" SQUARE
- BACKSIDE METALLIZATION: GOLD
- BOND PAD METALLIZATION: GOLD
- BACKSIDE METAL IS GROUND.
- CONNECTION NOT REQUIRED FOR UNLABELED BOND PADS.

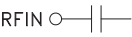
GaAs MMIC MEDIUM POWER AMPLIFIER, 17 - 40 GHz

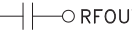
Pin Descriptions

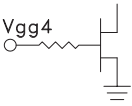
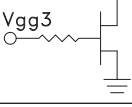
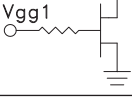
Pin Number	Function	Pin Description	Interface Schematic
1	RFIN	This pad is AC coupled and matched to 50 Ohms.	RFIN 
2	Vdd1	Power Supply Voltage for the amplifier. External bypass caps of 100pF and 0.1 μF are required.	
3, 10	Vgg2	Gate Control for amplifier. Adjust Vgg (= Vgg1, Vgg2, Vgg3, Vgg4) to achieve Idd = 300mA. External bypass caps of 100pF and 0.1 μF are required.	Vgg2 
4, 5	Vdd2, 3, 4	Power Supply Voltage for the amplifier. External bypass caps of 100pF and 0.1 μF are required.	
6	RFOUT	This pad is AC coupled and matched to 50 Ohms.	 RFOUT
7	V _{DET}	Output power verification pad.	V _{DET} 
8	Vgg4	Gate Control for amplifier. Adjust Vgg (= Vgg1, Vgg2, Vgg3, Vgg4) to achieve Idd = 300mA. External bypass caps of 100pF and 0.1 μF are required.	Vgg4 
9	Vgg3	Gate Control for amplifier. Adjust Vgg (= Vgg1, Vgg2, Vgg3, Vgg4) to achieve Idd = 300mA. External bypass caps of 100pF and 0.1 μF are required.	Vgg3 
11	Vgg1	Gate Control for amplifier. Adjust Vgg (= Vgg1, Vgg2, Vgg3, Vgg4) to achieve Idd = 300mA. External bypass caps of 100pF and 0.1 μF are required.	Vgg1 

**GaAs MMIC MEDIUM POWER
AMPLIFIER, 17 - 40 GHz**

Mounting & Bonding Techniques for Millimeterwave GaAs MMICs

The die should be attached directly to the ground plane eutectically or with conductive epoxy (see *HMC general Handling, Mounting, Bonding Note*).

50 Ohm Microstrip transmission lines on 0.127mm (5 mil) thick alumina thin film substrates are recommended for bringing RF to and from the chip (Figure 1). If 0.254mm (10 mil) thick alumina thin film substrates must be used, the die should be raised 0.150mm (6 mils) so that the surface of the die is coplanar with the surface of the substrate. One way to accomplish this is to attach the 0.102mm (4 mil) thick die to a 0.150mm (6 mil) thick molybdenum heat spreader (moly-tab) which is then attached to the ground plane (Figure 2).

Microstrip substrates should be brought as close to the die as possible in order to minimize bond wire length. Typical die-to-substrate spacing is 0.076mm to 0.152 mm (3 to 6 mils).

RF bypass capacitors should be used on the Vdd & Vgg inputs. 100pF single layer capacitors (mounted eutectically or by conductive epoxy) placed no further than 0.762 mm (30 mils) from the chip are recommended. The photo in figure 3 shows a typical assembly for the HMC283 MMIC chip.

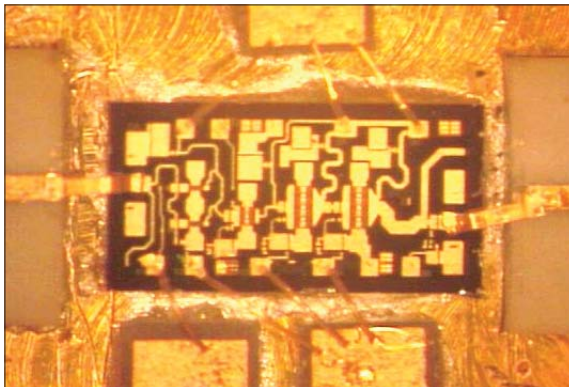
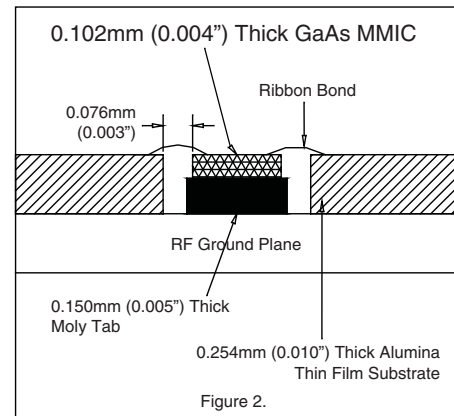
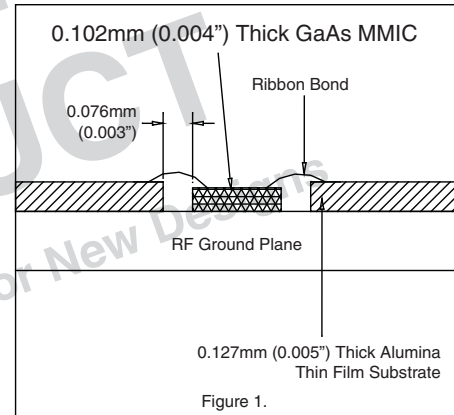

Figure 3: Typical HMC283 Assembly

Handling Precautions

Follow these precautions to avoid permanent damage.

Storage: All bare die are placed in either Waffle or Gel based ESD protective containers, and then sealed in an ESD protective bag for shipment. Once the sealed ESD protective bag has been opened, all die should be stored in a dry nitrogen environment.

Cleanliness: Handle the chips in a clean environment. DO NOT attempt to clean the chip using liquid cleaning systems.

Static Sensitivity: Follow ESD precautions to protect against ESD strikes.

Transients: Suppress instrument and bias supply transients while bias is applied. Use shielded signal and bias cables to minimize inductive pick-up.

General Handling: Handle the chip along the edges with a vacuum collet or with a sharp pair of bent tweezers. The surface of the chip may have fragile air bridges and should not be touched with vacuum collet, tweezers, or fingers.

GaAs MMIC MEDIUM POWER AMPLIFIER, 17 - 40 GHz

Mounting & Bonding Techniques for Millimeterwave GaAs MMICs

The die should be attached directly to the ground plane eutectically or with conductive epoxy (see *HMC general Handling, Mounting, Bonding Note*).

50 Ohm Microstrip transmission lines on 0.127mm (5 mil) thick alumina thin film substrates are recommended for bringing RF to and from the chip (Figure 1). If 0.254mm (10 mil) thick alumina thin film substrates must be used, the die should be raised 0.150mm (6 mils) so that the surface of the die is coplanar with the surface of the substrate. One way to accomplish this is to attach the 0.102mm (4 mil) thick die to a 0.150mm (6 mil) thick molybdenum heat spreader (moly-tab) which is then attached to the ground plane (Figure 2).

Microstrip substrates should be brought as close to the die as possible in order to minimize bond wire length. Typical die-to-substrate spacing is 0.076mm to 0.152 mm (3 to 6 mils).

RF bypass capacitors should be used on the Vdd & Vgg inputs. 100pF single layer capacitors (mounted eutectically or by conductive epoxy) placed no further than 0.762 mm (30 mils) from the chip are recommended. The photo in figure 3 shows a typical assembly for the HMC283 MMIC chip.

Mounting

The chip is back-metallized and can be die mounted with AuSn eutectic preforms or with electrically conductive epoxy. The mounting surface should be clean and flat.

Eutectic Die Attach: A 80/20 gold tin preform is recommended with a work surface temperature of 255 °C and a tool temperature of 265 °C. When hot 90/10 nitrogen/hydrogen gas is applied, tool tip temperature should be 290 °C. DO NOT expose the chip to a temperature greater than 320 °C for more than 20 seconds. No more than 3 seconds of scrubbing should be required for attachment.

Epoxy Die Attach: Apply a minimum amount of epoxy to the mounting surface so that a thin epoxy fillet is observed around the perimeter of the chip once it is placed into position. Cure epoxy per the manufacturer's schedule.

Wire Bonding

Ball or wedge bond with 0.025mm (1 mil) diameter pure gold wire (DC Bias) or ribbon bond (RF ports) 0.076mm x 0.013mm (3 mil x 0.5 mil) size is recommended. Thermosonic wirebonding with a nominal stage temperature of 150 °C and a ball bonding force of 40 to 50 grams or wedge bonding force of 18 to 22 grams is recommended. Use the minimum level of ultrasonic energy to achieve reliable wirebonds. Wirebonds should be started on the chip and terminated on the package or substrate. All bonds should be as short as possible <0.31mm (12 mils).

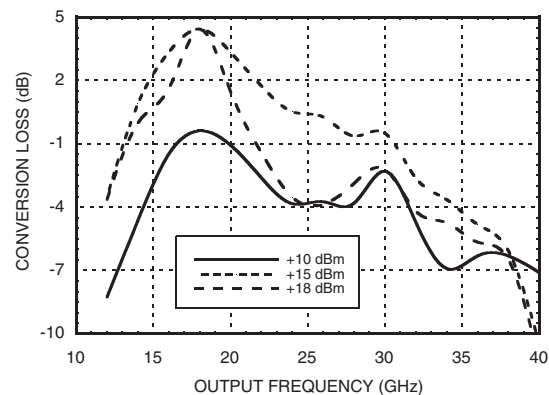

HMC283 Alternate Applications:

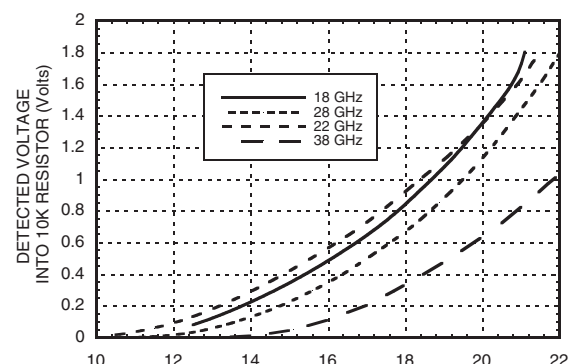
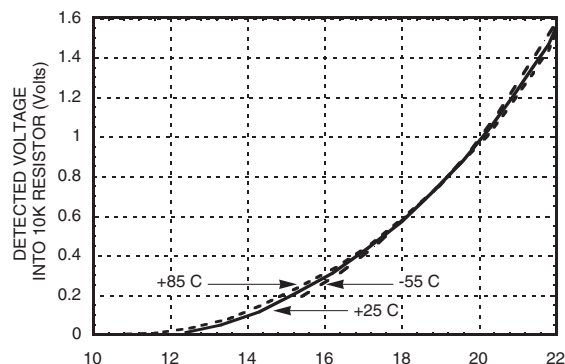

Notes:

**DISCONTINUED
PRODUCT**
Not Recommended for New Designs