

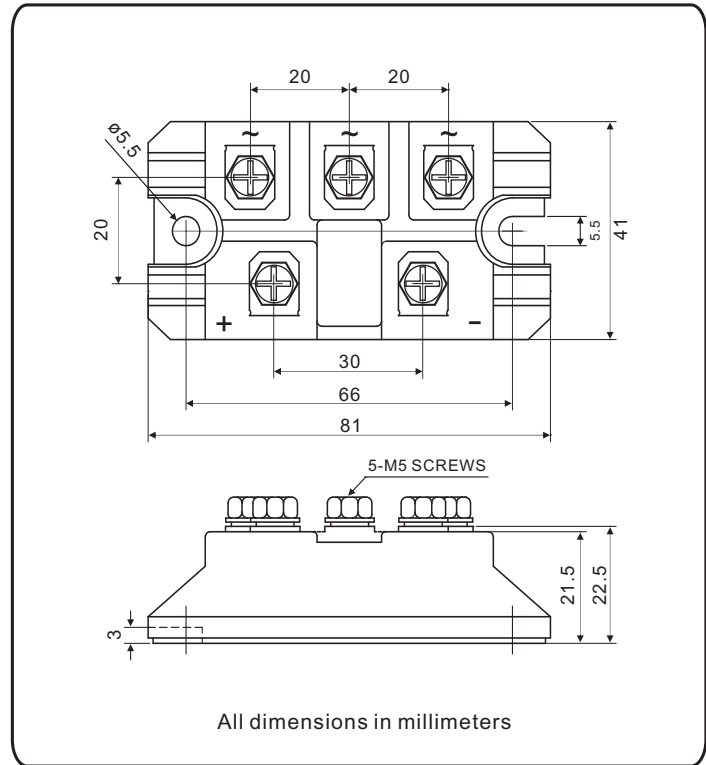

Three-Phase Bridge Rectifier, 100A MTP10008A Thru MTP10016A



FEATURES

- UL recognition file number E320098 
- Typical IR less than 2.0 μA
- High surge current capability
- Low thermal resistance
- Compliant to RoHS 
- Isolation voltage up to 2500V

TYPICAL APPLICATIONS

General purpose use in AC/DC bridge full wave rectification for big power supply, field supply for DC motor, industrial automation applications.

ADVANTAGE

- International standard package
Epoxy meets UL 94 V-O flammability rating
- Small volume, light weight
- Small thermal resistance
- **Weight:** 195g (6.9 ozs)

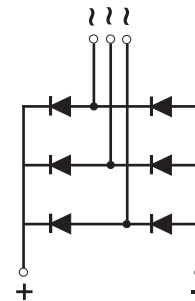

PRIMARY CHARACTERISTICS	
$I_{F(AV)}$	100A
V_{RRM}	800V to 1800V
I_{FSM}	1200A
I_R	20 μA
V_F	1.3V
$T_{Jmax.}$	150°C

MAJOR RATINGS AND CHARACTERISTICS ($T_A = 25^\circ\text{C}$ unless otherwise noted)							
PARAMETER	SYMBOL	MTP100..A					UNIT
		08	10	12	16	18	
Maximum repetitive peak reverse voltage	V_{RRM}	800	1000	1200	1600	1800	V
Peak reverse non-repetitive voltage	V_{RSM}	900	1100	1300	1700	1900	V
Maximum DC blocking voltage	V_{DC}	800	1000	1200	1600	1800	V
Maximum average forward rectified output current	$I_{F(AV)}$	100					A
Peak forward surge current single sine-wave superimposed on rated load	I_{FSM}	1200					A
Rating (non-repetitive, for t greater than 1 ms and less than 8.3 ms) for fusing	I^2t	7200					A ² s
RMS isolation voltage from case to leads	V_{ISO}	2500					V
Operating junction storage temperature range	T_J	-40 to 150					°C
Storage temperature range	T_{STG}	-40 to 125					°C

ELECTRICAL CHARACTERISTICS ($T_A = 25^\circ\text{C}$ unless otherwise noted)								
PARAMETER	TEST CONDITIONS	SYMBOL	MTP100..A					UNIT
			08	10	12	16	18	
Maximum instantaneous forward drop per diode	$I_F = 100\text{A}$	V_F	1.3					V
Maximum reverse DC current at rated DC blocking voltage per diode	$T_A = 25^\circ\text{C}$	I_R	20					μA
	$T_A = 150^\circ\text{C}$		4000					

THERMAL AND MECHANICAC ($T_A = 25^\circ\text{C}$ unless otherwise noted)								
PARAMETER	TEST CONDITIONS	SYMBOL	MTP100..A					UNIT
			08	10	12	16	18	
Typical thermal resistance junction to case	Single-side heat dissipation, sine half wave	$R_{\theta JC}^{(1)}$	0.2					°C/W
Mounting torque $\pm 10\%$ to heatsink, M5 to heatsink, M5	A mounting compound is recommended and the torque should be rechecked after a period of 3 hours to allow for the spread of the compound.		4					Nm
			4					
Approximate weight			195					g

Notes

- (1) With heatsink, single side heat dissipation, half sine wave.
- (2) M5 screw.

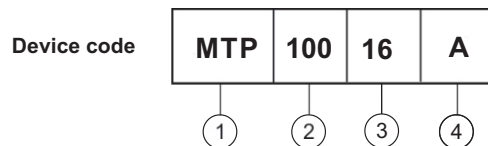

- ① - Module type: "MTP" for 3Ø Bridge
- ② - $I_{F(AV)}$ rating: "100" for 100A
- ③ - Voltage code: code x 100 = V_{RRM}
- ④ - Package Outline: A type package

Fig.1 Forward characteristic

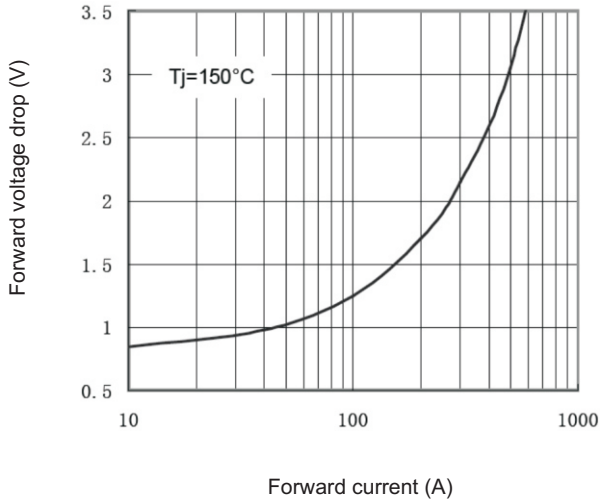

Fig.2 Thermal Impedance (junction to case)

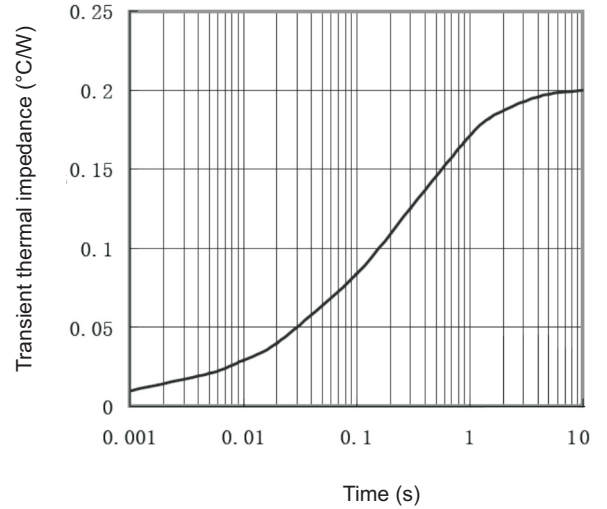

Fig.3 Power dissipation vs. output current

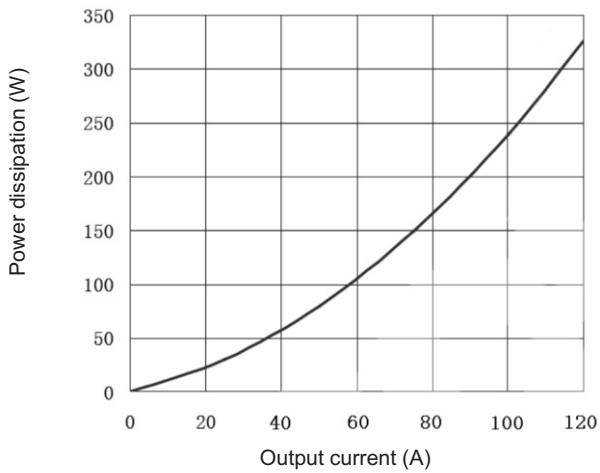

Fig.4 Case temperature vs. output current

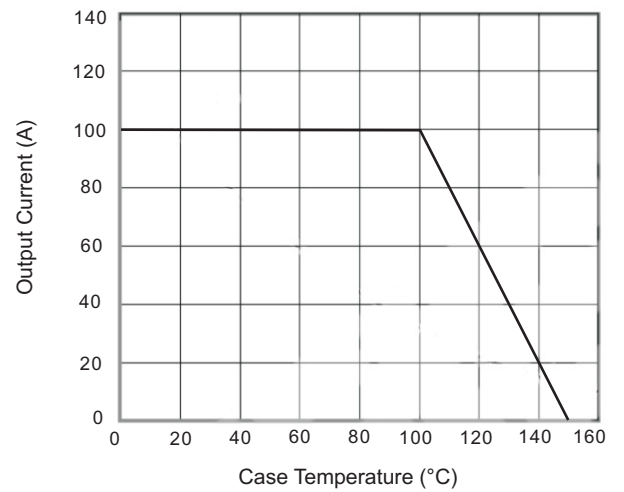

Fig.5 Forward surge current vs. cycle

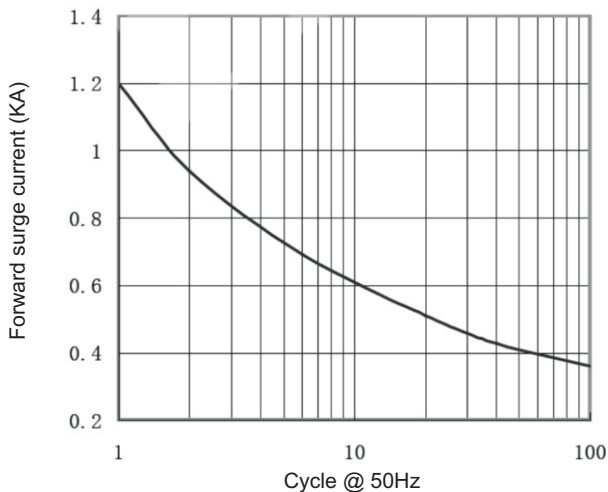

Fig.6 I²t characteristic

