

100V, 2A Peak, High Frequency Half-Bridge Drivers with Rising Edge Delay Timer

HIP2122, HIP2123

The HIP2122 and HIP2123 are 100V, high frequency, half-bridge MOSFET driver ICs. They are based on the popular ISL2100A and ISL2101A half-bridge drivers. Like the ISL2100A, two logic inputs, LI and HI, control both bridge outputs, LO and HO. All logic inputs are V_{DD} tolerant.

These drivers have a programmable dead-time to insure break-before-make operation between the high-side and low-side drivers. The dead-time is adjustable up to 220ns. The internal logic does not prevent both outputs from turning on simultaneously if both inputs are high simultaneously for a time greater than the programmed delay.

A single PWM logic input controls both bridge outputs (HO, LO). An enable pin (EN), when low, drives both outputs to a low state. All logic inputs are V_{DD} tolerant and the HIP2122 has CMOS inputs with hysteresis for superior operation in noisy environments.

The HIP2122 has hysteretic inputs with thresholds that are proportional to V_{DD} . The HIP2123 has 3.3V logic/TTL compatible inputs.

Two package options are provided. The 10 lead 4x4 DFN package has standard pinouts. The 9 lead 4x4 DFN package omits pin 2 to comply with 100V conductor spacing per IPC-2221.

Features

- 9 Ld TDFN “B” Package Compliant with 100V Conductor Spacing Guidelines per IPC-2221
- Break-Before-Make Dead-Time Prevents Shoot-through and is adjustable up to 220ns
- Bootstrap Supply Max Voltage to 114VDC
- Wide Supply Voltage Range (8V to 14V)
- Supply Undervoltage Protection
- CMOS Compatible Input Thresholds with Hysteresis (HIP2122)
- 1.6Ω/1Ω Typical Output Pull-up/Pull-down Resistance
- On-Chip 1Ω Bootstrap Diode

Applications

- Telecom Half-Bridge DC/DC Converters
- UPS and Inverters
- Motor Drives
- Class-D Amplifiers
- Forward Converter with Active Clamp

Related Literature

- [FN7668](#), HIP2120, HIP2121 “100V, 2A Peak, High Frequency Half-Bridge Drivers with Adjustable Dead Time Control and PWM Input”

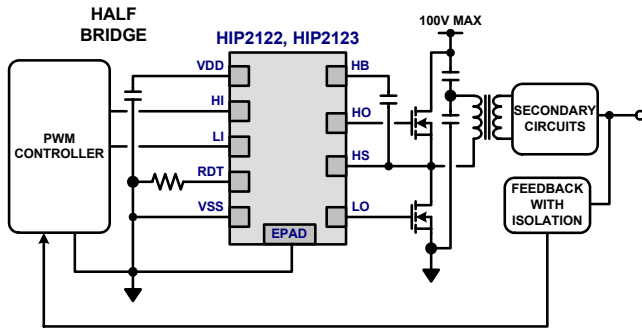

FIGURE 1. TYPICAL APPLICATION

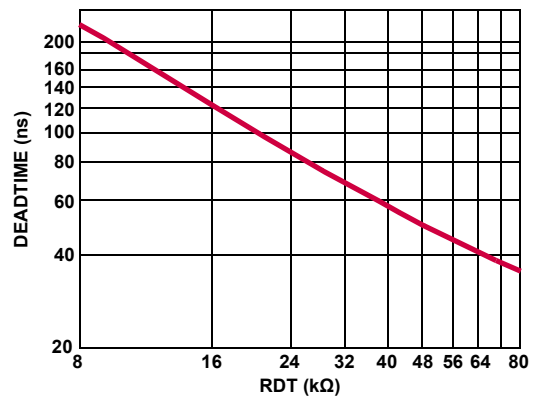
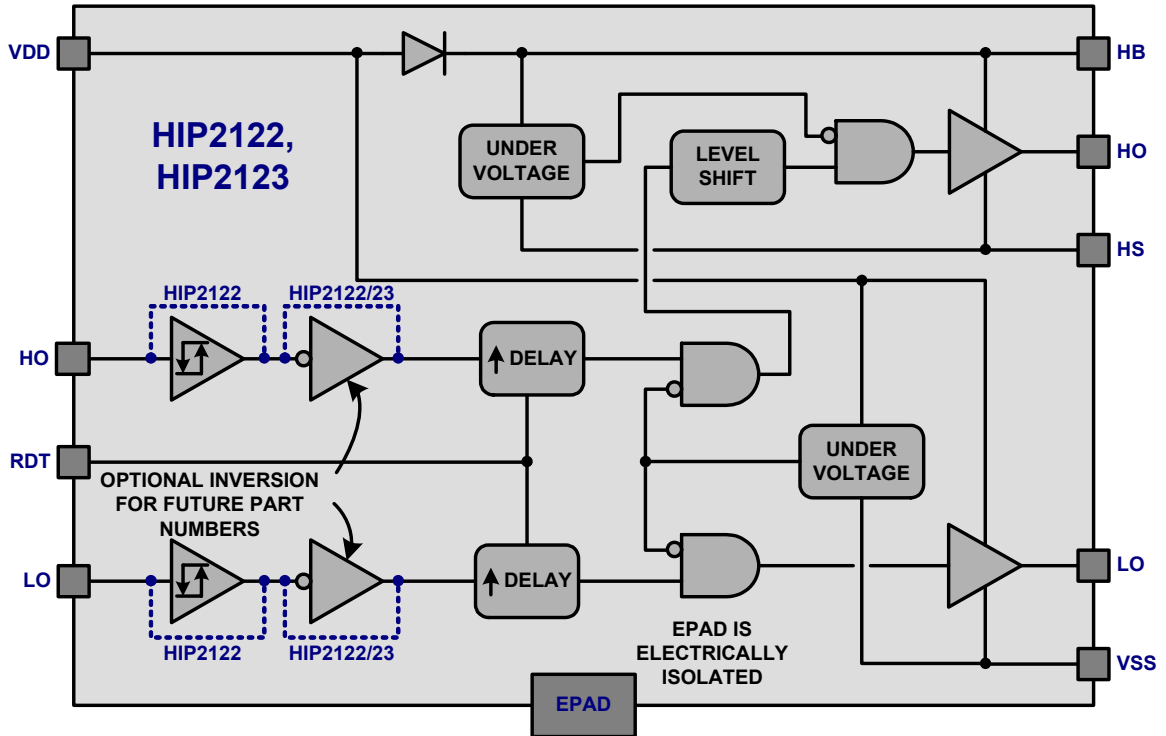

FIGURE 2. DEAD-TIME vs TIMING RESISTOR

HIP2122, HIP2123

Block Diagram



Pin Configurations

HIP2122, HIP2123
(10 LD 4X4 TDFN)
TOP VIEW

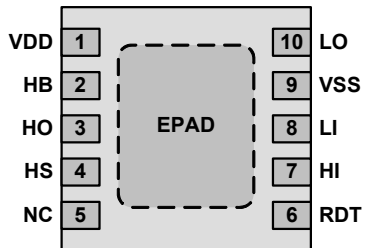

HIP2122, HIP2123
(9 LD 4X4 TDFN)
TOP VIEW

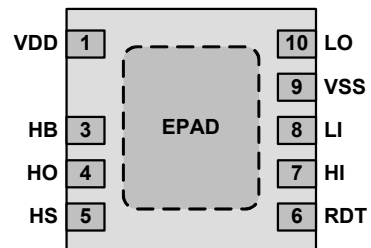

HIP2122, HIP2123

Pin Descriptions

9 LD TDFN	10 LD TDFN	SYMBOL	DESCRIPTION
1	1	VDD	Positive supply voltage for lower gate driver. Decouple this pin with a ceramic capacitor to VSS.
3	2	HB	High-side bootstrap supply voltage referenced to HS. Connect the positive side of bootstrap capacitor to this pin. Bootstrap diode is on-chip.
4	3	HO	High-side output. Connect to gate of high-side power MOSFET.
5	4	HS	High-side source connection. Connect to source of high-side power MOSFET. Connect the negative side of bootstrap capacitor to this pin.
8	8	LI	Low side driver input. For LI = 1, LO = 1 after programmed delay time; for LI = 0, LO = 0 with minimal delay.
7	7	HI	High side driver input. For HI = 1, HO = 1 after programmed delay time; for Hi = 0, HO = 0 with minimal delay.
9	9	VSS	Negative supply input, which will generally be ground.
10	10	LO	Low-side output. Connect to gate of low-side power MOSFET.
-	5	NC	No Connect. This pin is isolated from all other pins.
6	6	RDT	A resistor connected between this pin and VSS adds additional delay time to the normal rising edge propagation delay.
-	-	EPAD	Exposed pad. Connect to ground or float. The EPAD is electrically isolated from all other pins.

Ordering Information

PART NUMBER (Notes 1, 2, 4)	PART MARKING	INPUT	TEMP. RANGE (°C)	PACKAGE (Pb-Free)	PKG. DWG. #
HIP2122FRTAZ	HIP 2122AZ	CMOS	- 40 to +125	10 Ld 4x4 TDFN	L10.4x4
HIP2123FRTAZ	HIP 2123AZ	3.3V/TTL	- 40 to +125	10 Ld 4x4 TDFN	L10.4x4
HIP2122FRTBZ (Note 3)	HIP 2122BZ	CMOS	- 40 to +125	9 Ld 4x4 TDFN	L9.4x4
HIP2123FRTBZ (Note 3)	HIP 2123BZ	3.3V/TTL	- 40 to +125	9 Ld 4x4 TDFN	L9.4x4

NOTES:

1. Add "-T*" suffix for tape and reel. Please refer to [TB347](#) for details on reel specifications.
2. These Intersil Pb-free plastic packaged products employ special Pb-free material sets, molding compounds/die attach materials, and 100% matte tin plate plus anneal (e3 termination finish, which is RoHS compliant and compatible with both SnPb and Pb-free soldering operations). Intersil PbHfree products are MSL classified at Pb-free peak reflow temperatures that meet or exceed the Pb-free requirements of IPC/JEDEC J STD-020.
3. "B" package option has alternate pin assignments for compliance with 100V Conductor Spacing Guidelines per IPC-2221. Note that Pin 2 is omitted for additional spacing.
4. For Moisture Sensitivity Level (MSL), please see device information page for [HIP2122](#), [HIP2123](#). For more information on MSL please see tech brief [TB363](#).

Table of Contents

Absolute Maximum Ratings	5
Thermal Information	5
Maximum Recommended Operating Conditions	5
ESD Ratings	5
Electrical Specifications	5
Switching Specifications	7
Timing Diagram	7
Typical Performance Curves	8
Functional Description	11
Functional Overview	11
Application Information	11
Selecting the Boot Capacitor Value	11
Typical Application Circuit	12
Transients on HS Node	12
Power Dissipation	13
PC Board Layout	13
EPAD Design Considerations	13
Revision History	14
Products	14
Package Outline Drawing	15
Package Outline Drawing	16

HIP2122, HIP2123

Absolute Maximum Ratings

Supply Voltage, V_{DD} , $V_{HB} - V_{HS}$ (Notes 5, 6)	-0.3V to 18V
LI and HI Input Voltage (Note 6)	-0.3V to $V_{DD} + 0.3V$
Voltage on LO (Note 6)	-0.3V to $V_{DD} + 0.3V$
Voltage on HO (Note 6)	$V_{HS} - 0.3V$ to $V_{HB} + 0.3V$
Voltage on HS (Continuous) (Note 6)	-1V to 110V
Voltage on HB (Note 6)	118V
Average Current in V_{DD} to HB Diode	100mA

Maximum Recommended Operating Conditions

Supply Voltage, V_{DD}	8V to 14V
Voltage on HS	-1V to 100V
Voltage on HS (Repetitive Transient)	-5V to 105V
Voltage on HB	$V_{HS} + 8V$ to $V_{HS} + 14V$ and $V_{DD} - 1V$ to $V_{DD} + 100V$
HS Slew Rate	<50V/ns

CAUTION: Do not operate at or near the maximum ratings listed for extended periods of time. Exposure to such conditions may adversely impact product reliability and result in failures not covered by warranty.

NOTES:

- The HIP2122 and HIP2123 are capable of derated operation at supply voltages exceeding 14V. Figure 20 shows the high-side voltage derating curve for this mode of operation.
- All voltages referenced to V_{SS} unless otherwise specified.
- θ_{JA} is measured in free air with the component mounted on a high effective thermal conductivity test board with "direct attach" features. See Tech Brief [TB379](#).
- For θ_{JC} , the "case temp" location is the center of the exposed metal pad on the package underside.

Thermal Information

Thermal Resistance (Typical)	θ_{JA} ($^{\circ}C/W$)	θ_{JC} ($^{\circ}C/W$)
10 Ld TDFN (Notes 7, 8)	42	4
9 Ld TDFN (Notes 7, 8)	42	4
Max Power Dissipation at +25 $^{\circ}C$ in Free Air		
10 Ld TDFN (Notes 7, 8)	3.0W	
9 Ld TDFN (Notes 7, 8)	3.1W	
Storage Temperature Range	-65 $^{\circ}C$ to +150 $^{\circ}C$	
Junction Temperature Range	-55 $^{\circ}C$ to +150 $^{\circ}C$	
Pb-free reflow profile	see link below	
	http://www.intersil.com/pbfree/Pb-FreeReflow.asp	

ESD Ratings

Human Body Model Class 2 (Tested per JESD22-A114E)	3000V
Machine Model Class B (Tested per JESD22-A115-A)	300V
Charged Device Model Class IV	2000V

Electrical Specifications $V_{DD} = V_{HB} = 12V$, $V_{SS} = V_{HS} = 0V$, $R_{DT} = 0\Omega$, $PWM = 0V$, No Load on LO or HO, Unless Otherwise Specified. Boldface limits apply over the operating temperature range, -40 $^{\circ}C$ to +125 $^{\circ}C$.

PARAMETERS	SYMBOL	TEST CONDITIONS	$T_A = +25^{\circ}C$			$T_A = -40^{\circ}C$ to +125 $^{\circ}C$		UNITS
			MIN	TYP	MAX	MIN (Note 9)	MAX (Note 9)	
SUPPLY CURRENTS								
V_{DD} Quiescent Current	I_{DD80}	$R_{DT} = 80k$	-	470	850	-	900	μA
	I_{DD8k}	$R_{DT} = 8k$	-	1.0	2.1	-	2.2	mA
V_{DD} Operating Current	I_{DD080k}	$f = 500kHz$, $R_{DT} = 80k$	-	2.5	3	-	3	mA
	I_{DD08k}	$f = 500kHz$, $R_{DT} = 8k$	-	3.4	4	-	4	mA
Total HB Quiescent Current	I_{HB}	LI = HI = 0V	-	65	115	-	150	μA
Total HB Operating Current	I_{HB0}	$f = 500kHz$	-	2.0	2.5	-	3	mA
HB to V_{SS} Current, Quiescent	I_{HBS}	LI = HI = 0V; $V_{HB} = V_{HS} = 114V$	-	0.05	1.5	-	10	μA
HB to V_{SS} Current, Operating	I_{HBS0}	$f = 500kHz$; $V_{HB} = V_{HS} = 114V$	-	1.2	1.5	-	1.6	mA
INPUT PINS								
Low Level Input Voltage Threshold	V_{IL}	HIP2122 (CMOS)	3.7	4.4	-	2.7	-	V
Low Level Input Voltage Threshold	V_{IL}	HIP2123 (3.3V/TTL)	1.4	1.8	-	1.2	-	V
High Level Input Voltage Threshold	V_{IH}	HIP2122 (CMOS)	-	6.54	7.93	5.3	8.2	V
High Level Input Voltage Threshold	V_{IH}	HIP2123 ((3.3V/TTL)	-	1.8	2.2	-	2.4	V

HIP2122, HIP2123

Electrical Specifications $V_{DD} = V_{HB} = 12V$, $V_{SS} = V_{HS} = 0V$, $R_{DT} = 0\Omega$, PWM = 0V, No Load on LO or HO, Unless Otherwise Specified.
Boldface limits apply over the operating temperature range, -40°C to +125°C.

PARAMETERS	SYMBOL	TEST CONDITIONS	$T_A = +25^\circ\text{C}$			$T_A = -40^\circ\text{C to } +125^\circ\text{C}$		UNITS
			MIN	TYP	MAX	MIN (Note 9)	MAX (Note 9)	
Input Voltage Hysteresis	V_{IHYS}	HIP2122 (CMOS)	-	2.2	-	-	-	V
Input Pull-down Resistance	R_I		-	210	-	100	500	k Ω
UNDERVOLTAGE PROTECTION								
V_{DD} Rising Threshold	V_{DDR}		6.8	7.3	7.8	6.5	8.1	V
V_{DD} Threshold Hysteresis	V_{DDH}		-	0.6	-	-	-	V
HB Rising Threshold	V_{HBR}		6.2	6.9	7.5	5.9	7.8	V
HB Threshold Hysteresis	V_{HBH}		-	0.6	-	-	-	V
BOOTSTRAP DIODE								
Low Current Forward Voltage	V_{DL}	$I_{VDD-HB} = 100\text{mA}$	-	0.6	0.7	-	0.8	V
High Current Forward Voltage	V_{DH}	$I_{VDD-HB} = 100\text{mA}$	-	0.7	0.9	-	1	V
Dynamic Resistance	R_D	$I_{VDD-HB} = 100\text{mA}$	-	0.8	1	-	1.5	Ω
LO GATE DRIVER								
Low Level Output Voltage	V_{OLL}	$I_{LO} = 100\text{mA}$	-	0.25	0.4	-	0.5	V
High Level Output Voltage	V_{OHL}	$I_{LO} = -100\text{mA}$, $V_{OHL} = V_{DD} - V_{LO}$	-	0.25	0.4	-	0.5	V
Peak Pull-Up Current	I_{OHL}	$V_{LO} = 0V$	-	2	-	-	-	A
Peak Pull-Down Current	I_{OLL}	$V_{LO} = 12V$	-	2	-	-	-	A
HO GATE DRIVER								
Low Level Output Voltage	V_{OLH}	$I_{HO} = 100\text{mA}$	-	0.25	0.4	-	0.5	V
High Level Output Voltage	V_{OHH}	$I_{HO} = -100\text{mA}$, $V_{OHH} = V_{HB} - V_{HO}$	-	0.25	0.4	-	0.5	V
Peak Pull-Up Current	I_{OHH}	$V_{HO} = 0V$	-	2	-	-	-	A
Peak Pull-Down Current	I_{OLH}	$V_{HO} = 12V$	-	2	-	-	-	A

HIP2122, HIP2123

Switching Specifications $V_{DD} = V_{HB} = 12V$, $V_{SS} = V_{HS} = 0V$, $R_{DT} = 0k\Omega$, No Load on LO or HO, Unless Otherwise Specified.

PARAMETERS (see "Timing Diagram")	SYMBOL	TEST CONDITIONS	$T_J = +25^\circ C$			$T_J = -40^\circ C \text{ to } +125^\circ C$		UNITS
			MIN	TYPE	MAX	MIN (Note 9)	MAX (Note 9)	
HO Turn-Off Propagation Delay HI Falling to HO Falling	t_{PLHO}		-	32	50	-	60	ns
LO Turn-Off Propagation Delay LO Falling to LO Falling	t_{PLLO}		-	32	50	-	60	ns
Minimum Dead-Time Delay (see Note 10) HO Falling to LO Rising	$t_{DTHLmin}$	$R_{DT} = 80k$, HI 1 to 0, LI 0 to 1	15	35	50	10	60	ns
Minimum Dead-Time Delay (see Note 10) LO Falling to HO Rising	$t_{DTLHmin}$	$R_{DT} = 80k$ LI 1 to 0, HI 0 to 1	15	25	50	10	60	ns
Maximum Dead-Rising Delay (see Note 10) HO Falling to LO rising	$t_{DTHLmax}$	$R_{DT} = 8k$, HI 1 to 0, LI 0 to 1	150	220	300	-	-	ns
Maximum Dead-Time Delay (see Note 10) LO Falling to HO Rising	$t_{DTLHmax}$	$R_{DT} = 8k$, LI 1 to 0, HI 0 to 1	150	220	300	-	-	ns
Either Output Rise/Fall Time (10% to 90%/90% to 10%)	t_{RC}, t_{FC}	$C_L = 1nF$	-	10	-	-	-	ns
Either Output Rise/Fall Time (3V to 9V/9V to 3V)	t_R, t_F	$C_L = 0.1mF$	-	0.5	0.6	-	0.8	μs
Bootstrap Diode Turn-On or Turn-Off Time	t_{BS}		-	10	-	-	-	ns

NOTES:

- Parameters with MIN and/or MAX limits are 100% tested at +25°C, unless otherwise specified. Temperature limits are established by characterization and are not production tested.
- Dead-Time is defined as the period of time between the LO falling and HO rising or between HO falling and LO rising when the LI and HI inputs transition simultaneously.

Timing Diagram

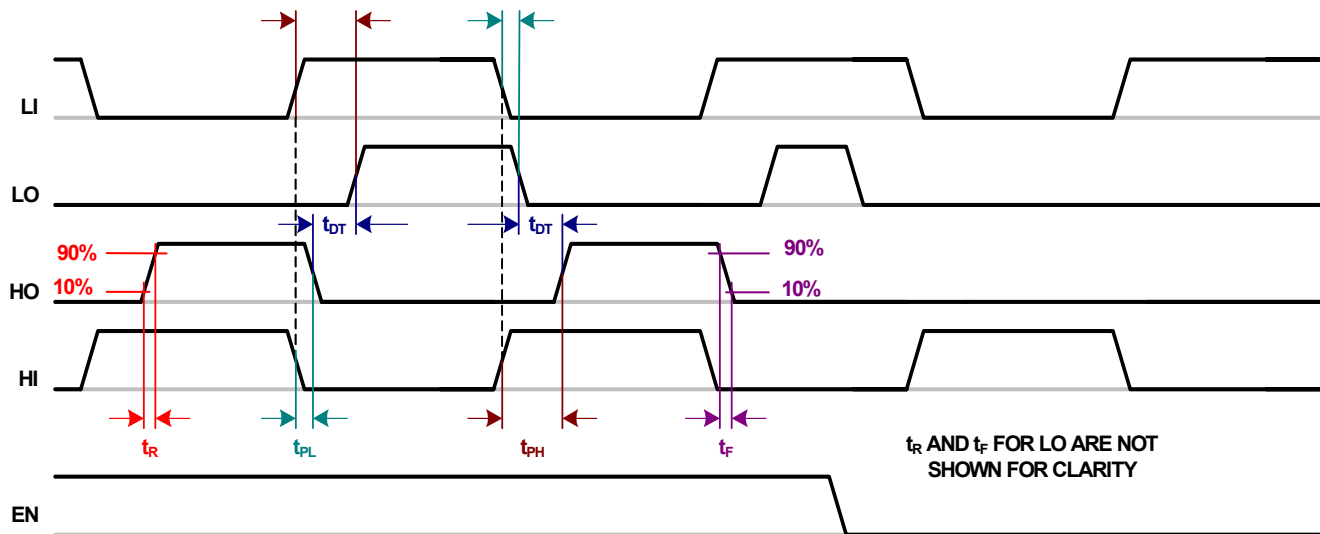

Typical Performance Curves

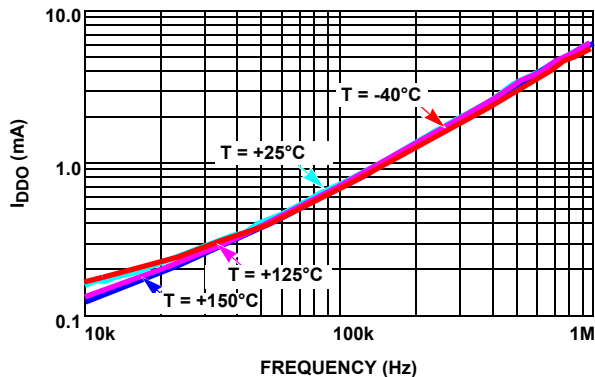

FIGURE 3. HIP2122 I_{DDQ} OPERATING CURRENT vs FREQUENCY

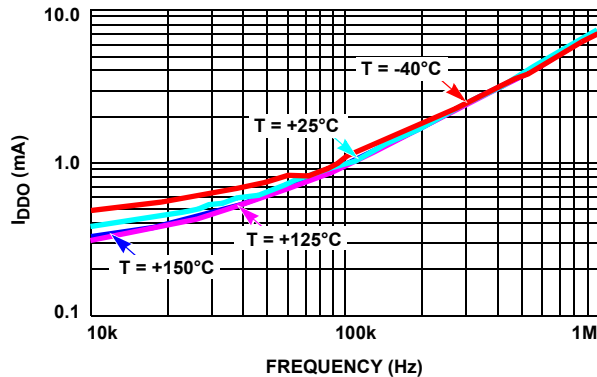

FIGURE 4. HIP2123 I_{DDQ} OPERATING CURRENT vs FREQUENCY

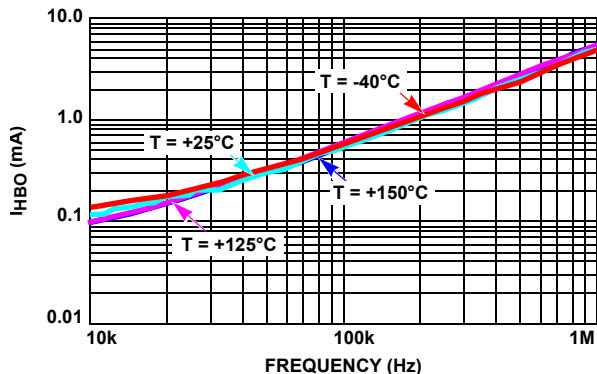

FIGURE 5. I_{HB} OPERATING CURRENT vs FREQUENCY

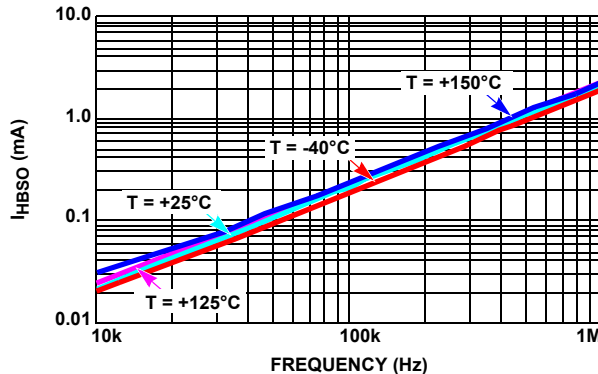

FIGURE 6. I_{HBS} OPERATING CURRENT vs FREQUENCY

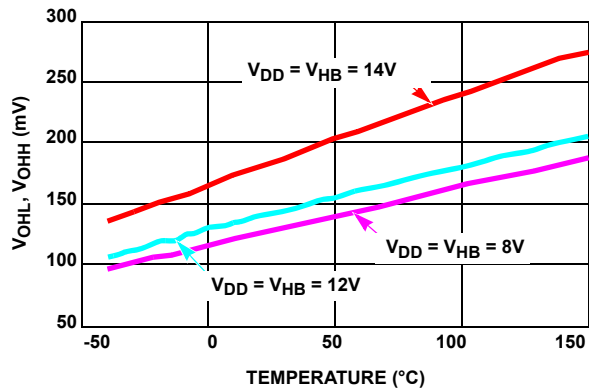

FIGURE 7. HIGH LEVEL OUTPUT VOLTAGE vs TEMPERATURE

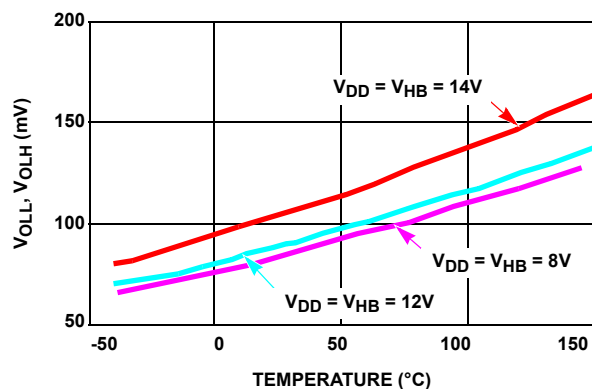

FIGURE 8. LOW LEVEL OUTPUT VOLTAGE vs TEMPERATURE

HIP2122, HIP2123

Typical Performance Curves (Continued)

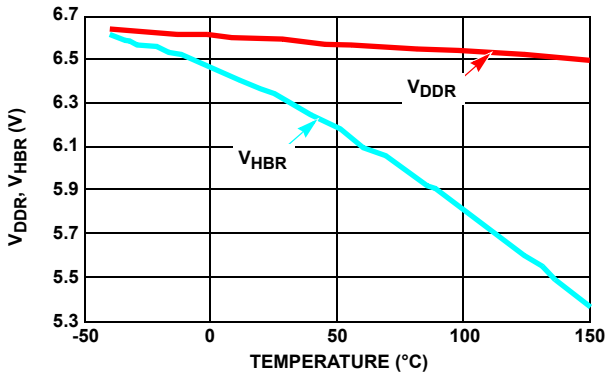

FIGURE 9. UNDERVOLTAGE LOCKOUT THRESHOLD vs TEMPERATURE

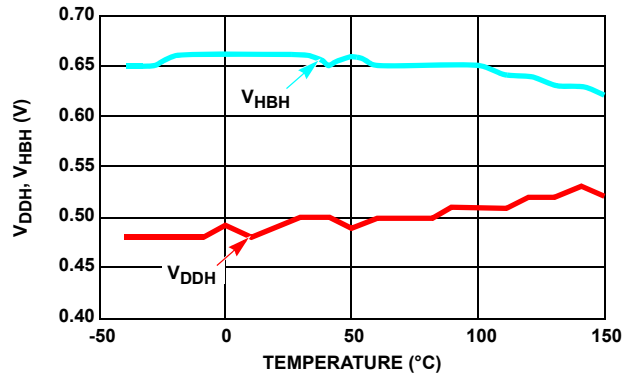

FIGURE 10. UNDERVOLTAGE LOCKOUT HYSTERESIS vs TEMPERATURE

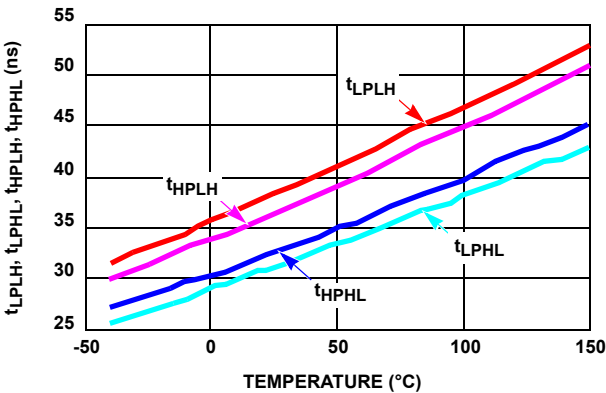

FIGURE 11. HIP2122 PROPAGATION DELAYS vs TEMPERATURE

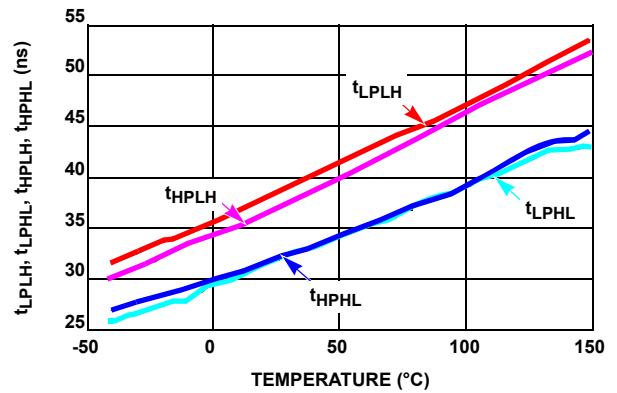

FIGURE 12. HIP2123 PROPAGATION DELAYS vs TEMPERATURE

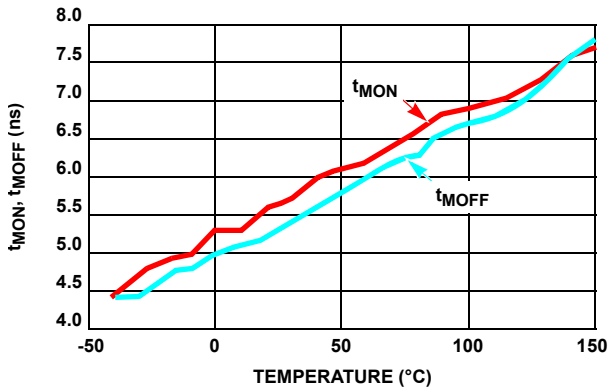

FIGURE 13. HIP2122 DELAY MATCHING vs TEMPERATURE

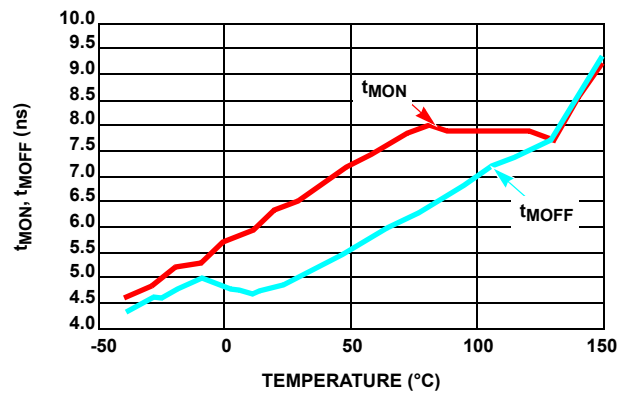

FIGURE 14. HIP2123 DELAY MATCHING vs TEMPERATURE

Typical Performance Curves (Continued)

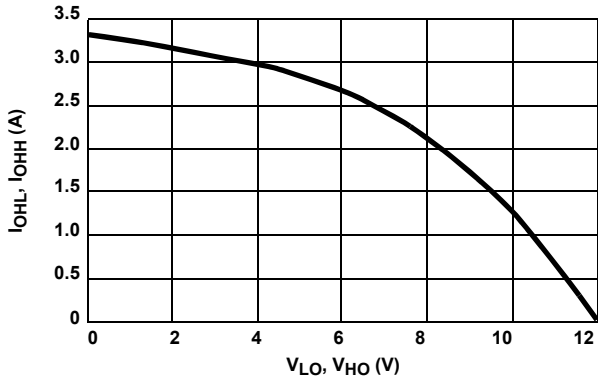

FIGURE 15. PEAK PULL-UP CURRENT vs OUTPUT VOLTAGE

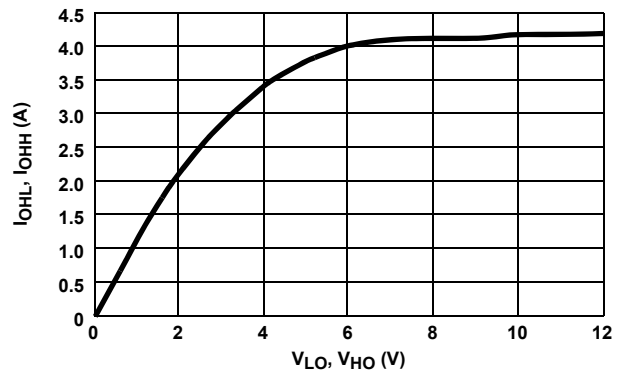

FIGURE 16. PEAK PULL-DOWN CURRENT vs OUTPUT VOLTAGE

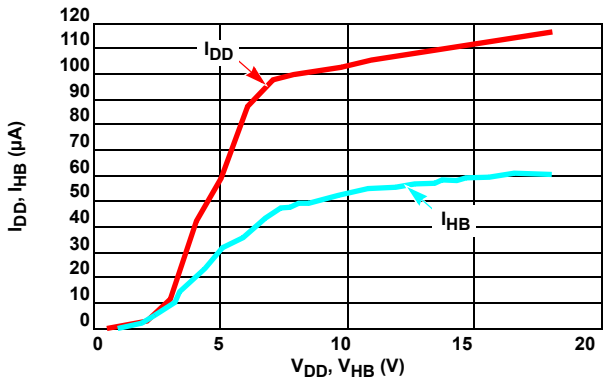

FIGURE 17. HIP2122 QUIESCENT CURRENT vs VOLTAGE

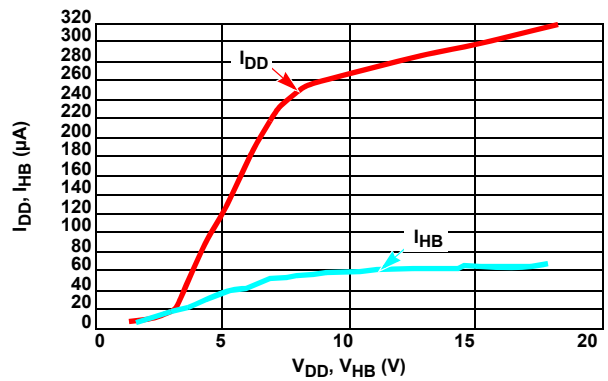

FIGURE 18. HIP2123 QUIESCENT CURRENT vs VOLTAGE

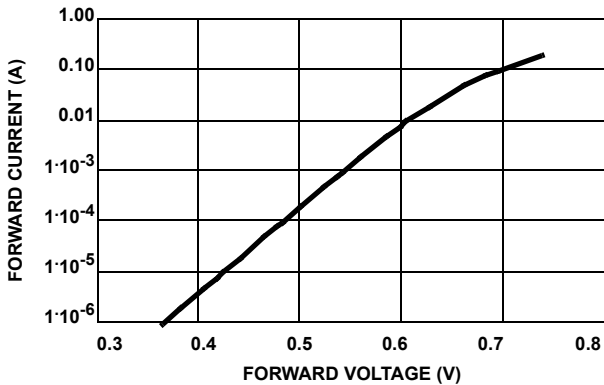

FIGURE 19. BOOTSTRAP DIODE I-V CHARACTERISTICS

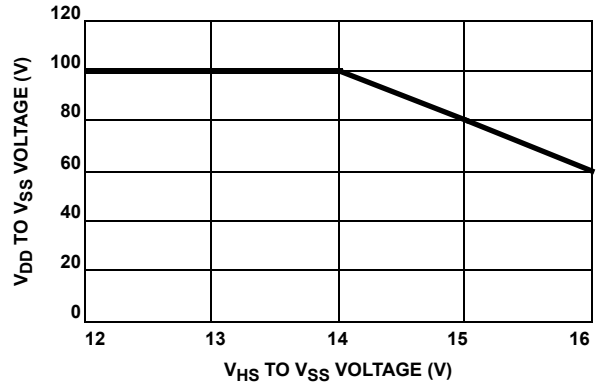

FIGURE 20. V_{HS} VOLTAGE vs V_{DD} VOLTAGE

Functional Description

Functional Overview

The HIP2122/23 have independent control inputs, LI and HI, for each output; LO and HO. When LI is low, LO is low and likewise, when HI is low, HO is low. The output negative transitions occur with minimal (and fixed) propagation delays.

The positive transitions of each output are delayed by the programmed delay as set by RDT. With 80k, the delay is nominally 25ns. With 8k, the delay is nominally 220ns. Resistors values less than 8k and greater than 80k are not recommended. The delay time as a function of R_{DT} is approximately $t_{DT}(ns) = 2/R_{DT}$.

Delaying the rising edge but not the falling edge of each output is the technique that prevents shoot-thru. Please note that there is no logic that prevents both outputs from being on if both inputs are on simultaneously.

The enable pin, EN, when low, drives both outputs to a low state.

When the PWM input transitions, it is necessary to insure that both bridge FETs are not on at the same time to prevent shoot-through currents (break before make). The programmable dead time forces both outputs to be off before either of the bridge FETs is driven on. An 8k Ω resistor connected between R_{DT} and V_{SS} results in a nominal dead time of 250ns. An 80k Ω results with a minimum nominal dead time of 50ns. Resistor values less than 8k and greater than 80k are not recommended. Dead-time as a function of R_{DT} is nominally $t_{DT}(ns) = 2/R_{DT}$.

The high-side driver bias is established by the boot capacitor connected between HB and HS. The charge on the boot capacitor is provided by the internal boot diode that is connected to V_{DD} . The current path to charge the boot capacitor occurs when the low-side bridge FET is on. This charge current is limited in amplitude by the inherent resistance of the boot diode and by the drain-source voltage of the low-side FET. Assuming that the on time of the low-side FET is sufficiently long to fully charge the boot capacitor, the boot voltage will charge very close to V_{DD} (less the boot diode drop and the low-side FET on voltage).

When the HI input transitions high, the high-side bridge FET is driven on after the delay time. Because the HS node is connected to the source of the high-side FET, the HS node will rise almost to the level of the bridge voltage (less the conduction voltage across the bridge FET). Because the boot capacitor voltage is referenced to the source voltage of the high-side FET, the HB node is V_{DD} volts above the HS node and the boot diode is reversed biased. Because the high-side driver circuit is referenced to the HS node, the HO output is now approximately $V_{HB} + V_{BRIDGE}$ above ground.

During the low to high transition of the HS node, the boot capacitor sources the necessary gate charge to fully enhance the high-side bridge FET gate. After the gate is fully charged, the boot capacitor no longer sources the charge to the gate but continues to provide bias current to the high-side driver. It is clear that the charge of the boot capacitor must be substantially larger than the required charge of the high-side FET and high-side driver otherwise the boot voltage will sag excessively. If the boot capacitor value is too small for the required maximum of on-time

of the high-side FET, the high-side UV lockout may engage resulting with an unexpected operation.

Application Information

Selecting the Boot Capacitor Value

The boot capacitor value is chosen not only to supply the internal bias current of the high-side driver but also, and more significantly, to provide the gate charge of the driven FET without causing the boot voltage to sag excessively. In practice, the boot capacitor should have a total charge that is about 20 times the gate charge of the driven power FET for approximately a 5% drop in voltage after the charge has been transferred from the boot capacitor to the gate capacitance.

The following parameters are required to calculate the value of the boot capacitor for a specific amount of voltage droop. In this example, the values used are arbitrary. They should be changed to comply with the actual application.

$V_{DD} = 10V$	V_{DD} can be any value between 7 and 14VDC
$V_{HB} = V_{DD} - 0.6V = V_{HO}$	High side driver bias voltage (V_{DD} - boot diode voltage) referenced to V_{HS}
Period = 1ms	This is the longest expected switching period
$I_{HB} = 100\mu A$	Worst case high side driver current when $xHO = high$ (this value is specified for $V_{DD} = 12V$ but the error is not significant)
$R_{GS} = 100k\Omega$	Gate-source resistor (usually not needed)
Ripple = 5%	Desired ripple voltage on the boot capacitor (larger ripple is not recommended)
$I_{gate_leak} = 100nA$	From the FET vendor's datasheet
$Q_{gate80V} = 64nC$	From Figure 21

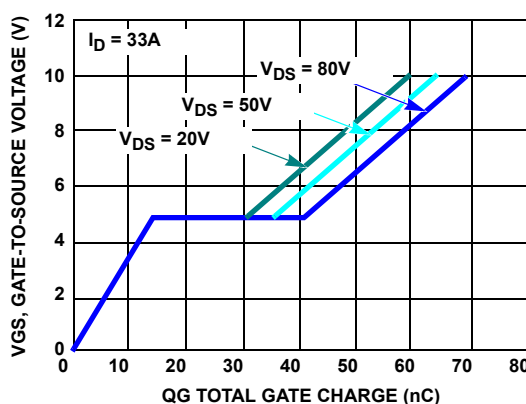

FIGURE 21. TYPICAL GATE CHARGE OF A POWER FET

The following equations calculate the total charge required for the Period. This equation assumes that all of the parameters are constant during the period duration. The error is insignificant if the ripple is small.

HIP2122, HIP2123

$$Q_c = Q_{gate80V} + \text{Period} \times (I_{HB} + V_{HO}/R_{GS} + I_{gate_leak})$$

$$C_{boot} = Q_c / (\text{Ripple} \times VDD)$$

$$C_{boot} = 0.52\mu F$$

If the gate to source resistor is removed (R_{GS} is usually not needed or recommended), then:

$$C_{boot} = 0.33\mu F$$

Typical Application Circuit

Figure 23 is an example of how the HIP2122/23 can be configured for a half bridge power supply application.

Depending on the application, the switching speed of the bridge FETs can be reduced by adding series connected resistors between the xHO outputs and the FET gates. Gate-Source resistors are recommended on the low Side FETs to prevent unexpected turn-on of the bridge should the bridge voltage be applied before VDD. Gate-source resistors on the high side FETs are not usually required if low-side gate-source resistors are used. If relatively small gate-source resistors are used on the high-side FETs, be aware that they will load the boot capacitor, which will then require a larger value for the boot capacitor.

Transients on HS Node

An important operating condition that is frequently overlooked by designers is the negative transient on the xHS pins that occurs when the high side bridge FET turns off. The Absolute Maximum transient allowed on the xHS pin is -6V but it is wise to minimize the amplitude to lower levels. This transient is the result of the parasitic inductance of the low-side drain-source conductor on the PCB. Even the parasitic inductance of the low-side FET contributes to this transient.

When the high-side bridge FET turns off (see Figure 22), because of the inductive characteristics of the load, the current that was flowing in the high-side FET (blue) must rapidly commutate to flow through the low side FET (red). The amplitude of the negative transient impressed on the xHS node is $(di/dt \times L)$ where

L is the total parasitic inductance of the low-side FET drain-source path and di/dt is the rate at which the high-side FET is turned off. With the increasing power levels of power supplies and motor, clamping this transient become more and more significant for the proper operation of the HIP2122/23.

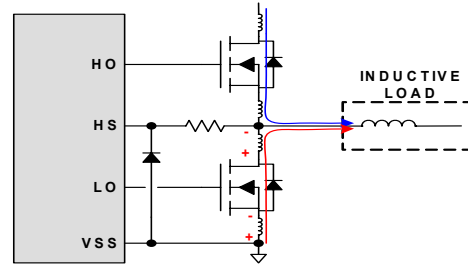

FIGURE 22. PARASITIC INDUCTANCE CAUSES TRANSIENTS ON HS NODE

There are several ways of reducing the amplitude of this transient. If the bridge FETs are turned off more slowly to reduce di/dt , the amplitude will be reduced but at the expense of more switching losses in the FETs. Careful PCB design will also reduce the value of the parasitic inductance. However, these two solutions by themselves may not be sufficient. Figure 22 illustrates a simple method for clamping the negative transient. A fast PN junction, 1A diode is connected between xHS and VSS as shown. It is important that this diode be placed as close as possible to the xHS and VSS pins to minimize the parasitic inductance of this current path. Because this clamping diode is essentially in parallel with the body diode of the low side FET, a small value resistor is necessary to limit current when the body diode of the low side bridge FET is conducting during the dead time.

Please note that a similar transient with a positive polarity occurs when the low-side FET turns off. This is less frequently a problem because xHS node is floating up toward the bridge bias voltage. The Absolute Max voltage rating for the xHS node does need to be observed when the positive transient occurs.

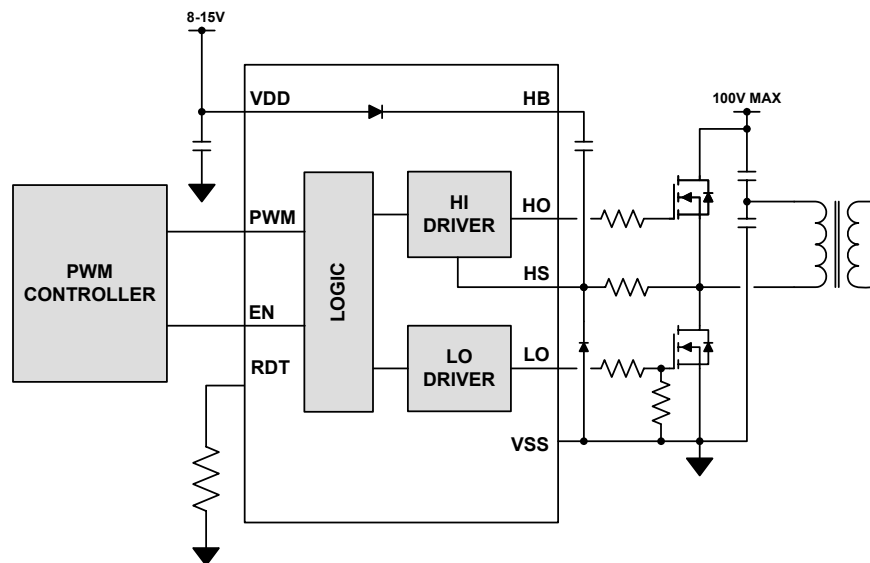

FIGURE 23. TYPICAL HALF BRIDGE APPLICATION

Power Dissipation

The dissipation of the HIP2122/23 is dominated by the gate charge required by the driven bridge FETs and the switching frequency. The internal bias and boot diode also contribute to the total dissipation but these losses are usually insignificant compared to the gate charge losses.

The calculation of the power dissipation of the HIP2122/23 is very simple.

Gate Power (for the HO and LO outputs):

$$P_{\text{gate}} = 4 \times Q_{\text{gate}} \times \text{Freq} \times V_{\text{DD}}$$

where

Q_{gate} is the charge of the driven bridge FET at VDD, and

Freq is the switching frequency.

Boot diode dissipation:

$$I_{\text{diode_avg}} = Q_{\text{gate}} \times \text{Freq}$$

$$P_{\text{diode}} = I_{\text{diode_avg}} \times 0.6V$$

where 0.6V is the diode conduction voltage

Bias current:

$$P_{\text{bias}} = I_{\text{bias}} \times V_{\text{DD}}$$

where I_{bias} is the internal bias current of the HIP2122/23 at the switching frequency

Total Power Dissipation:

$$P_{\text{total}} = P_{\text{gate}} + P_{\text{diode}} + P_{\text{bias}}$$

Operating Temperatures:

$$T_j = P_{\text{total}} \times \theta_{\text{JA}} + T_{\text{amb}}$$

where T_j is the junction temperature at the operating air temperature, T_{amb} , in the vicinity of the part.

$$T_j = P_{\text{total}} \times \theta_{\text{JC}} + T_{\text{PCB}}$$

where T_j is the junction temperature with the operating temperature of the PCB, T_{PCB} , measured where the EPAD is soldered.

PC Board Layout

The AC performance of the HIP2122/23 depends significantly on the design of the PC board. The following layout design guidelines are recommended to achieve optimum performance from the HIP2122/23:

- Understand well how power currents flow. The high amplitude di/dt currents of the bridge FETs will induce significant voltage transients on the associated traces.
- Keep power loops as short as possible by paralleling the source and return traces.
- Use planes where practical; they're usually more effective than parallel traces.
- Planes can also be non-grounded nodes.
- Avoid paralleling high di/dt traces with low level signal lines. High di/dt will induce currents in the low level signal lines.

- When practical, minimize impedances in low level signal circuits; the noise, magnetically induced on a 10k resistor, is 10x larger than the noise on a 1k resistor.
- Be aware of magnetic fields emanating from transformers and inductors. Core gaps in these structures are especially bad for emitting flux.
- If you must have traces close to magnetic devices, align the traces so that they are parallel to the flux lines.
- The use of low inductance components, such as chip resistors and chip capacitors is recommended.
- Use decoupling capacitors to reduce the influence of parasitic inductors. To be effective, these capacitors must also have the shortest possible lead lengths. If vias are used, connect several paralleled vias to reduce the inductance of the vias.
- It may be necessary to add resistance to dampen resonating parasitic circuits. The most likely circuit will be the HO and LO outputs. In PCB designs with long leads on the LI and HI inputs, it may also be necessary to add series resistors with the LI and HI inputs.
- Keep high dv/dt nodes away from low level circuits. Guard banding can be used to shunt away dv/dt injected currents from sensitive circuits. This is especially true for the PWM control circuits.
- Avoid having a signal ground plane under a high dv/dt circuit. This will inject high di/dt currents into the signal ground paths.
- Do power dissipation and voltage drop calculations of the power traces. Most PCB/CAD programs have built in tools for calculation of trace resistance.
- Large power components (Power FETs, Electrolytic capacitors, power resistors, etc.) will have internal parasitic inductance, which cannot be eliminated. This must be accounted for in the PCB layout and circuit design.
- If you simulate your circuits, consider including parasitic components.

EPAD Design Considerations

The thermal pad of the HIP2122/23 is electrically isolated. It's primary function is to provide heat sinking for the IC. It is recommended to tie the EPAD to $V_{\text{SS}}(\text{GND})$.

The following is an example of how to use vias to remove heat from the IC substrate.

HIP2122, HIP2123

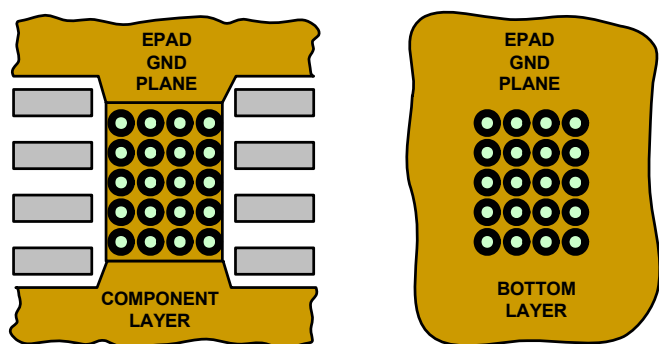

FIGURE 24. TYPICAL PCB PATTERN FOR THERMAL VIAS

Depending on the amount of power dissipated by the HIP2122/23, it may be necessary, to connect the EPAD to one or more ground plane layers. A via array, within the area of the EPAD, will conduct heat from the EPAD to the GND plane on the bottom layer. If inner PCB layers are available, it is also desirable to connect these additional layers with the plated-through vias.

The number of vias and the size of the GND planes required for adequate heatsinking is determined by the power dissipated by the HIP2122/23, the air flow, and the maximum temperature of the air around the IC.

It is important that the vias have a low thermal resistance for efficient heat transfer. Do not use “thermal relief” patterns to connect the vias.

Revision History

The revision history provided is for informational purposes only and is believed to be accurate, but not warranted. Please go to web to make sure you have the latest revision.

DATE	REVISION	CHANGE
December 23, 2011	FN7670.0	Initial Release

Products

Intersil Corporation is a leader in the design and manufacture of high-performance analog semiconductors. The Company's products address some of the industry's fastest growing markets, such as, flat panel displays, cell phones, handheld products, and notebooks. Intersil's product families address power management and analog signal processing functions. Go to www.intersil.com/products for a complete list of Intersil product families.

For a complete listing of Applications, Related Documentation and Related Parts, please see the respective device information page on intersil.com: [HIP2122, HIP2123](http://intersil.com/HIP2122_HIP2123)

To report errors or suggestions for this datasheet, please go to: www.intersil.com/askourstaff

FITs are available from our website at: <http://rel.intersil.com/reports/sear>

For additional products, see www.intersil.com/product_tree

Intersil products are manufactured, assembled and tested utilizing ISO9000 quality systems as noted in the quality certifications found at www.intersil.com/design/quality

Intersil products are sold by description only. Intersil Corporation reserves the right to make changes in circuit design, software and/or specifications at any time without notice. Accordingly, the reader is cautioned to verify that data sheets are current before placing orders. Information furnished by Intersil is believed to be accurate and reliable. However, no responsibility is assumed by Intersil or its subsidiaries for its use; nor for any infringements of patents or other rights of third parties which may result from its use. No license is granted by implication or otherwise under any patent or patent rights of Intersil or its subsidiaries.

For information regarding Intersil Corporation and its products, see www.intersil.com

HIP2122, HIP2123

Package Outline Drawing

L9.4x4

9 LEAD THIN DUAL FLAT NO-LEAD PLASTIC PACKAGE

Rev 1, 1/10

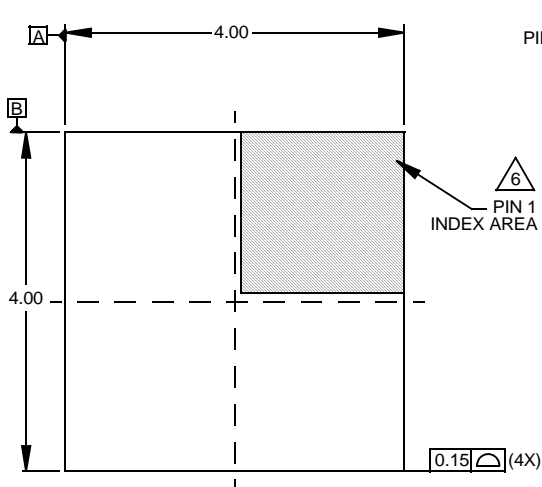

TOP VIEW

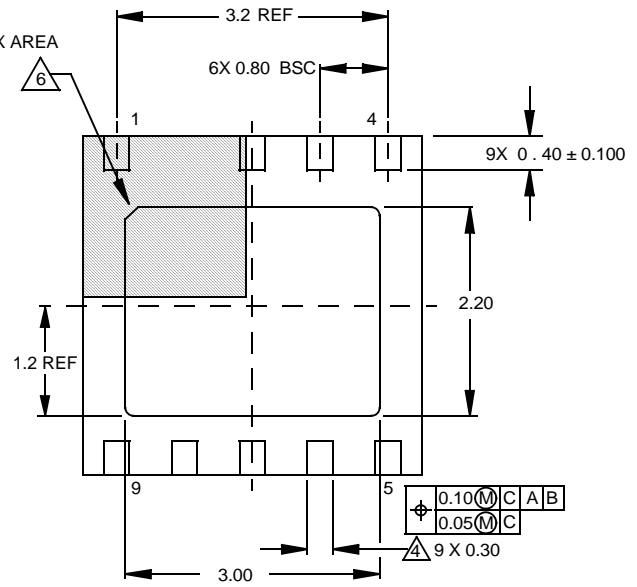

BOTTOM VIEW

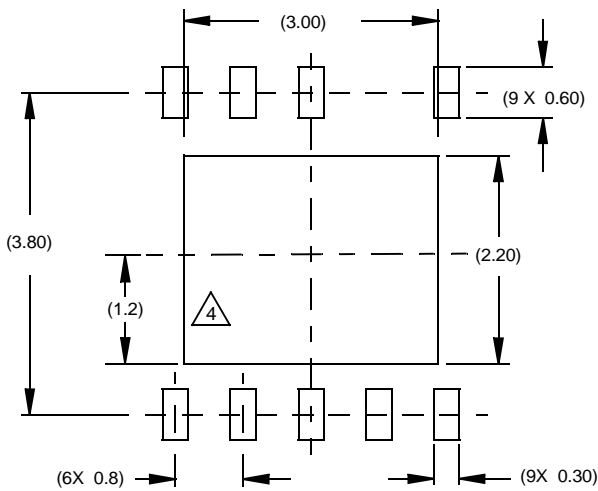

TYPICAL RECOMMENDED LAND PATTERN

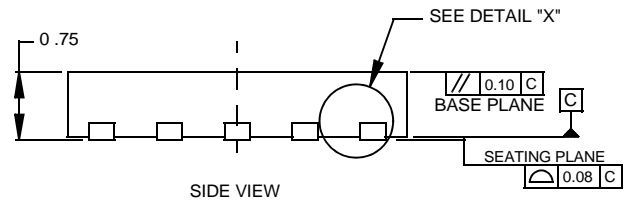

SIDE VIEW

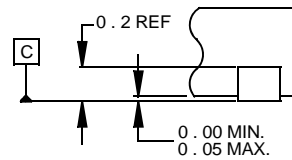

DETAIL "X"

NOTES:

1. Dimensions are in millimeters.
Dimensions in () for Reference Only.
2. Dimensioning and tolerancing conform to AMSE Y14.5m-1994.
3. Unless otherwise specified, tolerance : Decimal ± 0.05
4. E-Pad is offset from center.
5. Tiebar (if present) is a non-functional feature.
6. The configuration of the pin #1 identifier is optional, but must be located within the zone indicated. The pin #1 identifier may be either a mold or mark feature.

HIP2122, HIP2123

Package Outline Drawing

L10.4x4

10 LEAD THIN DUAL FLAT NO-LEAD PLASTIC PACKAGE

Rev 1, 1/08

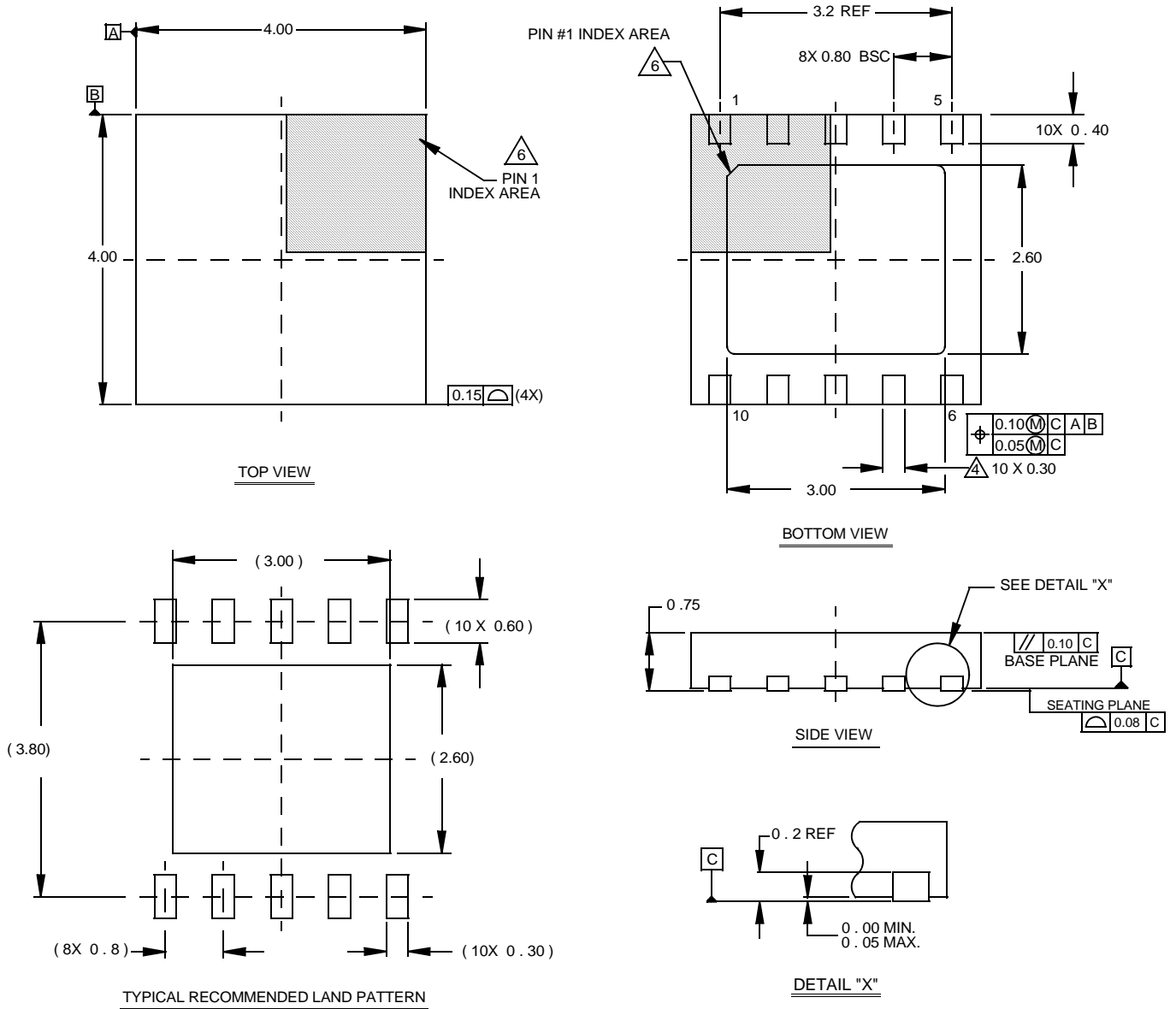

NOTES:

1. Dimensions are in millimeters.
Dimensions in () for Reference Only.
2. Dimensioning and tolerancing conform to AMSE Y14.5m-1994.
3. Unless otherwise specified, tolerance : Decimal ± 0.05
4. Dimension b applies to the metallized terminal and is measured between 0.15mm and 0.30mm from the terminal tip.
5. Tiebar shown (if present) is a non-functional feature.
6. The configuration of the pin #1 identifier is optional, but must be located within the zone indicated. The pin #1 identifier may be either a mold or mark feature.