

410-3086 Component Clip, .085 (2,16) Slot, Swage mount

Recommended mounting hole .120 (3,05)

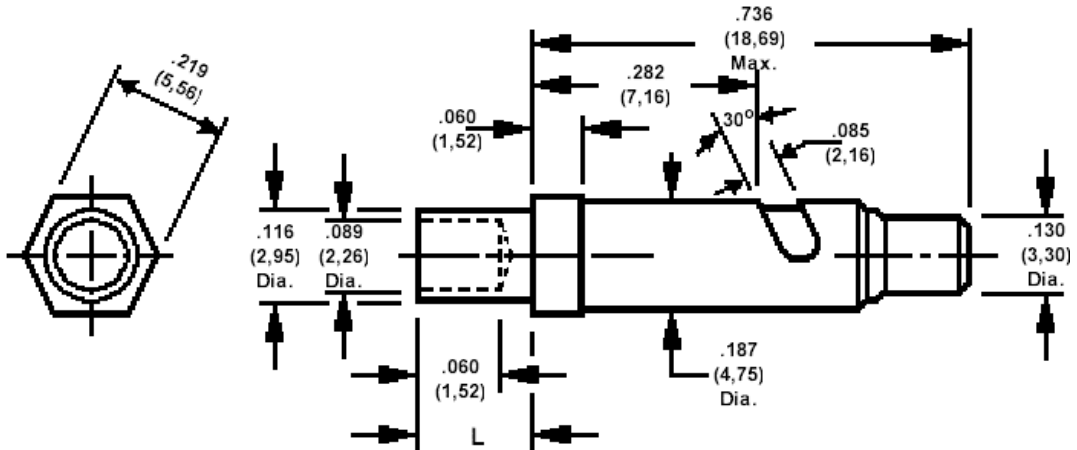

Recommended Lead Wire Sizes - #19 AWG (.036) (0,91) Min. Thru #13 AWG (.072) (1,83) Max.

How to order code

410-3086-XX-05-00

Basic Part No (XX - Board Thickness)

Basic Part No	XX	L	Board Thickness
410-3086	-01	.062 (1,57)	.031 (0,79)
	-02	.094 (2,39)	.062 (1,59)
	-03	.125 (3,18)	.094 (2,38)
	-04	.156 (3,96)	.125 (3,18)

Component	Material	Finish
Housing	Brass	Electro Solder
Plunger	Brass	Electro Solder
Spring	Cres. Steel	Passivated

TOOLING	
Anvil	435-6441-01-00-00
Roll punch	435-6663-01-00-00