

Sound Processors for BOOM BOX / Mini-component Stereo



# Single Power Supply Sound Processors with Built-in Pre Amplifier for Tape Recording and Play Back (With Integrated 2-/3- band Equalizer)

BD3401KS2, BD3402KS2

No.10086EAT03

## ●Description

The Sound Processor with built-in record/play functions for cassette players, is suited for sound quality products such as, BOOM BOX, mini- and micro-audio systems. It incorporates various functions ranging from audio source selectors to preamplifiers at the front stage, preamplifier for cassette recording/playing, and a 2-wire serial bus.

## ●Features

- 1) Provides Surround and Bass Boost with the Soft-switching feature to reduce the shock sound at switching (BD3401KS2)
  - 2) Provides a specialized power supply terminal in a digital circuit, in order to set and maintain the state inside the IC by the minute stand-by current.
  - 3) Built-in preamplifier for cassette recording/playing allows for minimal external components, freeing up board space.
  - 4) Arranges all I/O terminals to a single point and allows easy PCB routing.
  - 5) Volume and Tone implemented with a resistance ladder circuit; achieving high performance with low noise and low distortion
  - 6) Energy-saving design resulting in low current consumption, by utilizing the BiCMOS process.
- It has the advantage in quality over the scaling down the power heat control of the internal regulators.

## ●Applications

BOOM BOX, mini-audio systems, and micro-audio systems.

## ●Product lineup

Parameter	BD3401KS2	BD3402KS2
Equalizer	3 band(BASS, MIDDLE, TREBLE)	2 band(BASS, TREBLE)
Volume	0 to -44dB/2dB step -44 to -76dB/4dB step, -∞dB	0 to -44dB/2dB step -44 to -76dB/4dB step, -∞dB
Cassette Recording/Playing Amplifier	○	○
Karaoke	○	-
Microphone Input	○	-
Subwoofer Output	○	-
Output for Spectrum Analyzer	○	-
Surround	○	-
Bass Boost	○	-
Package	SQFP-T64	SQFP-T64

## ●Absolute maximum ratings (Ta=25°C)

Items	Symbol	Ratings	Unit
Power Supply Voltage	Vcc	10	V
	Vdd	6	V
Power Dissipation	Pd	1200*	mW
Input Voltage Range	Vin	GND-0.3 to VCC+0.3	V
Operating Temperature Range	Topr	-25 to +75	°C
Storage Temperature Range	Tstg	-55 to +125	°C

\* Reduced by 12 mW/°C over 25°C, when installed on the standard board (size: 70 × 70 × 1.6mm).

## ●Operating voltage range

Device Name	Symbol	Range	Unit
BD3401KS2	Vcc	8 to 9.5	V
BD3402KS2	Vdd	3 to 5.5	

## ● Electrical characteristics

◎ BD3401KS2

Ta=25°C, VCC=9V, VDD=5V, f=1kHz, Vi=1Vrms, RL=10kΩ, Rg=600Ω, INPUT SELECTOR=Ach, INPUT GAIN=0dB, VOLUME=0dB, TREBLE=0dB, BASS=0dB, MIDDLE=0dB, TONE ATT=0dB, MUX=STEREO, MIXING=OFF, MIXING GAIN=0dB, PLAY BACK=TAPE A, REC=OFF, LINE=OFF, MIC=OFF, BASS BOOST=OFF, SURROUND=OFF, AMS=OFF, ALC=OFF, INPUT=pin59,60, OUTPUT=pin32,33, unless otherwise noted.

	Parameter	Symbol	Limits			Unit	Conditions
			Min.	Typ.	Max.		
TOTAL	Circuit Current	IQ	-	35	50	mA	(No signal)
	Output Voltage Gain	Gv	-2	0	2	dB	INPUT GAIN=0dB
	Total Harmonic Distortion ratio	THDt	-	0.005	0.05	%	BW=400 to 30kHz OUT=pin32,33,53,54
	Maximum Output Voltage	Vomaxt	2.0	2.5	-	Vrms	THD=1%, BW=400 to 30kHz OUT=pin32,33,53,54
	Residual Noise Voltage*	Vr	-	1.8	6.0	μVrms	Rg=0Ω, Vol=-∞dB, BW=IHF-A,
	Output Noise Voltage*	Vno	-	3.0	9.0	μVrms	Rg=0Ω, Vol=0dB BW=IHF-A
	Cross-talk between Channels*	CTC	-	-80	-70	dB	Rg=0Ω, BW=IHF-A VOLOUT=1Vrms
	Cross-talk between Selectors*	CTS	-	-80	-70	dB	Rg=0Ω, BW=IHF-A
	Input Impedance	Rin	32	47	62	kΩ	Pin1 to 4, 59 to 64
MIXING	Total Harmonic Distortion ratio	THDmix	-	0.01	0.1	%	BW=400 to 30kHz, MIXING=ON INPUT SELECTOR=B
	Maximum Output Voltage	Vomaxmix	2.0	2.5	-	Vrms	THD=1%, BW=400 to 30kHz MIXING=ON INPUT SELECTOR=B
PLAYBACK	Output Voltage Gain	Gvp	23	25	27	dB	Vi=20mVrms, pin5-6, 7-8=short IN=pin9,10 OUT=pin6,7
	Total Harmonic Distortion ratio	THDp	-	0.01	0.1	%	Vi=20mVrms BW=400 to 30kHz pin5-6, 7-8=short IN=pin9,10 OUT=pin6,7
	Maximum Output Voltage	Vomaxp	2.0	2.5	-	Vrms	THD=1%, BW=400 to 30kHz pin5-6, 7-8=short IN=pin9,10 OUT=pin6,7
	Noise Voltage in input term*	Vnin	-	0.7	6.0	μVrms	Rg=0Ω, BW=IHF-A pin5-6, 7-8=short IN=pin9,10 OUT=pin6,7
	PB MUTE Amount	PBM	-	-	-70	dB	BW=IHF-A, pin5-6, 7-8=short IN=pin9,10 PLAY BACK=MUTE
REC	ALC Operation Level	ALC	0.5	0.7	0.9	Vrms	REC=ON ALC=ON
	Total Harmonic Distortion ratio	THDr	-	0.2	1	%	BW=400 to 30kHz OUT=pin14,15 REC=ON ALC=ON
	Output Noise Voltage*	Vnor	-	40	120	μVrms	Rg=0Ω, BW=IHF-A OUT=pin14,15 REC=ON ALC=ON

	Parameter	Symbol	Limits			Unit	Conditions
			Min	Typ.	Max		
MIC	Total Harmonic Distortion ratio	THDmic	-	0.01	0.1	%	BW=400 to 30kHz MIC=ON
	Maximum Output Voltage	V <sub>omaxmic</sub>	2.0	2.5	-	V <sub>rms</sub>	THD=1%, BW=400 to 30kHz MIC=ON
SPECTRUM ANALYZER	Spectrum Analyzer 1 Output Voltage Gain	G <sub>vs1</sub>	-8	-6	-4	dB	OUTPUT=pin55
	Spectrum Analyzer 2 Output Voltage Gain	G <sub>vs2</sub>	-2	0	2	dB	OUTPUT=pin56
SURROUND	Surround Gain	G <sub>sur</sub>	4	6	8	dB	SURROUND=ON Vi=500mV <sub>rms</sub>
TREBLE	Treble Gain	G <sub>t</sub>	-8 to +8(2dB/step)			dB	Vi=500mV <sub>rms</sub>
	Treble Gain Setting Error	TE	-2	0	2	dB	
MIDDLE	Middle Gain	G <sub>m</sub>	-8 to +8(2dB/step)			dB	Vi=500mV <sub>rms</sub>
	Middle Gain Setting Error	ME	-2	0	-2	dB	
BASS	Bass Gain	G <sub>b</sub>	-8 to +8(2dB/step)			dB	Vi=500mV <sub>rms</sub>
	Bass Gain Setting Error	BE	-2	0	-2	dB	
AMS	AMS EQ Gain	G <sub>ams</sub>	33	35	37	dB	OUTPUT=pin40 AMS=ON, Vi=20mV <sub>rms</sub>
VOLUME	Volume Setting Error 1	VE1	-2	0	2	dB	0 to -48dB, BW=IHF-A VOLOUT=1V <sub>rms</sub>
	Volume Setting Error 2	VE2	-3	0	3	dB	-52 to -76dB, BW=IHF-A VOLOUT=1V <sub>rms</sub>
	Maximum Attenuation*	V <sub>min</sub>	-	-	-90	dB	BW=IHF-A VOLOUT=1V <sub>rms</sub>
SUBWOOFER	Total Harmonic Distortion ratio	THDs	-	0.01	0.1	%	Vi=500mV <sub>rms</sub> BW=400 to 30kHz, OUT=pin25 No LPF
	Maximum Output Voltage	V <sub>omaxs</sub>	1.5	2.0	2.5	V <sub>rms</sub>	THD=3%, BW=400 to 30kHz OUT=pin25, No LPF

©BD3402KS2

Ta=25°C, VCC=9V, VDD=5V, f=1kHz, Vi=1Vrms, RL=10kΩ, Rg=600Ω, INPUT SELECTOR=Ach, INPUT GAIN=0dB, VOLUME=0dB, TREBLE=0dB, BASS=0dB, TONE ATT=0dB, MUX=STEREO, MIXING=OFF, MIXING GAIN=0dB, REC=OFF, LINE=OFF, ALC=OFF INPUT=pin59,60, OUTPUT=pin32,33, unless otherwise noted.

	Parameter	Symbol	Limits			Unit	Conditions
			Min.	Typ.	Max.		
TOTAL	Circuit Current	IQ	-	28	50	mA	(No signal)
	Output Voltage Gain	Gv	-2	0	2	dB	INPUT GAIN=0dB
	Total Harmonic Distortion ratio	THDt	-	0.005	0.05	%	BW=400 to 30kHz OUT=pin32,33,53,54
	Maximum Output Voltage	Vomaxt	2.0	2.5	-	Vrms	THD=1%, BW=400 to 30kHz OUT=pin32,33,53,54
	Residual Noise Voltage*	Vr	-	1.5	5.0	μVrms	Rg=0Ω, Vol=-∞dB BW=IHF-A,
	Output Noise Voltage*	Vno	-	2.5	8.0	μVrms	Rg=0Ω, Vol=0dB BW=IHF-A
	Cross-talk between Channels*	CTC	-	-80	-70	dB	Rg=0Ω, BW=IHF-A VOLOUT=1Vrms
	Cross-talk between Selectors*	CTS	-	-80	-70	dB	Rg=0Ω, BW=IHF-A
	Input Impedance	Rin	32	47	62	kΩ	Pin1 to 4, 59 to 64
MIXING	Total Harmonic Distortion ratio	THDmix	-	0.01	0.1	%	BW=400 to 30kHz MIXING=ON INPUT SELECTOR=B
	Maximum Output Voltage	Vomaxmix	2.0	2.5	-	Vrms	THD=1%, BW=400 to 30kHz MIXING=ON INPUT SELECTOR=B
PLAYBACK	Output Voltage Gain	Gvp	23	25	27	dB	Vi=20mVrms pin5-6, 7-8=short IN=pin11,12 OUT=pin6,7
	Total Harmonic Distortion ratio	THDp	-	0.01	0.1	%	Vi=20mVrms BW=400 to 30kHz pin5-6, 7-8=short IN=pin11,12 OUT=pin6,7
	Maximum Output Voltage	Vomaxp	2.0	2.5	-	Vrms	THD=1%, BW=400 to 30kHz pin5-6, 7-8=short IN=pin11,12 OUT=pin6,7
	Noise Voltage in input term*	Vnin	-	0.7	6.0	μVrms	Rg=0Ω, BW=IHF-A pin5-6, 7-8=short IN=pin11,12 OUT=pin6,7
	PB MUTE Amount	PBM	-	-	-70	dB	BW=IHF-A, pin5-6, 7-8=short IN=pin11,12 PLAY BACK=MUTE
REC	ALC Operation Level	ALC	0.5	0.7	0.9	Vrms	REC=ON ALC=ON
	Total Harmonic Distortion ratio	THDr	-	0.2	1	%	BW=400 to 30kHz OUT=pin14,15 REC=ON, ALC=ON
	Output Noise Voltage*	Vnor	-	40	120	μVrms	Rg=0Ω, BW=IHF-A OUT=pin14,15 REC=ON, ALC=ON
TREBLE	Treble Gain	Gt	-8 to +8(2dB/step)			dB	Vi=500mVrms
	Treble Gain Setting Error	TE	-2	0	2	dB	
BASS	Bass Gain	Gb	-12 to +12(3dB/step)			dB	Vi=500mVrms
	Bass Gain Setting Error	BE	-2	0	-2	dB	
VOLUME	Volume Setting Error 1	VE1	-2	0	2	dB	0 to -48dB, BW=IHF-A VOLOUT=1Vrms
	Volume Setting Error 2	VE2	-3	0	3	dB	-52 to -76dB, BW=IHF-A VOLOUT=1Vrms
	Maximum Attenuation*	Vmin	-	-	-90	dB	BW=IHF-A VOLOUT=1Vrms

- \* For measurements marked with \*, VP-9690A (Average value wave detection, Effective value display) filter by Matsushita Communication Industrial is used.
- \* Phase relation between Input/Output signal terminals is the same (Inputs: pin59-64, pin1-4, Outputs: pin32, 33).
- \* This IC is not designed to be radiation-resistant.

●Control signal specifications

1. Signal Timing Conditions

- Data is read on the rising edge of the clock.
- Latch is read on the falling edge of the clock.
- Latch signal must terminate with the LOW state.
- To avoid malfunctions, clock and data signals must terminate with the LOW state.

1byte=8bit

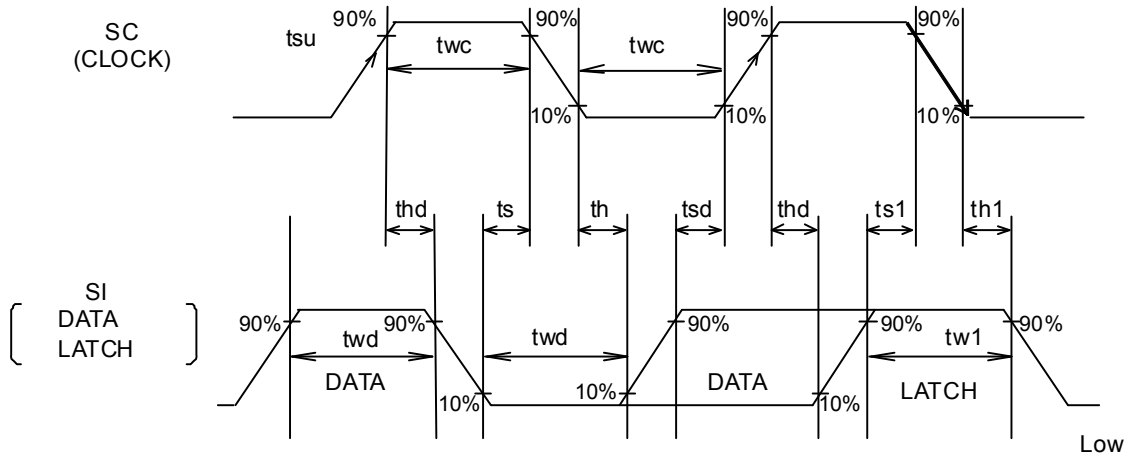

Fig.1

Parameter	Symbol	Limits			Unit
		Min	Typ.	Max	
Minimum Clock Width	twc	2.0	-	-	μS
Minimum Data Width	twd	2.0	-	-	μS
Minimum Latch Width	tw1	2.0	-	-	μS
Data Set-up Time (DATA→CLK)	tsd	1.0	-	-	μS
Data Hold Time (CLK→DATA)	thd	1.0	-	-	μS
Latch Set-up Time (CLK→LATCH)	ts1	1.0	-	-	μS
Latch Hold Time (DATA→LATCH)	th1	1.0	-	-	μS
Latch Low Set-up Time	ts	1.0	-	-	μS
Latch Low Hold Time	th	1.0	-	-	μS

2. Voltage Conditions for Control Signals

Parameter	Symbol	Limits			Unit
		Min	Typ.	Max	
“H” Input Voltage	Vcc=8 to 9.5V	2.2	-	5.5	V
“L” Input Voltage	Vcc=8 to 9.5V	0	-	1.0	V

●Control data format list

(BD3401KS2)

- Basic Configuration of Control Data Format

←Data input direction

	MSB							LSB
	D7	D6	D5	D4	D3	D2	D1	D0
Data	Data					Select Address		

- Control Data Formats

←Data input direction

	D7	D6	D5	D4	D3	D2	D1	D0
Data(1)	Input Selector			Input Gain		0	0	0
	D7	D6	D5	D4	D3	D2	D1	D0
Data(2)	Volume					0	0	1
	D7	D6	D5	D4	D3	D2	D1	D0
Data(3)	Treble				TONE ATT(1)	0	1	0
	D7	D6	D5	D4	D3	D2	D1	D0
Data(4)	Bass				TONE ATT(2)	0	1	1
	D7	D6	D5	D4	D3	D2	D1	D0
Data(5)	Middle				0	1	0	0
	D7	D6	D5	D4	D3			
Data(6)	Subwoofer Gain				1	1	0	0
	D7	D6	D5	D4	D3	D2	D1	D0
Data(7)	MUX		MIXING	MIXING GAIN		1	0	1
	D7	D6	D5	D4	D3	D2	D1	D0
Data(8)	PLAY BACK		REC	LINE	MIC	1	1	0
	D7	D6	D5	D4	D3	D2	D1	D0
Data(9)	Bass Boost	Surround	AMS	ALC	Vocal Fader	1	1	1

(BD3402KS2)

• Basic Configuration of Control Data Format

← Data input direction

	MSB							LSB
Data	D7	D6	D5	D4	D3	D2	D1	D0
	Data					Select Address		

• Control Data Formats

← Data input direction

Data(1)	D7	D6	D5	D4	D3	D2	D1	D0
	Input Selector			Input Gain		0	0	0
Data(2)	D7	D6	D5	D4	D3	D2	D1	D0
	Volume					0	0	1
Data(3)	D7	D6	D5	D4	D3	D2	D1	D0
	Treble				TONE ATT(1)	0	1	0
Data(4)	D7	D6	D5	D4	D3	D2	D1	D0
	Bass				TONE ATT(2)	0	1	1
Data(5)	D7	D6	D5	D4	D3	D2	D1	D0
	MUX		MIXING	MIXING GAIN		1	0	1
Data(6)	D7	D6	D5	D4	D3	D2	D1	D0
	*		REC	LINE	ALC	1	1	0

\* \* Indicates 0 or 1.

- By changing the setting of Select Address, nine different control formats are selectable.
- In every power-on sequence, all of the address data must be initialized.

Example:

← Data input direction

MSB	LSB	MSB	LSB	MSB	LSB	MSB	LSB	MSB	LSB	
Data(1)	L	Data(2)	L	Data(3)	L	Data(4)	L	...	Data(9)	L

"L" means a "latch."

- After power-on, for the second and subsequent times, only the necessary data can be selected for setting.

Example: When changing the volume,

← Data input direction

MSB	LSB
Data(2)	L

"L" means a "latch."

• TONE ATT settings

TONE ATT can be set to either one of three modes: 0dB, -4dB and -8dB using D3 in Data (3) or Data (4).

When setting TONE ATT, data should be sent as follows:

(1) TONE ATT=-4dB

(a) Sending Data (3) only

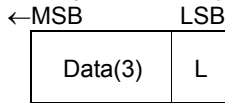

(b) Sending all the data

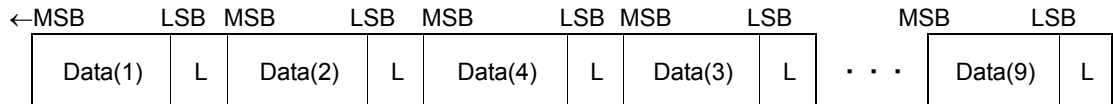

Sending Data(3) after Data(4) follows that Data(3) is given a higher priority.

(2) TONE ATT=-8dB

(a) Sending Data(4) only

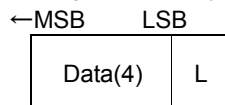

(b) Sending all the data

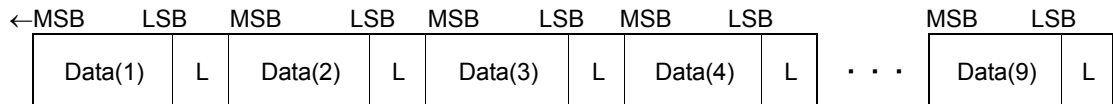

Sending Data(4) after Data(3) follows that Data(4) is given a higher priority.



## ●Pin description

(BD3401KS2)

Pin No.	Pin Name	Description	Pin No.	Pin Name	Description
1	D1	1ch input pin D	33	VOLOUT1	1ch output pin
2	D2	2ch input pin D	34	BBNF1	1ch bass boost filter setting pin
3	E1	1ch input pin E	35	BBIN1	1ch bass boost filter setting pin
4	E2	2ch input pin E	36	VIN1	1ch volume input pin
5	PBNF2	2ch PB filter setting pin	37	TONE OUT1	1ch tone output pin
6	PBOUT2	2ch PB output pin	38	VIN2	2ch volume input pin
7	PBOUT1	1ch PB output pin	39	TONE OUT2	2ch tone output pin
8	PBNF1	1ch PB filter setting pin	40	AMS OUT	AMS output pin
9	TAPE A1	1ch TAPE input pin A	41	BNF2	2ch bass filter setting pin
10	TAPE A2	2ch TAPE input pin A	42	BOUT2	2ch bass filter setting pin
11	TAPE B1	1ch TAPE input pin B	43	BOUT1	1ch bass filter setting pin
12	TAPE B2	2ch TAPE input pin B	44	BNF1	1ch bass filter setting pin
13	RECNF2	2ch REC filter setting pin	45	MNF1	1ch middle filter setting pin
14	RECOUT2	2ch REC output pin	46	MOUT1	1ch middle filter setting pin
15	RECOUT1	1ch REC output pin	47	MOUT2	2ch middle filter setting pin
16	RECNF1	1ch REC filter setting pin	48	MNF2	2ch middle filter setting pin
17	ALC	ALC time constant setting pin	49	TNF2	2ch treble filter setting pin
18	SC	Serial clock input pin	50	TNF1	1ch treble filter setting pin
19	SI	Serial data input pin	51	SUR1	Surround setting pin
20	VDD	Digital power supply pin	52	SUR2	Surround setting pin
21	GND	Ground pin	53	LINEOUT2	2chLINE output pin
22	VCC	Analog power supply pin	54	LINEOUT1	1chLINE output pin
23	1/2VCC	1/2VCC output pin	55	SAOUT2	Spectrum Analyzer output pin 2
24	FILTER	1/2 VCC pin	56	SAOUT1	Spectrum Analyzer output pin 1
25	SW OUT	Subwoofer output pin	57	CAP	Time constant setting pin for absorbing switching shock sound
26	LF4	Primary LPF setting pin	58	MIC	MIC input pin A
27	LF3	Secondary LPF setting pin	59	A1	1ch input pin A
28	LF2	Secondary LPF setting pin	60	A2	2ch input pin A
29	LF1	Secondary LPF setting pin	61	B1	1ch input pin B
30	BBIN2	2ch bass boost filter setting pin	62	B2	2ch input pin B
31	BBNF2	2ch bass boost filter setting pin	63	C1	1ch input pin C
32	VOL OUT2	2ch output pin	64	C2	2ch input pin C

●Block diagram, application circuit, pin assignment

(BD3401KS2)

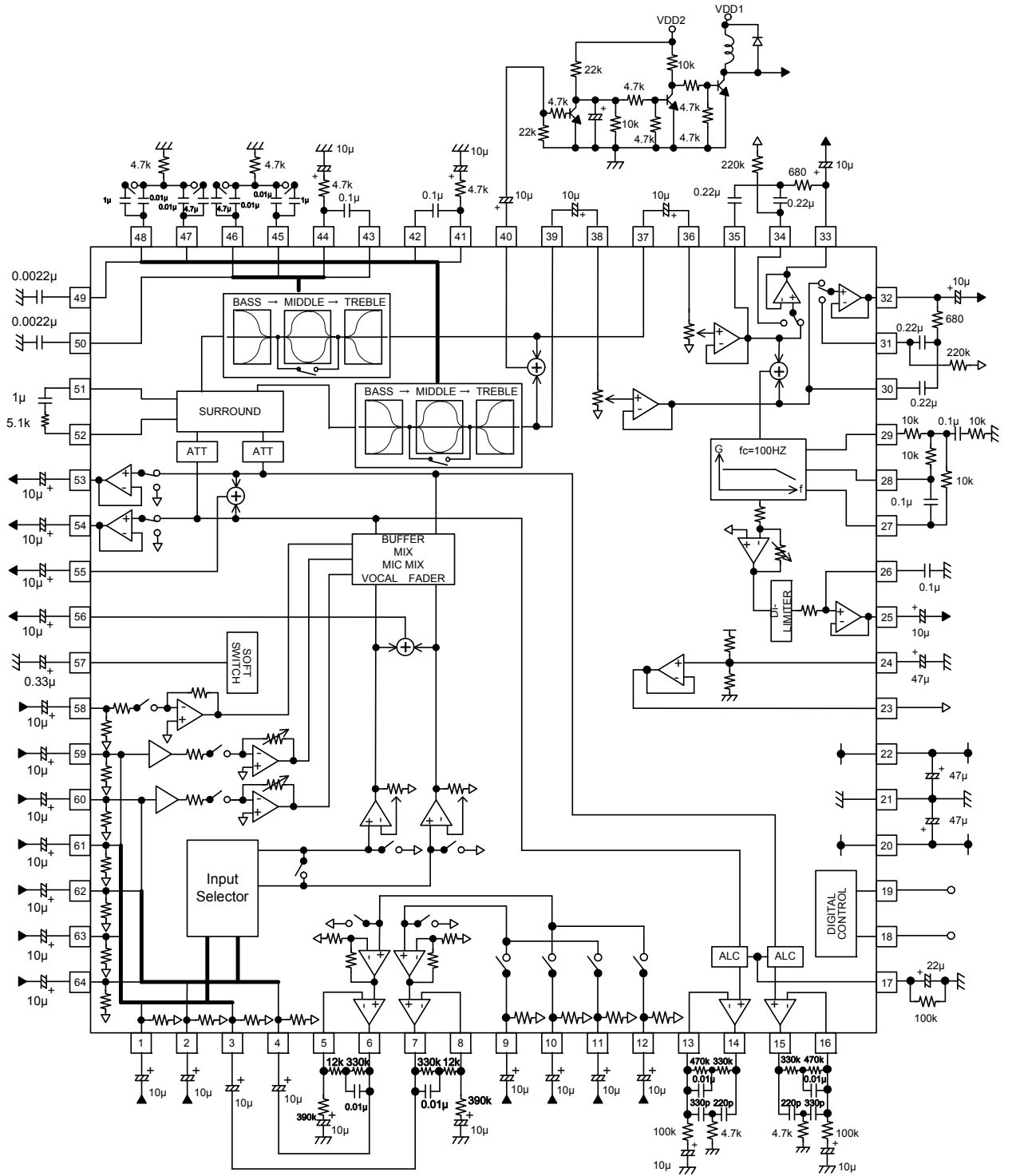

UNIT  
RESISTANCE : Ω  
CAPACITANCE : F

Fig.2

●Pin description  
(BD3402KS2)

Pin No.	Pin Name	Description	Pin No.	Pin Name	Description
1	D1	1ch input pin D	33	VOL OUT1	1ch output pin
2	D2	2ch input pin D	34	NC	Non Connection
3	E1	1ch input pin E	35	NC	Non Connection
4	E2	2ch input pin E	36	VIN1	1ch volume input pin
5	PBNF2	2ch PB filter setting pin	37	TONE OUT1	1ch tone output pin
6	PBOUT2	2ch PB output pin	38	VIN2	2ch volume input pin
7	PBOUT1	1ch PB output pin	39	TONE OUT2	2ch tone output pin
8	PBNF1	1ch PB filter setting pin	40	NC	Non Connection
9	NC	Non Connection	41	BNF2	2ch bass filter setting pin
10	NC	Non Connection	42	BOUT2	2ch bass filter setting pin
11	TAPE 1	1ch TAPE input pin	43	BOUT1	1ch bass filter setting pin
12	TAPE 2	2ch TAPE input pin	44	BNF1	1ch bass filter setting pin
13	RECNF2	2ch REC filter setting pin	45	NC	Non Connection
14	RECOUT2	2ch REC output pin	46	NC	Non Connection
15	RECOUT1	1ch REC output pin	47	NC	Non Connection
16	RECNF1	1ch REC filter setting pin	48	NC	Non Connection
17	ALC	ALC time constant setting pin	49	TNF2	2ch treble filter setting pin
18	SC	Serial clock input pin	50	TNF1	1ch treble filter setting pin
19	SI	Serial data input pin	51	NC	Non Connection
20	VDD	Digital power supply pin	52	NC	Non Connection
21	GND	Ground pin	53	LINEOUT2	2chLINE output pin
22	VCC	Analog power supply pin	54	LINEOUT1	1chLINE output pin
23	NC	Non Connection	55	NC	Non Connection
24	FILTER	1/2 VCC pin	56	NC	Non Connection
25	NC	Non Connection	57	NC	Non Connection
26	NC	Non Connection	58	NC	Non Connection
27	NC	Non Connection	59	A1	1ch input pin A
28	NC	Non Connection	60	A2	2ch input pin A
29	NC	Non Connection	61	B1	1ch input pin B
30	NC	Non Connection	62	B2	2ch input pin B
31	NC	Non Connection	63	C1	1ch input pin C
32	VOL OUT2	2ch output pin	64	C2	2ch input pin C

● Block diagram, application circuit, pin assignment

(BD3402KS2)

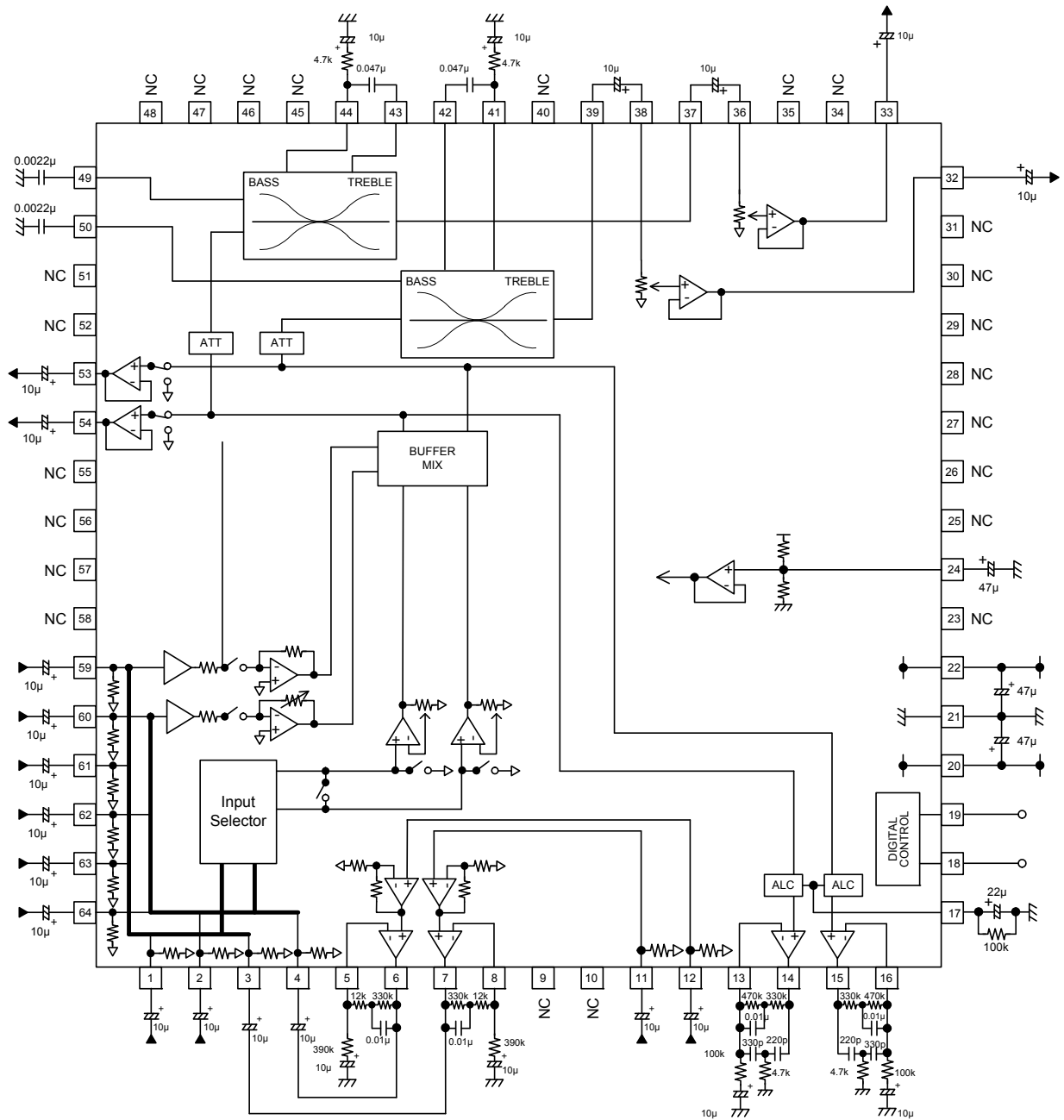

UNIT  
 RESISTANCE : Ω  
 CAPACITANCE : F

Fig.3

●Reference data

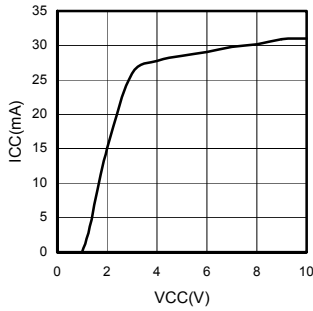

Fig.4 Circuit Current - Supply Voltage (BD3401KS2)

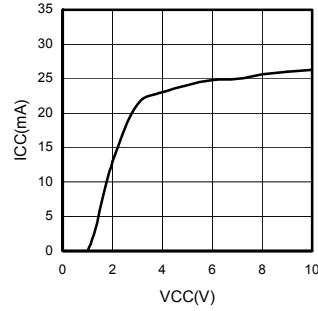

Fig.5 Circuit Current - Supply Voltage (BD3402KS2)

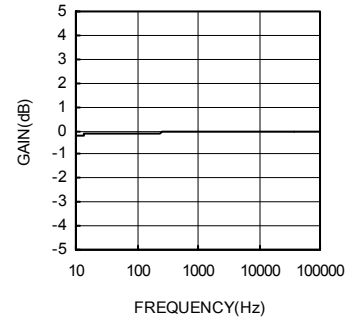

Fig.6 Voltage Gain - Frequency

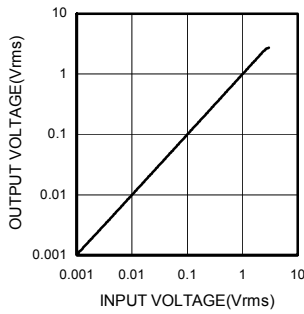

Fig.7 Output Voltage - Input Voltage

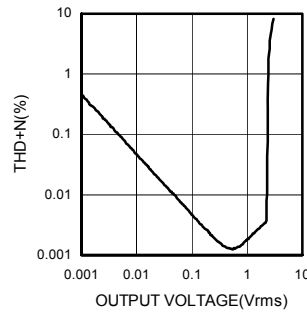

Fig.8 Total Harmonic Distortion ratio - Output Voltage

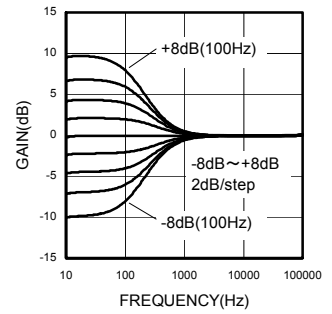

Fig.9 Bass Gain - Frequency (BD3401KS2)

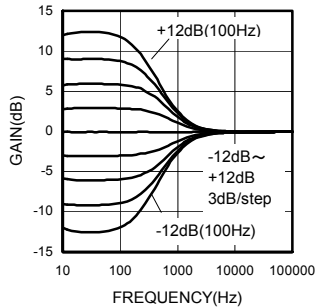

Fig.10 Bass Gain - Frequency (BD3402KS2)

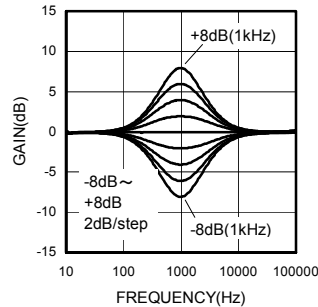

Fig.11 Middle Gain - Frequency (BD3401KS2)

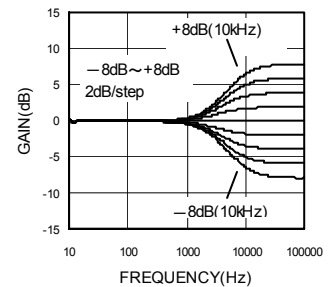

Fig.12 Treble Gain - Frequency

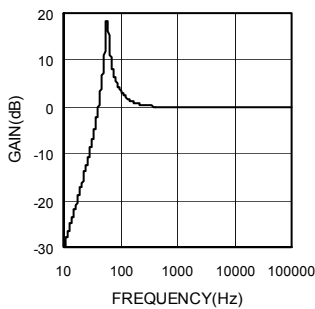

Fig.13 Bass Boost Gain - Frequency (BD3401KS2)

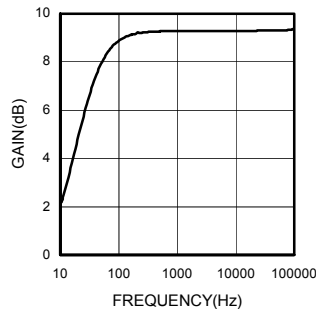

Fig.14 Surround Gain - Frequency (BD3401KS2)

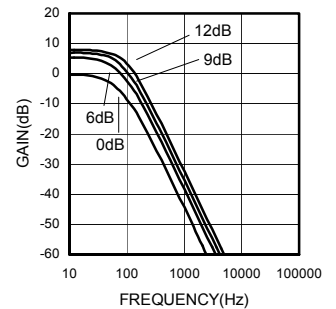

Fig.15 Subwoofer Gain - Frequency (BD3401KS2)

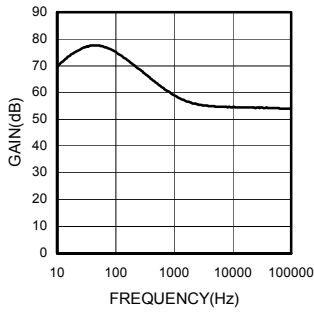

Fig. 16 Amp Gain - Frequency (PB)

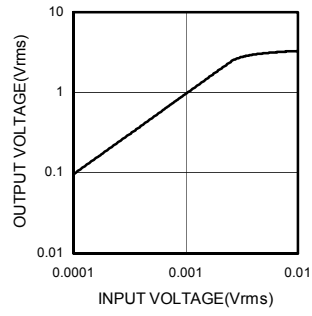

Fig. 17 Output Voltage - Input Voltage (PB)

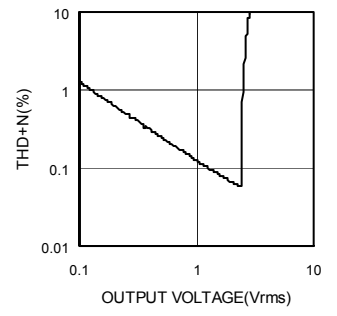

Fig. 18 Total Harmonic Distortion ratio - Output Voltage (PB)

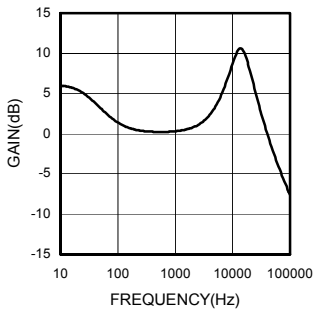

Fig. 19 Amp Gain - Frequency (REC)

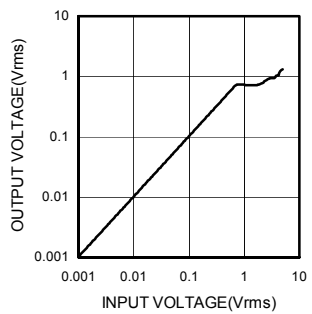

Fig. 20 Output Voltage - Input Voltage (REC)

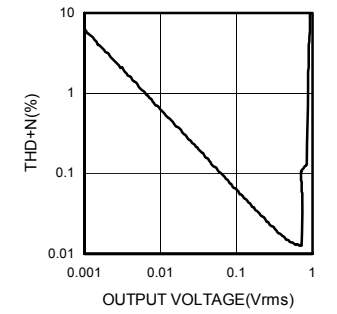

Fig. 21 Total Harmonic Distortion ratio - Output Voltage (REC)

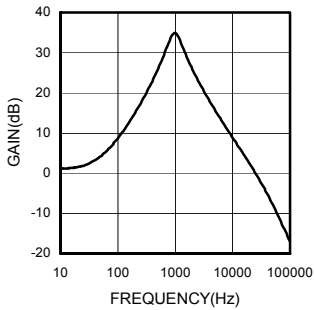

Fig. 22 AMS Gain - Frequency (BD3401KS2)

● Notes for use

- 1) Numbers and data in entries are representative design values and are not guaranteed values of the items.
- 2) Although ROHM is confident that the example application circuit reflects the best possible recommendations, be sure to verify circuit characteristics for your particular application. Modification of constants for other externally connected circuits may cause variations in both static and transient characteristics for external components as well as this Rohm IC. Allow for sufficient margins when determining circuit constants.
- 3) Absolute maximum ratings  
Use of the IC in excess of absolute maximum ratings, such as the applied voltage or operating temperature range (Topr), may result in IC damage. Assumptions should not be made regarding the state of the IC (short mode or open mode) when such damage is suffered. A physical safety measure, such as a fuse, should be implemented when using the IC at times where the absolute maximum ratings may be exceeded.
- 4) GND potential  
Ensure a minimum GND pin potential in all operating conditions. Make sure that no pins are at a voltage below the GND at any time, regardless of whether it is a transient signal or not.
- 5) Thermal design  
Perform thermal design, in which there are adequate margins, by taking into account the permissible dissipation (Pd) in actual states of use.
- 6) Short circuit between terminals and erroneous mounting  
Pay attention to the assembly direction of the ICs. Wrong mounting direction or shorts between terminals, GND, or other components on the circuits, can damage the IC.
- 7) Operation in strong electromagnetic field  
Using the ICs in a strong electromagnetic field can cause operation malfunction.
- 8) Serial control  
For the SC and SI terminals, the wiring and layout patterns should be routed as not to cause interference with the analog-signal-related lines.
- 9) Power ON/OFF  
At power ON/OFF, a shock sound will be generated and, therefore, MUTE shall be applied.
- 10) Start-up sequence of the power supplies  
VDD and VCC should be turned on simultaneously or VDD first, followed by VCC.
- 11) Function switching  
(BD3401KS2)  
For all functions except Master Volume, Treble, Middle, Bass, Surround, and Bass Boost, MUTE must be applied during setup.  
(BD3402KS2)  
For all the functions except Master Volume, Treble and Bass, MUTE must be applied during setup..
- 12) Power-ON Reset  
A built-in circuit for performing initialization inside the IC at power-ON is provided. In unstable systems it is recommended that the data shall be sent to all the addresses during power-ON, until this operation cycle is completed. Mute should be applied during this cycle.

Function	Initial State	BD3401KS2	BD3402KS2
Input Selector	MUTE	○	○
Input Gain	-5dB	○	○
Volume	0dB	○	○
Treble	0dB	○	○
Bass	0dB	○	○
Middle	0dB	○	-
TONE ATT	0dB	○	○
Subwoofer	0dB	○	-
MUX	STEREO	○	○
Mixing	OFF	○	○
Mixing Gain	3dB	○	○
PLAY BACK	TAPE A	○	No selector
REC	OFF	○	○
LINE	OFF	○	○
MIC	OFF	○	-
Bass Boost	OFF	○	-
Surround	OFF	○	-
AMS	OFF	○	-
ALC	OFF	○	○
Vocal Fader	OFF	○	-

13) Constraints of serial control

- (1) On soft-switching of the BASS BOOST, SURROUND and AMS functions, data must not be serially sent to the functions involved before the switching operation is completed.  
Data (1) to (8) can be serially sent immediately after sending Data (9).

For functions that need to use soft-switch, data (Data (9)) can be serially sent on the same select address.

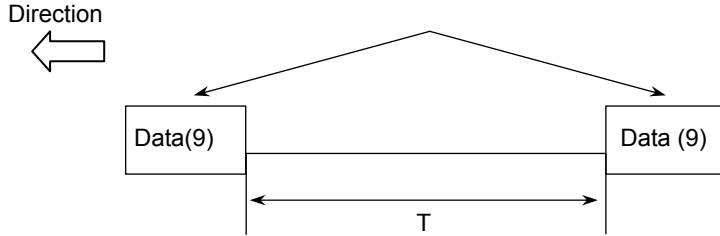

The time interval: T(sec) between Data (9) must be set to have a sufficient delay time. For example, 100ms or more when C on pin57 is 0.33μF.

Fig.23

- (2) When switching AMS ON and OFF, a shock sound will be generated. Using MUTE provided on VOLUME, control data should be sent in order to avoid outputting the shock sound from VOLOUT1,2 (pin32,33) as described in the figure below:

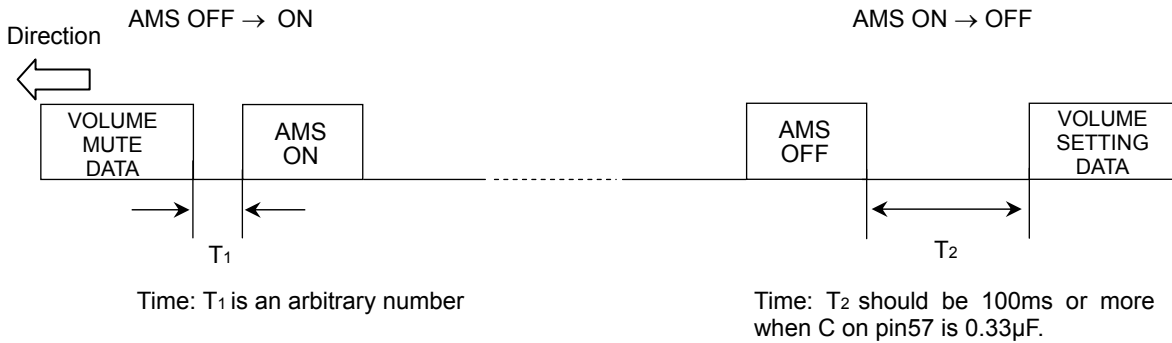
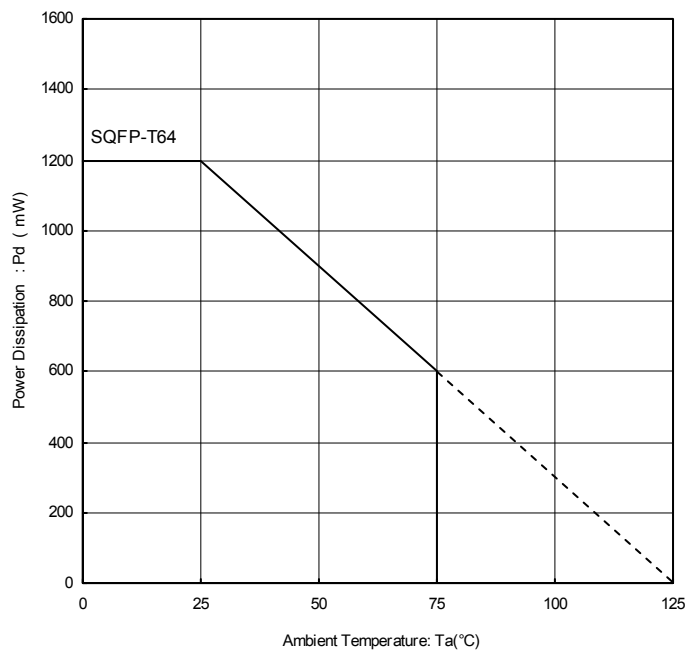

Fig.24



•Thermal derating characteristic



When installed on the ROHM standard board  
(size: 70 × 70 × 1.6mm, Glass epoxy board)

Fig.25

● Ordering part number

B	D
---	---

Part No.

3	4	0	1
---	---	---	---

Part No.  
3401, 3402

K	S	2
---	---	---

Package  
KS2: SQFP-T64

--	--

Packaging and forming specification  
None: Tray

SQFP-T64

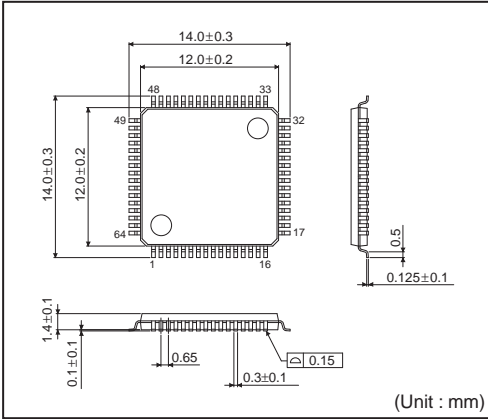

<Tape and Reel information>

Container	Tray (with dry pack)
Quantity	1000pcs
Direction of feed	Direction of product is fixed in a tray

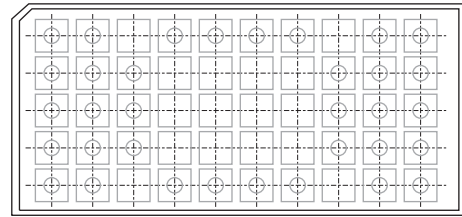
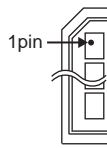

\*Order quantity needs to be multiple of the minimum quantity.

## Notes

No copying or reproduction of this document, in part or in whole, is permitted without the consent of ROHM Co.,Ltd.

The content specified herein is subject to change for improvement without notice.

The content specified herein is for the purpose of introducing ROHM's products (hereinafter "Products"). If you wish to use any such Product, please be sure to refer to the specifications, which can be obtained from ROHM upon request.

Examples of application circuits, circuit constants and any other information contained herein illustrate the standard usage and operations of the Products. The peripheral conditions must be taken into account when designing circuits for mass production.

Great care was taken in ensuring the accuracy of the information specified in this document. However, should you incur any damage arising from any inaccuracy or misprint of such information, ROHM shall bear no responsibility for such damage.

The technical information specified herein is intended only to show the typical functions of and examples of application circuits for the Products. ROHM does not grant you, explicitly or implicitly, any license to use or exercise intellectual property or other rights held by ROHM and other parties. ROHM shall bear no responsibility whatsoever for any dispute arising from the use of such technical information.

The Products specified in this document are intended to be used with general-use electronic equipment or devices (such as audio visual equipment, office-automation equipment, communication devices, electronic appliances and amusement devices).

The Products specified in this document are not designed to be radiation tolerant.

While ROHM always makes efforts to enhance the quality and reliability of its Products, a Product may fail or malfunction for a variety of reasons.

Please be sure to implement in your equipment using the Products safety measures to guard against the possibility of physical injury, fire or any other damage caused in the event of the failure of any Product, such as derating, redundancy, fire control and fail-safe designs. ROHM shall bear no responsibility whatsoever for your use of any Product outside of the prescribed scope or not in accordance with the instruction manual.

The Products are not designed or manufactured to be used with any equipment, device or system which requires an extremely high level of reliability the failure or malfunction of which may result in a direct threat to human life or create a risk of human injury (such as a medical instrument, transportation equipment, aerospace machinery, nuclear-reactor controller, fuel-controller or other safety device). ROHM shall bear no responsibility in any way for use of any of the Products for the above special purposes. If a Product is intended to be used for any such special purpose, please contact a ROHM sales representative before purchasing.

If you intend to export or ship overseas any Product or technology specified herein that may be controlled under the Foreign Exchange and the Foreign Trade Law, you will be required to obtain a license or permit under the Law.



Thank you for your accessing to ROHM product informations.  
More detail product informations and catalogs are available, please contact us.

## ROHM Customer Support System

<http://www.rohm.com/contact/>