



DTA143Z

PNP SILICON TRANSISTOR

DIGITAL TRANSISTORS (BUILT- IN BIAS RESISTORS)

■ FEATURES

- * Built-in bias resistors that implies easy ON/OFF applications.
- * The bias resistors are thin-film resistors with complete isolation to allow positive input.

■ EQUIVALENT CIRCUIT

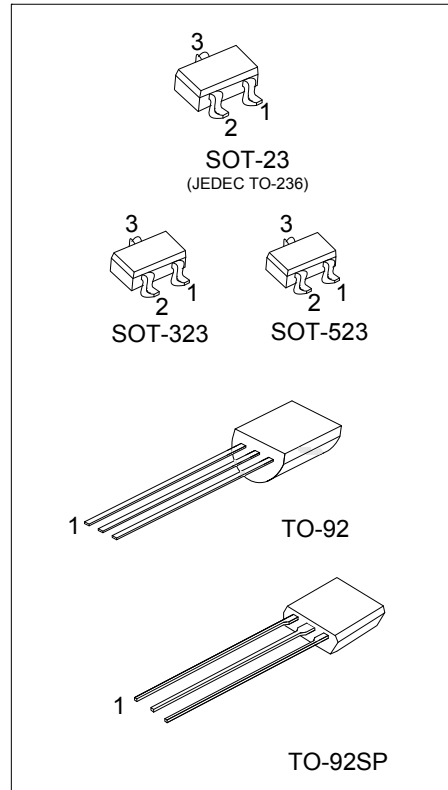
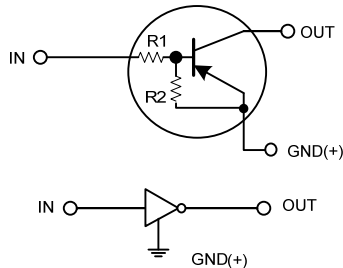

■ ORDERING INFORMATION

Ordering Number		Package	Pin Assignment			Packing
Lead Free	Halogen Free		1	2	3	
DTA143ZL-AE3-R	DTA143ZG-AE3-R	SOT-23	G	I	O	Tape Reel
DTA143ZL-AL3-R	DTA143ZG-AL3-R	SOT-323	G	I	O	Tape Reel
DTA143ZL-AN3-R	DTA143ZG-AN3-R	SOT-523	G	I	O	Tape Reel
DTA143ZL-T92-B	DTA143ZG-T92-B	TO-92	G	O	I	Tape Box
DTA143ZL-T92-K	DTA143ZG-T92-K	TO-92	G	O	I	Bulk
DTA143ZL-T92-R	DTA143ZG-T92-R	TO-92	G	O	I	Tape Reel
DTA143ZL-T9S-K	DTA143ZG-T9S-K	TO-92SP	G	O	I	Bulk

<p>DTA143ZL-AE3-R</p> <p>(1)Packing Type (2)Package Type (3)Lead Free</p>	<p>(1) B: Tape Box, K: Bulk, R: Tape Reel (2) AE3: SOT-23, AL3: SOT-323, AN3: SOT-523, T92: TO-92, T9S: TO-92SP (3) G: Halogen Free, L: Lead Free</p>
---	---

■ MARKING (FOR SOT-23/SOT-323/SOR-523 PACKAGE)

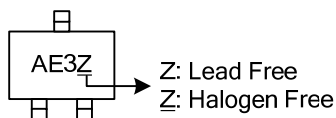

■ ABSOLUTE MAXIMUM RATINGS ($T_A = 25^\circ\text{C}$)

PARAMETER		SYMBOL	RATINGS	UNIT
Supply Voltage		V_{CC}	-50	V
Input Voltage		V_{IN}	-30 ~ +5	V
Output Current		$I_{OUT(MAX)}$	-100	mA
Power Dissipation	SOT-523	P_D	150	mW
	SOT-23/SOT-323		200	
	TO-92		625	
	TO-92SP		550	
Junction Temperature		T_J	150	$^\circ\text{C}$
Storage Temperature		T_{STG}	-55 ~ +150	$^\circ\text{C}$

Note Absolute maximum ratings are those values beyond which the device could be permanently damaged.

Absolute maximum ratings are stress ratings only and functional device operation is not implied.

■ ELECTRICAL CHARACTERISTICS ($T_A = 25^\circ\text{C}$, unless otherwise specified.)

PARAMETER	SYMBOL	TEST CONDITIONS	MIN	TYP	MAX	UNIT
Input Voltage	$V_{IN(OFF)}$	$V_{CC} = -5V, I_{OUT} = -100\mu\text{A}$			-0.5	V
	$V_{IN(ON)}$	$V_{OUT} = -0.3V, I_{OUT} = -5\text{mA}$	-3			
Output Voltage	$V_{OUT(ON)}$	$I_{OUT}/I_{IN} = -5\text{mA}/-0.25\text{mA}$		-0.1	-0.3	V
Input Current	I_{IN}	$V_{IN} = -5V$			-1.8	mA
Output Current	$I_{OUT(OFF)}$	$V_{CC} = -50V, V_{IN} = 0V$			-0.5	μA
DC Current Gain	h_{FE}	$V_{OUT} = -5V, I_{OUT} = -10\text{mA}$	80			
Input Resistance	R_1		3.29	4.7	6.11	k Ω
Resistance Ratio	R_2/R_1		8	10	12	
Transition Frequency	f_T	$V_{CE} = -10V, I_E = -5\text{mA}, f = 100\text{MHz}$ (Note)		250		MHz

Note: Transition frequency of the device

TYPICAL CHARACTERISTICS

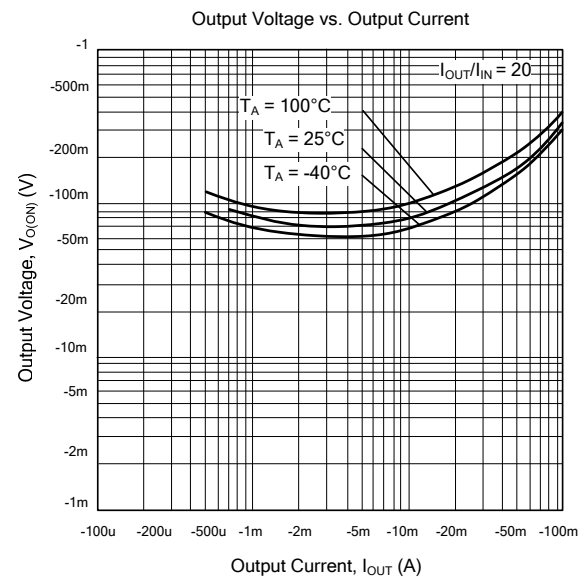
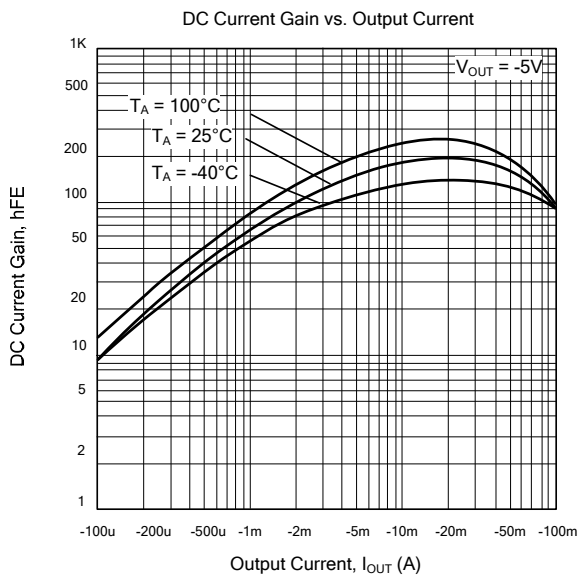
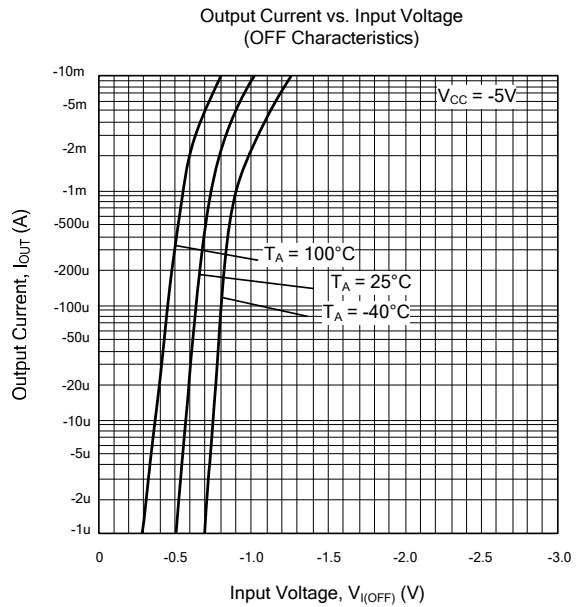
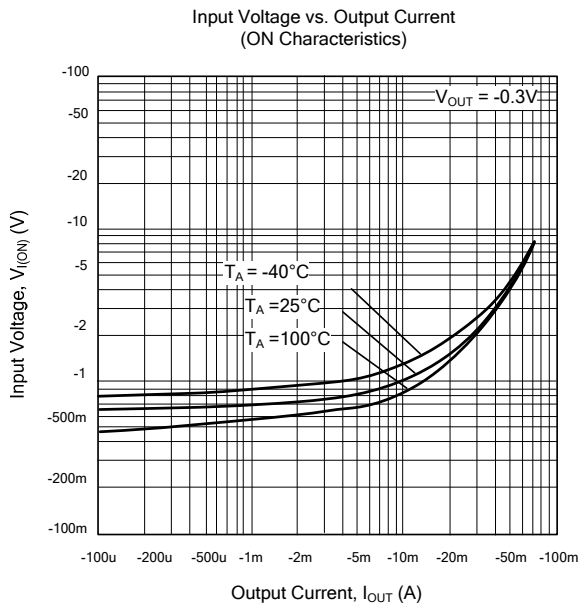

UTC assumes no responsibility for equipment failures that result from using products at values that exceed, even momentarily, rated values (such as maximum ratings, operating condition ranges, or other parameters) listed in products specifications of any and all UTC products described or contained herein. UTC products are not designed for use in life support appliances, devices or systems where malfunction of these products can be reasonably expected to result in personal injury. Reproduction in whole or in part is prohibited without the prior written consent of the copyright owner. The information presented in this document does not form part of any quotation or contract, is believed to be accurate and reliable and may be changed without notice.