

DATA SHEET

TDA9725

**Y/C automatic adjustment
processor (VHS standard)**

Product specification
Supersedes data of 1995 Dec 06
File under Integrated Circuits, IC02

1996 Oct 14

Y/C automatic adjustment processor (VHS standard)

TDA9725

FEATURES

- Automatic adjustment by control loops
- Integrated filters
- Simple SVHS playback
- Colour sequence correction for long-play still mode
- Automatic gain control for FM.

GENERAL DESCRIPTION

The TDA9725 is an integrated circuit for chrominance and luminance processing (record and playback) in VHS tape recorders for PAL, SECAM/ME and NTSC systems (4.43 MHz playback only) with internal filter and without adjustments.

QUICK REFERENCE DATA

SYMBOL	PARAMETER	CONDITIONS	MIN.	TYP.	MAX.	UNIT
V_{CC}	supply voltage		4.5	5.0	5.5	V
I_{CC}	supply current	$V_{CC} = 5\text{ V}$; playback	140	170	200	mA
$V_{i(p-p)}$	video input voltage; CVBS signal (peak-to-peak value)		0.6	1.0	2.0	V
$V_{oREC(p-p)}$	video output record voltage (peak-to-peak value)	video/sync = 7/3	2.03	2.14	2.25	V
$V_{oPB(p-p)}$	video output playback voltage (peak-to-peak value)	video/sync = 7/3; nominal FM signal	2.03	2.14	2.25	V
$V_{iFM(p-p)}$	FM input voltage (peak-to-peak value)	FM AGC active	63	200	632	mV
$V_{oFM(p-p)}$	FM output voltage (peak-to-peak value)	$R_L = 1\text{ k}\Omega$	0.7	0.9	1.1	V
$V_{CFT(p-p)}$	chrominance input voltage (+FM) from tape (peak-to-peak value)		11	110	310	mV
$V_{CTT(p-p)}$	chrominance output voltage to tape (peak-to-peak value)		467	660	932	mV
T_{stg}	storage temperature		-25	-	+150	°C
T_{amb}	operating ambient temperature		-20	-	+70	°C

ORDERING INFORMATION

TYPE NUMBER	PACKAGE		
	NAME	DESCRIPTION	VERSION
TDA9725	SDIP52	plastic shrink dual in-line package; 52 leads (600 mil)	SOT247-1

Y/C automatic adjustment processor (VHS standard)

TDA9725

BLOCK DIAGRAM

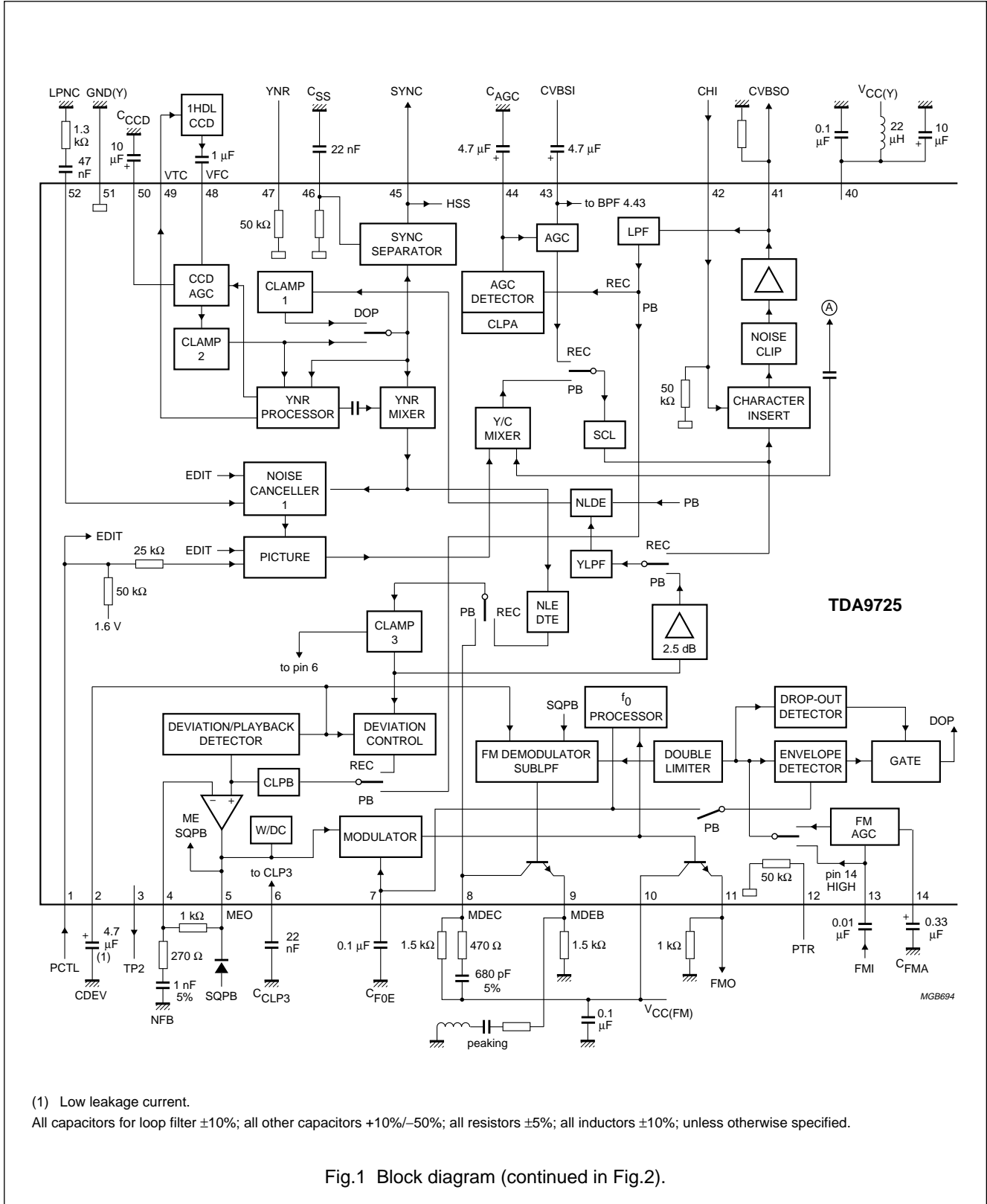

(1) Low leakage current.

All capacitors for loop filter ±10%; all other capacitors +10%/−50%; all resistors ±5%; all inductors ±10%; unless otherwise specified.

Fig.1 Block diagram (continued in Fig.2).

Y/C automatic adjustment processor
(VHS standard)

TDA9725

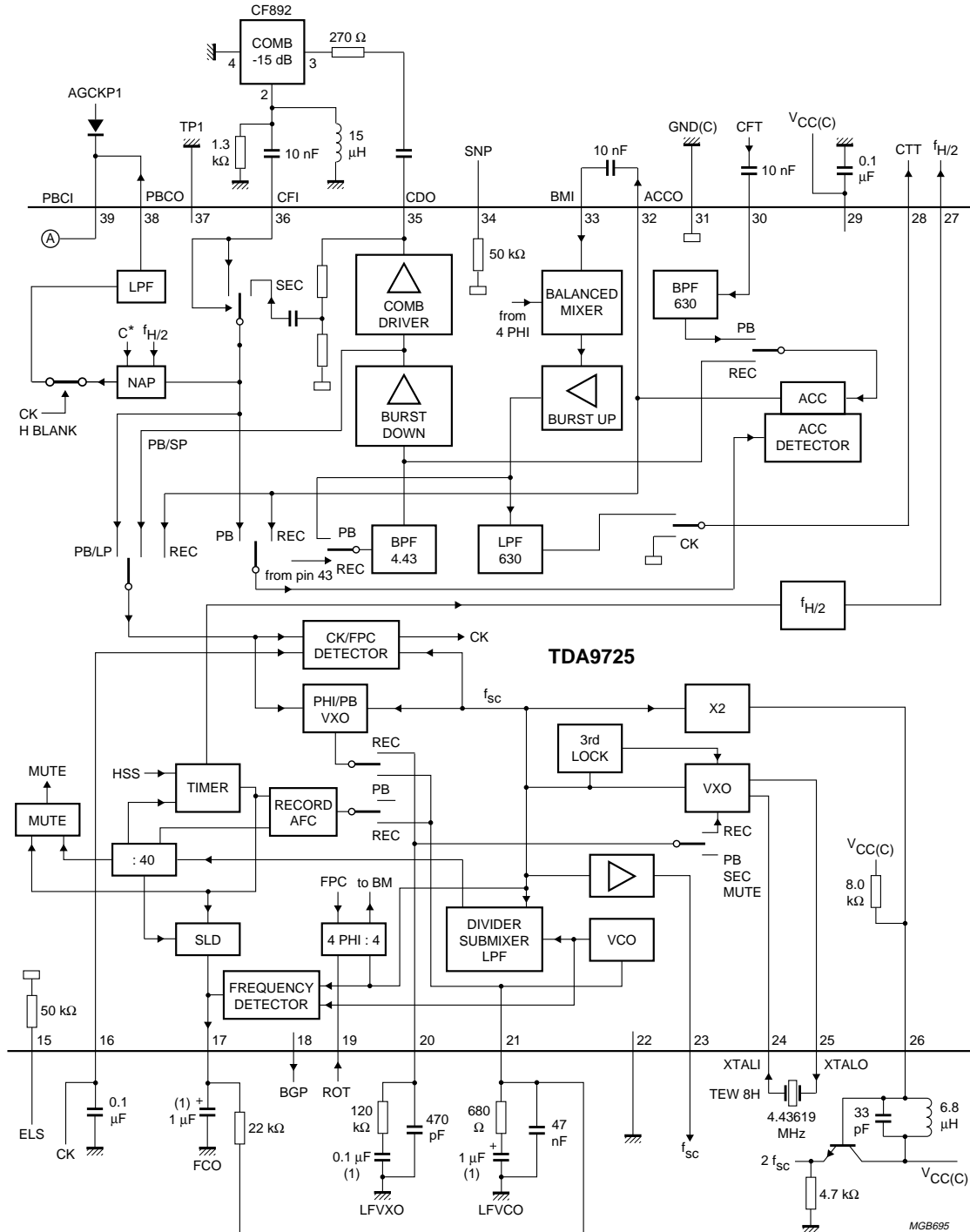

(1) Low leakage current.

Fig.2 Block diagram (continued from Fig.1).

Y/C automatic adjustment processor (VHS standard)

TDA9725

Table 1 Explanation of symbols in Figs 1 and 2

SYMBOL	DESCRIPTION
AGCKP1	mode with shortened key pulse for AGC
BGP	burst gate pulse
DOP	dropout pulse
f_H	line frequency
f_{sc}	subcarrier frequency (4.433619 MHz)
HDL CCD	charged coupled device with 1H delay
NLDE	non-linear de-emphasis
NLEDTE	non-linear emphasis/detail enhancer
ROT	rotary pulse
VXO	voltage controlled XTAL oscillator
YNR	vertical noise reduction
YLPF	luminance low-pass filter

PINNING

SYMBOL	PIN	DESCRIPTION
PCTL	1	picture control/edit switch input
CDEV	2	deviation/playback AGC detector input
TP2	3	test pin 2/correlation detector output
NFB	4	negative feedback input of main emphasis
MEO	5	main emphasis output/white clip/modulator input/SQPB selector
C_{CLP3}	6	capacitor for clamp 3
C_{FOE}	7	storage capacitor for f_0 processor (record)/envelope detector (playback)
MDEC	8	main de-emphasis output
MDEB	9	main de-emphasis and peaking output
$V_{CC(FM)}$	10	FM supply voltage
FMO	11	FM output
PTR	12	switch (PB/TRICK/REC)
FMI	13	playback FM input
C_{FMA}	14	storage capacitor for FM AGC
ELS	15	PAL: switch (LP C*/LP/SP); NTSC: switch (EP/LP/SP)
CK	16	colour killer terminal
FCO	17	frequency correction output
BGP	18	burst gate pulse output

SYMBOL	PIN	DESCRIPTION
ROT	19	rotary pulse input
LFVXO	20	loop filter VXO
LFVCO	21	loop filter VCO
n.c.	22	not connected; note 1
f_{sc}	23	f_{sc} output
XTALI	24	VXO input from crystal
XTALO	25	VXO output to crystal
$2f_{sc}$	26	$2f_{sc}$ output
$f_{H/2}$	27	$f_{H/2}$ output
CTT	28	chrominance output to tape
$V_{CC(C)}$	29	chrominance supply voltage
CFT	30	playback chrominance input from tape
GND(C)	31	chrominance ground
ACCO	32	automatic chrominance control output
BMI	33	balanced mixer input
SNP	34	switch (SECAM/NTSC/PAL)
CDO	35	comb driver output
CFI	36	chrominance input from comb filter
TP1	37	test pin 1; note 1
PBCO	38	playback chrominance output
PBCI	39	playback chrominance input
$V_{CC(Y)}$	40	luminance supply voltage
CVBSO	41	CVBS output
CHI	42	character insertion input (artificial sync/black/white/through)
CVBSI	43	CVBS input
C_{AGC}	44	AGC detector capacitor
SYNC	45	sync separator push-pull output
C_{SS}	46	sync separator detector capacitor
YNR	47	YNR switch
VFC	48	video input from 1HDL CCD
VTC	49	video output to 1HDL CCD
C_{CCD}	50	storage capacitor for CCD AGC level
GND(Y)	51	luminance ground
LPNC	52	low-pass filter noise canceller

Note

1. It is recommended that this pin should be connected to ground.

Y/C automatic adjustment processor
(VHS standard)

TDA9725

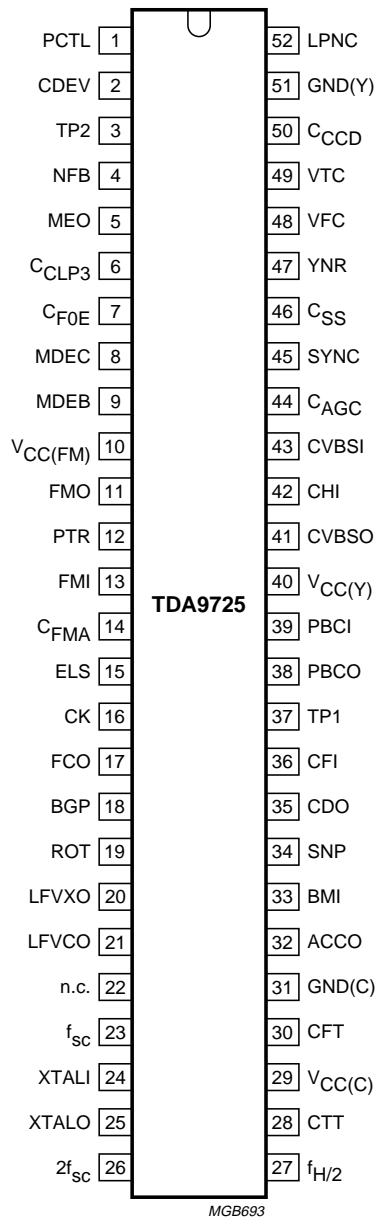

Fig.3 Pin configuration.

Y/C automatic adjustment processor (VHS standard)

TDA9725

FUNCTIONAL DESCRIPTION

Record (REC)/electric to electric (EE) mode

LUMINANCE

From input pin 43 the CVBS signal is fed via the automatic gain control (AGC) and subclamp (SCL) to the output pin 41. Instead of the controlled and clamped CVBS signal it is also possible to switch (dependent on the level at pin 42) white, black or sync-level to this pin. To eliminate chrominance parts the CVBS signal is fed to the luminance low-pass filter (YLPF) and to the sync separator stage. The sync signal is available at pin 45. The signal is also fed via vertical emphasis non-linear emphasis (NLE), deviation control stage, main emphasis and white-dark clip to the FM modulator. The FM signal is available at pin 11.

CHROMINANCE

The chrominance signal is selected out of CVBS (from pin 43) in BPF 4.43 MHz (band-pass filter) and controlled in automatic chrominance control (ACC).

The chrominance signal is mixed with 5.06 MHz to 627 kHz and via LPF 627 kHz to the output pin 30.

Playback (PB)/video to video (VV) mode

LUMINANCE

The FM signal is fed via FM AGC and double limiter to the controlled FM demodulator. After demodulation and filtering in sub low-pass filter (SUBLPF) main de-emphasis, YLPF and non-linear de-emphasis the signal is fed to the vertical noise reduction (YNR) and in parallel to the sync separator. The chrominance signal is added in the Y/C mixer. The complete CVBS signal is available at pin 41.

CHROMINANCE

The 627 kHz chrominance signal coming from tape via BPF 627 kHz and field ACC to the balanced mixer. Mixed with 5.06 MHz the 4.43 MHz chrominance signal is fed via comb driver stage to the external comb filter (pin 35) and via internal conjugated complex (C*) stage and internal AC coupling to the luminance part.

Record and playback

In both modes record (REC) and playback (PB) the 5.06 MHz mixer frequency is produced by the 20.24 MHz voltage controlled oscillator (VCO) and a divide-by-four.

LIMITING VALUES

In accordance with the Absolute Maximum Rating System (IEC 134).

SYMBOL	PARAMETER	CONDITIONS	MIN.	TYP.	MAX.	UNIT
V _{CC}	supply voltage		0	–	6.0	V
V _I	input voltage at pin 22		0	–	1.6	V
V _n	input voltage on all other pins		0	–	V _{CC}	V
I _I	input current at pin 22		–	–	10	mA
P _{tot}	total power dissipation		–	–	1250	mW
T _{stg}	storage temperature		–25	–	+150	°C
T _{amb}	operating ambient temperature		–20	–	+70	°C
V _{es}	electrostatic handling for all pins	note 1	–300	–	+300	V

Note

- Charge device model class B: discharging a 200 pF capacitor via a 0 Ω series resistor.

THERMAL CHARACTERISTICS

SYMBOL	PARAMETER	VALUE	UNIT
R _{th j-a}	thermal resistance from junction to ambient in free air	43	K/W

Y/C automatic adjustment processor (VHS standard)

TDA9725

CHARACTERISTICS

$V_{CC} = 5\text{ V}$; $T_{amb} = +25\text{ °C}$ and typical application (see Figs 1 and 2), unless otherwise specified.

Luminance part: All amplitudes are VBS peak-to-peak values, unless otherwise specified.

Chrominance part: All amplitudes for PAL and NTSC are red values with 75% saturation and chrominance-to-burst ratio of 2.2 : 1, unless otherwise specified.

SYMBOL	PARAMETER	CONDITIONS	MIN.	TYP.	MAX.	UNIT
Supplies						
V_{CC}	supply voltage		4.5	5.0	5.5	V
I_{PB}	current consumption ($I_{10} + I_{29} + I_{40}$)	playback mode	140	170	200	mA
I_{REC}	current consumption ($I_{10} + I_{29} + I_{40}$)	record mode	125	155	185	mA
FM SUPPLY (PIN 10)						
I_{PB}	DC playback current		–	22	–	mA
I_{REC}	DC record current		–	12	–	mA
CHROMINANCE SUPPLY (PIN 29)						
$I_{CC(C)}$	DC supply current	playback mode	–	85	–	mA
		record mode	–	85	–	mA
LUMINANCE SUPPLY (PIN 40)						
I_{PB}	DC playback current		–	63	–	mA
I_{REC}	DC record current		–	57	–	mA
Picture control/edit switch input (pin 1)						
V_1	DC input voltage	pin open-circuit	–	1.6	–	V
		sharp picture	0	–	1.6	V
		soft picture	1.6	–	3.2	V
		edit mode	4.1	–	5.0	V
Deviation/playback AGC detector input (pin 2)						
V_2	detection voltage		1.8	2.5	3.2	V
Test pin 2/correlation detector output (pin 3)						
V_{OH}	HIGH level output voltage	correlation of Y signal; pin 37 LOW; $R_L \geq 10\text{ k}\Omega$	1.5	2.1	3.0	V
V_{OL}	LOW level output voltage	non-correlation of Y signal	–	0.1	0.5	V

Y/C automatic adjustment processor (VHS standard)

TDA9725

SYMBOL	PARAMETER	CONDITIONS	MIN.	TYP.	MAX.	UNIT
Negative feedback input of main emphasis (pin 4; open-base) and main emphasis output/white-clip/modulator/SQPB selector (pin 5)						
FEEDBACK LOOP CLOSED (PIN 4 CONNECTED TO PIN 5; MAIN EMPHASIS OFF)						
V _{SY}	DC voltage level	sync tip	–	1.9	–	V
V _{oREC(p-p)}	record output voltage level; standard output level (peak-to-peak value)	video/sync = 7/3; $\Delta V_{CC} = \pm 0.25$ V; T _{amb} = –10 to +70 °C	450	500	550	mV
t _{FRAMEDET}	time for correcting carrier interleave relationship to half picture	HIGH during half picture 1; note 1	–	–	200	ms
NON-LINEAR EMPHASIS/DETAIL ENHANCER; notes 2 and 3						
RD1	response D1	–20 dB; f _i = 500 kHz; SP; NORM	1.7	2.7	3.7	dB
RD2	response D2	–20 dB; f _i = 2 MHz; SP; NORM	6.0	7.5	9.0	dB
RS1	response S1	–20 dB; f _i = 500 kHz; SP; EDIT	1.0	1.7	2.4	dB
RS1	response S2	–20 dB; f _i = 2 MHz; SP; EDIT	4.5	5.5	6.5	dB
RL1	response L1	–20 dB; f _i = 500 kHz; LP	3.1	4.4	5.7	dB
RL2	response L2	–20 dB; f _i = 2 MHz; LP	7.0	9.0	11	dB
RL3	response L3	0 dB; f _i = 2 MHz; LP	1.6	2.3	3.0	dB
VERTICAL EMPHASIS						
PL1	peak level 1	–30 dB recursive; note 4	3.5	4.3	5.3	dB
PL2	peak level 2	–20 dB recursive; note 4	3.5	4.0	4.5	dB
PL3	peak level 3	0 dB recursive	0	0.4	1.0	dB
FEEDBACK LOOP NORMAL APPLICATION						
DCL	dark-clip level		50	60	70	%
WCL	white-clip level		180	187	194	%
V ₅	SQPB input voltage	playback mode	4.0	–	–	V
Record storage capacitor for f₀ processor and playback storage capacitor for envelope detector (pin 7)						
V _I	DC voltage	record mode	–	1.2	–	V
V _{NOR}	DC voltage of normal mode	playback mode; V _i = 350 mV (p-p); pin 14 HIGH	2.3	3.3	4.0	V
V _{OFF}	DC voltage of dropout correction (DOC) off mode	playback mode	0	–	1.3	V
V _{NS}	DC voltage at no input signal	playback mode	1.1	1.6	2.1	V
G _{Eon}	envelope detector switch-on level (dropout active)	playback mode; 0 dB = V _i = 350 mV (p-p); f _i = 3.8 MHz; pin 14 HIGH	–13	–10	–7	dB
t _{env}	envelope detector operating time	C _i = 0.1 μF	380	500	620	μs

Y/C automatic adjustment processor (VHS standard)

TDA9725

SYMBOL	PARAMETER	CONDITIONS	MIN.	TYP.	MAX.	UNIT
Main de-emphasis output (pin 8; open collector)						
V ₈	DC output voltage	f _i = 3.8 MHz at VHS	2.9	3.4	3.9	V
V _{VID(p-p)}	video output voltage level (peak-to-peak value)	f _{DEV} = 1 MHz	230	300	370	mV
Φ _{DEM}	demodulator sensitivity	VHS mode	0.23	0.3	0.37	V/MHz
		SQPB mode	0.14	0.19	0.24	V/MHz
LIN1	demodulator linearity 1 $\frac{V_0(5\text{ MHz}) - V_0(4\text{ MHz})}{V_0(4\text{ MHz}) - V_0(3\text{ MHz})}$	VHS mode	0.97	1.0	1.03	
LIN2	demodulator linearity 2 $\frac{V_0(9\text{ MHz}) - V_0(7\text{ MHz})}{V_0(7\text{ MHz}) - V_0(5\text{ MHz})}$	SQPB mode	0.90	1.0	1.07	
Main de-emphasis and peaking output (pin 9)						
V ₉	DC output voltage	f _i = 3.8 MHz at VHS	1.1	1.6	2.1	V
V _{VR(p-p)}	reverse video voltage level (peak-to-peak value)		230	300	370	mV
α _{DEM}	suppression of demodulated carrier		40	–	–	dB
FM output (pin 11)						
V ₁₁	DC mean value output voltage	R _L = 1 kΩ	2.9	3.2	3.5	V
V _{11(p-p)}	output voltage level (peak-to-peak value)	R _L = 1 kΩ	0.7	0.9	1.1	V
f _{sync}	sync output frequency	V ₅ = V _{sync} ; V ₄₃ = 0 dB	3.75	3.8	3.85	MHz
Δf _{sync}	stability of sync output frequency	ΔV _{CC} = ±0.25 V or T _{amb} = –10 to +70 °C	–20	–	+20	kHz
f _{dev}	frequency deviation	V ₅ = V _{white} ; V ₄₃ = 0 dB; video/sync = 7/3	0.95	1.0	1.05	MHz
Δf _{dev}	stability of frequency deviation	ΔV _{CC} = ±0.25 V or T _{amb} = –10 to +70 °C	–20	–	+20	kHz
Δf _{rot}	carrier interleave frequency	rotary pulse (pin 19) HIGH/LOW; at SP and LP	6.8	7.8	8.8	kHz
H ₂	second harmonic distortion	f _i = 3.8 MHz	–	–50	–42	dB
L _{mod}	modulator linearity		0.95	1.00	1.05	

Y/C automatic adjustment processor (VHS standard)

TDA9725

SYMBOL	PARAMETER	CONDITIONS	MIN.	TYP.	MAX.	UNIT
Switch: PB/TRICK/REC (pin 12)						
R_I	internal resistance to ground		40	50	60	$k\Omega$
V_{PB}	voltage range for active playback mode		3.5	–	5	V
V_{TR}	voltage range for active trick mode		1.75	–	3	V
V_{REC}	voltage range for active record mode		0	–	1.25	V
Playback FM input (pin 13)						
V_{13}	DC voltage		1.7	2.2	2.7	V
$V_{i(p-p)}$	input voltage level (peak-to-peak value)	FM AGC active	63	200	632	mV
		FM AGC not active; pin 14 HIGH	–	350	–	mV
$V_{iBO(p-p)}$	boundary input voltage (peak-to-peak value)	$f_i = 3.8$ MHz; pin 14 HIGH	10	–	1000	mV
G_{DOC}	DOC on level	$V_i = 350$ mV (p-p); $f_i = 3.8$ MHz; pins 7 and 14 HIGH	–18	–15	–12	dB
ΔG_{hys}	DOC on/off hysteresis	$V_i = 350$ mV (p-p); $f_i = 3.8$ MHz; pins 7 and 14 HIGH	1	3	5	dB
G_{Eon}	envelope detector switch-on level	playback mode; 0 dB = $V_i = 350$ mV (p-p); $f_i = 3.8$ MHz; pin 14 HIGH	–13	–10	–7	dB
Storage capacitor for FM AGC (pin 14; playback mode)						
V_{14}	DC voltage	AGC on	2.6	3.1	3.6	V
	DC input voltage	AGC off	4.3	–	5.0	V
Switch LP C*/LP/SP at PAL; EP/LP/SP at NTSC (pin 15)						
R_I	internal resistance to ground		40	50	60	$k\Omega$
V_C	input voltage for active C* (conjugated complex chrominance signal)	PAL	3.5	–	5	V
V_E	input voltage for active EP	NTSC	3.5	–	5	V
V_L	input voltage for active LP		1.75	–	3	V
V_S	input voltage for active SP		0	–	1.25	V

Y/C automatic adjustment processor (VHS standard)

TDA9725

SYMBOL	PARAMETER	CONDITIONS	MIN.	TYP.	MAX.	UNIT
Colour killer terminal (pin 16)						
V_{NC}	DC voltage black and white	luminance input without chrominance	1.6	1.8	2.0	V
V_{16}	input voltage	forced colour off	0	–	1.5	V
		forced colour on	3.0	–	4.3	V
V_{th}	threshold voltage	colour on	2.0	2.2	2.4	V
CK_{th}	colour killer threshold	relative to nominal input; $V_{30} = 110$ mV (p-p)	–25	–30	–35	dB
CK_{hys}	colour killer hysteresis	relative to nominal input; $V_{30} = 110$ mV (p-p)	1	3	5	dB
Frequency correction output (pin 17)						
V_{17}	operating range		0.8	–	4.2	V
I_{oSLD}	SLD output current	SLD	± 12	± 17	± 22	μA
t_{SLD}	SLD pulse duration	SLD	–	1	–	t_H
f_{SLH}	start of detection at positive frequency deviation (referenced to $f_{sc} + N \times f_H$ at pin 35; $-I_{17}$)	SLD/PAL	1.0	2.0	3.0	kHz
		SLD/NTSC	2.0	4.0	5.0	kHz
f_{SLL}	start of detection at negative frequency deviation (referenced to $f_{sc} + N \times f_H$ at pin 35; $+I_{17}$)	SLD/PAL	–3.0	–2.0	–1.0	kHz
		SLD/NTSC	–5.0	–4.0	–2.0	kHz
I_{ofDET}	output current of frequency detector	FDET	± 12	± 17	± 22	μA
t_{fDET}	frequency detector pulse duration	FDET	68	73	78	μs
f_{fDETH}	start of detection at positive frequency deviation (referenced to $f_{sc} + N \times f_H$ at pin 35; $-I_{17}$)	record mode	40	70	100	kHz
f_{fDETL}	start of detection at negative frequency deviation (referenced to $f_{sc} + N \times f_H$ at pin 35; $+I_{17}$)	record mode	–100	–70	–40	kHz

Y/C automatic adjustment processor (VHS standard)

TDA9725

SYMBOL	PARAMETER	CONDITIONS	MIN.	TYP.	MAX.	UNIT
Burst gate pulse output (or sandcastle output; pin 18); note 5						
t _{BGP}	burst gate pulse duration		4.2	4.45	4.7	μs
t _{BGS}	start of burst gate beyond sync start at pin 45		3.25	3.5	3.75	μs
V _{O(L)}	LOW level DC output voltage	inactive; I ₁₈ = 1 mA	–	–	0.7	V
		inactive; I ₁₈ = 0 mA	–	–	0.5	V
V _{O(M)}	medium level DC output voltage	horizontal blanking; 10 kΩ connected to V _{CC}	2.2	2.6	3.0	V
V _{O(H)}	HIGH level DC output voltage	BGP; I ₁₈ = –0.4 mA	4.0	4.4	–	V
		BGP; I ₁₈ = 0 mA	4.6	–	–	V
t _{VBL(start)}	vertical blanking of BGP start	referring to first equalisation pulse in mid of line	–	0	–	t _H
t _{VBL(stop)}	vertical blanking of BGP stop	referring to rotary transition	23	–	–	t _H
		referring to last equalisation pulse in mid of line	1	–	–	t _H
Rotary pulse input (pin 19; open PNP base)						
V _{C2}	voltage for –90° phase rotation	channel 2	0	–	2.25	V
V _{C1}	voltage for non-rotation (PAL) or +90° rotation (NTSC)	channel 1	2.75	–	5	V
Loop filter VXO (pin 20; record mode)						
V ₂₀	DC voltage		1	2.4	3.6	V
Φ _{VXO}	VXO sensitivity		–1.6	–1.2	–0.8	Hz/mV
f _{PI(U)}	upper pull-in frequency		0.6	1.0	1.8	kHz
f _{PI(L)}	lower pull-in frequency		–1.8	–1.0	–0.6	kHz
Loop filter VCO (pin 21)						
V ₂₁	DC voltage		1.3	2.1	2.9	V
Φ _{VCO}	VCO sensitivity	f _H related; record mode	–34	–38	–42	kHz/V
		f _{sc} related; playback mode	–1.3	–1.5	–1.7	MHz/V
f_{sc} output (pin 23)						
V ₂₃	DC output voltage		1.8	2.3	2.8	V
V _{o(p-p)}	output signal voltage (peak-to-peak value)	no load	500	600	700	mV
H ₂	second harmonic distortion		–	–	–25	dB
H ₃	third harmonic distortion		–	–	–20	dB
VXO input from crystal (pin 24); note 6						
V ₂₄	DC voltage		2.6	3.0	3.4	V

Y/C automatic adjustment processor (VHS standard)

TDA9725

SYMBOL	PARAMETER	CONDITIONS	MIN.	TYP.	MAX.	UNIT
VXO output to crystal (pin 25)						
V ₂₅	DC output voltage		2.9	3.3	3.7	V
Δf _{osc}	deviation of oscillator frequency	due to internal spread; playback mode	-50	-	+50	Hz
		video signal without burst; record mode	-1.4	-	+1.4	kHz
		no video signal; record mode	-100	-	+100	Hz
		V _{CC} = 4.75 to 5.25 V; T _{amb} = -10 to +70 °C; playback mode	-100	-	+100	Hz
2f_{sc} output (pin 26)						
V ₂₆	DC output voltage		4.5	4.9	-	V
V _o	output signal voltage	1.2 kΩ connected to V _{CC} and emitter follower (EF)	40	55	70	mV
		tuned LC circuit to V _{CC} and EF	400	550	700	mV
H ₂	second harmonic distortion	tuned LC circuit (Q > 20) and EF	-	-	-30	dB
f_{H/2} output; coupled to burst sequence (pin 27)						
V _{O(L)}	LOW level DC output voltage	burst phase = +135°	-	-	0.5	V
V _{O(H)}	HIGH level DC output voltage	burst phase = -135°	4.5	-	-	V
V _{NTSC4.43}	input level for forced NTSC 4.43 mode (no NAP)	NTSC; playback mode	-	-	1.5	V
Chrominance output to tape (pin 28); see Table 2						
V ₂₈	DC output voltage	colour on	2.1	2.4	2.7	V
		colour killer active	-	0.1	0.3	V
V _{o(p-p)}	chrominance output signal voltage (N × f _H) (peak-to-peak value)	record mode; PAL	467	660	932	mV
G _{UP}	SECAM-f _{OR} burst related to PAL burst	SECAM	0.2	1.0	1.8	dB
H ₂	second harmonic distortion	V ₃₃ = 0 dB	-	-	-40	dB
		V ₃₃ = +6 dB	-	-	-35	dB
H ₃	third harmonic distortion	V ₃₃ = 0 dB	-	-	-40	dB
		V ₃₃ = +6 dB	-	-	-35	dB
α _{CK}	colour killer suppression		40	-	-	dB
Playback chrominance input from tape (pin 30)						
V ₃₀	DC voltage		1.7	2.2	2.7	V
V _{i(p-p)}	input signal voltage (peak-to-peak value)	chrominance + FM	-	-	310	mV
		chrominance	11	110	220	mV

Y/C automatic adjustment processor (VHS standard)

TDA9725

SYMBOL	PARAMETER	CONDITIONS	MIN.	TYP.	MAX.	UNIT
ACC output (pin 32); see Table 5						
V ₃₂	DC output voltage		1.75	2.25	2.75	V
V _{o(p-p)}	controlled output signal voltage (peak-to-peak value)	V _i = 0 dB; record mode	370	460	550	mV
		V _i = 0 dB; playback mode; PAL; -15 dB comb filter	350	440	530	mV
ΔG _o	deviation of output signal	V _i = -15 dB/+6 dB; record and playback modes	-1.0	-	+1.0	dB
H ₂	second harmonic distortion	nominal input and output signal	-	-	-40	dB
H ₃	third harmonic distortion	nominal input and output signal	-	-	-40	dB
Balanced mixer input (pin 33)						
V ₃₃	DC voltage		1.6	1.9	2.2	V
V _{i(p-p)}	nominal input signal voltage (peak-to-peak value)		-	440	-	mV
Switch SECAM/NTSC/PAL (pin 34)						
R _i	internal resistance to ground		40	50	60	kΩ
V _i	input voltage	active SECAM mode	3.5	-	5	V
		active NTSC mode	1.75	-	3	V
		active PAL mode	0	-	1.25	V
Comb driver output (pin 35); see Tables 3, 4 and 10						
V ₃₅	DC output voltage	record and playback modes	2.0	2.5	3.0	V
V _{o(p-p)}	output signal voltage (peak-to-peak value)	playback mode; NTSC; -10 dB comb filter	304	380	456	mV
		playback mode; PAL/SECAM; -15 dB comb filter	540	675	810	mV
H ₂	second harmonic distortion	playback mode; 0 dB	-	-	-40	dB
H ₃	third harmonic distortion	playback mode; 0 dB	-	-	-40	dB
ΔG _{BD(S)}	burst down	playback mode; NTSC; SP	-6.0	-5.0	-4.0	dB
ΔG _{BD(E)}	burst down	playback mode; NTSC; EP	-5.0	-4.0	-3.0	dB
G _{SECid}	gain of output signal for SECAM identification	record mode (ACC is not active) from pin 43	-	3.0	-	dB
Chrominance input from comb filter (pin 36)						
V _{GL}	DC voltage for glass comb	AC coupled	3.2	4.0	4.8	V
V _{CCD}	DC voltage for CCD comb	DC coupled	0	-	1.5	V
V _{i(p-p)}	input signal voltage (peak-to-peak value)	PAL; NTSC	-	120	-	mV

Y/C automatic adjustment processor (VHS standard)

TDA9725

SYMBOL	PARAMETER	CONDITIONS	MIN.	TYP.	MAX.	UNIT
Playback chrominance output (pin 38; sync blanking is always active); see Table 6						
V ₃₈	DC output voltage		1.1	1.6	2.1	V
V _{o(p-p)}	output signal voltage (peak-to-peak value)	V ₃₀ = 110 mV (p-p)	270	325	420	mV
H ₂	second harmonic distortion	V ₃₀ = 110 mV (p-p)	–	–	–40	dB
α _{CK}	colour killer/pilot burst suppression	colour killer or sync blanking interval	40	–	–	dB
ΔV _{C*}	output amplitude deviation	C to C*; V ₃₆ = 120 mV (p-p)	–1.5	0	+1.5	dB
Δφ _{C*}	output phase deviation	C to C* or NAP line n to n + 1	–15	0	+15	°
Δφ _{NAP}	phase for NAP burst	NAP burst to –(B – Y) axis	±30	±45	±60	°
α _{2f_{sc}}	2f _{sc} suppression	C*; V ₃₆ = 120 mV (p-p)	35	–	–	dB
α _{3f_{sc}}	3f _{sc} suppression	C*; V ₃₆ = 120 mV (p-p)	18	25	–	dB
Playback chrominance input (pin 39)						
V ₃₉	DC voltage		1.7	2.0	2.3	V
V _{i(p-p)}	input voltage (peak-to-peak value)		–	325	–	mV
V _{th}	threshold level of AGCKP1 (no reaction on copy guard)	record mode	2.6	3.0	3.4	V
CVBS output (pin 41); see Table 7						
V ₄₁	DC output voltage	sync tip; R _L = 2.1 kΩ	0.9	1.05	1.2	V
RECORD MODE						
V _{oREC(p-p)}	record output voltage (standard output level) (peak-to-peak value)	video/sync = 7/3; R _L = 2.1 kΩ	2.03	2.14	2.25	V
ΔV _{oREC(p-p)}	record output voltage level stability (peak-to-peak value)	ΔV _{CC} = ±0.25 V or T _{amb} = –10 to +70 °C	–40	–	+40	mV
V _{o(p-p)}	compressed sync output voltage (200 IRE) (peak-to-peak value)	video/sync = 7.0/1.5	2.13	2.32	2.52	V
G _{CON}	control characteristic of AGC	V ₄₃ = 0.5 to 2.0 V (p-p)	0	0.2	1.0	dB
ΔV _{CG}	VHS standard (signal amplitude for copy guard tapes)	100% = typical output level; copy guard 7 lines/field	35	–	48	%

Y/C automatic adjustment processor (VHS standard)

TDA9725

SYMBOL	PARAMETER	CONDITIONS	MIN.	TYP.	MAX.	UNIT
PLAYBACK MODE						
$V_{oPB(p-p)}$	playback output voltage (peak-to-peak value)	video/sync = 7/3; nominal FM signal; $R_L = 2.1 \text{ k}\Omega$; test: EE without ME, MDE, peaking, YNR	2.03	2.14	2.25	V
$\Delta V_{oPB(p-p)}$	playback output voltage level stability (peak-to-peak value)	$\Delta V_{CC} = \pm 0.25 \text{ V}$ or $T_{amb} = -10 \text{ to } +70 \text{ }^\circ\text{C}$	-40	-	+40	mV
V_{NC}	white noise clip level	black-to-white = 100%; TRICK	115	135	150	%
ΔV_{os}	offset voltage between DOC mode and normal mode		-25	-	+25	mV
α_{ct}	DOC switch crosstalk	0 dB = 2.0 V (p-p); $f_i = 1 \text{ MHz}$	-	-	-40	dB
t_{att}	attack time of switching to DOC mode from normal mode		-	0.7	1.0	μs
t_{rec}	recovery time of switching to normal mode from DOC mode		4.0	5.0	6.0	μs
$V_{o(p-p)}$	chrominance output voltage (peak-to-peak value)	$V_{30} = 110 \text{ mV (p-p)}$	1.0	1.2	1.4	V
ΔG_{CHROM}	chrominance frequency response	$V_i = V_{39}$; $f_i = 5 \text{ to } 1 \text{ MHz}$	-2	-	+2	dB
VERTICAL SYNCHRONIZATION PULSE/CHARACTER INSERT (RECORD AND PLAYBACK MODES)						
ΔV_{ST}	artificial sync tip level voltage offset	$V_{42} = 0 \text{ to } 5 \text{ V}$; playback mode	-50	0	+50	mV
$\Delta V_{bl(p-p)}$	artificial black level voltage (peak-to-peak value)	$V_{42} = 5 \text{ to } 3 \text{ V}$	0.58	0.68	0.78	V
$\Delta V_{wh(p-p)}$	artificial white level voltage (peak-to-peak value)	$V_{42} = 5 \text{ to } 2 \text{ V}$	1.7	1.9	2.05	V
α_{VIDEO}	suppression of video at character insert		40	-	-	dB
NON-LINEAR DE-EMPHASIS (PLAYBACK MODE); note 7						
S1	response S1	-20 dB; $f_i = 500 \text{ kHz}$; SP	-2.9	-1.9	-0.9	dB
S2	response S2	-20 dB; $f_i = 2 \text{ MHz}$; SP	-6.5	-5.0	-3.5	dB
L1	response L1	-20 dB; $f_i = 500 \text{ kHz}$; LP	-6.5	-4.8	-3.0	dB
L2	response L2	-20 dB; $f_i = 2 \text{ MHz}$; LP	-10.2	-8.4	-6.7	dB
L3	response L3	0 dB; $f_i = 2 \text{ MHz}$; LP	-4.8	-3.2	-1.8	dB
NOISE CANCELLER (PLAYBACK MODE); note 8						
NC1	response NC1	-30 dB; $f_i = 1 \text{ MHz}$; NORMAL	-5.5	-3.5	-1.4	dB
NC2	response NC2	-30 dB; $f_i = 2 \text{ MHz}$; NORMAL	-15.0	-11.6	-8.0	dB
NC4	response NC4	0 dB; $f_i = 2 \text{ MHz}$; NORMAL	-1.3	-0.3	+0.7	dB
NCED	response NCEDIT	-30 dB; $f_i = 2 \text{ MHz}$; EDIT	-5.0	-3.4	-1.8	dB

Y/C automatic adjustment processor (VHS standard)

TDA9725

SYMBOL	PARAMETER	CONDITIONS	MIN.	TYP.	MAX.	UNIT
LINE NOISE CANCELLER (YNR WEAK; PLAYBACK MODE); note 9						
LNC1	depth 1	-30 dB non-recursive	-7.0	-5.5	-4.5	dB
LNC2	depth 2	-20 dB non-recursive	-4.3	-3.3	-2.3	dB
LNC3	depth 3	0 dB non-recursive	-1.0	-0.2	0	dB
VERTICAL NOISE CANCELLER (YNR STRONG; PLAYBACK MODE); note 9						
VNC1	depth 1	-30 dB recursive	-10.0	-8.5	-7.5	dB
VNC2	depth 2	-20 dB recursive	-9.0	-7.5	-6.5	dB
VNC3	depth 3	0 dB recursive	-1.8	-0.4	0	dB
PICTURE CONTROL; (note 10)						
PC1	response 1 (sharp)	$V_1 = 0 \text{ V}$; $f_i = 0.5 \text{ MHz}$	0	0.5	1.0	dB
PC2	response 2 (sharp)	$V_1 = 0 \text{ V}$; $f_i = 2 \text{ MHz}$	3.7	4.7	5.7	dB
PC3	response 3 (soft)	$V_1 = 3.2 \text{ V}$; $f_i = 0.5 \text{ MHz}$	-2.3	-1.3	-0.8	dB
PC4	response 4 (soft)	$V_1 = 3.2 \text{ V}$; $f_i = 2 \text{ MHz}$	-6.8	-5.8	-4.8	dB
PC5	response 5 (centre)	pin 1 open-circuit or $> 4.1 \text{ V}$; $f_i = 2 \text{ MHz}$	-0.5	+0.0	+0.5	dB
t_d	delay time	pin 1 open-circuit; $f_i = 0.1 \text{ MHz}$	185	210	235	ns
Character insert (artificial sync/black/white/through; pin 42)						
R_i	internal resistance to ground	$V_{42} = 0 \text{ to } 1.0 \text{ V}$	40	50	60	$k\Omega$
V_{AS}	input voltage for artificial sync (inserts sync level)		4.0	-	5.0	V
V_{AB}	input voltage for artificial black (inserts black level)		2.75	-	3.5	V
V_{AW}	input voltage for artificial white (inserts white level)		1.5	-	2.25	V
V_{THR}	input voltage for through mode		0	-	1.0	V
CVBS input (pin 43)						
V_{43}	DC voltage		2.35	2.75	3.15	V
$V_{i(p-p)}$	CVBS input voltage (peak-to-peak value)		0.3	1.0	2.0	V
AGC detector (pin 44)						
V_{44}	detector voltage	$V_{43} = 1 \text{ V (p-p)}$	1.8	2.5	3.2	V

Y/C automatic adjustment processor (VHS standard)

TDA9725

SYMBOL	PARAMETER	CONDITIONS	MIN.	TYP.	MAX.	UNIT
Sync separator push-pull output (pin 45)						
$V_{O(H)}$	HIGH level output voltage	$R_L = 2 \text{ k}\Omega$ to ground	4.5	–	–	V
$V_{O(L)}$	LOW level output voltage	$R_L = 10 \text{ k}\Omega$ to V_{CC}	–	–	0.3	V
t_{dFE}	front edge delay time	referenced to sync start pin 48; note 11	600	750	900	ns
t_{dBE}	back edge delay time	referenced to sync end pin 48; note 11	100	350	600	ns
Φ_{sync}	input sensitivity (slicing level for sync)	sync-to-black = 100%	26	33	40	%
Sync separator detector (pin 46)						
V_{46}	detector voltage		2.3	–	3.3	V
YNR switch (pin 47); see Table 11						
R_I	internal resistance to ground		40	50	60	$\text{k}\Omega$
V_{47}	input voltage	YNR off mode	3.5	–	5.0	V
		YNR1 mode	1.75	–	3.0	V
		YNR2 mode	0	–	1.25	V
Video input from 1HDL CCD (pin 48)						
V_{48}	DC voltage		1.5	1.9	2.3	V
$V_{i(p-p)}$	input voltage for constant output signal at pin 49 (peak-to-peak value)		178	283	449	mV
Video output to 1HDL CCD (pin 49)						
V_{oST}	sync tip output voltage		0.9	1.4	1.9	V
$V_{o(p-p)}$	output voltage (peak-to-peak value)	CCD with –3 dB (record mode)	380	420	460	mV
Storage capacitor for CCD level AGC (pin 50)						
V_{50}	DC voltage		1.4	2.1	2.8	V
G_{CCD}	CCD gain control range		0	3	6	dB
Low-pass filter input for noise canceller (pin 52)						
V_{52}	DC voltage		1.0	1.2	1.4	V

**Y/C automatic adjustment processor
(VHS standard)**

TDA9725**Notes to the characteristics**

1. 50 Hz; rotary transition 8 to 4 lines beyond vertical pulse.
2. Test mode; YNR off; main emphasis off; $V_{50} = 1.5$ V (minimum gain).
3. Input: $V_{48} = 143$ mV sync and $0 \text{ dB} = V_{48} = 333$ mV picture. Output: $0 \text{ dB} = V_5$ picture at ≤ 50 kHz and given input level.
4. Input: $V_{43} = 300$ mV sync and $0 \text{ dB} = V_{43} = 700$ mV picture. Output: $0 \text{ dB} = V_5$ picture at 1, 2 and $3 \times f_H$ and given input level.
5. Burst gate pulse output with no external components; sandcastle output with $10 \text{ k}\Omega$ resistor to V_{CC} .
6. Crystal characteristics: TEW 8H:
 $f_{\text{nom}} = 4.433619 \text{ MHz} \pm 15 \times 10^{-6}$; $R_S \leq 90 \text{ }\Omega$; $C_1 = 11 \text{ fF}$; $L_1 = 117.14791 \text{ mH}$; $C_0 = 2.6 \text{ pF}$.
7. Input: $V_8 = 90$ mV sync and $0 \text{ dB} = V_8 = 210$ mV picture. Output: $0 \text{ dB} = V_{41}$ at ≤ 50 kHz and given input level. Noise canceller off; picture control centre; YNR off; measured with YLPF.
8. Input: $V_8 = 90$ mV sync and $0 \text{ dB} = V_8 = 210$ mV picture. Output: $0 \text{ dB} = V_{41}$ at 100 kHz and given input level. Picture control centre; NLDE off; YNR off. Pin 52: $R = 1.3 \text{ k}\Omega$; $C = 47 \text{ nF}$ (parasitic capacitance: 5 pF from pin 52 to GND).
9. Input: $V_8 = 90$ mV sync and $0 \text{ dB} = V_8 = 210$ mV picture. Output: $0 \text{ dB} = V_{41}$ at 1, 2 and $3 \times f_H$ and given input level. Picture control at centre; NC off; NLDE off.
10. Input: $V_8 = 90$ mV sync and $V_8 = 67$ mV picture. Output: $0 \text{ dB} = V_{41}$ at 100 kHz referring to YNRMIX signal at pin 3 of the same frequency. Noise canceller off; YNR off; NLDE off.
11. Input: $V_{48} = 143$ mV sync; $V_{50} = 1.5$ V; dropout or test mode forced DOC.

Y/C automatic adjustment processor (VHS standard)

TDA9725

CHROMINANCE FILTER CHARACTERISTICS

Table 2 Low-pass filter 630 kHz; frequency response pin 33 to pin 28

SYMBOL	PARAMETER	CONDITIONS	MIN.	TYP.	MAX.	UNIT
PAL; NTSC/REC						
$\Delta G1$	frequency response 1	G(1 MHz)/G(0.2 MHz)	-4	-3	-2	dB
$\Delta G2$	frequency response 2	G(1.5 MHz)/G(0.2 MHz)	-9	-7	-5	dB
$\Delta G3$	frequency response 3	G(2 MHz)/G(0.2 MHz)	-10	-14	-18	dB
$\Delta G4$	frequency response 4	G(3 MHz)/G(0.2 MHz)	-	-	-25	dB
$\Delta G5$	frequency response 5	G(4.43 MHz)/G(0.2 MHz)	-	-	-40	dB
$\Delta G7$	frequency response 7	G(9.5 MHz)/G(0.2 MHz)	-	-	-35	dB
t_d	group delay 1	$f_i = 0.63$ MHz	295	335	375	ns
SECAM; REC						
$\Delta G2$	frequency response (2)	G(1.5 MHz)/G(0.2 MHz)	-5	-3	-1	dB

Table 3 Band-pass filter 4.43 MHz at record mode; frequency response pin 43 to pin 35

SYMBOL	PARAMETER	CONDITIONS	MIN.	TYP.	MAX.	UNIT
PAL; NTSC/REC						
$\Delta G1$	frequency response 1	G(<2.7 MHz)/G(4.43 MHz)	-	-	-22	dB
$\Delta G2$	frequency response 2	G(2.7 MHz)/G(4.43 MHz)	-	-	-30	dB
$\Delta G3$	frequency response 3	G(3.93 MHz)/G(4.43 MHz)	-3.8	-2.8	-1.8	dB
$\Delta G4$	frequency response 4	G(4.93 MHz)/G(4.43 MHz)	-2.5	-1.5	-0.5	dB
$\Delta G5$	frequency response 5	G(6.2 MHz)/G(4.43 MHz)	-	-	-30	dB
$\Delta G6$	frequency response 6	G(>6.2 MHz)/G(4.43 MHz)	-	-	-15	dB
t_d	group delay 1	$f_i = 4.43$ MHz	410	450	490	ns
SECAM; REC						
$\Delta G7$	frequency response 7	G(5.7 MHz)/G(4.43 MHz)	-	-	-25	dB

Y/C automatic adjustment processor (VHS standard)

TDA9725

Table 4 Band-pass filter 4.43 MHz at playback mode; frequency response pin 33 to pin 35 (test mode)

SYMBOL	PARAMETER	CONDITIONS	MIN.	TYP.	MAX.	UNIT
PAL; NTSC/PB						
ΔG_1	frequency response 1	G(<2.7 MHz)/G(4.43 MHz)	–	–	–20	dB
ΔG_2	frequency response 2	G(2.9 MHz)/G(4.43 MHz)	–	–	–30	dB
ΔG_3	frequency response 3	G(3.93 MHz)/G(4.43 MHz)	–3.7	–2.7	–1.7	dB
ΔG_4	frequency response 4	G(4.93 MHz)/G(4.43 MHz)	–3.9	–2.9	–1.9	dB
ΔG_5	frequency response 5	G(5.7 MHz)/G(4.43 MHz)	–	–30	–25	dB
ΔG_6	frequency response 6	G(6 MHz)/G(4.43 MHz)	–	–	–22	dB
ΔG_7	frequency response 7	G(>6 MHz)/G(4.43 MHz)	–	–	–15	dB
t_d	group delay 1	$f_i = 4.43$ MHz	445	485	525	ns
SECAM; PB						
ΔG_8	frequency response 8	G(1.9 MHz)/G(4.43 MHz)	–	–30	–22	dB
ΔG_9	frequency response 9	G(5.5 MHz)/G(4.43 MHz)	–	–30	–22	dB

Table 5 Band-pass filter 630 kHz; frequency response pin 30 to pin 32 (test mode)

SYMBOL	PARAMETER	CONDITIONS	MIN.	TYP.	MAX.	UNIT
PB						
ΔG_1	frequency response 1	G(<100 Hz)/G(630 kHz)	–	–	–20	dB
ΔG_2	frequency response 2	G(100 kHz)/G(630 kHz)	–7	–5	–3	dB
ΔG_3	frequency response 3	G(930 kHz)/G(630 kHz)	–3	–2	–1	dB
ΔG_4	frequency response 4	G(1.5 MHz)/G(630 kHz)	–	–15	–10	dB
ΔG_5	frequency response 5	G(2.3 MHz)/G(630 kHz)	–	–	–40	dB
ΔG_6	frequency response 6	G(>2.4 MHz)/G(630 kHz)	–	–	–33	dB
t_d	group delay 1	$f_i = 630$ kHz; pin 36 normal	710	750	790	ns
Δt_d	group delay 4 difference	$V_{36} = 4$ to 1 V	–250	–210	–170	ns

Table 6 Low-pass filter C*; frequency response pin 36 to pin 38

SYMBOL	PARAMETER	CONDITIONS	MIN.	TYP.	MAX.	UNIT
PB; C						
ΔG_1	frequency response 1	G(5 MHz)/G(2 MHz)	0	–1.5	–3	dB
ΔG_2	frequency response 2	G(13.3 MHz)/G(2 MHz)	–18	–25	–	dB
ΔG_3	frequency response 3	G(>13.3 MHz)/G(2 MHz)	–18	–	–	dB
t_d	group delay 1	$f_i = 4.43$ MHz	65	95	125	ns

Y/C automatic adjustment processor (VHS standard)

TDA9725

LUMINANCE FILTER CHARACTERISTICS

Table 7 Low-pass filter 4.43 MHz; frequency response pin 43 to pin 3 (test mode)

SYMBOL	PARAMETER	CONDITIONS	MIN.	TYP.	MAX.	UNIT
REC						
$\Delta G1$	frequency response 1	G(2 MHz)/G(0.2 MHz)	-1.0	+0.5	+1.5	dB
$\Delta G2$	frequency response 2	G(3 MHz)/G(0.2 MHz)	-2.5	-1.0	+0.5	dB
$\Delta G3$	frequency response 3	G(4.43 MHz)/G(0.2 MHz)	-	-40	-30	dB
t_d	group delay 1	$f_i = 0.2$ MHz	710	750	790	ns

Table 8 Sub-low-pass filter; frequency response from FM demodulator to pin 9

SYMBOL	PARAMETER	CONDITIONS	MIN.	TYP.	MAX.	UNIT
$\Delta G1$	frequency response 1	G(3 MHz)/G(0.2 MHz)	-4.5	-2	0	dB
$\Delta G2$	frequency response 2	G(6 MHz)/G(0.2 MHz)	-	-25	-15	dB

Sensitivity

Table 9 Sensitivity of PB APC (multiplication factor for phase detector sensitivity)

PROGRAM	PAL		NTSC/NAP			NTSC4.4		
	SP	LP	SP	LP	EP	SP	LP	EP
NORM	2	1 ⁽²⁾	2 ⁽¹⁾⁽²⁾	2 ⁽¹⁾⁽²⁾	2 ⁽¹⁾⁽²⁾	4 ⁽¹⁾	2 ⁽¹⁾⁽²⁾	2 ⁽¹⁾⁽²⁾
TRICK	2	1 ⁽¹⁾⁽²⁾	2 ⁽¹⁾⁽²⁾	2 ⁽¹⁾⁽²⁾	2 ⁽¹⁾⁽²⁾	2 ⁽¹⁾⁽²⁾	2 ⁽¹⁾⁽²⁾	2 ⁽¹⁾⁽²⁾

Notes

1. No alternating reference for APC loop.
2. Comb filter is inside the APC loop.

Burst down logic

Table 10 Burst down logic

MODE	SYSTEM		BURST DOWN
Playback	NTSC	SP	ON (-5.0 dB)
		LP	OFF
		EP	ON (-4.0 dB)
	PAL		OFF
	SECAM		OFF

Y/C automatic adjustment processor (VHS standard)

TDA9725

OPERATION MODE

Table 11 Operation mode (PART 1)

For PAL RECORD, SECAM ME RECORD, PAL PLAYBACK, SECAM ME PLAYBACK and NTSC PLAYBACK.
EP mode at NTSC PLAYBACK activates the same functions as LP mode.

FILTER	MODE	CONDITIONS	EDIT OFF		EDIT ON	
			SP	LP	SP	LP
YNR	REC	YNR off; pin 47 HIGH	OFF		OFF	
		YNR 1; pin 47 medium	OFF		OFF	
		YNR 2; pin 47 LOW	OFF	vertical emphasis	OFF	
	PB	YNR off; pin 47 HIGH	OFF		OFF	
		YNR 1; pin 47 medium	VNC (strong)	LNC (weak)	OFF	
		YNR 2; pin 47 LOW	LNC (weak)	VNC (strong)	OFF	LNC (weak)
NLE NLDE	REC	YNR off; pin 47 HIGH	NLE(C) + DTE	NLE(D)	NLE(C)	NLE(D)
		YNR 1; pin 47 medium				
		YNR 2; pin 47 LOW				
	PB	NLDE(C)	NLDE(D)	NLDE(C)	NLDE(D)	
Noise canceller	PB	ON		WEAK		
Picture control	PB	ON		OFF		
FM carrier interleave			ON		ON	

Table 12 Operation mode (PART 2)

FUNCTION	CONDITIONS		OPERATION
Clamps	REC		ON
	PB	NORM	OFF
dropout; maximum 128 lines			
Character insert	REC or PB	VIDEO; pin 42 LOW	through
		WHITE; pin 42 = M1	white level (85%)
		BLACK; pin 42 = M2	black level
		SYNC; pin 42 HIGH	sync tip level
Search noise clip	REC		OFF
	PB	NORM	ON
TRICK			
SQPB	PB	VHS; pin 5 open-circuit	VHS
		SQPB; pin 5 HIGH	SQPB

Y/C automatic adjustment processor
(VHS standard)

TDA9725

Automatic chrominance control (ACC) characteristics

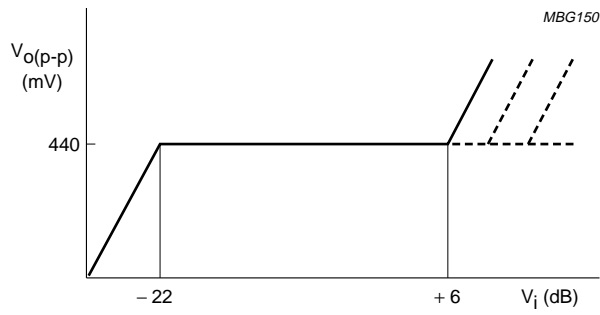

0 dB is equivalent to 110 mv (p-p) at pin 30.

Fig.4 ACC characteristics.

Y/C automatic adjustment processor
(VHS standard)

TDA9725

INTERNAL CIRCUITRY
Table 13 Internal circuitry of Figs 1 and 2

PIN NO.	PIN NAME (DESCRIPTION)	DC (V)	WAVEFORM		INTERNAL CIRCUIT
			EE	WV	
1	picture control/EDIT switch	1.6	4.1 V to 5.0 V EDIT	0 V to 1.6 V sharp 1.6 V to 3.2 V soft 4.1 V to 5.0 V EDIT	
2	deviation/playback AGC detector	2.5			

Y/C automatic adjustment processor
(VHS standard)

TDA9725

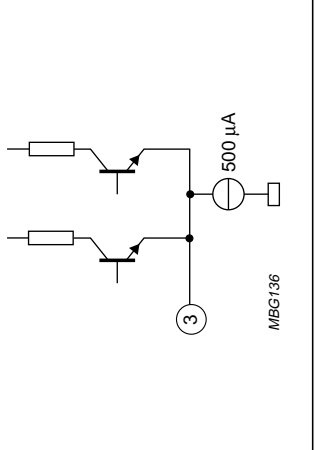
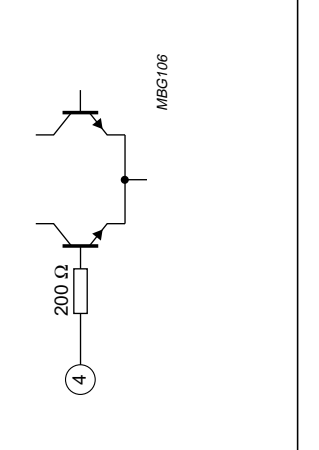
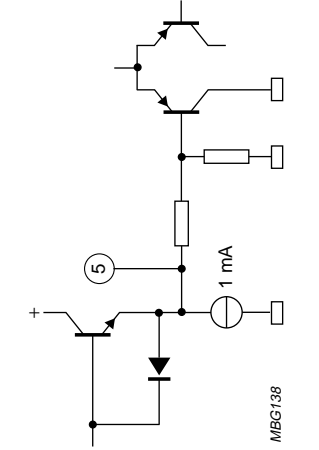
PIN NO.	PIN NAME (DESCRIPTION)	DC (V)	WAVEFORM		INTERNAL CIRCUIT	Z
			EE	WV		
3	test pin 2/ correlation detector output		2.1 V = COR	0 V = non-COR		$V_T / 500 \mu A$
4	negative feedback input of main emphasis		1.9 V (sync) 500 mV sync-white	0 V		open base
5	main emphasis output/white clip/ modulator input/ SQPB selector		1.9 V (sync) 500 mV sync-white	0 V		$V_T / 1 \text{ mA}$

Y/C automatic adjustment processor
(VHS standard)

TDA9725

PIN NO.	PIN NAME (DESCRIPTION)	DC (V)	WAVEFORM		Z	INTERNAL CIRCUIT
			EE	WW		
6	capacitor for clamp 3				V_T/I_E	<p>MBG144</p>
7	storage capacitor for f_0 processor (REC)/ envelope detector (PB)	1.2 V	3.3 V			<p>MBG143</p>
8	main de-emphasis output	5 V	3.4 V (sync) 300 mV sync-white	<p>MBG159</p>	open collector	<p>MBG135</p>

Y/C automatic adjustment processor
(VHS standard)

TDA9725

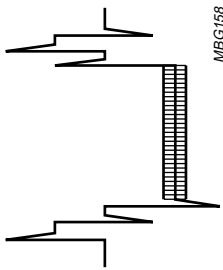
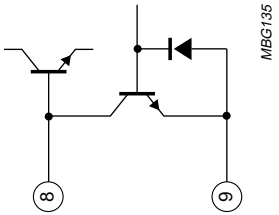
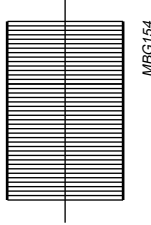
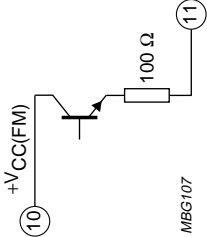
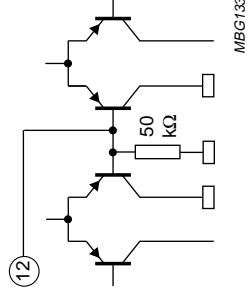
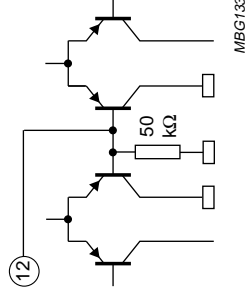
PIN NO.	PIN NAME (DESCRIPTION)	DC (V)	WAVEFORM		Z	INTERNAL CIRCUIT
			EE	WV		
9	main de-emphasis and peaking		0 V		V_T/I_E	
10	supply voltage for FM parts	5.0				
11	FM output		3.2 V 0.9 V (p-p) rectangle		$V_T/I_E + 100 \Omega$	
12	switch (PB/TRICK/REC)		0 V to 1.25 V REC		50 k Ω	

Y/C automatic adjustment processor
(VHS standard)

TDA9725

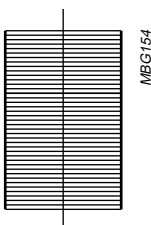
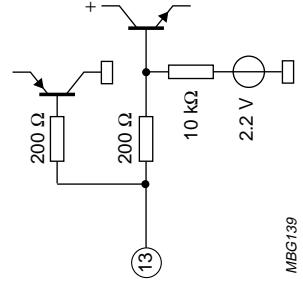
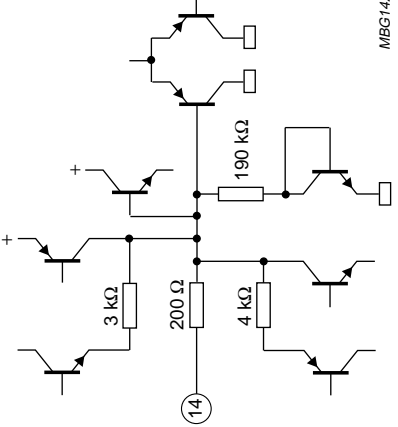
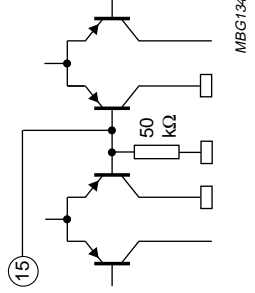
PIN NO.	PIN NAME (DESCRIPTION)	DC (V)	WAVEFORM		INTERNAL CIRCUIT	Z
			EE	VW		
13	PB FM input		1.6 V	2.2 V 200 mV (p-p) sinusoidal (350 mV (p-p) if FM AGC off)  MBG154	 MBG139	10 kΩ
14	storage capacitor for FM AGC			3.1 V 4.3 V to 5.0 V FM AGC off	 MBG142	
15	switch (LPC*/LP/SP) at PAL switch (EP/LP/SP) at NTSC	0	0 V to 1.25 V SP 1.75 V to 3.0 V LP 3.5 V to 5.0 V LPC* (PAL) 3.5 V to 5.0 V EP (NTSC)		 MBG134	50 kΩ

Y/C automatic adjustment processor
(VHS standard)

TDA9725

PIN NO.	PIN NAME (DESCRIPTION)	DC (V)	WAVEFORM		Z	INTERNAL CIRCUIT
			EE	WV		
16	colour killer terminal	2.8				<p>MBG141</p>
17	frequency correction output	2.1				<p>MBG137</p>
18	BGP output (HIGH active)		<p>(a) open circuit</p>	<p>(b) with 10 kΩ resistor to V_{CC}</p>		<p>MBG132</p>

Y/C automatic adjustment processor
(VHS standard)

TDA9725

PIN NO.	PIN NAME (DESCRIPTION)	DC (V)	WAVEFORM		Z	INTERNAL CIRCUIT
			EE	WV		
19	rotary pulse		0 V to 2.25 V CH2 2.75 V to 5 V CH1		open base	<p>MBG131</p>
20	loop filter (REC) VXO	2.4				<p>MBG130</p>
21	loop filter VCO	2.1				<p>MBG129</p>
22	not connected				HIGH	

Y/C automatic adjustment processor
(VHS standard)

TDA9725

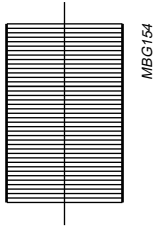
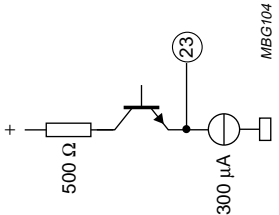
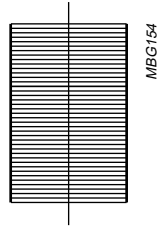
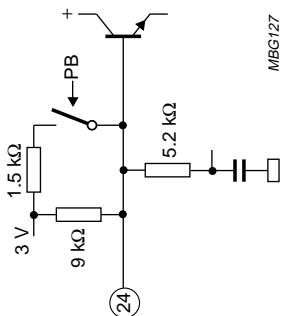
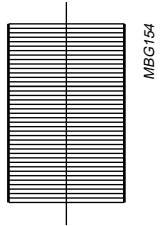
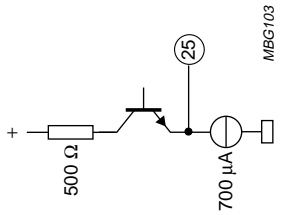
PIN NO.	PIN NAME (DESCRIPTION)	DC (V)	WAVEFORM		INTERNAL CIRCUIT	Z
			EE	VV		
23	f _{sc} output	2.3	600 mV (p-p)			V _T / 300 μA
24	VXO input from crystal	3.0	250 mV (p-p)			9 kΩ/ 1.3 kΩ
25	VXO output to crystal	3.3	230 mV (p-p)			V _T / 700 μA

Y/C automatic adjustment processor
(VHS standard)

TDA9725

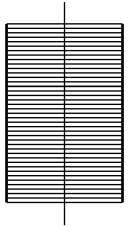
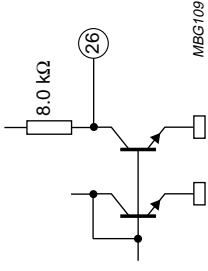
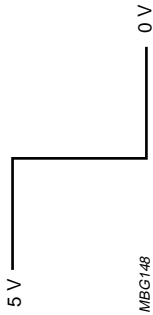
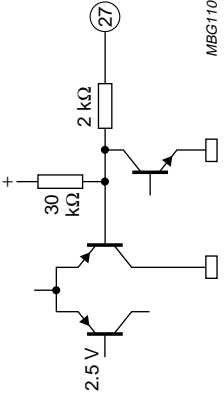
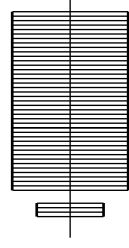
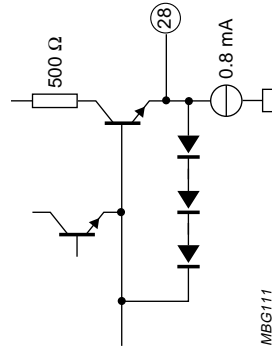
PIN NO.	PIN NAME (DESCRIPTION)	DC (V)	WAVEFORM		Z	INTERNAL CIRCUIT
			EE	WV		
26	$2f_{sc}$ output	4.9	550 mV (p-p)	 <p>MBG154</p>		 <p>8.0 kΩ</p> <p>26</p> <p>MBG109</p>
27	$f_{H/2}$ output (coupled to burst sequence) NAP/NTSC4.43 switch		<p>PB + REC PB: forced 0 V: NTSC4.43 mode</p>  <p>5 V</p> <p>0 V</p> <p>MBG148</p>			 <p>30 kΩ</p> <p>2.5 V</p> <p>27</p> <p>2 kΩ</p> <p>MBG110</p>
28	chrominance output to tape	2.4	660 mV (p-p)	 <p>MBG153</p>	<p>V_T 0.8 mA</p>	 <p>500 Ω</p> <p>28</p> <p>0.8 mA</p> <p>MBG111</p>
29	supply voltage chrominance	5.0				

Y/C automatic adjustment processor
(VHS standard)

TDA9725

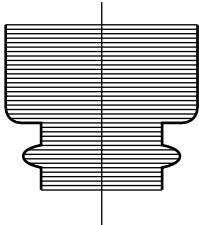
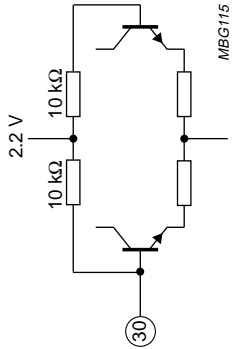
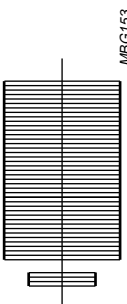
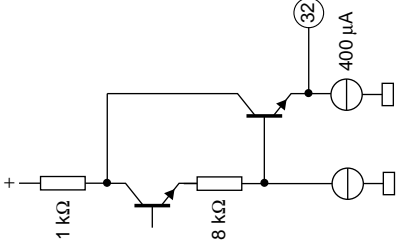
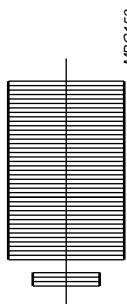
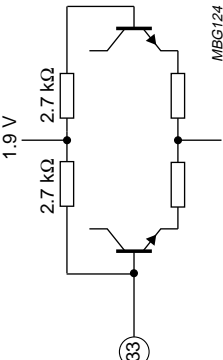
PIN NO.	PIN NAME (DESCRIPTION)	DC (V)	WAVEFORM		INTERNAL CIRCUIT	Z
			EE	VV		
30	PB chrominance input from tape	2.2		chrominance 110 mV (p-p) and FM 		10 kΩ
31	ground	0				
32	ACC output	2.25	440 mV (p-p)			$V_T / 400 \mu A$
33	balanced mixer input	1.9	440 mV (p-p)			2.7 kΩ

Y/C automatic adjustment processor
(VHS standard)

TDA9725

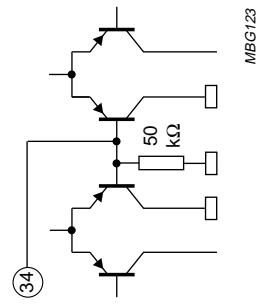
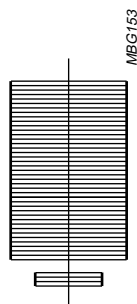
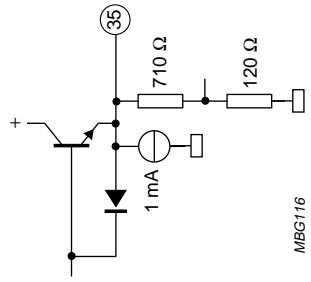
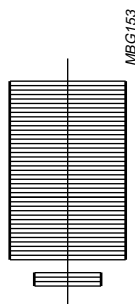
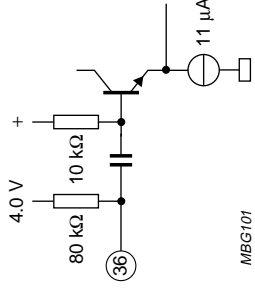
PIN NO.	PIN NAME (DESCRIPTION)	DC (V)	WAVEFORM		INTERNAL CIRCUIT	Z
			EE	VW		
34	switch SECAM/NTSC/PAL	0	0 V to 1.25 V PAL 1.75 V to 3.0 V NTSC 3.5 V to 5.0 V SECAM		 MBG123	50 kΩ
35	comb driver output	2.5	PAL and glass: 675 mV (p-p) NTSC or CCD: 380 mV (p-p)	 MBG153	 MBG116	$V_T/1 \text{ mA}$
36	chrominance input from comb filter	4.0	120 mV (p-p) 4.0 V: glass comb <1.5 V: CCD comb	 MBG153	 MBG101	80 kΩ/ 9 kΩ

Y/C automatic adjustment processor
(VHS standard)

TDA9725

PIN NO.	PIN NAME (DESCRIPTION)	DC (V)	WAVEFORM		INTERNAL CIRCUIT	Z
			EE	VW		
37	test pin 1	0				50 kΩ
38	PB chrominance output	1.6		<p>325 mV (p-p)</p>		$V_T / 600 \mu A$
39	PB chrominance input	1.6 (2.0)		<p>>3.4 V: AGCKP1</p>		20 kΩ
40	supply voltage luminance	5.0				

Y/C automatic adjustment processor
(VHS standard)

TDA9725

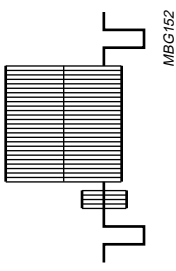
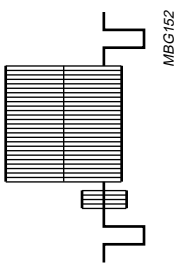
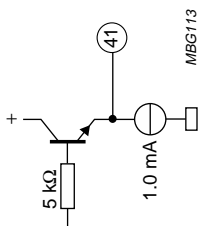
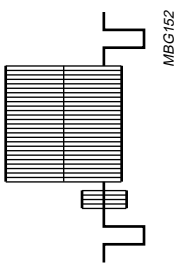
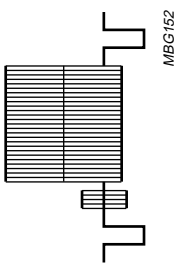
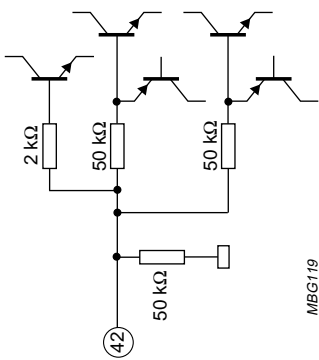
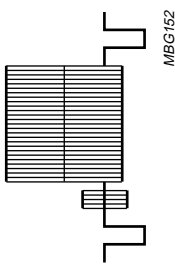
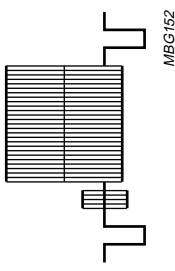
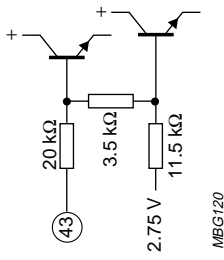
PIN NO.	PIN NAME (DESCRIPTION)	DC (V)	WAVEFORM		INTERNAL CIRCUIT	Z
			EE	VW		
41	video output	1.05 sync	 <p>sync-white: 2.14 V (p-p) chrominance: 1.2 V (p-p)</p>			$V_T/1$ mA
42	character insert (artificial sync/ black/white/ through)	0.0				50 kΩ
43	video input	2.75				

Y/C automatic adjustment processor
(VHS standard)

TDA9725

PIN NO.	PIN NAME (DESCRIPTION)	DC (V)	WAVEFORM		INTERNAL CIRCUIT	Z
			EE	WW		
44	AGC detector	2.5			<p>MBG121</p>	$V_T/I_E + 100 \Omega$
45	sync separator output		<p>5 V 0 V</p> <p>MBG147</p>		<p>MBG112</p>	
46	sync separator detector	3.1			<p>MBG117</p>	$V_T/I_E + 500 \Omega$

Y/C automatic adjustment processor
(VHS standard)

TDA9725

PIN NO.	PIN NAME (DESCRIPTION)	DC (V)	WAVEFORM		INTERNAL CIRCUIT	Z
			EE	VV		
47	YNR switch	0	<p>0 V to 1.25 V YNR2 1.75 V to 3.0 V YNR1 3.5 V to 5.0 V YNR off</p>		<p>MBG118</p>	50 kΩ
48	video input from 1H CCD	1.9	<p>MBG146</p>		<p>MBG100</p>	40 kΩ
49	video output to 1H CCD	1.4 sync	<p>MBG146</p>		<p>MBG105</p>	V_T 230 μA

Y/C automatic adjustment processor
(VHS standard)

TDA9725

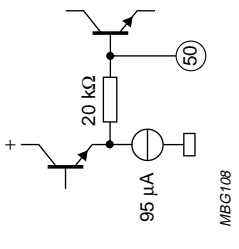
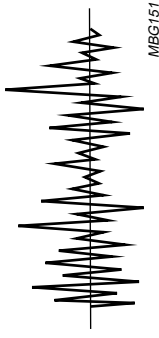
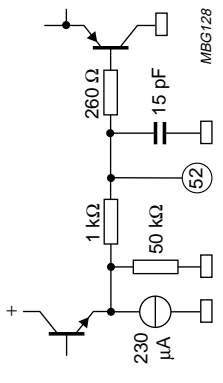
PIN NO.	PIN NAME (DESCRIPTION)	DC (V)	WAVEFORM		INTERNAL CIRCUIT	Z
			EE	WV		
50	storage capacitor for CCD level AGC	2.0				
51	ground luminance	0				
52	low-pass filter for noise canceller	1.2		<p>noise</p> 		1 kΩ

Y/C automatic adjustment processor
(VHS standard)

TDA9725

PACKAGE OUTLINE

SDIP52: plastic shrink dual in-line package; 52 leads (600 mil)

SOT247-1

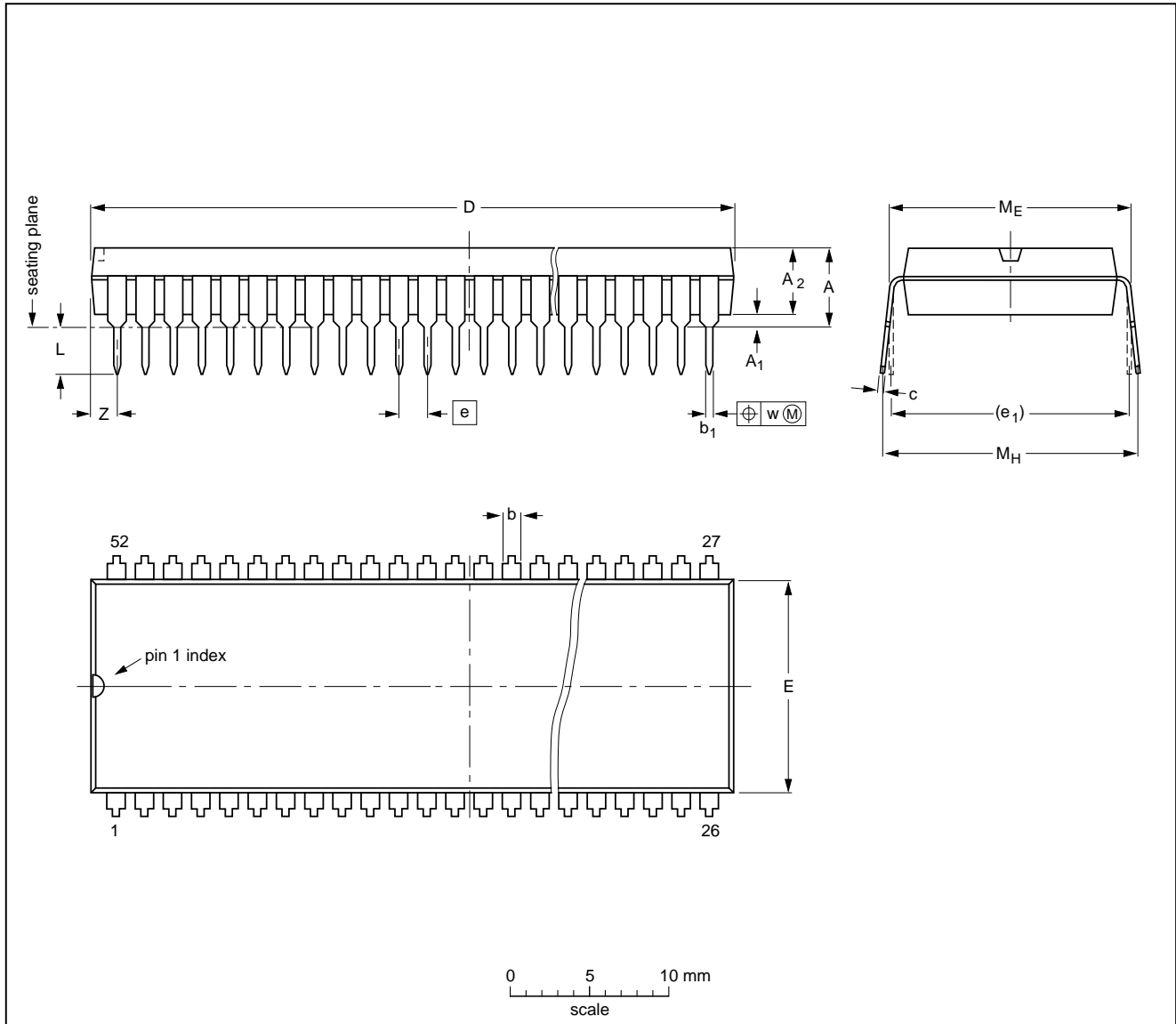

DIMENSIONS (mm are the original dimensions)

UNIT	A max.	A ₁ min.	A ₂ max.	b	b ₁	c	D ⁽¹⁾	E ⁽¹⁾	e	e ₁	L	M _E	M _H	w	z ⁽¹⁾ max.
mm	5.08	0.51	4.0	1.3 0.8	0.53 0.40	0.32 0.23	47.9 47.1	14.0 13.7	1.778	15.24	3.2 2.8	15.80 15.24	17.15 15.90	0.18	1.73

Note

1. Plastic or metal protrusions of 0.25 mm maximum per side are not included.

OUTLINE VERSION	REFERENCES			EUROPEAN PROJECTION	ISSUE DATE
	IEC	JEDEC	EIAJ		
SOT247-1					90-01-22 95-03-11

Y/C automatic adjustment processor (VHS standard)

TDA9725

SOLDERING

Introduction

There is no soldering method that is ideal for all IC packages. Wave soldering is often preferred when through-hole and surface mounted components are mixed on one printed-circuit board. However, wave soldering is not always suitable for surface mounted ICs, or for printed-circuits with high population densities. In these situations reflow soldering is often used.

This text gives a very brief insight to a complex technology. A more in-depth account of soldering ICs can be found in our "IC Package Databook" (order code 9398 652 90011).

Soldering by dipping or by wave

The maximum permissible temperature of the solder is 260 °C; solder at this temperature must not be in contact with the joint for more than 5 seconds. The total contact time of successive solder waves must not exceed 5 seconds.

The device may be mounted up to the seating plane, but the temperature of the plastic body must not exceed the specified storage maximum ($T_{stg\ max}$). If the printed-circuit board has been pre-heated, forced cooling may be necessary immediately after soldering to keep the temperature within the permissible limit.

Repairing soldered joints

Apply a low voltage soldering iron (less than 24 V) to the lead(s) of the package, below the seating plane or not more than 2 mm above it. If the temperature of the soldering iron bit is less than 300 °C it may remain in contact for up to 10 seconds. If the bit temperature is between 300 and 400 °C, contact may be up to 5 seconds.

DEFINITIONS

Data sheet status	
Objective specification	This data sheet contains target or goal specifications for product development.
Preliminary specification	This data sheet contains preliminary data; supplementary data may be published later.
Product specification	This data sheet contains final product specifications.
Limiting values	
Limiting values given are in accordance with the Absolute Maximum Rating System (IEC 134). Stress above one or more of the limiting values may cause permanent damage to the device. These are stress ratings only and operation of the device at these or at any other conditions above those given in the Characteristics sections of the specification is not implied. Exposure to limiting values for extended periods may affect device reliability.	
Application information	
Where application information is given, it is advisory and does not form part of the specification.	

LIFE SUPPORT APPLICATIONS

These products are not designed for use in life support appliances, devices, or systems where malfunction of these products can reasonably be expected to result in personal injury. Philips customers using or selling these products for use in such applications do so at their own risk and agree to fully indemnify Philips for any damages resulting from such improper use or sale.

Philips Semiconductors – a worldwide company

Argentina: see South America

Australia: 34 Waterloo Road, NORTH RYDE, NSW 2113,
Tel. +61 2 9805 4455, Fax. +61 2 9805 4466

Austria: Computerstr. 6, A-1101 WIEN, P.O. Box 213,
Tel. +43 1 60 101, Fax. +43 1 60 101 1210

Belarus: Hotel Minsk Business Center, Bld. 3, r. 1211, Volodarski Str. 6,
220050 MINSK, Tel. +375 172 200 733, Fax. +375 172 200 773

Belgium: see The Netherlands

Brazil: see South America

Bulgaria: Philips Bulgaria Ltd., Energoproject, 15th floor,
51 James Bourchier Blvd., 1407 SOFIA,
Tel. +359 2 689 211, Fax. +359 2 689 102

Canada: PHILIPS SEMICONDUCTORS/COMPONENTS,
Tel. +1 800 234 7381

China/Hong Kong: 501 Hong Kong Industrial Technology Centre,
72 Tat Chee Avenue, Kowloon Tong, HONG KONG,
Tel. +852 2319 7888, Fax. +852 2319 7700

Colombia: see South America

Czech Republic: see Austria

Denmark: Prags Boulevard 80, PB 1919, DK-2300 COPENHAGEN S,
Tel. +45 32 88 2636, Fax. +45 31 57 1949

Finland: Sinikalliontie 3, FIN-02630 ESPOO,
Tel. +358 9 615800, Fax. +358 9 61580/xxx

France: 4 Rue du Port-aux-Vins, BP317, 92156 SURESNES Cedex,
Tel. +33 1 40 99 6161, Fax. +33 1 40 99 6427

Germany: Hammerbrookstraße 69, D-20097 HAMBURG,
Tel. +49 40 23 53 60, Fax. +49 40 23 536 300

Greece: No. 15, 25th March Street, GR 17778 TAVROS/ATHENS,
Tel. +30 1 4894 339/239, Fax. +30 1 4814 240

Hungary: see Austria

India: Philips INDIA Ltd, Shivsagar Estate, A Block, Dr. Annie Besant Rd.
Worli, MUMBAI 400 018, Tel. +91 22 4938 541, Fax. +91 22 4938 722

Indonesia: see Singapore

Ireland: Newstead, Clonskeagh, DUBLIN 14,
Tel. +353 1 7640 000, Fax. +353 1 7640 200

Israel: RAPAC Electronics, 7 Kehilat Saloniki St, TEL AVIV 61180,
Tel. +972 3 645 0444, Fax. +972 3 649 1007

Italy: PHILIPS SEMICONDUCTORS, Piazza IV Novembre 3,
20124 MILANO, Tel. +39 2 6752 2531, Fax. +39 2 6752 2557

Japan: Philips Bldg 13-37, Kohnan 2-chome, Minato-ku, TOKYO 108,
Tel. +81 3 3740 5130, Fax. +81 3 3740 5077

Korea: Philips House, 260-199 Itaewon-dong, Yongsan-ku, SEOUL,
Tel. +82 2 709 1412, Fax. +82 2 709 1415

Malaysia: No. 76 Jalan Universiti, 46200 PETALING JAYA, SELANGOR,
Tel. +60 3 750 5214, Fax. +60 3 757 4880

Mexico: 5900 Gateway East, Suite 200, EL PASO, TEXAS 79905,
Tel. +9-5 800 234 7381

Middle East: see Italy

Netherlands: Postbus 90050, 5600 PB EINDHOVEN, Bldg. VB,
Tel. +31 40 27 82785, Fax. +31 40 27 88399

New Zealand: 2 Wagener Place, C.P.O. Box 1041, AUCKLAND,
Tel. +64 9 849 4160, Fax. +64 9 849 7811

Norway: Box 1, Manglerud 0612, OSLO,
Tel. +47 22 74 8000, Fax. +47 22 74 8341

Philippines: Philips Semiconductors Philippines Inc.,
106 Valero St. Salcedo Village, P.O. Box 2108 MCC, MAKATI,
Metro MANILA, Tel. +63 2 816 6380, Fax. +63 2 817 3474

Poland: Ul. Lukiska 10, PL 04-123 WARSZAWA,
Tel. +48 22 612 2831, Fax. +48 22 612 2327

Portugal: see Spain

Romania: see Italy

Russia: Philips Russia, Ul. Usatcheva 35A, 119048 MOSCOW,
Tel. +7 095 247 9145, Fax. +7 095 247 9144

Singapore: Lorong 1, Toa Payoh, SINGAPORE 1231,
Tel. +65 350 2538, Fax. +65 251 6500

Slovakia: see Austria

Slovenia: see Italy

South Africa: S.A. PHILIPS Pty Ltd., 195-215 Main Road Martindale,
2092 JOHANNESBURG, P.O. Box 7430 Johannesburg 2000,
Tel. +27 11 470 5911, Fax. +27 11 470 5494

South America: Rua do Rocio 220, 5th floor, Suite 51,
04552-903 São Paulo, SÃO PAULO - SP, Brazil,
Tel. +55 11 821 2333, Fax. +55 11 829 1849

Spain: Balmes 22, 08007 BARCELONA,
Tel. +34 3 301 6312, Fax. +34 3 301 4107

Sweden: Kottbygatan 7, Akalla, S-16485 STOCKHOLM,
Tel. +46 8 632 2000, Fax. +46 8 632 2745

Switzerland: Allmendstrasse 140, CH-8027 ZÜRICH,
Tel. +41 1 488 2686, Fax. +41 1 481 7730

Taiwan: PHILIPS TAIWAN Ltd., 23-30F, 66,
Chung Hsiao West Road, Sec. 1, P.O. Box 22978,
TAIPEI 100, Tel. +886 2 382 4443, Fax. +886 2 382 4444

Thailand: PHILIPS ELECTRONICS (THAILAND) Ltd.,
209/2 Sanpavuth-Bangna Road Prakanong, BANGKOK 10260,
Tel. +66 2 745 4090, Fax. +66 2 398 0793

Turkey: Talatpasa Cad. No. 5, 80640 GÜLTEPE/ISTANBUL,
Tel. +90 212 279 2770, Fax. +90 212 282 6707

Ukraine: PHILIPS UKRAINE, 4 Patrice Lumumba str., Building B, Floor 7,
252042 KIEV, Tel. +380 44 264 2776, Fax. +380 44 268 0461

United Kingdom: Philips Semiconductors Ltd., 276 Bath Road, Hayes,
MIDDLESEX UB3 5BX, Tel. +44 181 730 5000, Fax. +44 181 754 8421

United States: 811 East Arques Avenue, SUNNYVALE, CA 94088-3409,
Tel. +1 800 234 7381

Uruguay: see South America

Vietnam: see Singapore

Yugoslavia: PHILIPS, Trg N. Pasica 5/v, 11000 BEOGRAD,
Tel. +381 11 625 344, Fax. +381 11 635 777

For all other countries apply to: Philips Semiconductors, Marketing & Sales Communications,
Building BE-p, P.O. Box 218, 5600 MD EINDHOVEN, The Netherlands, Fax. +31 40 27 24825

Internet: <http://www.semiconductors.philips.com>

© Philips Electronics N.V. 1996

SCA52

All rights are reserved. Reproduction in whole or in part is prohibited without the prior written consent of the copyright owner.

The information presented in this document does not form part of any quotation or contract, is believed to be accurate and reliable and may be changed without notice. No liability will be accepted by the publisher for any consequence of its use. Publication thereof does not convey nor imply any license under patent- or other industrial or intellectual property rights.

Printed in The Netherlands

537021/50/02/pp44

Date of release: 1996 Oct 14

Document order number: 9397 750 01024

Let's make things better.

Philips
Semiconductors



PHILIPS