

Radiation Hardened, SEGR Resistant N-Channel Power MOSFETs



Fairchild Star*Power Rad Hard MOSFETs have been specifically developed for high performance applications in a commercial or military space environment.

Star*Power MOSFETs offer the system designer both extremely low $r_{DS(ON)}$ and Gate Charge allowing the development of low loss Power Subsystems. Star*Power Gold FETs combine this electrical capability with total dose radiation hardness up to 100K RADs while maintaining the guaranteed performance for Single Event Effects (SEE) which the Fairchild FS families have always featured.

The Fairchild family of Star*Power FETs includes a series of devices in various voltage, current and package styles. The portfolio consists of Star*Power and Star*Power Gold products. Star*Power FETs are optimized for total dose and $r_{DS(ON)}$ while exhibiting SEE capability at full rated voltage up to an LET of 37. Star*Power Gold FETs have been optimized for SEE and Gate Charge combining SEE performance to 80% of the rated voltage for an LET of 82 with extremely low gate charge characteristics.

This MOSFET is an enhancement-mode silicon-gate power field effect transistor of the vertical DMOS (VDMOS) structure. It is specifically designed and processed to be radiation tolerant. The MOSFET is well suited for applications exposed to radiation environments such as switching regulation, switching converters, power distribution, motor drives and relay drivers as well as other power control and conditioning applications. As with conventional MOSFETs these Radiation Hardened MOSFETs offer ease of voltage control, fast switching speeds and ability to parallel switching devices.

Reliability screening is available as either TXV or Space equivalent of MIL-PRF-19500.

Formerly available as type TA45232W.

Ordering Information

| RAD LEVEL | SCREENING LEVEL | PART NUMBER/BRAND |
|-----------|---------------------|-------------------|
| 10K | Engineering samples | FSGYE234D1 |
| 100K | TXV | FSGYE234R3 |
| 100K | Space | FSGYE234R4 |

Features

- 9A, 250V, $r_{DS(ON)} = 0.225\Omega$
- UIS Rated
- Total Dose
 - Meets Pre-RAD Specifications to 100K RAD (Si)
- Single Event
 - Safe Operating Area Curve for Single Event Effects
 - SEE Immunity for LET of 82MeV/mg/cm² with V_{DS} up to 80% of Rated Breakdown and V_{GS} of 5V Off-Bias
- Dose Rate
 - Typically Survives 3E9 RAD (Si)/s at 80% BV_{DSS}
 - Typically Survives 2E12 if Current Limited to I_{AS}
- Photo Current
 - 4.0nA Per-RAD (Si)/s Typically
- Neutron
 - Maintain Pre-RAD Specifications for 1E13 Neutrons/cm²
 - Usable to 1E14 Neutrons/cm²

Symbol

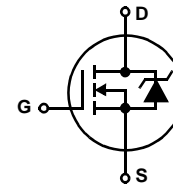

Packaging

SMD.5

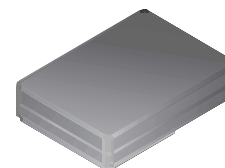

FSGYE234R

Absolute Maximum Ratings $T_C = 25^\circ\text{C}$, Unless Otherwise Specified

| | FSGYE234R | UNITS |
|--|--------------|---------------------|
| Drain to Source Voltage | 250 | V |
| Drain to Gate Voltage ($R_{GS} = 20k\Omega$) | 250 | V |
| Continuous Drain Current | | |
| $T_C = 25^\circ\text{C}$ | 9 | A |
| $T_C = 100^\circ\text{C}$ | 6 | A |
| Pulsed Drain Current | 32 | A |
| Gate to Source Voltage | ± 30 | V |
| Maximum Power Dissipation | | |
| $T_C = 25^\circ\text{C}$ | 42 | W |
| $T_C = 100^\circ\text{C}$ | 17 | W |
| Linear Derating Factor | 0.33 | W/ $^\circ\text{C}$ |
| Single Pulsed Avalanche Current, $L = 100\mu\text{H}$, (See Test Figure) | 30 | A |
| Continuous Source Current (Body Diode) | 9 | A |
| Pulsed Source Current (Body Diode) | 32 | A |
| Operating and Storage Temperature | -55 to 150 | $^\circ\text{C}$ |
| Lead Temperature (During Soldering) (Distance $>0.063\text{in}$ (1.6mm) from Case, 10s Max) | 300 | $^\circ\text{C}$ |
| Weight (Typical) | 1.0(Typical) | g |

CAUTION: Stresses above those listed in "Absolute Maximum Ratings" may cause permanent damage to the device. This is a stress only rating and operation of the device at these or any other conditions above those indicated in the operational sections of this specification is not implied.

Electrical Specifications $T_C = 25^\circ\text{C}$, Unless Otherwise Specified

| PARAMETER | SYMBOL | TEST CONDITIONS | MIN | TYP | MAX | UNITS | |
|-------------------------------------|-----------------|--|---|------|-------|-------|--------------------|
| Drain to Source Breakdown Voltage | BV_{DSS} | $I_D = 1\text{mA}$, $V_{GS} = 0\text{V}$ | 250 | - | - | V | |
| Gate Threshold Voltage | $V_{GS(TH)}$ | $V_{GS} = V_{DS}$, $I_D = 1\text{mA}$ | $T_C = -55^\circ\text{C}$ | - | - | 5.5 | V |
| | | | $T_C = 25^\circ\text{C}$ | 2.0 | - | 4.5 | V |
| | | | $T_C = 125^\circ\text{C}$ | 1.0 | - | - | V |
| Zero Gate Voltage Drain Current | I_{DSS} | $V_{DS} = 200\text{V}$, $V_{GS} = 0\text{V}$ | $T_C = 25^\circ\text{C}$ | - | - | 25 | μA |
| | | | $T_C = 125^\circ\text{C}$ | - | - | 250 | μA |
| Gate to Source Leakage Current | I_{GSS} | $V_{GS} = \pm 30\text{V}$ | $T_C = 25^\circ\text{C}$ | - | - | 100 | nA |
| | | | $T_C = 125^\circ\text{C}$ | - | - | 200 | nA |
| Drain to Source On-State Voltage | $V_{DS(ON)}$ | $V_{GS} = 12\text{V}$, $I_D = 9\text{A}$ | - | - | 2.07 | V | |
| Drain to Source On Resistance | $r_{DS(ON)12}$ | $I_D = 6\text{A}$, $V_{GS} = 12\text{V}$ | $T_C = 25^\circ\text{C}$ | - | 0.185 | 0.225 | Ω |
| | | | $T_C = 125^\circ\text{C}$ | - | - | 0.432 | Ω |
| Turn-On Delay Time | $t_{d(ON)}$ | $V_{DD} = 125\text{V}$, $I_D = 9\text{A}$, $R_L = 13.9\Omega$, $V_{GS} = 12\text{V}$, $R_{GS} = 7.5\Omega$ | - | - | 20 | ns | |
| Rise Time | t_r | | - | - | 25 | ns | |
| Turn-Off Delay Time | $t_{d(OFF)}$ | | - | - | 30 | ns | |
| Fall Time | t_f | | - | - | 15 | ns | |
| Total Gate Charge | $Q_{g(12)}$ | $V_{GS} = 0\text{V}$ to 12V | $V_{DD} = 125\text{V}$, $I_D = 9\text{A}$ | - | 26 | 28 | nC |
| Gate Charge Source | Q_{gs} | | | - | 10 | 12 | nC |
| Gate Charge Drain | Q_{gd} | | | - | 8 | 10 | nC |
| Gate Charge at 20V | $Q_{g(20)}$ | $V_{GS} = 0\text{V}$ to 20V | | - | 40 | - | nC |
| Threshold Gate Charge | $Q_{g(TH)}$ | $V_{GS} = 0\text{V}$ to 2V | | - | 3 | - | nC |
| Plateau Voltage | $V_{(PLATEAU)}$ | $I_D = 9\text{A}$, $V_{DS} = 15\text{V}$ | - | 7 | - | V | |
| Input Capacitance | C_{ISS} | $V_{DS} = 25\text{V}$, $V_{GS} = 0\text{V}$, $f = 1\text{MHz}$ | - | 1300 | - | pF | |
| Output Capacitance | C_{OSS} | | - | 200 | - | pF | |
| Reverse Transfer Capacitance | C_{RSS} | | - | 8 | - | pF | |
| Thermal Resistance Junction to Case | $R_{\theta JC}$ | | - | - | 3.0 | - | $^\circ\text{C/W}$ |

FSGYE234R

Source to Drain Diode Specifications

| PARAMETER | SYMBOL | TEST CONDITIONS | MIN | TYP | MAX | UNITS |
|-------------------------|----------|--|-----|-----|-----|---------|
| Forward Voltage | V_{SD} | $I_{SD} = 9A$ | - | - | 1.2 | V |
| Reverse Recovery Time | t_{rr} | $I_{SD} = 9A, dI_{SD}/dt = 100A/\mu s$ | - | - | 310 | ns |
| Reverse Recovery Charge | Q_{RR} | | - | 1.9 | - | μC |

Electrical Specifications up to 100K RAD $T_C = 25^\circ C$, Unless Otherwise Specified

| PARAMETER | SYMBOL | TEST CONDITIONS | MIN | MAX | UNITS |
|---------------------------------|-----------------------------|---------------------------------|-----|-------|----------|
| Drain to Source Breakdown Volts | (Note 3) BV_{DSS} | $V_{GS} = 0, I_D = 1mA$ | 250 | - | V |
| Gate to Source Threshold Volts | (Note 3) $V_{GS(TH)}$ | $V_{GS} = V_{DS}, I_D = 1mA$ | 2.0 | 4.5 | V |
| Gate to Body Leakage | (Notes 2, 3) I_{GSS} | $V_{GS} = \pm 30V, V_{DS} = 0V$ | - | 100 | nA |
| Zero Gate Leakage | (Note 3) I_{DSS} | $V_{GS} = 0, V_{DS} = 200V$ | - | 25 | μA |
| Drain to Source On-State Volts | (Notes 1, 3) $V_{DS(ON)}$ | $V_{GS} = 12V, I_D = 9A$ | - | 2.07 | V |
| Drain to Source On Resistance | (Notes 1, 3) $r_{DS(ON)12}$ | $V_{GS} = 12V, I_D = 6A$ | - | 0.225 | Ω |

NOTES:

1. Pulse test, 300 μs Max.
2. Absolute value.
3. Insitu Gamma bias must be sampled for both $V_{GS} = 12V, V_{DS} = 0V$ and $V_{GS} = 0V, V_{DS} = 80\% BV_{DSS}$.

Single Event Effects (SEB, SEGR) Note 4

| TEST | SYMBOL | ENVIRONMENT (NOTE 5) | | | APPLIED V_{GS} BIAS (V) | (NOTE 6) MAXIMUM V_{DS} BIAS (V) |
|--|---------|----------------------|-------------------------|-------------------------|---------------------------|------------------------------------|
| | | ION SPECIES | TYPICAL LET (MeV/mg/cm) | TYPICAL RANGE (μ) | | |
| Single Event Effects Safe Operating Area | SEESOAS | Br | 37 | 36 | -20 | 250 |
| | | I | 60 | 32 | -10 | 250 |
| | | Au | 82 | 28 | -5 | 200 |
| | | Au | 82 | 28 | -10 | 150 |

NOTES:

4. Testing conducted at Brookhaven National Labs.
5. Fluence = 1E5 ions/cm² (Typical), T = 25 $^\circ C$.
6. Does not exhibit Single Event Burnout (SEB) or Single Event Gate Rupture (SEGR).

Performance Curves Unless Otherwise Specified

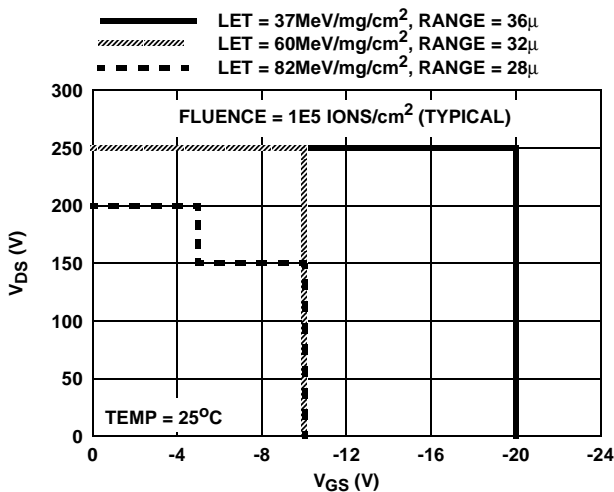

FIGURE 1. SINGLE EVENT EFFECTS SAFE OPERATING AREA

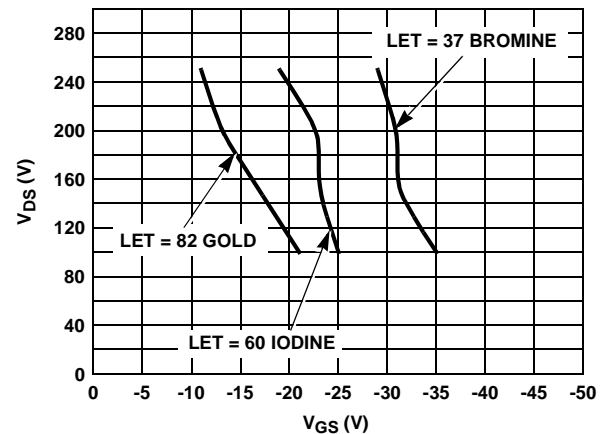

FIGURE 2. TYPICAL SEE SIGNATURE CURV E

Performance Curves Unless Otherwise Specified (Continued)

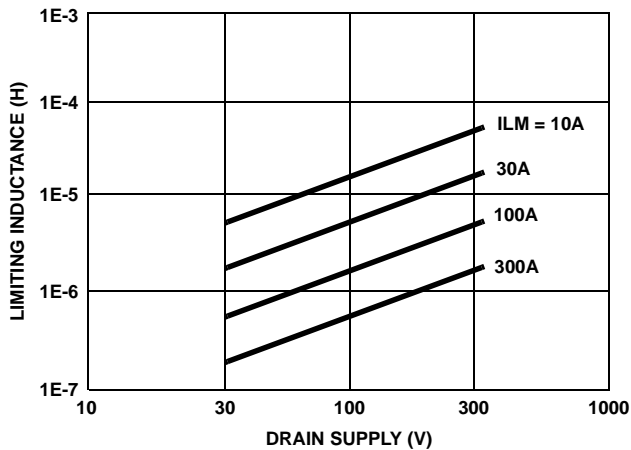

FIGURE 3. TYPICAL DRAIN INDUCTANCE REQUIRED TO LIMIT GAMMA DOT CURRENT TO I_{AS}

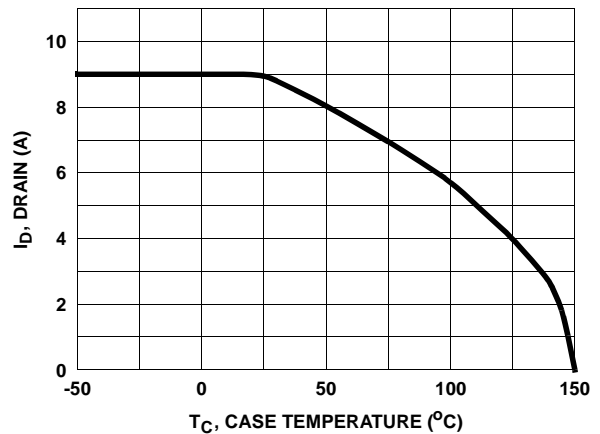

FIGURE 4. MAXIMUM CONTINUOUS DRAIN CURRENT vs TEMPERATURE

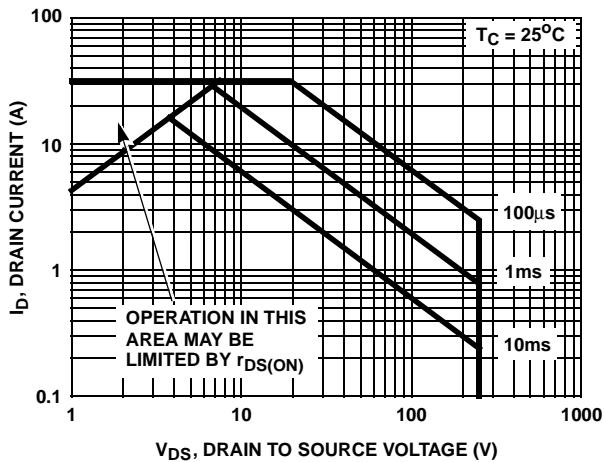

FIGURE 5. FORWARD BIAS SAFE OPERATING AREA

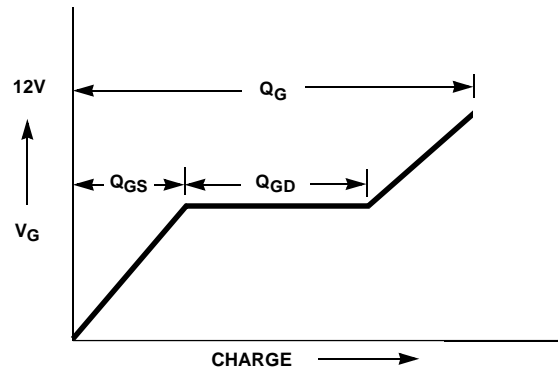

FIGURE 6. BASIC GATE CHARGE WAVEFORM

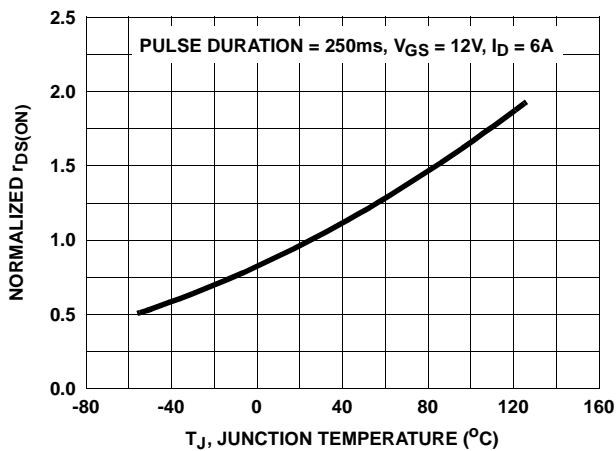

FIGURE 7. TYPICAL NORMALIZED $r_{DS(ON)}$ vs JUNCTION TEMPERATURE

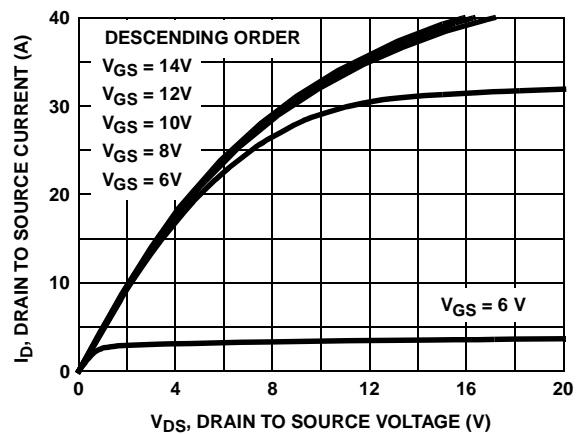

FIGURE 8. TYPICAL OUTPUT CHARACTERISTICS

Performance Curves Unless Otherwise Specified (Continued)

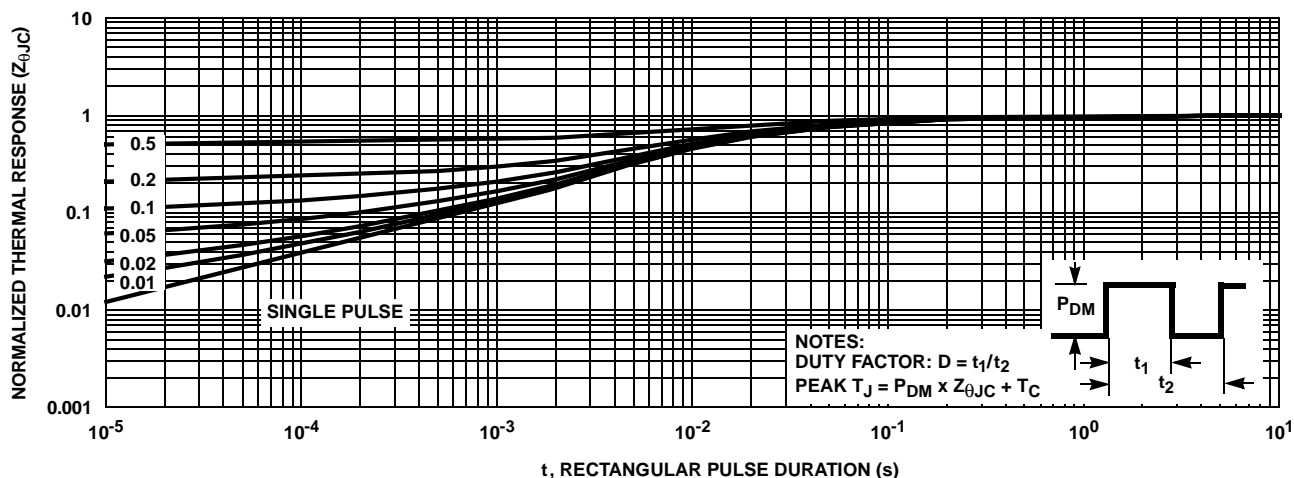

FIGURE 9. NORMALIZED MAXIMUM TRANSIENT THERMAL RESPONSE

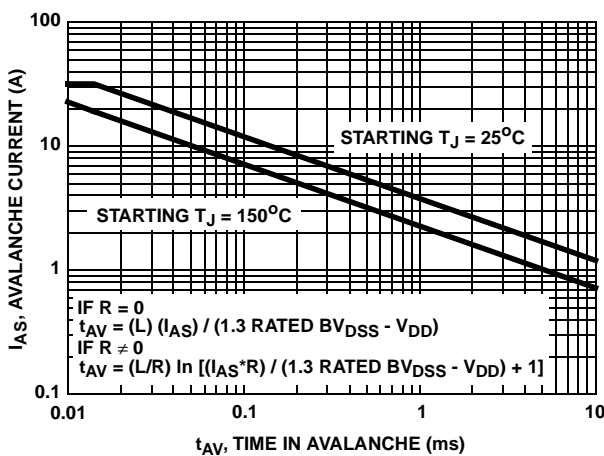

FIGURE 10. UNCLAMPED INDUCTIVE SWITCHING

Test Circuits and Waveforms

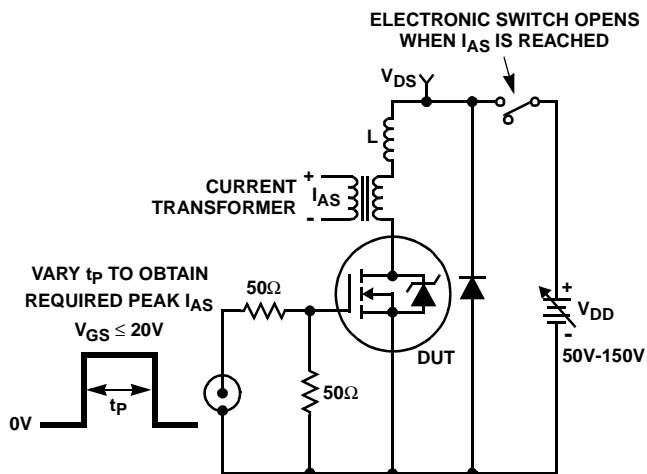

FIGURE 11. UNCLAMPED ENERGY TEST CIRCUIT

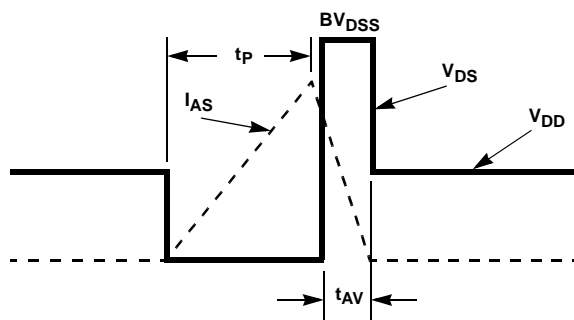

FIGURE 12. UNCLAMPED ENERGY WAVEFORMS

Test Circuits and Waveforms (Continued)

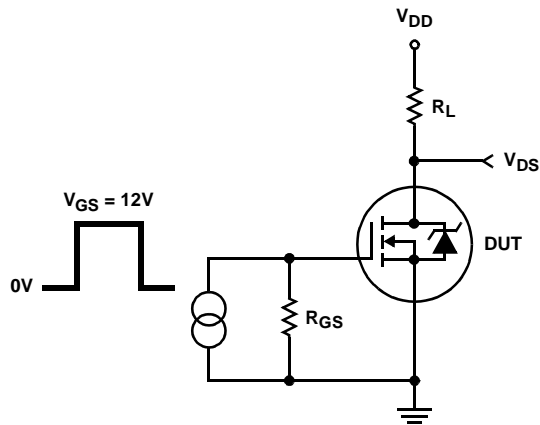

FIGURE 13. RESISTIVE SWITCHING TEST CIRCUIT

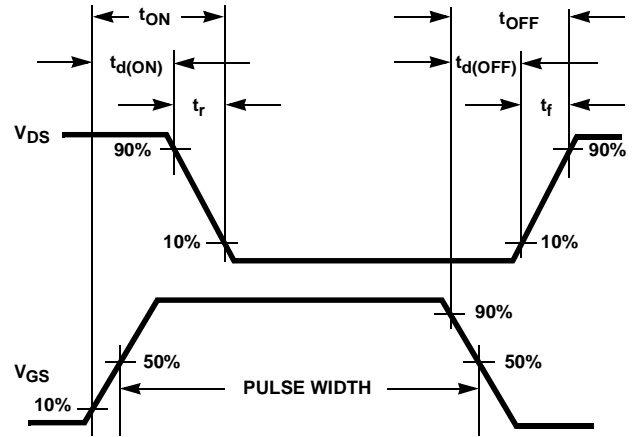

FIGURE 14. RESISTIVE SWITCHING WAVEFORMS

Screening Information

Screening is performed in accordance with the latest revision in effect of MIL-S-19500, (Screening Information Table).

Delta Tests and Limits (JANTXV Equivalent, JANS Equivalent) $T_C = 25^\circ C$, Unless Otherwise Specified

| PARAMETER | SYMBOL | TEST CONDITIONS | MAX | UNITS |
|---------------------------------|--------------|-----------------------------------|---------------------|----------|
| Gate to Source Leakage Current | I_{GSS} | $V_{GS} = \pm 30V$ | ± 20 (Note 7) | nA |
| Zero Gate Voltage Drain Current | I_{DSS} | $V_{DS} = 80\%$ Rated Value | ± 25 (Note 7) | μA |
| Drain to Source On Resistance | $r_{DS(ON)}$ | $T_C = 25^\circ C$ at Rated I_D | $\pm 20\%$ (Note 8) | Ω |
| Gate Threshold Voltage | $V_{GS(TH)}$ | $I_D = 1.0mA$ | $\pm 20\%$ (Note 8) | V |

NOTES:

- 7. Or 100% of Initial Reading (whichever is greater).
- 8. Of Initial Reading.

Screening Information

| TEST | JANTXV EQUIVALENT | JANS EQUIVALENT |
|--|--|--|
| Unclamped Inductive Switching | $V_{GS(PEAK)} = 20V$, $L = 0.1mH$; Limit = 30A | $V_{GS(PEAK)} = 20V$, $L = 0.1mH$; Limit = 30A |
| Thermal Response | $t_H = 10ms$; $V_H = 25V$; $I_H = 1A$; LIMIT = 74mV | $t_H = 10ms$; $V_H = 25V$; $I_H = 1A$; LIMIT = 74mV |
| Gate Stress | $V_{GS} = 45V$, $t = 250\mu s$ | $V_{GS} = 45V$, $t = 250\mu s$ |
| Pind | Optional | Required |
| Pre Burn-In Tests (Note 9) | MIL-S-19500 Group A, Subgroup 2 (All Static Tests at $25^\circ C$) | MIL-S-19500 Group A, Subgroup 2 (All Static Tests at $25^\circ C$) |
| Steady State Gate Bias (Gate Stress) | MIL-STD-750, Method 1042, Condition B $V_{GS} = 80\%$ of Rated Value, $T_A = 150^\circ C$, Time = 48 hours | MIL-STD-750, Method 1042, Condition B $V_{GS} = 80\%$ of Rated Value, $T_A = 150^\circ C$, Time = 48 hours |
| Interim Electrical Tests (Note 9) | All Delta Parameters Listed in the Delta Tests and Limits Table | All Delta Parameters Listed in the Delta Tests and Limits Table |
| Steady State Reverse Bias (Drain Stress) | MIL-STD-750, Method 1042, Condition A $V_{DS} = 80\%$ of Rated Value, $T_A = 150^\circ C$, Time = 160 hours | MIL-STD-750, Method 1042, Condition A $V_{DS} = 80\%$ of Rated Value, $T_A = 150^\circ C$, Time = 240 hours |
| PDA | 10% | 5% |
| Final Electrical Tests (Note 9) | MIL-S-19500, Group A, Subgroup 2 | MIL-S-19500, Group A, Subgroups 2 and 3 |

NOTE:

- 9. Test limits are identical pre and post burn-in.

Additional Tests

| PARAMETER | SYMBOL | TEST CONDITIONS | MAX | UNITS |
|---------------------|-----------------|--|------|-------|
| Safe Operating Area | SOA | $V_{DS} = 200V$, $t = 10ms$ | 0.30 | A |
| Thermal Impedance | ΔV_{SD} | $t_H = 100ms$; $V_H = 25V$; $I_H = 1A$ | 165 | mV |

Rad Hard Data Packages - Fairchild Power Transistors

TXV Equivalent

1. RAD HARD TXV EQUIVALENT - STANDARD DATA PACKAGE

- A. Certificate of Compliance
- B. Assembly Flow Chart
- C. Preconditioning - Attributes Data Sheet
- D. Group A - Attributes Data Sheet
- E. Group B - Attributes Data Sheet
- F. Group C - Attributes Data Sheet
- G. Group D - Attributes Data Sheet

2. RAD HARD TXV EQUIVALENT - OPTIONAL DATA PACKAGE

- A. Certificate of Compliance
- B. Assembly Flow Chart
- C. Preconditioning - Attributes Data Sheet
 - Pre and Post Burn-In Read and Record Data
- D. Group A - Attributes Data Sheet
- E. Group B - Attributes Data Sheet
 - Pre and Post Read and Record Data for Intermittent Operating Life (Subgroup B3)
 - Bond Strength Data (Subgroup B3)
 - Pre and Post High Temperature Operating Life Read and Record Data (Subgroup B6)
- F. Group C - Attributes Data Sheet
 - Pre and Post Read and Record Data for Intermittent Operating Life (Subgroup C6)
 - Bond Strength Data (Subgroup C6)
- G. Group D - Attributes Data Sheet
 - Pre and Post RAD Read and Record Data

Class S - Equivalents

1. RAD HARD "S" EQUIVALENT - STANDARD DATA PACKAGE

- A. Certificate of Compliance
- B. Serialization Records
- C. Assembly Flow Chart
- D. SEM Photos and Report
- E. Preconditioning - Attributes Data Sheet
 - HTRB - Hi Temp Gate Stress Post Reverse Bias Data and Delta Data
 - HTRB - Hi Temp Drain Stress Post Reverse Bias Delta Data
- F. Group A - Attributes Data Sheet
- G. Group B - Attributes Data Sheet
- H. Group C - Attributes Data Sheet
- I. Group D - Attributes Data Sheet

2. RAD HARD MAX. "S" EQUIVALENT - OPTIONAL DATA PACKAGE

- A. Certificate of Compliance
- B. Serialization Records
- C. Assembly Flow Chart
- D. SEM Photos and Report
- E. Preconditioning - Attributes Data Sheet
 - HTRB - Hi Temp Gate Stress Post Reverse Bias Data and Delta Data
 - HTRB - Hi Temp Drain Stress Post Reverse Bias Delta Data
 - X-Ray and X-Ray Report
- F. Group A - Attributes Data Sheet
 - Subgroups A2, A3, A4, A5 and A7 Data
- G. Group B - Attributes Data Sheet
 - Subgroups B1, B3, B4, B5 and B6 Data
- H. Group C - Attributes Data Sheet
 - Subgroups C1, C2, C3 and C6 Data
- I. Group D - Attributes Data Sheet
 - Pre and Post Radiation Data