

**Dual common source
NPT IGBT Power Module**

**$V_{CES} = 1200V$
 $I_C = 100A @ T_c = 80^\circ C$**

Application

- AC Switches
- Switched Mode Power Supplies
- Uninterruptible Power Supplies

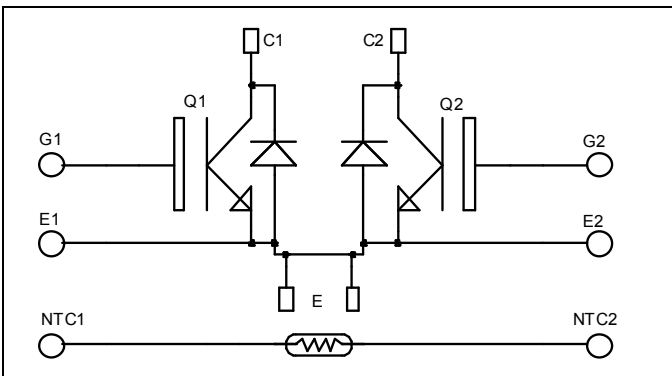

Features

- Non Punch Through (NPT) FAST IGBT
 - Low voltage drop
 - Low tail current
 - Switching frequency up to 50 kHz
 - Soft recovery parallel diodes
 - Low diode VF
 - Low leakage current
 - Avalanche energy rated
 - RBSOA and SCSOA rated
- Kelvin emitter for easy drive
- Very low stray inductance
 - Symmetrical design
 - Lead frames for power connections
- Internal thermistor for temperature monitoring
- High level of integration

Benefits

- Outstanding performance at high frequency operation
- Stable temperature behavior
- Very rugged
- Direct mounting to heatsink (isolated package)
- Low junction to case thermal resistance
- Solderable terminals both for power and signal for easy PCB mounting
- Easy paralleling due to positive TC of VCEsat
- Low profile

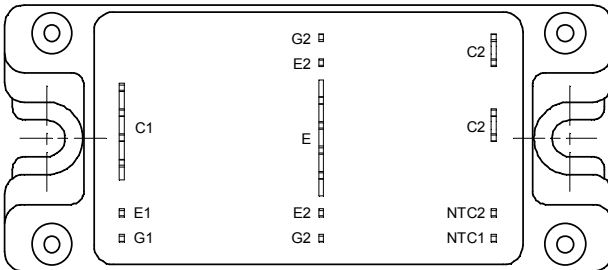

Absolute maximum ratings

Symbol	Parameter	Max ratings	Unit
V_{CES}	Collector - Emitter Breakdown Voltage	1200	V
I_C	Continuous Collector Current	$T_c = 25^\circ C$	150
		$T_c = 80^\circ C$	100
I_{CM}	Pulsed Collector Current	$T_c = 25^\circ C$	300
V_{GE}	Gate – Emitter Voltage	± 20	V
P_D	Maximum Power Dissipation	$T_c = 25^\circ C$	568
RBSOA	Reverse Bias Safe Operating Area	$T_j = 150^\circ C$	300A @ 1200V

CAUTION: These Devices are sensitive to Electrostatic Discharge. Proper Handling Procedures Should Be Followed.

All ratings @ $T_j = 25^\circ\text{C}$ unless otherwise specified

Electrical Characteristics

Symbol	Characteristic	Test Conditions	Min	Typ	Max	Unit
BV_{CES}	Collector - Emitter Breakdown Voltage	$V_{GE} = 0V, I_C = 750 \mu A$	1200			V
I_{CES}	Zero Gate Voltage Collector Current	$V_{GE} = 0V$ $V_{CE} = 1200V$			750 3750	μA
$V_{CE(on)}$	Collector Emitter on Voltage	$V_{GE} = 15V$ $I_C = 100A$		3.2 4.0	3.7	V
$V_{GE(th)}$	Gate Threshold Voltage	$V_{GE} = V_{CE}, I_C = 2 mA$	4.5		6.5	V
I_{GES}	Gate - Emitter Leakage Current	$V_{GE} = 20 V, V_{CE} = 0V$			150	nA

Dynamic Characteristics

Symbol	Characteristic	Test Conditions	Min	Typ	Max	Unit
C_{ies}	Input Capacitance	$V_{GE} = 0V$		6900		pF
C_{oes}	Output Capacitance	$V_{CE} = 25V$		660		
C_{res}	Reverse Transfer Capacitance	$f = 1MHz$		440		
Q_g	Total gate Charge	$V_{GS} = 15V$		660		nC
Q_{ge}	Gate - Emitter Charge	$V_{Bus} = 600V$		70		
Q_{gc}	Gate - Collector Charge	$I_C = 100A$		400		
$T_{d(on)}$	Turn-on Delay Time	Inductive Switching (25°C)		35		ns
T_r	Rise Time	$V_{GE} = 15V$		65		
$T_{d(off)}$	Turn-off Delay Time	$V_{Bus} = 600V$		320		
T_f	Fall Time	$I_C = 100A$		30		
E_{on}	Turn-on Switching Energy ❶	$R_G = 2.5 \Omega$		10.8		
E_{off}	Turn-off Switching Energy ❷			4.6		mJ
$T_{d(on)}$	Turn-on Delay Time	Inductive Switching (125°C)		35		ns
T_r	Rise Time	$V_{GE} = 15V$		65		
$T_{d(off)}$	Turn-off Delay Time	$V_{Bus} = 600V$		360		
T_f	Fall Time	$I_C = 100A$		40		
E_{on}	Turn-on Switching Energy ❶	$R_G = 2.5 \Omega$		13.9		
E_{off}	Turn-off Switching Energy ❷			6.1		mJ

Reverse diode ratings and characteristics

Symbol	Characteristic	Test Conditions	Min	Typ	Max	Unit
$I_{F(AV)}$	Maximum Average Forward Current	50% duty cycle $T_c = 70^\circ\text{C}$		120		A
V_F	Diode Forward Voltage	$I_F = 120A$		2.0	2.5	V
		$I_F = 240A$		2.3		
		$I_F = 120A$ $T_j = 125^\circ\text{C}$		1.8		
t_{rr}	Reverse Recovery Time	$I_F = 120A$ $V_R = 800V$ $di/dt = 800A/\mu s$		370 500		ns
Q_{rr}	Reverse Recovery Charge	$I_F = 120A$ $V_R = 800V$ $di/dt = 800A/\mu s$		2.64 13.8		μC

❶ E_{on} includes diode reverse recovery

❷ In accordance with JEDEC standard JESD24-1

Thermal and package characteristics

Symbol	Characteristic	Min	Typ	Max	Unit
R _{thJC}	Junction to Case	IGBT		0.22	°C/W
		Diode		0.32	
V _{ISOL}	RMS Isolation Voltage, any terminal to case t=1 min, I _{isol} <1mA, 50/60Hz	2500			V
T _J	Operating junction temperature range	-40		150	°C
T _{STG}	Storage Temperature Range	-40		125	
T _C	Operating Case Temperature	-40		100	
Torque	Mounting torque	To heatsink	M5	4.7	N.m
Wt	Package Weight			160	g

Temperature sensor NTC

Symbol	Characteristic	Min	Typ	Max	Unit
R ₂₅	Resistance @ 25°C		68		kΩ
B _{25/85}	T ₂₅ = 298.16 K		4080		K

$$R_T = \frac{R_{25}}{\exp\left[B_{25/85}\left(\frac{1}{T_{25}} - \frac{1}{T}\right)\right]}$$

T: Thermistor temperature
R_T: Thermistor value at T

Package outline

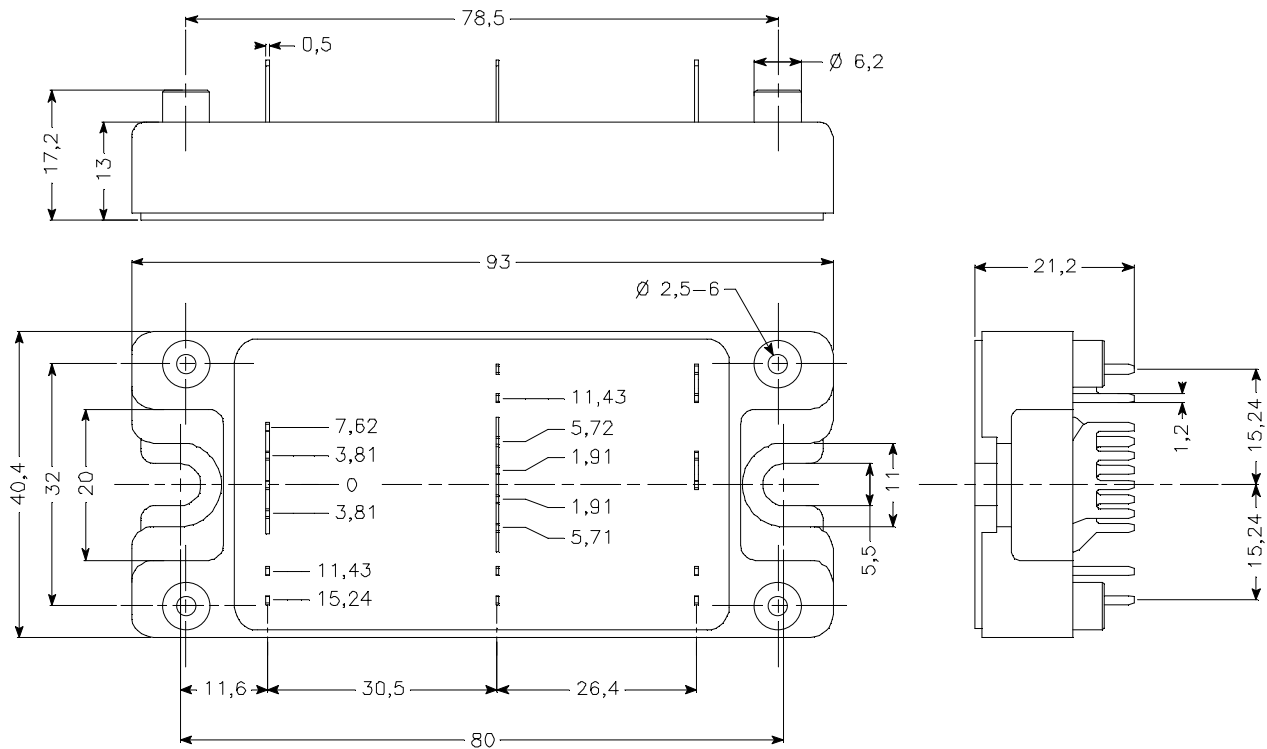

Typical Performance Curve

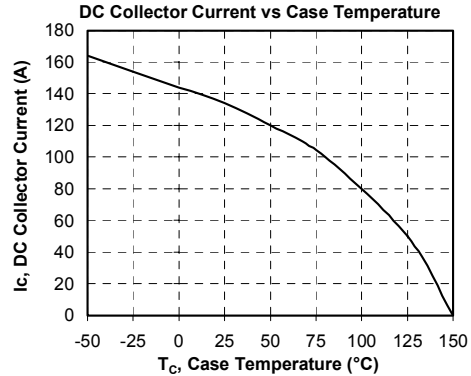
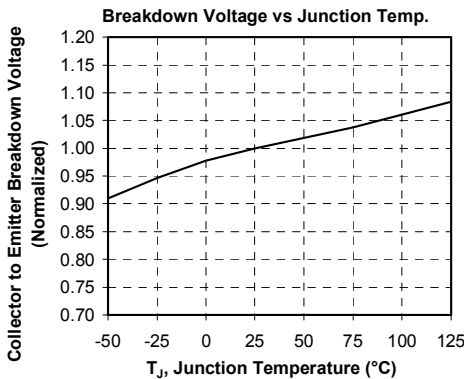
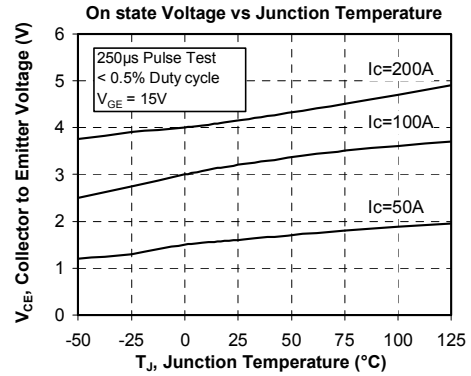
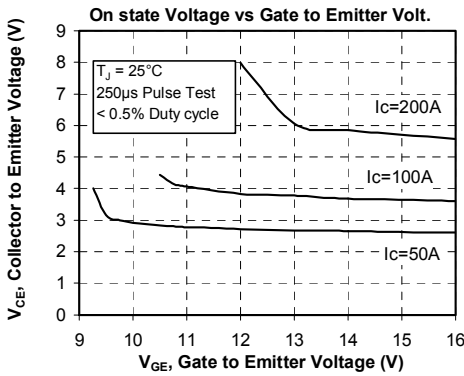
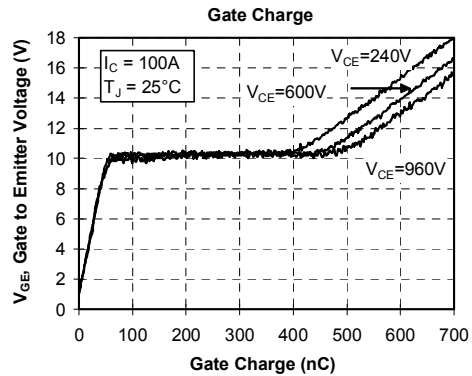
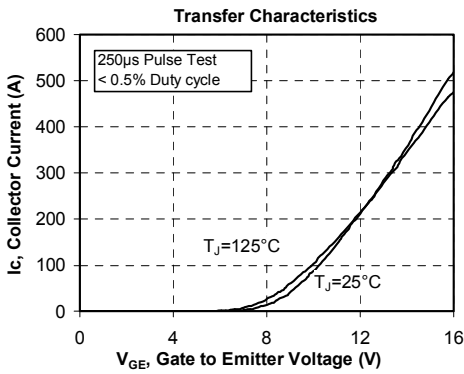
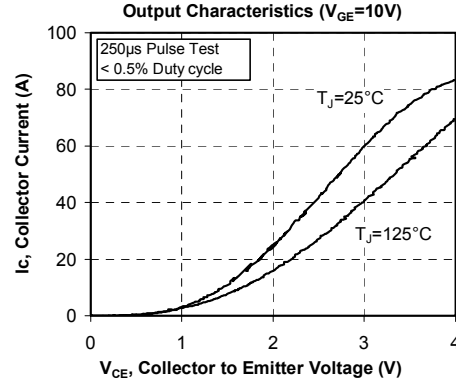
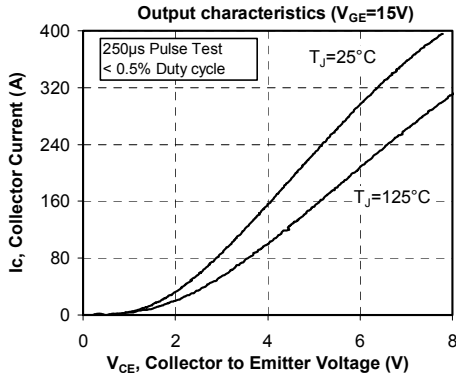

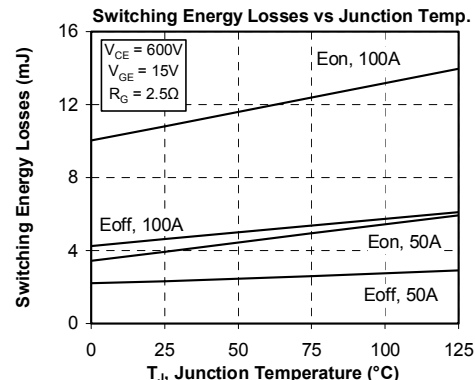
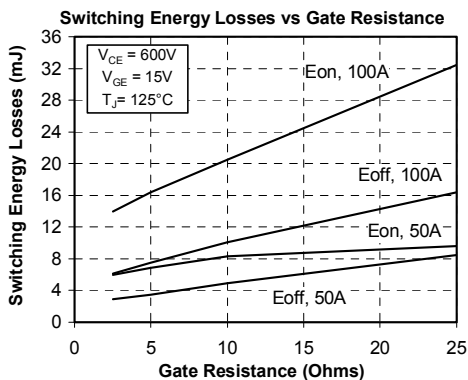
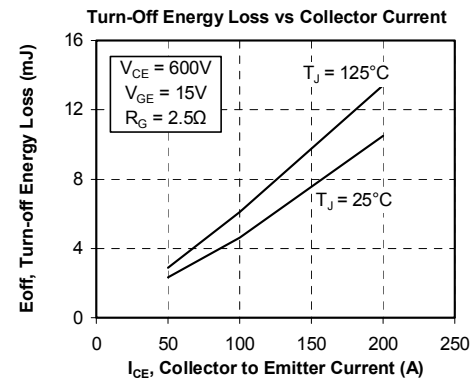
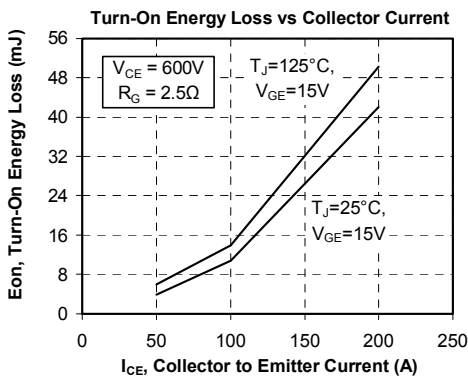
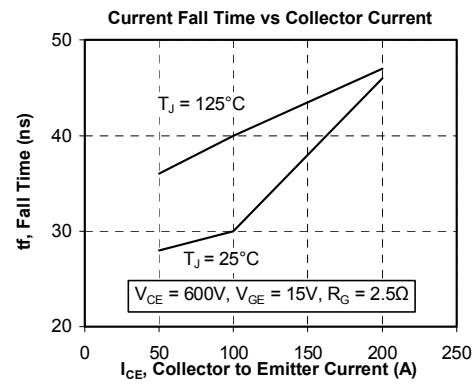
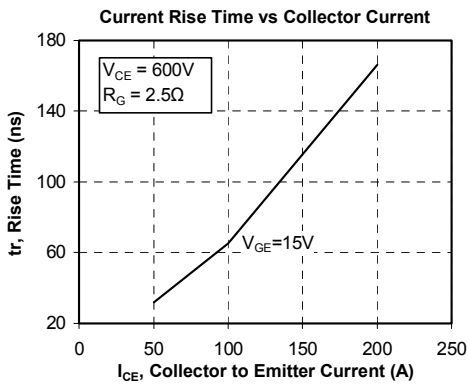
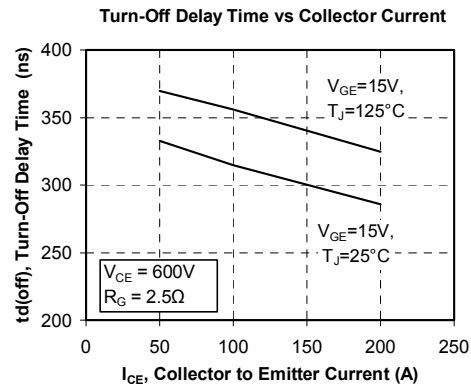
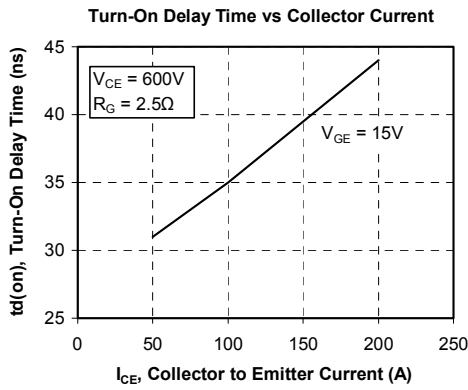

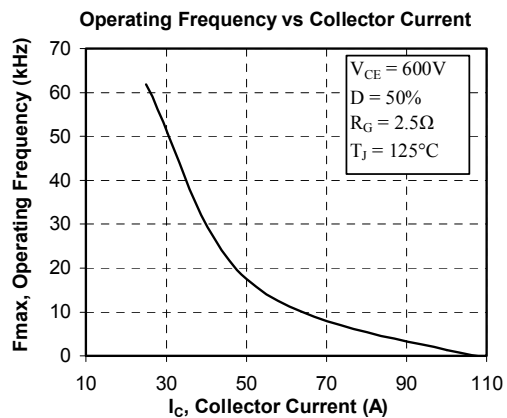
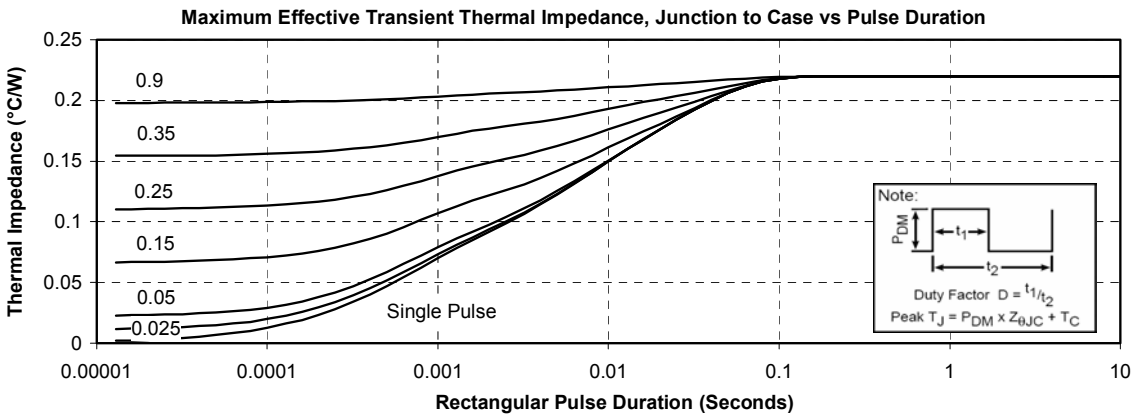
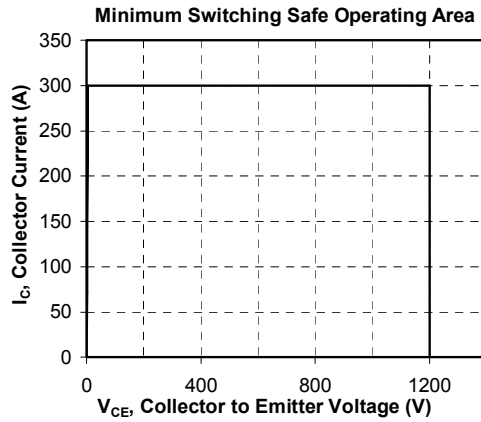
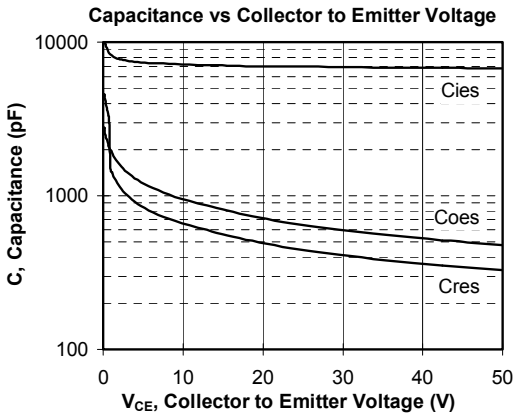

APT reserves the right to change, without notice, the specifications and information contained herein

APT's products are covered by one or more of U.S patents 4,895,810 5,045,903 5,089,434 5,182,234 5,019,522 5,262,336 6,503,786 5,256,583 4,748,103 5,283,202 5,231,474 5,434,095 5,528,058 and foreign patents. U.S and Foreign patents pending. All Rights Reserved.