

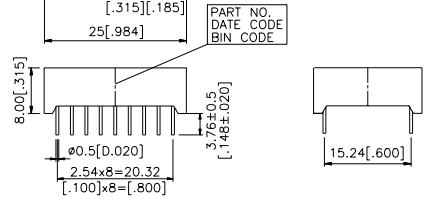

**B.LTD-6x10/6x30/6x40/6x50**

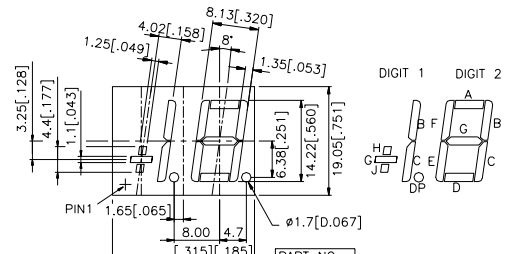

**C.LTC-561/571**

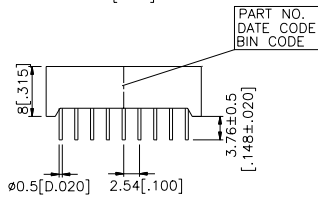
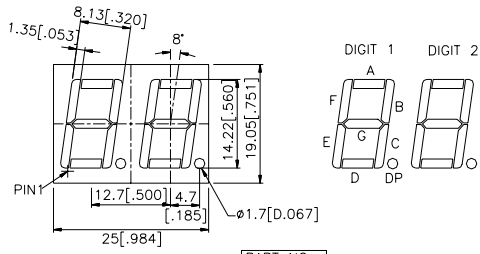
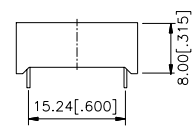
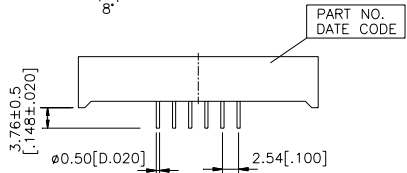
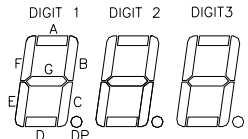
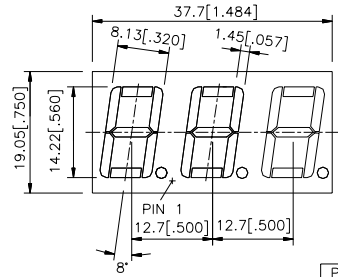

**D.LTC-5623/5723**

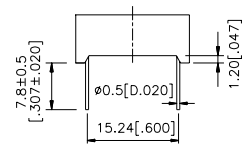
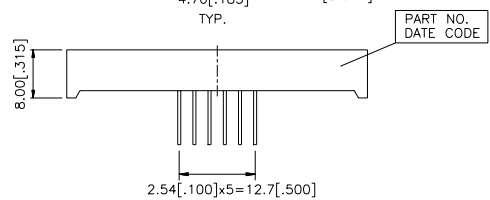
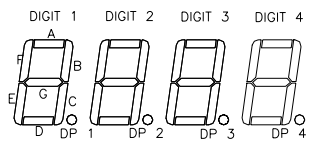
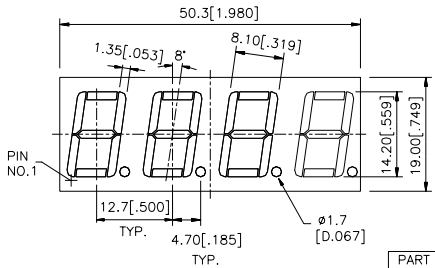

## Devices

Part No.						Description	Package Dimension	Internal Circuit Diagram
AlGaAs Red	Bright Red	Green	Yellow	Red Orange	Hi.-Eff Red			
6760WC	6760P	6460G	6860Y	6660E	6960HR	Common Anode, Rt. Hand Decimal	A	A
6780WC	6780P	6480G	6880Y	6680E	6980HR	Common Cathode, Rt. Hand Decimal	A	B
6775WC	6775P	6475G	6875Y	6675E	6975HR	Common Anode, $\pm 1$ Overflow	A	C
6795WC	6795P	6495G	6895Y	6695E	6995HR	Common Cathode, $\pm 1$ Overflow	A	D
6710WC	6710P	6410G	6810Y	6610E	6910HR	Common Anode, Rt. Hand Decimal	B	E
6730WC	6730P	6430G	6830Y	6630E	6930HR	Common Anode, $\pm 1.8$ Overflow	B	F
6740WC	6740P	6440G	6840Y	6640E	6940HR	Common Cathode, Rt. Hand Decimal	B	G
6750WC	6750P	6450G	6850Y	6650E	6950HR	Common Cathode, $\pm 1.8$ Overflow	B	H
561WC	561P	561G	561Y	561E	561HR	Multiplex Common Anode, Rt. Hand Decimal	C	I
571WC	571P	571G	571Y	571E	571HR	Multiplex Common Cathode, Rt. Hand Decimal	C	J
5723WC	5723P	5623G	5623Y	5623E	5623HR	Multiplex Common Anode, Rt. Hand Decimal	D	K
5623WC	5623P	5723G	5723Y	5723E	5723HR	Multiplex Common Cathode, Rt. Hand Decimal	D	L

## Pin Connection

Pin No.	Connection			
	A.LTS-6x60	B.LTS-6x80	C.LTS-6x75	D.LTS-6x95
1.	Cathode E	Anode E	Cathode Minus Sign	Anode Minus Sign
2.	Cathode D	Anode D	Anode Pl.,Mi *2	Cathode Pl.,Mi *2
3.	Common Anode *1	Common Cathode *1	Cathode C	Anode C
4.	Cathode C	Anode C	Anode B.C.Dp *3	Cathode B.C.Dp *3
5.	Cathode D.P.	Anode D.P.	Cathode Dp	Anode Dp
6.	Cathode B	Anode B	Cathode B	Anode B
7.	Cathode A	Anode A	Anode B.C.Dp *3	Cathode B.C.Dp *3
8.	Common Anode *1	Common Cathode *1	Anode Pl.,Mi *2	Cathode Pl.,Mi *2
9.	Cathode F	Anode F	Cathode Plus Sign	Anode Plus Sign
10.	Cathode G	Anode G	No Connection	No Connection

- Notes: 1.Pin 3&8 are internally connected.  
 2.Pin 2&8 are internally connected.  
 3.Pin 4&7 are internally connected.

Pin No.	Connection			
	E.LTD-6x10	F.LTD-6x30	G.LTD-6x40	H.LTD-6x50
1.	Cathode E (Digit 1)	Cathode G (Digit 1)	Anode E (Digit 1)	Anode G (Digit 1)
2.	Cathode D (Digit 1)	Cathode J.H (Digit 1)	Anode D (Digit 1)	Anode J.H (Digit 1)
3.	Cathode C (Digit 1)	Cathode C (Digit 1)	Anode C (Digit 1)	Anode C (Digit 1)
4.	Cathode D.P. (Digit 1)	Cathode D.P. (Digit 1)	Anode D.P.(Digit 1)	Anode D.P.(Digit 1)
5.	Cathode E (Digit 2)	Cathode E (Digit 2)	Anode E (Digit 2)	Anode E (Digit 2)
6.	Cathode D (Digit 2)	Cathode D (Digit 2)	Anode D (Digit 2)	Anode D (Digit 2)
7.	Cathode G (Digit 2)	Cathode G (Digit 2)	Anode G (Digit 2)	Anode G (Digit 2)
8.	Cathode C (Digit 2)	Cathode C (Digit 2)	Anode C (Digit 2)	Anode C (Digit 2)
9.	Cathode D.P. (Digit 2)	Cathode D.P. (Digit 2)	Anode D.P.(Digit 2)	Anode D.P.(Digit 2)
10.	Cathode B (Digit 2)	Cathode B (Digit 2)	Anode B (Digit 2)	Anode B (Digit 2)
11.	Cathode A (Digit 2)	Cathode A (Digit 2)	Anode A (Digit 2)	Anode A (Digit 2)
12.	Cathode F (Digit 2)	Cathode F (Digit 2)	Anode F (Digit 2)	Anode F (Digit 2)
13.	Common Anode (Digit 2)	Common Anode (Digit 2)	Common Cathode (Digit 2)	Common Cathode (Digit 2)
14.	Common Anode (Digit 1)	Common Anode (Digit 1)	Common Cathode (Digit 1)	Common Cathode (Digit 1)
15.	Cathode B (Digit 1)	Cathode B (Digit 1)	Anode B (Digit 1)	Anode B (Digit 1)
16.	No Connection	No Connection	Anode A (Digit 1)	No Connection
17.	Cathode G (Digit 1)	No Connection	Anode G (Digit 1)	No Connection
18.	Cathode F (Digit 1)	No Connection	Anode F (Digit 1)	No Connection

Pin No.	Connection	
	I.LTC-561	J.LTC-571
1.	Cathode E	Anode E
2.	Cathode D	Anode D
3.	Cathode D.P.	Anode D.P.
4.	Cathode C	Anode C
5.	Cathode G	Anode G
6.	No Connection	No Connection
7.	Cathode B	Anode B
8.	Common Anode, Digit 3	Common Cathode, Digit 3
9.	Common Anode, Digit 2	Common Cathode, Digit 2
10.	Cathode F	Anode F
11.	Cathode A	Anode A
12.	Common Anode, Digit 1	Common Cathode, Digit 1

Pin No.	Connection	
	K.LTC-5623	L.LTC-5723
1.	Cathode E	Anode E
2.	Cathode D	Anode D
3.	Cathode D.P.	Anode D.P.
4.	Cathode C	Anode C
5.	Cathode G	Anode G
6.	Common Anode, Digit 4	Common Cathode Digit 4
7.	Cathode B	Anode B
8.	Common Anode, Digit 3	Common Cathode, Digit 3
9.	Common Anode, Digit 2	Common Cathode, Digit 2
10.	Cathode F	Anode F
11.	Cathode A	Anode A
12.	Common Anode, Digit 1	Common Cathode, Digit 1

## Internal Circuit Diagrams

A.LTS-6x60

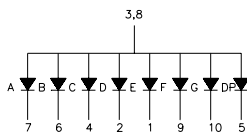

B.LTS-6x80

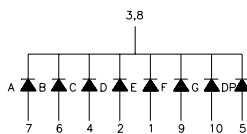

C.LTS-6x75

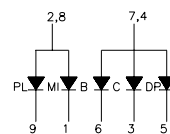

D.LTS-6x95

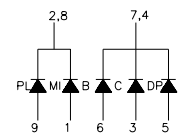

E.LTD-6x10

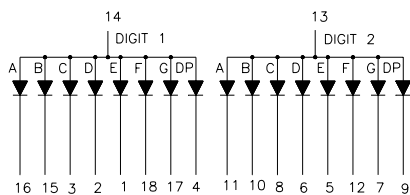

F.LTD-6x30

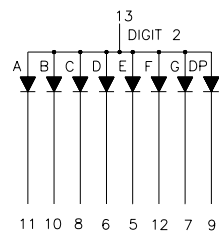
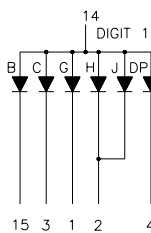

G.LTD-6x40

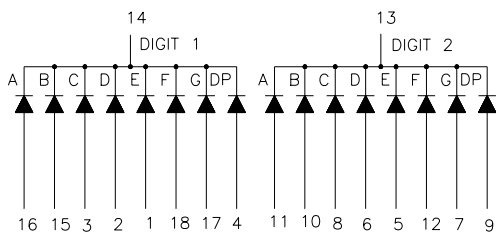

H.LTD-6x50

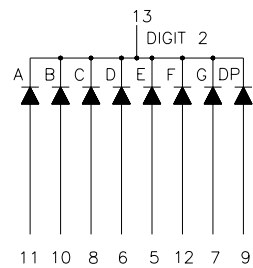
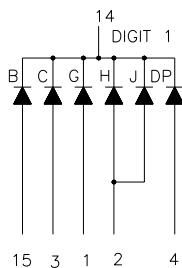

**I.LTC-561**

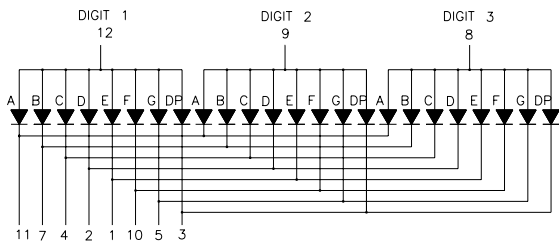

**J.LTC-571**

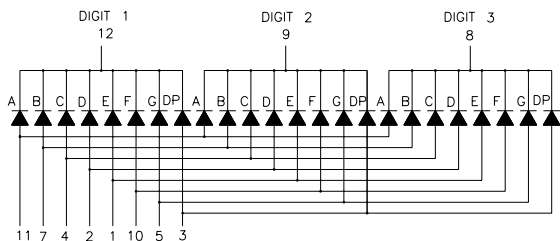

**K.LTC-5623**

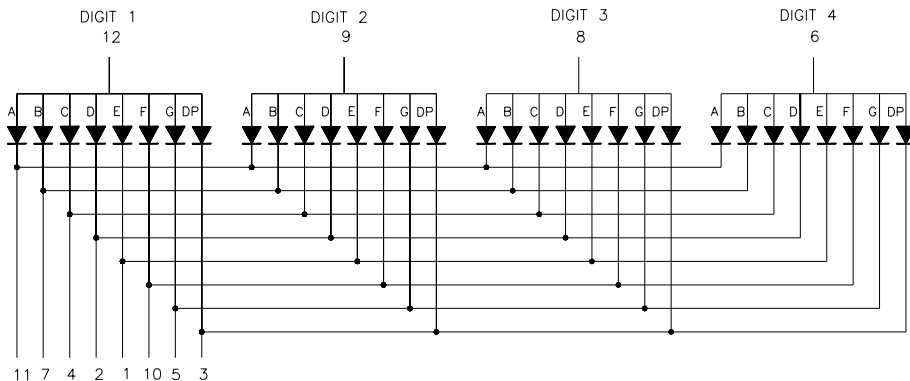

**L.LTC-5723**

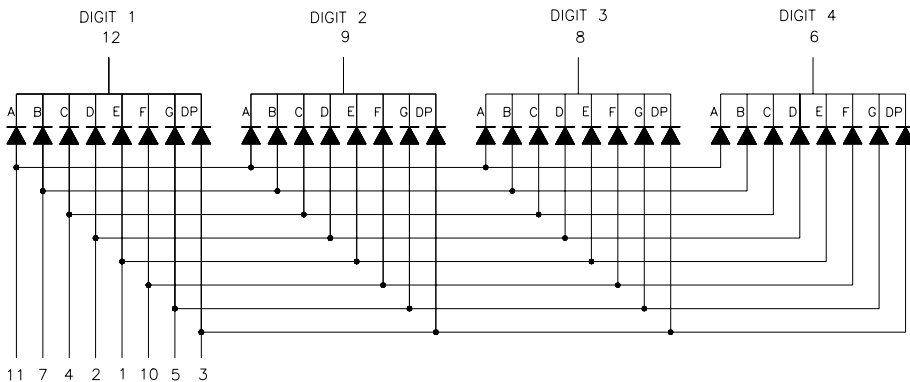

**Absolute Maximum Rating at Ta=25°C**

Parameter	AlGaAs Red	Bright Red	Green	Yellow	Red Orange	Hi. -Eff. Red	Unit
Power Dissipation Per Segment	75	40	75	60	75	75	mW
Peak Forward Current Per Segment (1/10 Duty Cycle, 0.1ms Pulse Width)	125	60	100	80	100	100	mA
Continuous Forward Current Per Segment Derating Linear from 25°C Per Segment	30	15	25	20	25	25	mA
	0.4	0.2	0.33	0.27	0.33	0.33	mA/°C
Reverse Voltage Per Segment	5	5	5	5	5	5	V
Operating Temperature Range	-35°C to +85°C						
Storage Temperature Range	-35°C to +85°C						
Solder Temperature 1/16 Inch Below Seating Plane for 3 Seconds at 260°C							

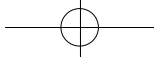

## Electrical/Optical Characteristics at Ta=25°C

LTS-6760WC/6780WC/6775WC/6795WC/LTD-6710WC/6730WC/6740WC/6750WC/LTC-561WC/571WC/5623WC/5723WC

Parameter	Symbol	Min.	Typ.	Max.	Unit	Tset Condition
Average Luminous Intensity	I <sub>v</sub>	320	700		μ cd	I <sub>F</sub> =1mA
			3750			I <sub>F</sub> =5mA
Peak Emission Wavelength	λ P		660		nm	I <sub>F</sub> =20mA
Spectral Line Half-Width	Δ λ		35		nm	I <sub>F</sub> =20mA
Dominant Wavelength	λ d		638		nm	I <sub>F</sub> =20mA
Forward Voltage, Per Segment	V <sub>F</sub>		1.6	2.4	V	I <sub>F</sub> =1mA
			1.7			I <sub>F</sub> =5mA
			1.8			I <sub>F</sub> =20mA
Reverse Current, Per Segment	I <sub>R</sub>			100	μ A	V <sub>R</sub> =5V
Luminous Intensity Matching Ratio	I <sub>v</sub> -m			2:1		I <sub>F</sub> =1mA

LTS-6760P/6780P/6775P/6795P/LTD-6710P/6730P/6740P/6750P/LTC-561P/571P/5623P/5723P

Parameter	Symbol	Min.	Typ.	Max.	Unit	Tset Condition
Average Luminous Intensity	I <sub>v</sub>	320	950		μ cd	I <sub>F</sub> =10mA
Peak Emission Wavelength	λ P		697		nm	I <sub>F</sub> =20mA
Spectral Line Half-Width	Δ λ		90		nm	I <sub>F</sub> =20mA
Dominant Wavelength	λ d		657		nm	I <sub>F</sub> =20mA
Forward Voltage, Per Segment or D.P.	V <sub>F</sub>		2.1	2.6	V	I <sub>F</sub> =20mA
Reverse Current, Per Segment or D.P.	I <sub>R</sub>			100	μ A	V <sub>R</sub> =5V
Luminous Intensity Matching Ratio	I <sub>v</sub> -m			2:1		I <sub>F</sub> =10mA

LTS-6460G/6480G/6475G/6495G/LTD-6410G/6430G/6440G/6450G/LTC-561G/571G/5623G/5723G

Parameter	Symbol	Min.	Typ.	Max.	Unit	Tset Condition
Average Luminous Intensity	I <sub>v</sub>	800	2400		μ cd	I <sub>F</sub> =10mA
Peak Emission Wavelength	λ P		565		nm	I <sub>F</sub> =20mA
Spectral Line Half-Width	Δ λ		30		nm	I <sub>F</sub> =20mA
Dominant Wavelength	λ d		569		nm	I <sub>F</sub> =20mA
Forward Voltage, Per Segment or D.P.	V <sub>F</sub>		2.1	2.6	V	I <sub>F</sub> =20mA
Reverse Current, Per Segment or D.P.	I <sub>R</sub>			100	μ A	V <sub>R</sub> =5V
Luminous Intensity Matching Ratio	I <sub>v</sub> -m			2:1		I <sub>F</sub> =10mA

LTS-6860Y/6880Y/6875Y/6895Y/LTD-6810Y/6830Y/6840Y/6850Y/LTC-561Y/571Y/5623Y/5723Y

Parameter	Symbol	Min.	Typ.	Max.	Unit	Tset Condition
Average Luminous Intensity	I <sub>v</sub>	800	2400		μ cd	I <sub>F</sub> =10mA
Peak Emission Wavelength	λ P		585		nm	I <sub>F</sub> =20mA
Spectral Line Half-Width	Δ λ		35		nm	I <sub>F</sub> =20mA
Dominant Wavelength	λ d		588		nm	I <sub>F</sub> =20mA
Forward Voltage, Per Segment or D.P.	V <sub>F</sub>		2.1	2.6	V	I <sub>F</sub> =20mA
Reverse Current, Per Segment or D.P.	I <sub>R</sub>			100	μ A	V <sub>R</sub> =5V
Luminous Intensity Matching Ratio	I <sub>v</sub> -m			2:1		I <sub>F</sub> =10mA

LTS-6660E/6680E/6675E/6695E/LTD-6610E/6630E/6640E/6650E/LTC-561E/571E/5623E/5723E

Parameter	Symbol	Min.	Typ.	Max.	Unit	Tset Condition
Average Luminous Intensity	I <sub>v</sub>	800	2400		μ cd	I <sub>F</sub> =10mA
Peak Emission Wavelength	λ P		630		nm	I <sub>F</sub> =20mA
Spectral Line Half-Width	Δ λ		40		nm	I <sub>F</sub> =20mA
Dominant Wavelength	λ d		621		nm	I <sub>F</sub> =20mA
Forward Voltage, Per Segment or D.P.	V <sub>F</sub>		2.0	2.6	V	I <sub>F</sub> =20mA
Reverse Current, Per Segment or D.P.	I <sub>R</sub>			100	μ A	V <sub>R</sub> =5V
Luminous Intensity Matching Ratio	I <sub>v</sub> -m			2:1		I <sub>F</sub> =10mA

9-162

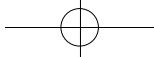

LTS-6960HR/6980HR/6975HR/6995HR/LTD-6910HR/6930HR/6940HR/6950HR/LTC-561HR/571HR/5623HR/5723HR

Parameter	Symbol	Min.	Typ.	Max.	Unit	Tset Condition
Average Luminous Intensity	I <sub>v</sub>	800	2400		μ cd	I <sub>F</sub> =10mA
Peak Emission Wavelength	λ <sub>P</sub>		635		nm	I <sub>F</sub> =20mA
Spectral Line Half-Width	Δλ		40		nm	I <sub>F</sub> =20mA
Dominant Wavelength	λ <sub>d</sub>		623		nm	I <sub>F</sub> =20mA
Forward Voltage, Per Segment	V <sub>F</sub>		2.0	2.6	V	I <sub>F</sub> =20mA
Reverse Current, Per Segment	I <sub>R</sub>			100	μ A	V <sub>R</sub> =5V
Luminous Intensity Matching Ratio	I <sub>v</sub> -m			2:1		I <sub>F</sub> =10mA

Note: Luminous intensity is measured with a light sensor and filter combination that approximates the CIE (Commission Internationale De L'Eclairage) eye-response curve.

## Typical Electrical/Optical Characteristic Curves (25°C Ambient Temperature Unless Otherwise Noted)

DISPLAYS

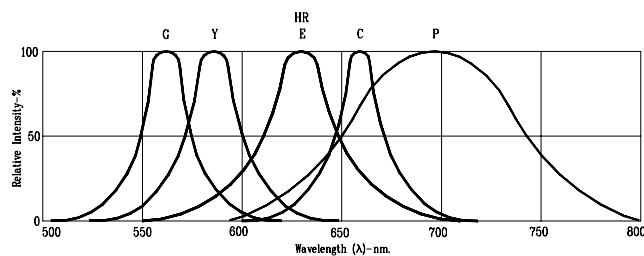

Fig1. RELATIVE INTENSITY VS. WAVELENGTH

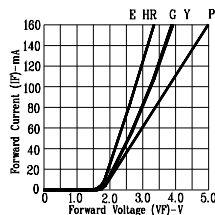

Fig2. FORWARD CURRENT VS. FORWARD VOLTAGE

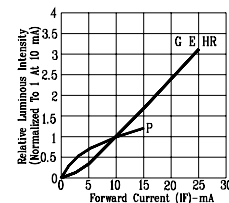

Fig3. RELATIVE LUMINOUS INTENSITY VS. FORWARD CURRENT

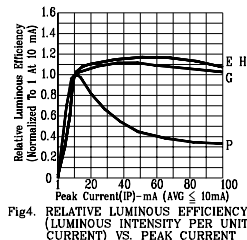

Fig4. RELATIVE LUMINOUS EFFICIENCY (LUMINOUS INTENSITY PER UNIT CURRENT) VS. PEAK CURRENT

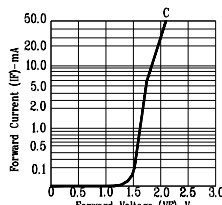

Fig5. FORWARD CURRENT VS. FORWARD VOLTAGE

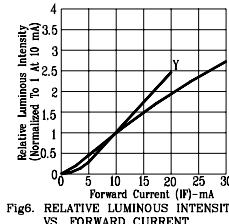

Fig6. RELATIVE LUMINOUS INTENSITY VS. FORWARD CURRENT

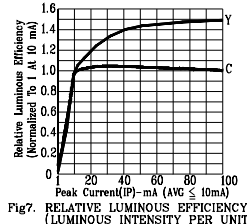

Fig7. RELATIVE LUMINOUS EFFICIENCY (LUMINOUS INTENSITY PER UNIT CURRENT) VS. PEAK CURRENT

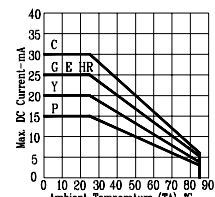

Fig8. MAX ALLOWABLE DC CURRENT VS. AMBIENT TEMPERATURE.

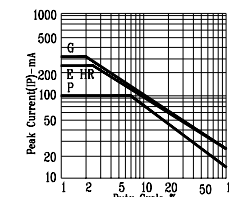

Fig9. MAX PEAK CURRENT VS. DUTY CYCLE % (REFRESH RATE 1KHz)

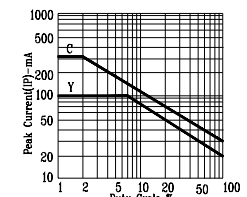

Fig10. MAX PEAK CURRENT VS. DUTY CYCLE % (REFRESH RATE 1KHz)

NOTE: C=GREEN Y=YELLOW HR=Hi-Eff. RED E=RED ORANGE C=AlGaAs RED P=BRIGHT RED (REFRESH RATE 1KHz)