



2SA1627A

PNP SILICON TRANSISTOR

PNP EPITAXIAL SILICON TRANSISTOR

DESCRIPTION

The UTC **2SA1627A** is designed for general purpose amplifier and high speed switching applications.

FEATURES

- * High voltage
- * Low collector saturation voltage.
- * High-speed switching

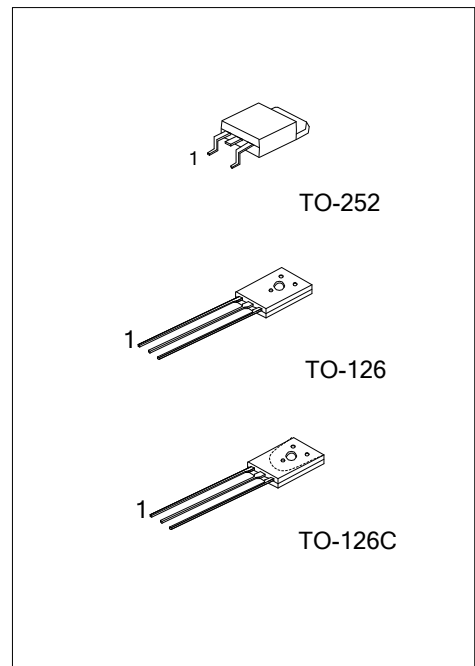

ORDERING INFORMATION

Ordering Number		Package	Pin Assignment			Packing
Lead Free	Halogen Free		1	2	3	
2SA1627AL-x-T60-K	2SA1627AG-x-T60-K	TO-126	E	C	B	Bulk
2SA1627AL-x-T6C-K	2SA1627AG-x-T6C-K	TO-126C	E	C	B	Bulk
2SA1627AL-x-TN3-R	2SA1627AG-x-TN3-R	TO-252	B	C	E	Tape Reel
2SA1627AL-x-TN3-T	2SA1627AG-x-TN3-T	TO-252	B	C	E	Tube

<p>2SA1627AL-x-T6C-K</p> <p>(1)Packing Type (2)Package Type (3)Rank (4)Lead Free</p>	<p>(1) K: Bulk, R: Tape Reel, T: Tube (2) T6C: TO-126C, T60: TO-126, TN3: TO-252 (3) x: reference to Classification of h_{FE1} (4) Halogen Free, L: Lead Free</p>
--	--

2SA1627A

PNP SILICON TRANSISTOR

■ ABSOLUTE MAXIMUM RATINGS ($T_A=25^{\circ}\text{C}$, unless otherwise specified)

PARAMETER		SYMBOL	RATINGS	UNIT
Collector-Base Voltage		V_{CBO}	-600	V
Collector-Emitter Voltage		V_{CEO}	-600	V
Emitter-Base Voltage		V_{EBO}	-7.0	V
Collector Power Dissipation	TO-126/TO-126C	P_C	1.0	W
	TO-252		1.9	
Collector Current (DC)		I_C	-1.0	A
Collector Current (Pulse) (Note 2)		I_{CP}	-2.0	A
Junction Temperature		T_J	150	$^{\circ}\text{C}$
Storage Temperature		T_{STG}	-55 ~ +150	$^{\circ}\text{C}$

Notes: 1. Absolute maximum ratings are those values beyond which the device could be permanently damaged.

Absolute maximum ratings are stress ratings only and functional device operation is not implied.

2. $PW \leq 10\text{ms}$, Duty Cycle $\leq 50\%$

■ ELECTRICAL CHARACTERISTICS ($T_A=25^{\circ}\text{C}$, unless otherwise specified)

PARAMETER	SYMBOL	TEST CONDITIONS	MIN	TYP	MAX	UNIT
Collector Cut-Off Current	I_{CBO}	$V_{CB} = -600\text{V}$, $I_E = 0$			-10	μA
Emitter Cut-Off Current	I_{EBO}	$V_{EB} = -7.0\text{V}$, $I_C = 0$			-10	μA
DC Current Gain (Note 2)	h_{FE1}	$V_{CE} = -5.0\text{V}$, $I_C = -0.1\text{A}$	30	58	120	
	h_{FE2}	$V_{CE} = -5.0\text{V}$, $I_C = -0.5\text{A}$	4	19		
Collector-Emitter Saturation Voltage(Note)	$V_{CE(SAT)}$	$I_C = -0.3\text{A}$, $I_B = -0.06\text{A}$		-0.28	-1.5	V
Base-Emitter Saturation Voltage(Note)	$V_{BE(SAT)}$	$I_C = -0.3\text{A}$, $I_B = -0.06\text{A}$		-0.85	-1.2	V
Gain Bandwidth Product	f_T	$V_{CE} = -10\text{V}$, $I_E = 0.1\text{A}$	10	28		MHz
Output Capacitance	C_{OB}	$V_{CB} = -10\text{V}$, $I_E = 0$, $f = 1.0\text{MHz}$		42	50	pF
Turn-On Time	t_{ON}	$I_C = -0.5\text{A}$, $R_L = 500\Omega$, $I_{B1} = -I_{B2} = -0.1\text{A}$, $V_{CC} = -250\text{V}$		0.1	0.5	μs
Storage Time	T_{SYG}			3.5	5.0	μs
Fall Time	t_F			0.08	0.5	μs

Note: Pulsed $PW \leq 350\mu\text{s}$, Duty Cycle $\leq 2\%$

■ CLASSIFICATION OF h_{FE1}

RANK	M	L	K
RANGE	30-60	40-80	60-120

TYPICAL CHARACTERISTICS

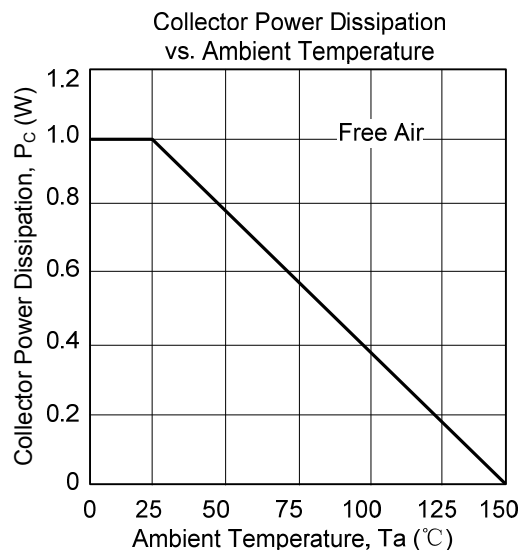
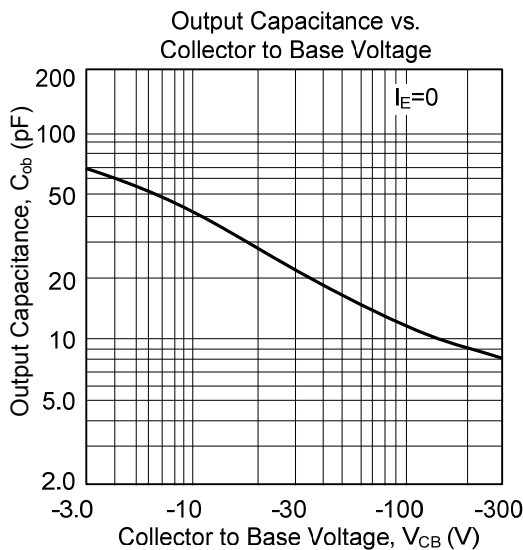
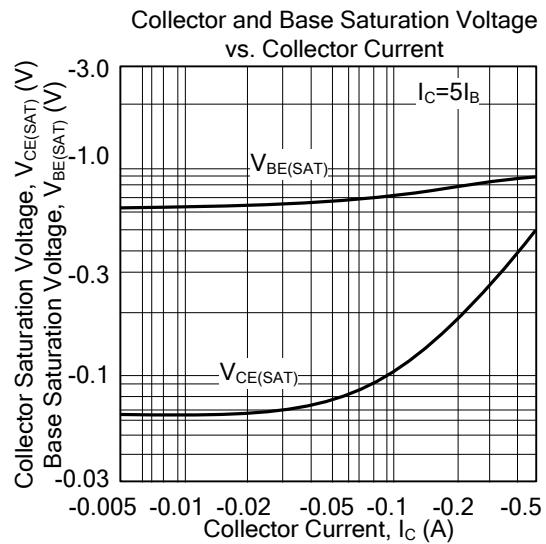
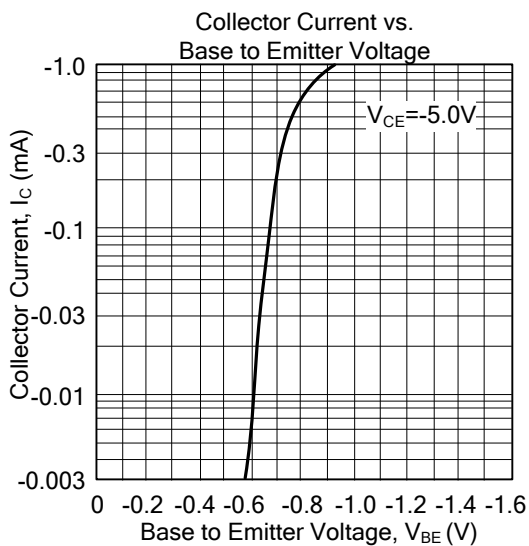
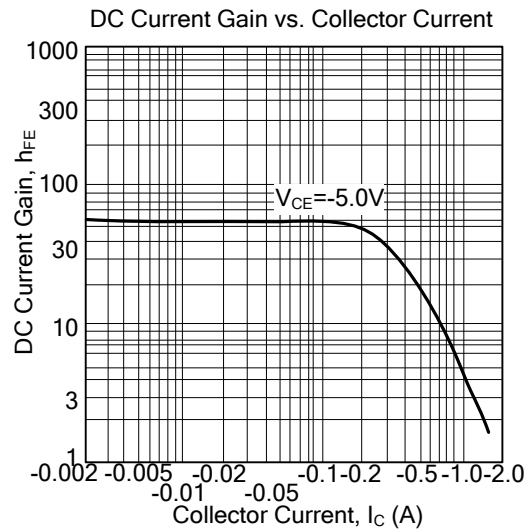
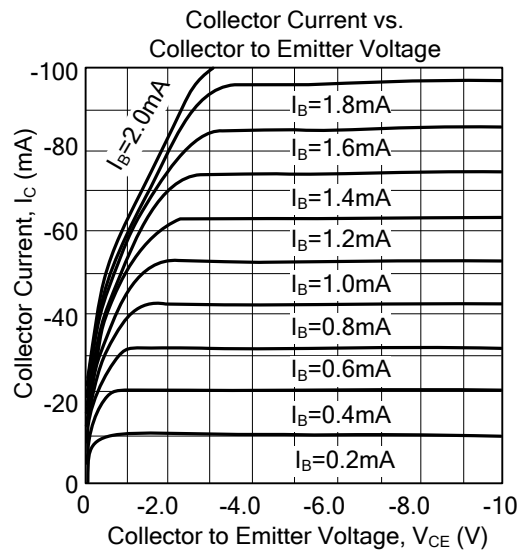

■ TYPICAL CHARACTERISTICS(Cont.)

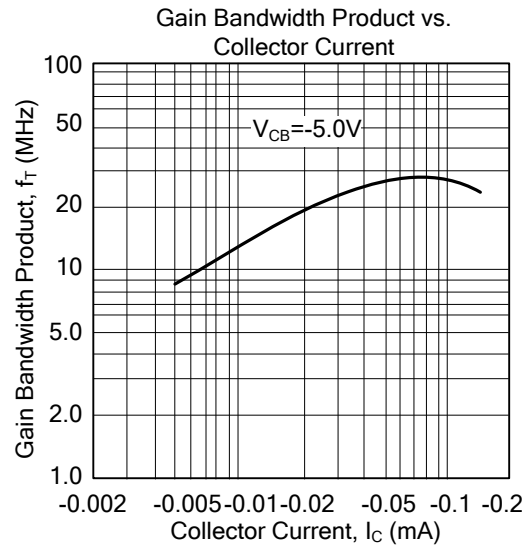
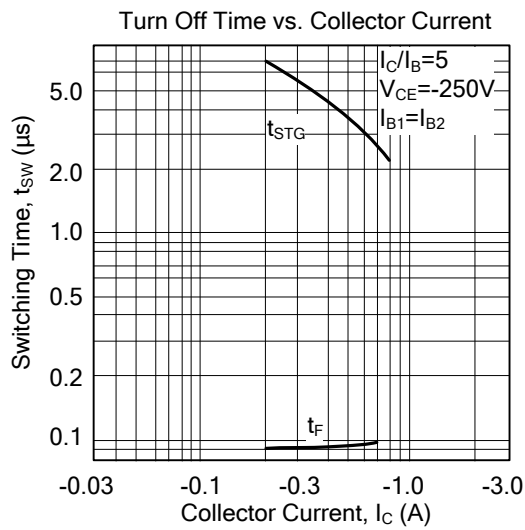

UTC assumes no responsibility for equipment failures that result from using products at values that exceed, even momentarily, rated values (such as maximum ratings, operating condition ranges, or other parameters) listed in products specifications of any and all UTC products described or contained herein. UTC products are not designed for use in life support appliances, devices or systems where malfunction of these products can be reasonably expected to result in personal injury. Reproduction in whole or in part is prohibited without the prior written consent of the copyright owner. The information presented in this document does not form part of any quotation or contract, is believed to be accurate and reliable and may be changed without notice.