

# DELPHI SERIES



## FEATURES

- ◆ High efficiency: 84% @ 1.2V/ 12A
- ◆ Size: 47.2mm x 29.5mm x 8.35mm  
(1.86" x 1.16" x 0.33")
- ◆ Low profile: 0.33"
- ◆ Industry standard footprint and pin out
- ◆ Surface mountable
- ◆ Fixed frequency operation
- ◆ Input UVLO, Output OCP, OVP
- ◆ No minimum load required
- ◆ 2:1 input voltage range
- ◆ Basic insulation
- ◆ ISO 9001, TL 9000, ISO 14001, QS9000, OHSAS18001 certified manufacturing facility
- ◆ UL/cUL 60950 (US & Canada) recognized, and TUV (EN60950) certified
- ◆ CE mark meets 73/23/EEC and 93/68/EEC directive

## Delphi Series S48SA, 33W Family DC/DC Power Modules: 48V in, 1.2V/12A out

The Delphi Series S48SA, surface mountable, 48V input, single output, isolated DC/DC converters are the latest offering from a world leader in power system and technology and manufacturing – Delta Electronics, Inc. This product family provides up to 33 watts of power or up to 12A of output current (1.8V or below). With creative design technology and optimization of component placement, these converters possess outstanding electrical and thermal performance, as well as extremely high reliability under highly stressful operating conditions. All models are protected from abnormal input/output voltage and current conditions.

## OPTIONS

- ◆ Positive on/off logic
- ◆ SMD or Through hole mounting

## APPLICATIONS

- ◆ Telecom/DataCom
- ◆ Wireless Networks
- ◆ Optical Network Equipment
- ◆ Server and Data Storage
- ◆ Industrial/Test Equipment

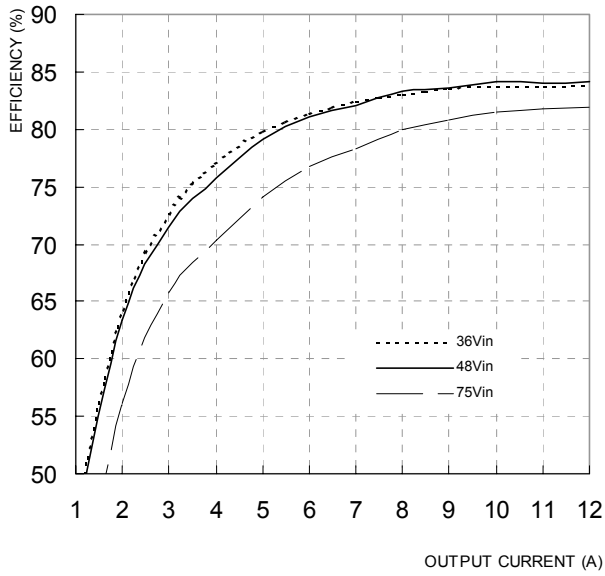
# TECHNICAL SPECIFICATIONS

( $T_A=25^{\circ}\text{C}$ , airflow rate=300 LFM,  $V_{in}=48\text{Vdc}$ , nominal  $V_{out}$  unless otherwise noted)

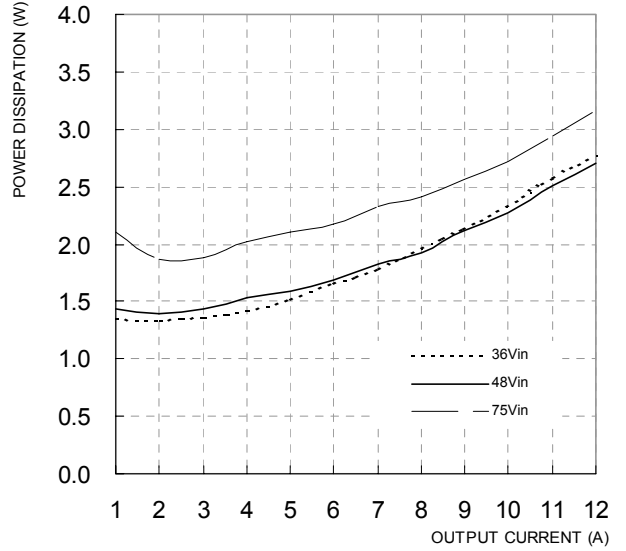
PARAMETER	NOTES and CONDITIONS	S48SA1R212NRFA			
		Min.	Typ.	Max.	Units
<b>ABSOLUTE MAXIMUM RATINGS</b>					
Input Voltage					
Continuous				80	Vdc
Transient (100ms)	100ms			100	Vdc
Operating Temperature	Refer to Figure 18 for measuring point	-40		102	$^{\circ}\text{C}$
Storage Temperature		-55		125	$^{\circ}\text{C}$
Input/Output Isolation Voltage	1 minute	1500			Vdc
<b>INPUT CHARACTERISTICS</b>					
Operating Input Voltage		36	48	75	V
Input Under-Voltage Lockout					
Turn-On Voltage Threshold		32.5	34	35.5	V
Turn-Off Voltage Threshold		30.5	32	33.5	V
Lockout Hysteresis Voltage		1	2	3	V
Maximum Input Current	100% Load, 36Vin			0.85	A
No-Load Input Current			35		mA
Off Converter Input Current			7		mA
Inrush Current ( $I^t$ )			0.01		$\text{A}^2\text{s}$
Input Reflected-Ripple Current	P-P thru 12 $\mu\text{H}$ inductor, 5Hz to 20MHz		5		mA
Input Voltage Ripple Rejection	120 Hz		50		dB
<b>OUTPUT CHARACTERISTICS</b>					
Output Voltage Set Point	$V_{in}=48\text{V}$ , $I_o=50\%I_{o,max}$ , $T_a=25^{\circ}\text{C}$	1.17	1.20	1.23	V
Output Voltage Regulation					
Over Load	$I_o=I_{o,min}$ to $I_{o,max}$		$\pm 2$	$\pm 10$	mV
Over Line	$V_{in}=36\text{V}$ to $75\text{V}$		$\pm 2$	$\pm 5$	mV
Over Temperature	$T_a=40^{\circ}\text{C}$ to $85^{\circ}\text{C}$		100	300	ppm/ $^{\circ}\text{C}$
Total Output Voltage Range	Over sample load, line and temperature	1.15		1.25	V
Output Voltage Ripple and Noise	5Hz to 20MHz bandwidth				
Peak-to-Peak	Full Load, 1 $\mu\text{F}$ ceramic, 10 $\mu\text{F}$ tantalum		30	75	mV
RMS	Full Load, 1 $\mu\text{F}$ ceramic, 10 $\mu\text{F}$ tantalum		5	20	mV
Operating Output Current Range		0		12	A
Output DC Current-Limit Inception	Output Voltage 10% Low	13.2	15.6	18	A
<b>DYNAMIC CHARACTERISTICS</b>					
Output Voltage Current Transient	48V, 10 $\mu\text{F}$ Tan & 1 $\mu\text{F}$ Ceramic load cap, 0.1A/ $\mu\text{s}$				
Positive Step Change in Output Current	50% $I_{o,max}$ to 75% $I_{o,max}$		35	100	mV
Negative Step Change in Output Current	75% $I_{o,max}$ to 50% $I_{o,max}$		35	100	mV
Settling Time to 1% of Final value			200		$\mu\text{s}$
Turn-On Transient					
Start-Up Time, From On/Off Control			6	12	ms
Start-Up Time, From Input			6	12	ms
Maximum Output Capacitance	Full load; 5% overshoot of $V_{out}$ at startup			2200	$\mu\text{F}$
<b>EFFICIENCY</b>					
100% Load		82	84		%
<b>ISOLATION CHARACTERISTICS</b>					
Isolation Voltage		1500			V
Isolation Resistance		10			$\text{M}\Omega$
Isolation Capacitance			1500		pF
<b>FEATURE CHARACTERISTICS</b>					
Switching Frequency			330		kHz
ON/OFF Control, (Logic Low-Module ON)					
Logic Low	$V_{on/off}$ at $I_{on/off}=1.0\text{mA}$	0		0.8	V
Logic High	$V_{on/off}$ at $I_{on/off}=0.0\mu\text{A}$			15	V
ON/OFF Current	$I_{on/off}$ at $V_{on/off}=0.0\text{V}$			1	mA
Leakage Current	Logic High, $V_{on/off}=15\text{V}$			50	$\mu\text{A}$
Output Voltage Trim Range	Across Trim Pin & +Vo or -Vo, $P_{out} \leq \text{max rated}$	-10		+10	%
Output Over-Voltage Protection (Hiccup)	Over full temp range; % of nominal $V_{out}$	115	125	160	%
<b>GENERAL SPECIFICATIONS</b>					
Calculated MTBF	$I_o=80\%$ of $I_{o,max}$ ; $T_c=40^{\circ}\text{C}$		TBD		hours
Weight			18		grams
Over-Temperature Shutdown	Refer to Figure 18 for measuring point		115		$^{\circ}\text{C}$



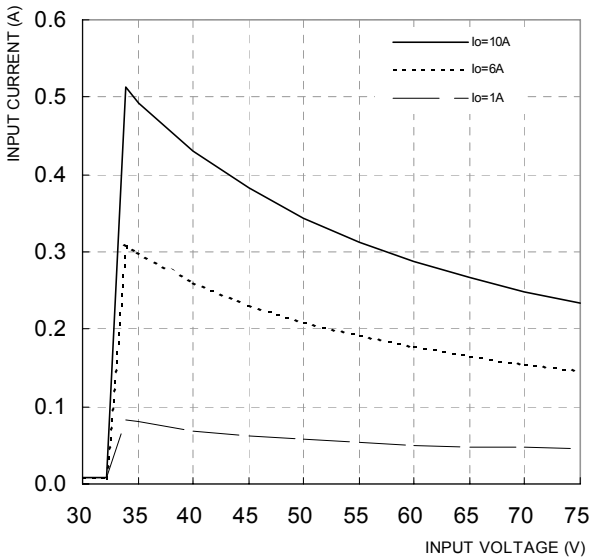
# ELECTRICAL CHARACTERISTICS CURVES



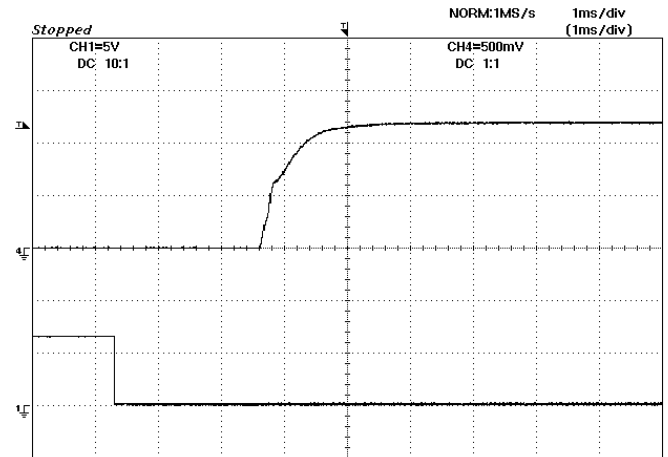
**Figure 1:** Efficiency vs. load current for minimum, nominal, and maximum input voltage at 25°C.



**Figure 2:** Power dissipation vs. load current for minimum, nominal, and maximum input voltage at 25°C.

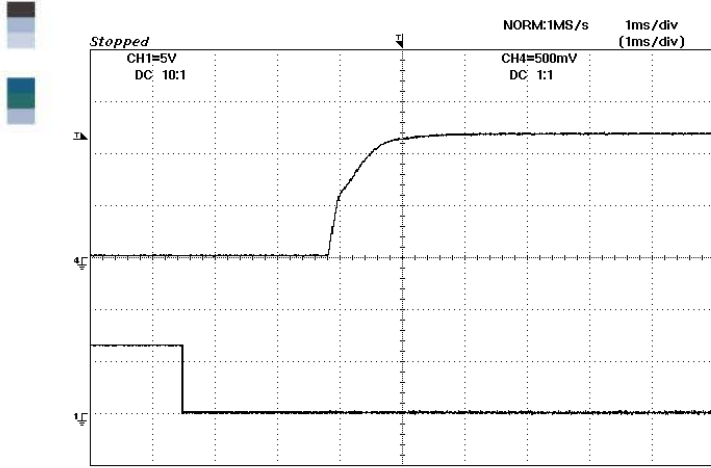


**Figure 3:** Typical input characteristics at room temperature.

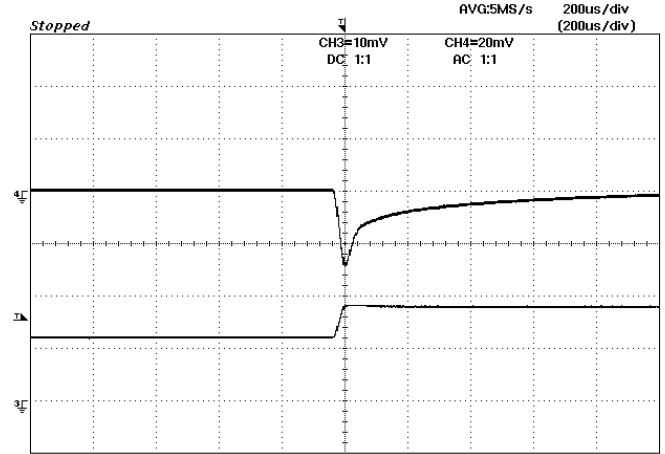


**Figure 4:** Turn-on transient at full rated load current (1 ms/div). Top Trace: Vout (500mV/div); Bottom Trace: ON/OFF Control (5V/div).

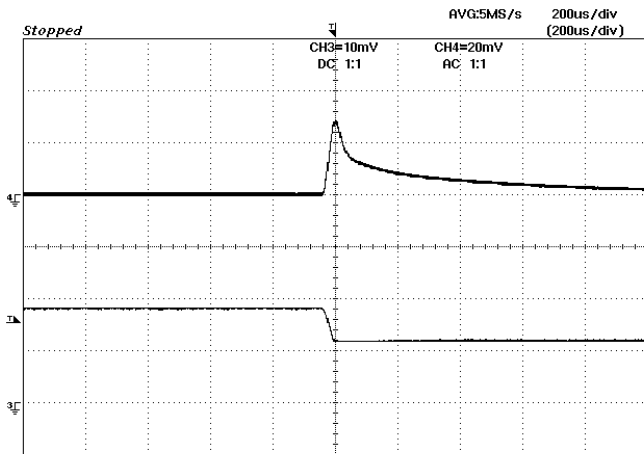
# ELECTRICAL CHARACTERISTICS CURVES



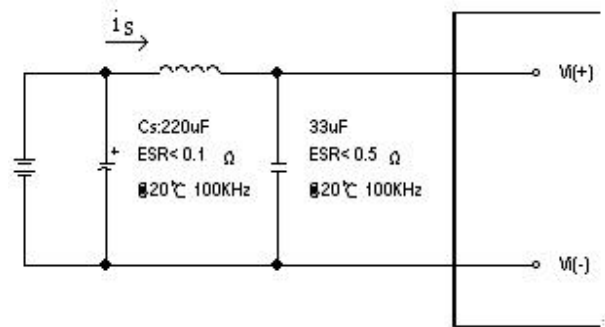
**Figure 5:** Turn-on transient at zero load current (1 ms/div). Top Trace: Vout (500mV/div); Bottom Trace: ON/OFF Control (5V/div).



**Figure 6:** Output voltage response to step-change in load current (50%-75% of Io, max; di/dt = 0.1A/μs). Load cap: 10μF, 100 mΩ ESR tantalum capacitor and 1μF ceramic capacitor. Top Trace: Vout (20mV/div), Bottom Trace: Iout (5A/div).

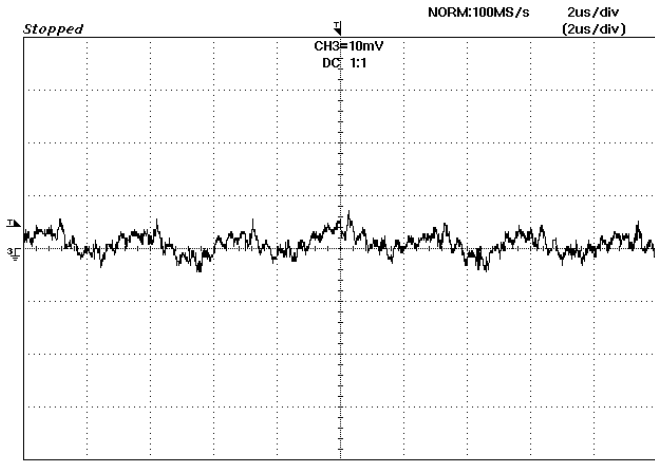


**Figure 7:** Output voltage response to step-change in load current (75%-50% of Io, max; di/dt = 0.1A/μs). Load cap: 10μF, 100 mΩ ESR tantalum capacitor and 1μF ceramic capacitor. Top Trace: Vout (20mV/div), Bottom Trace: Iout 5A/div).

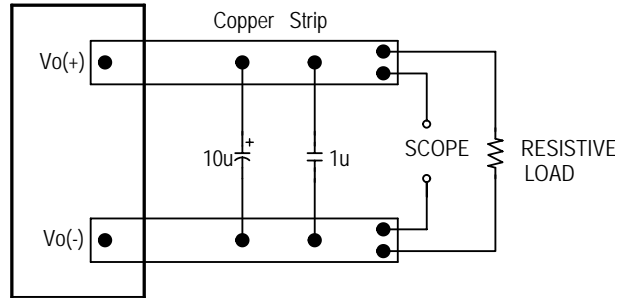


**Figure 8:** Test set-up diagram showing measurement points for Input Reflected Ripple Current (Figure 9). Note: Measured input reflected-ripple current with a simulated source Inductance ( $L_{TEST}$ ) of 12 μH. Capacitor Cs offset possible battery impedance.

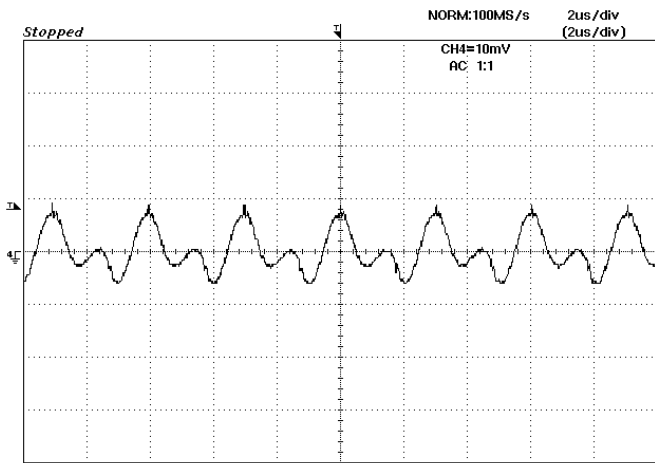
# ELECTRICAL CHARACTERISTICS CURVES



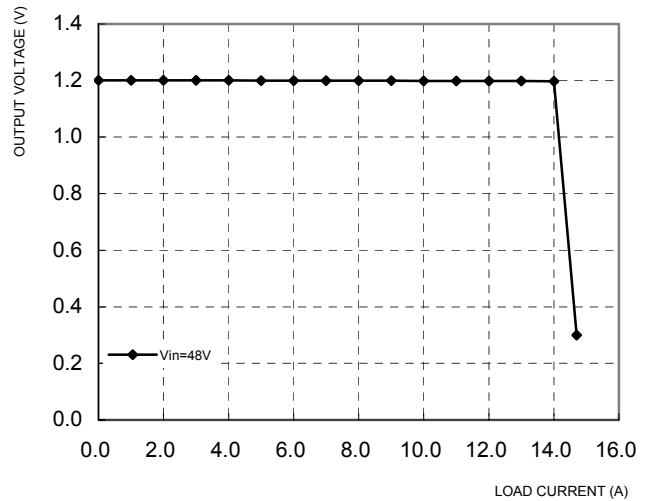
**Figure 9:** Input Reflected Ripple Current,  $i_s$ , at full rated output current and nominal input voltage with  $12\mu\text{H}$  source impedance and  $33\mu\text{F}$  electrolytic capacitor (2 mA/div).



**Figure 10:** Output voltage noise and ripple measurement test setup. Scope measurement should be made using a BNC cable (length shorter than 20 inches). Position the load between 51 mm to 76 mm (2 inches to 3 inches) from the module.



**Figure 11:** Output voltage ripple at nominal input voltage and rated load current (10 mV/div). Load capacitance:  $1\mu\text{F}$  ceramic capacitor and  $10\mu\text{F}$  tantalum capacitor. Bandwidth: 20 MHz.



**Figure 12:** Output voltage vs. load current showing typical current limit curves and converter shutdown points.

## DESIGN CONSIDERATIONS

### Input Source Impedance

The impedance of the input source connecting to the DC/DC power modules will interact with the modules and affect the stability. A low ac-impedance input source is recommended. If the source inductance is more than a few  $\mu\text{H}$ , we advise adding a 10 to 100  $\mu\text{F}$  electrolytic capacitor ( $\text{ESR} < 0.7 \Omega$  at 100 kHz) mounted close to the input of the module to improve the stability.

### Layout and EMC Considerations

Delta's DC/DC power modules are designed to operate in a wide variety of systems and applications. For design assistance with EMC compliance and related PWB layout issues, please contact Delta's technical support team. An external input filter module is available for easier EMC compliance design. Application notes to assist designers in addressing these issues are pending release.

### Safety Considerations

The power module must be installed in compliance with the spacing and separation requirements of the end-user's safety agency standard if the system in which the power module is to be used must meet safety agency requirements.

When the input source is 60Vdc or below, the power module meets SELV (safety extra-low voltage) requirements. If the input source is a hazardous voltage which is greater than 60 Vdc and less than or equal to 75 Vdc, for the module's output to meet SELV requirements, all of the following must be met:

- The input source must be insulated from any hazardous voltages, including the ac mains, with reinforced insulation.
- One  $V_i$  pin and one  $V_o$  pin are grounded, or all the input and output pins are kept floating.
- The input terminals of the module are not operator accessible.
- A SELV reliability test is conducted on the system where the module is used to ensure that under a single fault, hazardous voltage does not appear at the module's output.

Do not ground one of the input pins without grounding one of the output pins. This connection may allow a non-SELV voltage to appear between the output pin and ground.

This power module is not internally fused. To achieve optimum safety and system protection, an input line fuse is highly recommended. The safety agencies require a normal-blow fuse with 3A maximum rating to be installed in the ungrounded lead. A lower rated fuse can be used based on the maximum inrush transient energy and maximum input current.

### Soldering and Cleaning Considerations

Post solder cleaning is usually the final board assembly process before the board or system undergoes electrical testing. Inadequate cleaning and/or drying may lower the reliability of a power module and severely affect the finished circuit board assembly test. Adequate cleaning and/or drying is especially important for un-encapsulated and/or open frame type power modules. For assistance on appropriate soldering and cleaning procedures, please contact Delta's technical support team.

## FEATURES DESCRIPTIONS

### Over-Current Protection

The modules include an internal output over-current protection circuit, which will endure current limiting for an unlimited duration during output overload. If the output current exceeds the OCP set point, the modules will automatically shut down (hiccup mode).

The modules will try to restart after shutdown. If the overload condition still exists, the module will shut down again. This restart trial will continue until the overload condition is corrected.

### Over-Voltage Protection

The modules include an internal output over-voltage protection circuit, which monitors the voltage on the output terminals. If this voltage exceeds the over-voltage set point, the module will shut down (Hiccup mode). The modules will try to restart after shutdown. If the fault condition still exists, the module will shut down again. This restart trial will continue until the fault condition is corrected.

### Over-Temperature Protection

The over-temperature protection consists of circuitry that provides protection from thermal damage. If the temperature exceeds the over-temperature threshold the module will shut down.

The module will try to restart after shutdown. If the over-temperature condition still exists during restart, the module will shut down again. This restart trial will continue until the temperature is within specification.

### Remote On/Off

The remote on/off feature on the module can be either negative or positive logic. Negative logic turns the module on during a logic low and off during a logic high. Positive logic turns the modules on during a logic high and off during a logic low.

Remote on/off can be controlled by an external switch between the on/off terminal and the Vi(-) terminal. The switch can be an open collector or open drain.

For negative logic if the remote on/off feature is not used, please short the on/off pin to Vi(-). For positive logic if the remote on/off feature is not used, please leave the on/off pin floating.

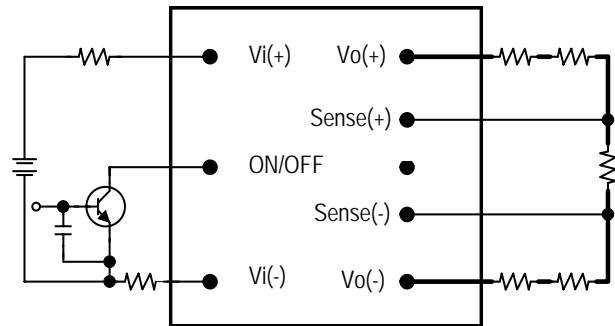


Figure 13: Remote on/off implementation

### Remote Sense (Optional)

Remote sense compensates for voltage drops on the output by sensing the actual output voltage at the point of load. The voltage between the remote sense pins and the output terminals must not exceed the output voltage sense range given here:

$$[Vo(+)-Vo(-)]-[SENSE(+)-SENSE(-)]\leq 10\%\times V_{out}$$

This limit includes any increase in voltage due to remote sense compensation and output voltage set point adjustment (trim).

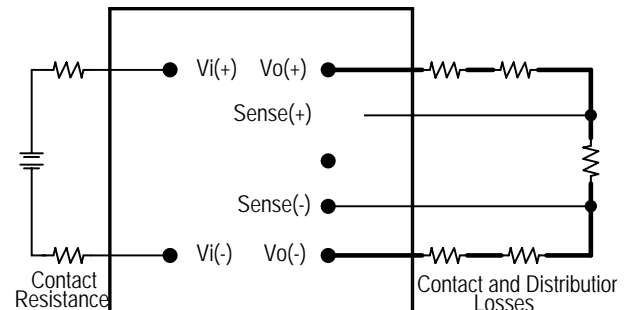


Figure 14: Effective circuit configuration for remote sense operation

If the remote sense feature is not used to regulate the output at the point of load, please connect SENSE(+) to Vo(+) and SENSE(-) to Vo(-) at the module.

The output voltage can be increased by both the remote sense and the trim; however, the maximum increase is the larger of either the remote sense or the trim, not the sum of both.

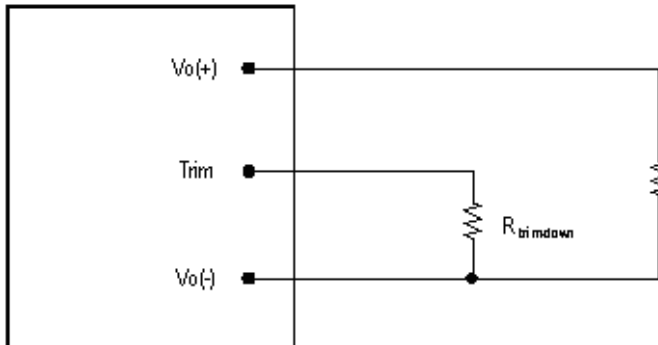
When using remote sense and trim, the output voltage of the module is usually increased, which increases the power output of the module with the same output current.

Care should be taken to ensure that the maximum output power does not exceed the maximum rated power.

## FEATURES DESCRIPTIONS (CON.)

### Output Voltage Adjustment (TRIM)

To increase or decrease the output voltage set point, the modules may be connected with an external resistor between the TRIM pin and either the Vo+ or Vo- . The TRIM pin should be left open if this feature is not used.



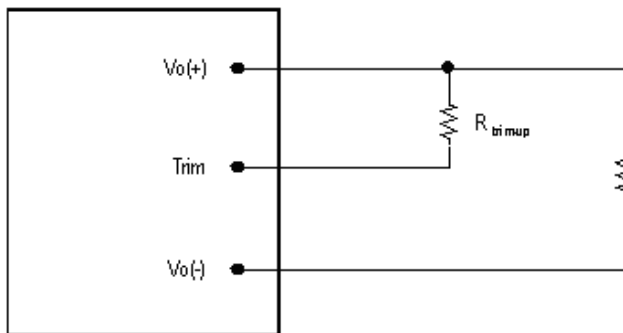
**Figure 15:** Circuit configuration for trim-down (decrease output voltage)

If the external resistor is connected between the TRIM and Vo- pins, the output voltage set point decreases. The external resistor value required to obtain a percentage of output voltage change  $\Delta Vo\%$  is defined as:

$$R_{trim-down} = \frac{1089}{\Delta Vo\%} - 62 [\text{K}\Omega]$$

Ex. When trim-down -10% ( $1.2\text{V} \times 0.9 = 1.08\text{V}$ )

$$R_{trim-down} = \frac{1089}{10} - 62 = 46.9 [\text{K}\Omega]$$



**Figure 16:** Circuit configuration for trim-up (increase output voltage)

If the external resistor is connected between the TRIM and Vo+ pins, the output voltage set point increases. The external resistor value required to obtain a

percentage output voltage change  $\Delta Vo\%$  is defined as:

$$R_{trim-up} = \frac{15.9(100 + \Delta Vo\%) - 1089}{\Delta Vo\%} - 62 [\text{K}\Omega]$$

Ex. When trim-up +10% ( $1.2\text{V} \times 1.1 = 1.32\text{V}$ )

$$R_{trim-up} = \frac{15.9(100 + 10) - 1089}{10} - 62 = 4 [\text{K}\Omega]$$

Care should be taken to ensure that the maximum output power of the module remains at or below the maximum rated power.





## THERMAL CONSIDERATIONS



Thermal management is an important part of the system design. To ensure proper, reliable operation, sufficient cooling of the power module is needed over the entire temperature range of the module. Convection cooling is usually the dominant mode of heat transfer.

Hence, the choice of equipment to characterize the thermal performance of the power module is a wind tunnel.

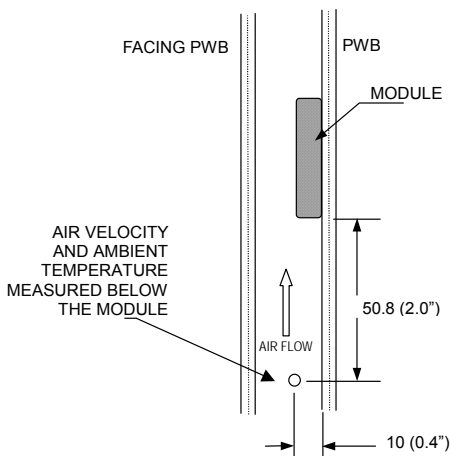
### Thermal Testing Setup

Delta's DC/DC power modules are characterized in heated vertical wind tunnels that simulate the thermal environments encountered in most electronics equipment. This type of equipment commonly uses vertically mounted circuit cards in cabinet racks in which the power modules are mounted.

The following figure shows the wind tunnel characterization setup. The power module is mounted on a test PWB and is vertically positioned within the wind tunnel. The space between the neighboring PWB and the top of the power module or a heat sink is 6.35mm (0.25").

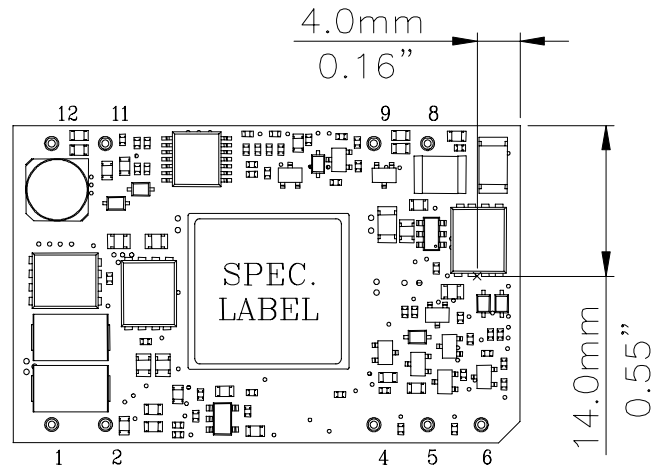
### Thermal Derating

Heat can be removed by increasing airflow over the module. Figure 19 shows maximum output is a function of ambient temperature and airflow rate. To enhance system reliability, the power module should always be operated below the maximum operating temperature. If the temperature exceeds the maximum module temperature, reliability of the unit may be affected.

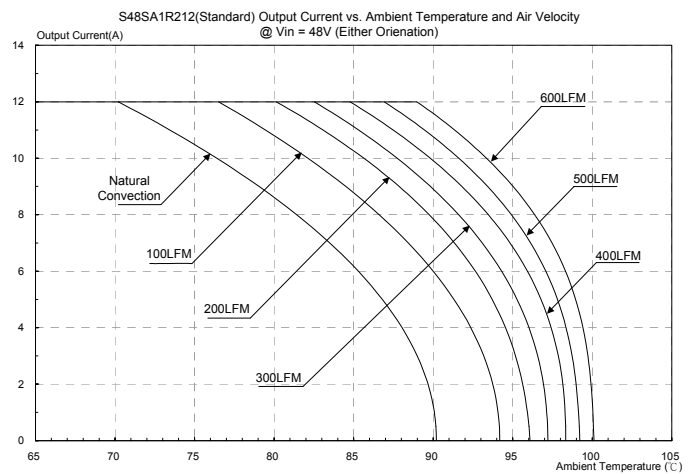


Note: Wind Tunnel Test Setup Figure Dimensions are in millimeters and (Inches)  
**Figure 17: Wind tunnel test setup**

## THERMAL CURVES



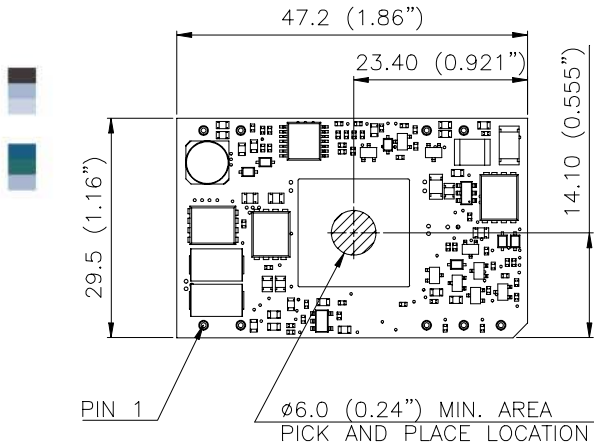
**Figure 18: Hot spot temperature measured point**  
 \*The allowed maximum hot spot temperature is defined at 102 °C



**Figure 19: Output current vs. ambient temperature and air velocity**  
 @  $V_{in}=48V$

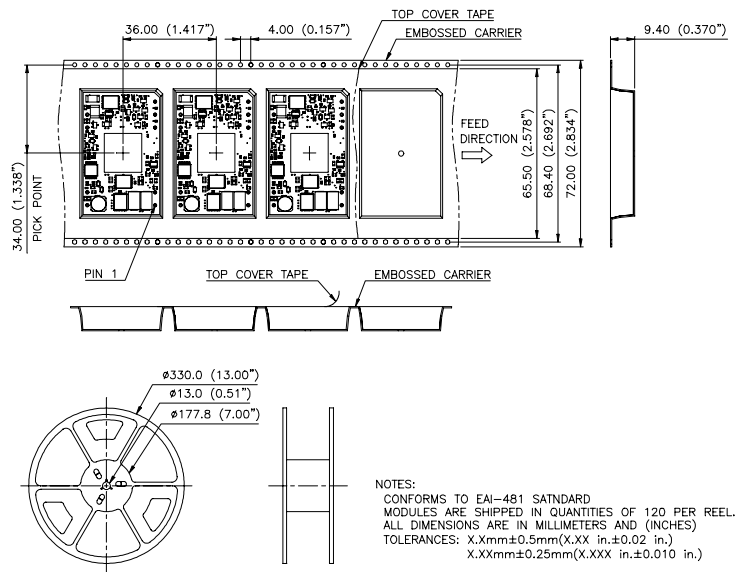


## PICK AND PLACE LOCATION



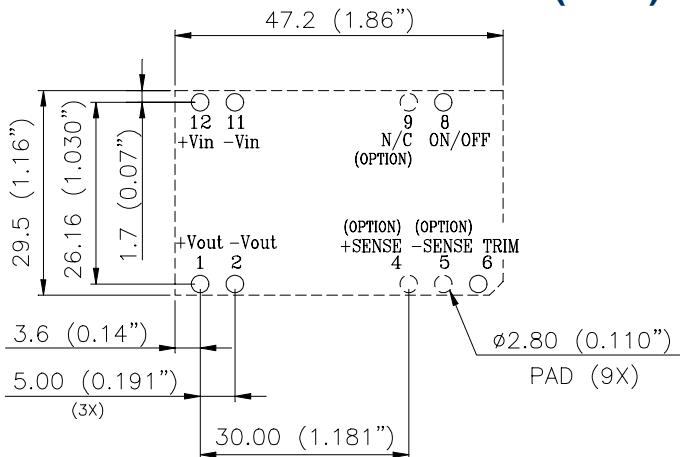
NOTES:  
 ALL DIMENSIONS ARE IN MILLIMETERS AND (INCHES)  
 TOLERANCES: X.Xmm±0.5mm(X.XX in.±0.02 in.)  
 X.XXmm±0.25mm(X.XXX in.±0.010 in.)

## SURFACE-MOUNT TAPE & REEL



NOTES:  
 CONFORMS TO EIA-481 STANDARD  
 MODULES ARE SHIPPED IN QUANTITIES OF 120 PER REEL.  
 ALL DIMENSIONS ARE IN MILLIMETERS AND (INCHES)  
 TOLERANCES: X.Xmm±0.5mm(X.XX in.±0.02 in.)  
 X.XXmm±0.25mm(X.XXX in.±0.010 in.)

## RECOMMENDED PAD LAYOUT (SMD)

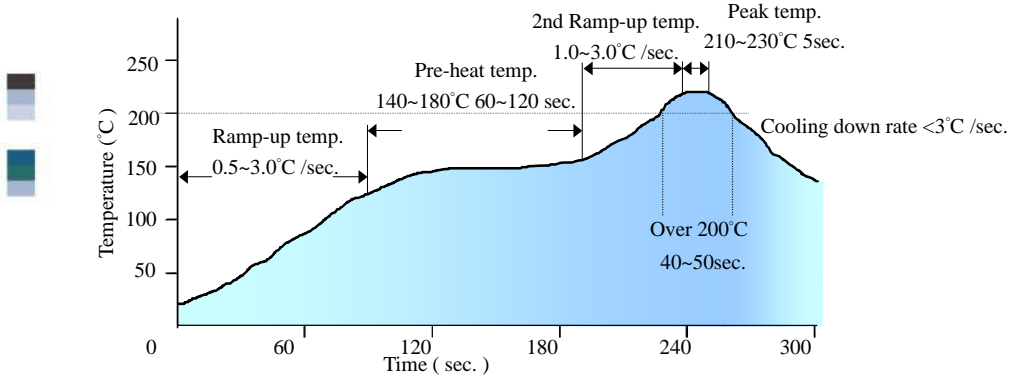


## RECOMENDED P.W.B PAD LAYOUT

NOTES:  
 DIMENSIONS ARE IN MILLIMETERS AND (INCHES)  
 TOLERANCES: X.Xmm±0.5mm(X.XX in.±0.02 in.)  
 X.XXmm±0.25mm(X.XXX in.±0.010 in.)

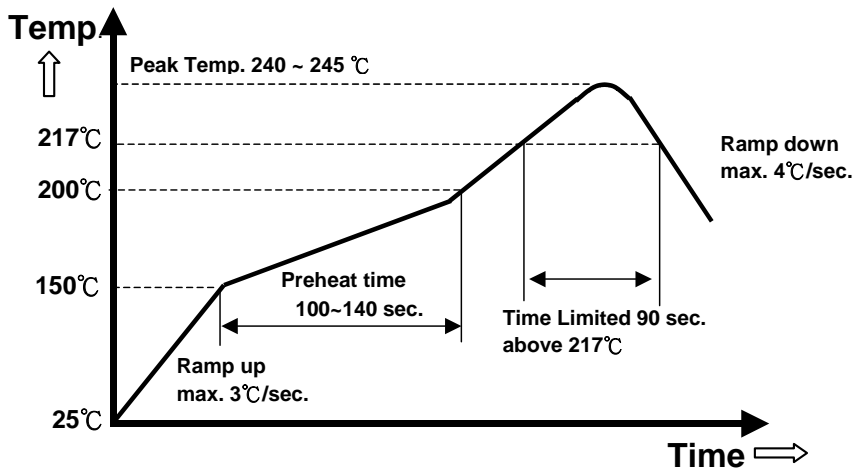


## LEADED (Sn/Pb) PROCESS RECOMMEND TEMP. PROFILE



**Note:** The temperature refers to the pin of S48SA, measured on the pin +Vout joint.

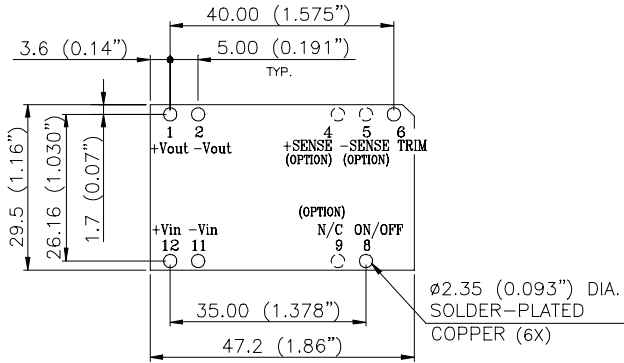
## LEAD FREE (SAC) PROCESS RECOMMEND TEMP. PROFILE



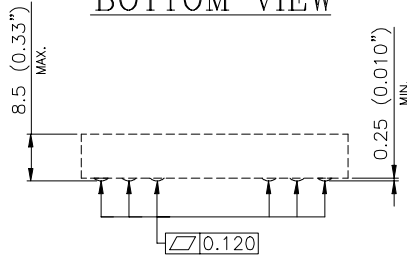
**Note:** The temperature refers to the pin of S48SA, measured on the pin +Vout joint.

# MECHANICAL DRAWING

## Surface-Mount Module

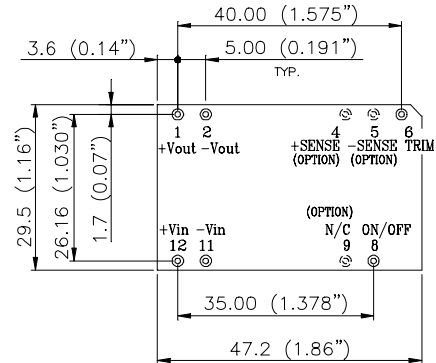


### BOTTOM VIEW

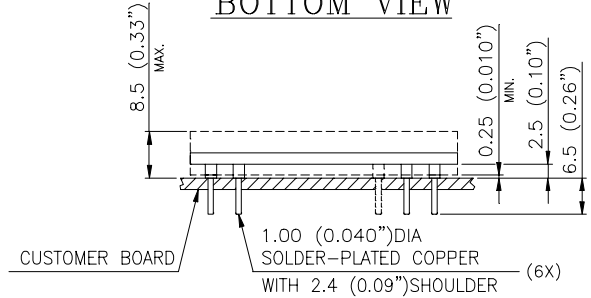


### SIDE VIEW

## Through-Hole Module



### BOTTOM VIEW



### SIDE VIEW

#### NOTES:

DIMENSIONS ARE IN MILLIMETERS AND (INCHES)

TOLERANCES: X.Xmm±0.5mm(X.XX in.±0.02 in.)

X.XXmm±0.25mm(X.XXX in.±0.010 in.)

Pin No.	Name	Function
1	+Vout	Positive output voltage
2	-Vout	Negative output voltage
6	Trim	Output voltage trim
8	ON/OFF	ON/OFF logic
11	-Vin	Negative input voltage
12	+Vin	Positive input voltage

Optional Pin	Name	Function
4	+Sense (Option)	Positive sense pin
5	-Sense (Option)	Negative sense pin
9	NC	No connection

## PART NUMBERING SYSTEM

S	48	S	A	1R2	12	N	R	F	A*
Form Factor	Input Voltage	Number of Outputs	Product Series	Output Voltage	Output Current	ON/OFF Logic	Pin Type		Option Code
S- Small Power	48- 48V	S- Single	A- Advanced	1R2-1.2V 1R5-1.5V 1R8-1.8V 2R5-2.5V 3R3- 3.3V 050- 5.0V 120- 12V	03- 3.0V 06- 6.6A 10- 10A 12- 12A	N- Negative P- Positive	R- SMD T-Through hole	F- RoHS 6/6 (Lead Free)	A- 9 pins, no sense B- 6 pins, no sense C- 9 pins with sense (12V has option B only)

\* Option code A includes 9 pins. Pins 4, 5, and 9 have no connection.

Option code B excludes pin 4, 5, and 9 (total 6 pins).

Option code C features 9 pins with sense function.

## MODEL LIST

MODEL NAME	INPUT		OUTPUT		EFF @ 100% LOAD
S48SA1R212NRFA	36V~75V	0.85A	1.2V	12A	84.0%
S48SA1R512NRFA	36V~75V	0.85A	1.5V	12A	88.0%
S48SA1R812NRFA	36V~75V	0.85A	1.8V	12A	88.0%
S48SA2R510NRFA	36V~75V	1.3A	2.5V	10A	88.5%
S48SA3R310NRFA	36V~75V	1.3A	3.3V	10A	90.5%
S48SA05006NRFA	36V~75V	1.3A	5.0V	6.6A	90.5%
S48SA12003NRFB	36V~75V	1.3A	12V	3.0A	90.0%

**CONTACT:** [www.delta.com.tw/dcdc](http://www.delta.com.tw/dcdc)

### USA:

Telephone:  
East Coast: (888) 335 8201  
West Coast: (888) 335 8208  
Fax: (978) 656 3964  
Email: [DCDC@delta-corp.com](mailto:DCDC@delta-corp.com)

### Europe:

Phone: +41 31 998 53 11  
Fax: +41 31 998 53 53  
Email: [DCDC@delta-es.com](mailto:DCDC@delta-es.com)

### Asia & the rest of world:

Telephone: +886 3 4526107 ext 6220  
Fax: +886 3 4513485  
Email: [DCDC@delta.com.tw](mailto:DCDC@delta.com.tw)

## WARRANTY

Delta offers a two (2) year limited warranty. Complete warranty information is listed on our web site or is available upon request from Delta.

Information furnished by Delta is believed to be accurate and reliable. However, no responsibility is assumed by Delta for its use, nor for any infringements of patents or other rights of third parties, which may result from its use. No license is granted by implication or otherwise under any patent or patent rights of Delta. Delta reserves the right to revise these specifications at any time, without notice.