

CKT. SIZE	DIMENSION A		DIMENSION B		DIMENSION C	
	MM	IN.	MM	IN.	MM	IN.
3	8.13	.320	5.08	.200	0.15	.006
4	10.67	.420	7.62	.300	0.15	.006
5	13.21	.520	10.16	.400	0.15	.006
6	15.75	.620	12.70	.500	0.15	.006
7	18.29	.720	15.24	.600	0.15	.006
8	20.83	.820	17.78	.700	0.15	.006
9	23.37	.920	20.32	.800	0.15	.006
10	25.91	1.020	22.86	.900	0.15	.006
11	28.45	1.120	25.40	1.000	0.15	.006
12	30.99	1.220	27.94	1.100	0.15	.006
13	33.53	1.320	30.48	1.200	0.15	.006
14	36.07	1.420	33.02	1.300	0.15	.006
15	38.61	1.520	35.56	1.400	0.15	.006
16	41.15	1.620	38.10	1.500	0.15	.006
17	43.69	1.720	40.64	1.600	0.15	.006
18	46.23	1.820	43.18	1.700	0.15	.006
19	48.77	1.920	45.72	1.800	0.15	.006
20	51.31	2.020	48.26	1.900	0.18	.007
21	53.85	2.120	50.80	2.000	0.18	.007
22	56.39	2.220	53.34	2.100	0.18	.007
23	58.93	2.320	55.88	2.200	0.18	.007
24	61.47	2.420	58.42	2.300	0.18	.007

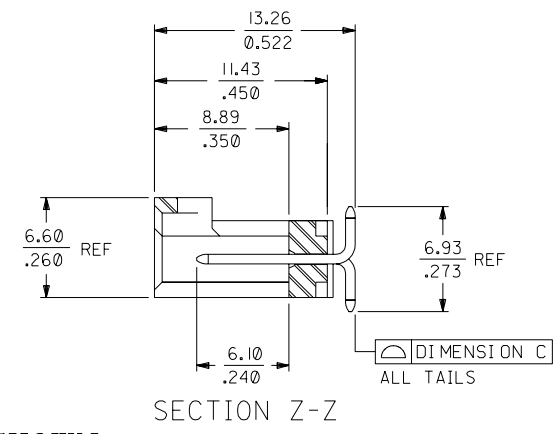
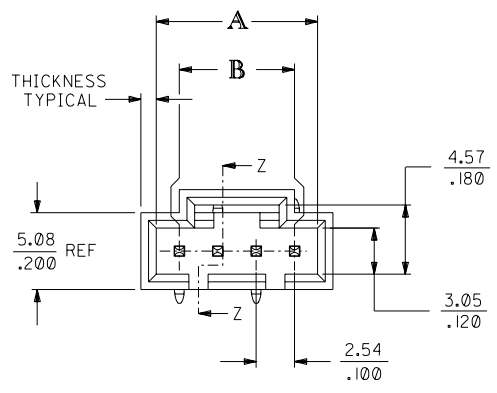
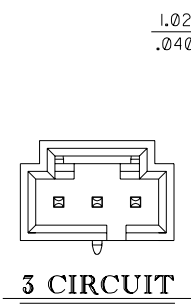
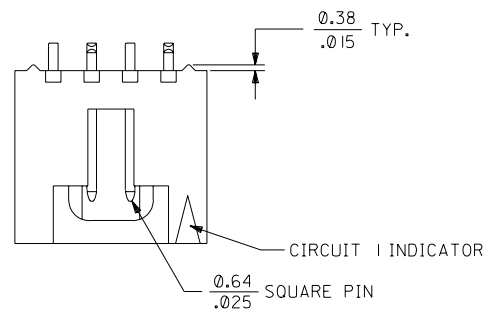

4 CIRCUIT SHOWN

NOTES:

- HEADER MATERIAL: GLASS FILLED POLYESTER; UL94V-0; COLOR: BLACK
PIN MATERIAL: PHOSPHOR BRONZE
- HEADER TO BE USED WITH OPTION *G* 70400 AND 70430 SERIES SL CONNECTORS.
- REFER TO MOLEX PRODUCT SPECIFICATION PS-70541.
- PRODUCT PACKAGED PER PK-70873-003.
- PLATINGS (SEE CHART ON SHEET 2):
 TIN-LEAD - .000150 MINIMUM TIN-LEAD PLATE OVER NICKEL PLATE.
 15 GOLD - .000015 MINIMUM GOLD PLATE IN SELECT AREA, .000075 MINIMUM TIN-LEAD PLATE IN SELECT AREA, OVER NICKEL PLATE OVERALL.
 30 GOLD - .000030 MINIMUM GOLD PLATE IN SELECT AREA, .000075 MINIMUM TIN-LEAD PLATE IN SELECT AREA, OVER NICKEL PLATE OVERALL.

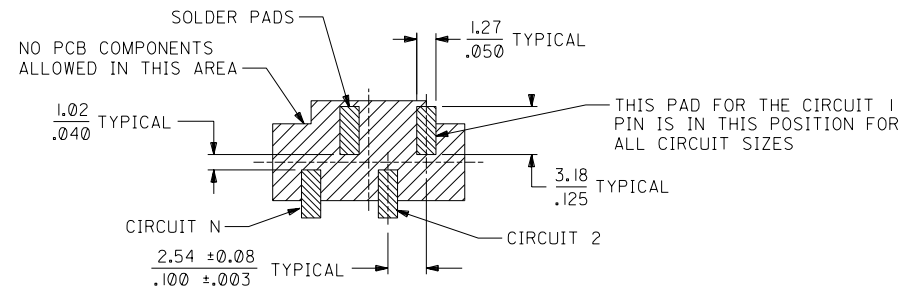



RECOMMENDED PC BOARD LAYOUT

ADD PART NUMBERS EC NO. UCP2003-0118 DRAWN: DMORGAN 02/07/02 CHK: BBARKER 02/07/02 APPR: SMILLER 02/07/02	DESCRIPTION MAJOR CRITICAL	QUALITY SYMBOLS = 0 / C = 0	GENERAL TOLERANCES: (UNLESS SPECIFIED) mm INCH 4 PLACES ±0. ±. 3 PLACES ±0. ±.010 2 PLACES ±0.25 ±. 1 PLACE ±0. ±. ANGULAR: ±1/2 °	SCALE 4:1 DESIGN UNITS <input type="checkbox"/> mm <input checked="" type="checkbox"/> INCH	THIRD ANGLE PROJECTION TITLE: SALES ASSY, SL VERTICAL HEADER, SMT W/ LATCH NO PEGS, (2.54)/.100 CENTERS MOLEX INCORPORATED	DIMENSIONS: <input checked="" type="checkbox"/> mm <input type="checkbox"/> INCH <input type="checkbox"/> mm ONLY	SHEET NO. 1 OF 2 REV B	
		DRAWN BY & DATE BBARKER 02/01/03	CHECKED BY & DATE DMORGAN 02/01/03	APPROVED BY & DATE SMILLER 02/01/03	CAD FILENAME	MATERIAL NO. SEE CHART	DRAWING NO. SD-74099-001	SIZE C
		DRAFT WHERE APPLICABLE MUST REMAIN WITHIN DIMENSIONS			THIS DRAWING CONTAINS INFORMATION THAT IS PROPRIETARY TO MOLEX INCORPORATED AND SHOULD NOT BE USED WITHOUT WRITTEN PERMISSION.			
		REV B						

	13	12	11	10	9	8	7	6	5	4	3	2	74099
J	CIRCUIT SIZE	ASSEMBLY ITEM NUMBER 74099	PLATING SEE NOTE 6	MATING END PLATING TYPE	P.C. BOARD END PLATING TYPE								
	3-24	-0003-0024	TIN-LEAD	TIN/LEAD	TIN/LEAD								
I	3-24	-1003-1024	15 GOLD	GOLD	TIN/LEAD								
	3-24	-2003-2024	30 GOLD	GOLD	TIN/LEAD								
H													

G	CIRCUIT SIZE	ASSEMBLY ITEM NUMBER	ASSEMBLY ITEM NUMBER	ASSEMBLY ITEM NUMBER	ASSEMBLY ITEM NUMBER	ASSEMBLY ITEM NUMBER	ASSEMBLY ITEM NUMBER						
	3	74099-0003	74099-1003	74099-2003									
	4	74099-0004	74099-1004	74099-2004									
	5	74099-0005	74099-1005	74099-2005									
	6	74099-0006	74099-1006	74099-2006									
F	7	74099-0007	74099-1007	74099-2007									
	8	74099-0008	74099-1008	74099-2008									
	9	74099-0009	74099-1009	74099-2009									
	10	74099-0010	74099-1010	74099-2010									
	11	74099-0011	74099-1011	74099-2011									
	12	74099-0012	74099-1012	74099-2012									
	13	74099-0013	74099-1013	74099-2013									
E	14	74099-0014	74099-1014	74099-2014									
	15	74099-0015	74099-1015	74099-2015									
	16	74099-0016	74099-1016	74099-2016									
	17	74099-0017	74099-1017	74099-2017									
	18	74099-0018	74099-1018	74099-2018									
	19	74099-0019	74099-1019	74099-2019									
D	20	74099-0020	74099-1020	74099-2020									
	21	74099-0021	74099-1021	74099-2021									
	22	74099-0022	74099-1022	74099-2022									
	23	74099-0023	74099-1023	74099-2023									
	24	74099-0024	74099-1024	74099-2024									

C													
B													
A													

ADD PART NUMBERS EC No. UCP2003-0118 DRW: DMORGAN 02/07/22 CHK: BBARKER 02/07/22 APPR: SMILLER 02/07/22	QUALITY SYMBOLS MAJOR  =0 CRITICAL  =0	GENERAL TOLERANCES: (UNLESS SPECIFIED)	SCALE : <input type="checkbox"/> mm <input type="checkbox"/> INCH	DESIGN UNITS <input type="checkbox"/> mm <input type="checkbox"/> INCH	THIRD ANGLE PROJECTION <input checked="" type="checkbox"/> mm <input type="checkbox"/> INCH <input type="checkbox"/> mm ONLY	DIMENSIONS: <input checked="" type="checkbox"/> mm <input type="checkbox"/> INCH <input type="checkbox"/> mm ONLY	SHT REV	REVISE ON CAD ONLY	
	DRAWN BY & DATE BBARKER 01/11/29		CHECKED BY & DATE DMORGAN 01/11/29		APPROVED BY & DATE SMILLER 01/11/29		TITLE: SALES ASSY, SL VERTICAL HEADER, SMT W/ LATCH NO PEGS, (2.54)/.100 CENTERS		
	ANGLAR: ± 1/2 °		CAD FILENAME		MATERIAL NO. SEE CHART		DRAWING NO. SD-74099-001		SHEET NO. 2
	DRAFT WHERE APPLICABLE MUST REMAIN WITHIN DIMENSIONS		THIS DRAWING CONTAINS INFORMATION THAT IS PROPRIETARY TO MOLEX INCORPORATED AND SHOULD NOT BE USED WITHOUT WRITTEN PERMISSION.						