

PHAP33 series

Tact switches

Distinctive features and specifications

- Wide range of case formats
- SMT and through-hole models
- Normally closed models available

Models	PHAP3381 PHAP3382 PHAP3383 PHAP3384 PHAP3390 PHAP3391	PHAP3371 PHAP3372 PHAP3373 PHAP3374 PHAP3378	PHAP3355 PHAP3361 PHAP3362 PHAP3363 PHAP3365 PHAP3366	PHAP3301 PHAP3302 PHAP3303 PHAP3305 PHAP3306 PHAP3307 PHAP3308 PHAP3368	PHAP3350 PHAP3351 PHAP3352 PHAP3353	PHAP3320 PHAP3321
Current/voltage rating	50mA 12VDC					
Contact resistance	100 mΩ max.					
Insulation resistance	100 MΩ min.					
Dielectric strength	250 VAC min. (1 minute)					
Electrical life (cycles)	70.000	75.000	30.000	100.000	100.000	100.000
Operating force	1,6N ± 0,5N	1,6N +0,5/-0,3N	1,8N ± 0,5N	1,6N ± 0,5N	2N ± 0,3N	1,6N ± 0,5N
Travel	0,20/ 0,25 mm	0,25 mm	0,25 mm	0,25 mm	0,50 mm	0,30 mm
Operating temperature	-20°C to +70°C					
Storage temperature	-30°C to +80°C					
Vibrations	10-500 Hz / 10 g					
IR reflow soldering	240°C for 20 seconds max.			-		
Wave soldering	255°C for 5 seconds max.					
Manual soldering	300°C for 3 seconds max.					

Dimensions : First dimensions are in mm while inches are shown as bracketted numbers.



Packaging unit : 1.000 pieces and multiples, except for tape and reel packaging (see following pages).

PHAP33 series

SMT tact switches

Microminiature and ultra-low profile - 4,2 x 4,2 mm case

- Ultra-compact size for board space saving : 4,2 x 4,2 mm case, 1,5 mm button height from PCB
- Reflow solderable
- With or without positioning pins
- For tape and reel packaging, add "R" at the end of model number.

With positioning pins



Model number
PHAP3390

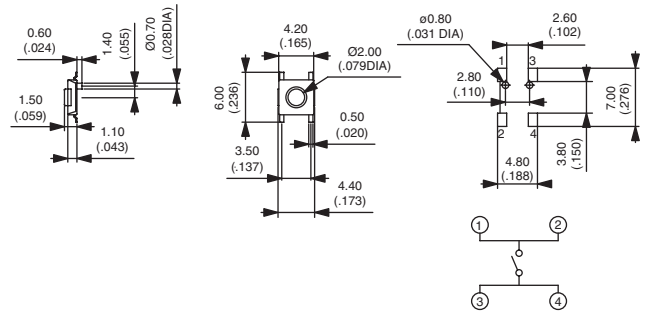

Operating force : 2,6N \pm 0,5N - Travel : 0,20 mm

Without positioning pins



Model number
PHAP3391

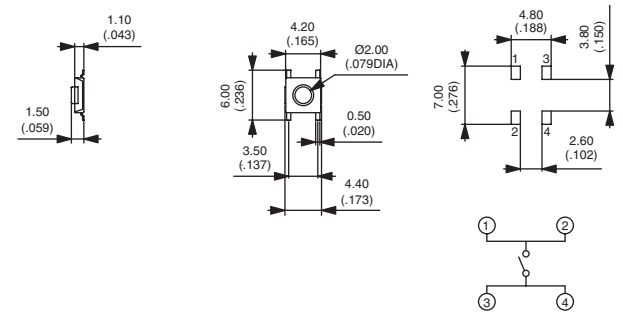

Operating force : 2,6N \pm 0,5N - Travel : 0,20 mm

PACKAGING

To order a product with tape and reel packaging, add "R" at the end of its model number.

Example : PHAP3390R.

Quantity per reel : 3.400 pieces

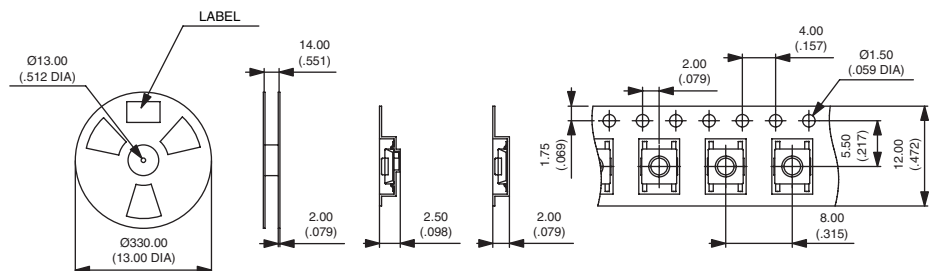

PHAP33 series

SMT tact switches

Ultra-low profile - 6 x 6 mm case

- Ultra-compact size for board space saving : 6 x 6 mm case, 1,6 mm button height from PCB
- Reflow solderable
- Types for iron soldering (L = 10 mm)
- With positioning pins
- With or without grounding tab for protection against electrostatic discharges
- For tape and reel packaging, add "R" at the end of model number.

Without grounding tab



Model No	Dim. «L»
PHAP3381	8 mm
PHAP3382	10 mm

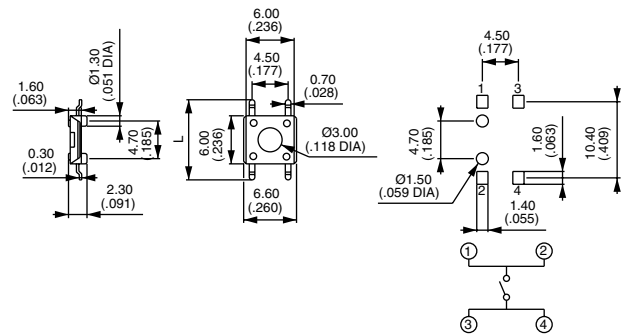

Operating force : 1,6N ± 0,5N - Travel : 0,25 mm

With grounding tab



Model No	Dim. «L»
PHAP3383	8 mm
PHAP3384	10 mm

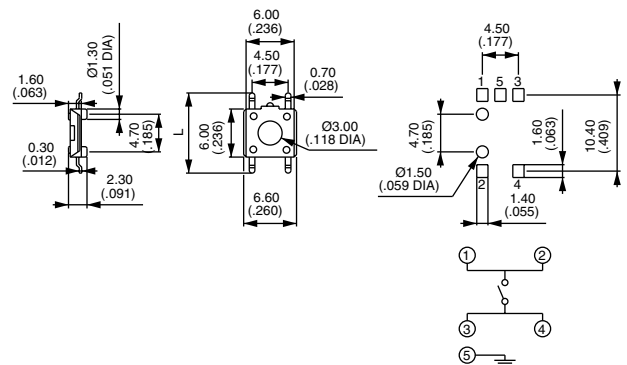

Operating force : 1,6N ± 0,5N - Travel : 0,25 mm

PACKAGING

To order a product with tape and reel packaging, add "R" at the end of its model number.

Example : PHAP3383R.

Quantity per reel : 2.200 pieces

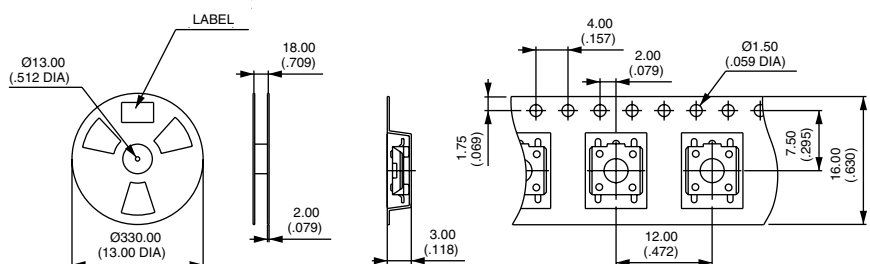

PHAP33 series

SMT tact switches

Low profile - 6,2 x 6,2 mm case

- Ultra-compact size for board space saving : 6,2 x 6,2 mm case, 2,6 to 3,4 mm button height from PCB
- Reflow solderable
- With or without grounding tab for protection against electrostatic discharges
- Models with external terminals type G or internal terminals type J
- For tape and reel packaging, add "R" at the end of model number.

External terminals type G (gullwing)



Model No	Dim. «L»
PHAP3371	2,6 mm
PHAP3371A	3,4 mm

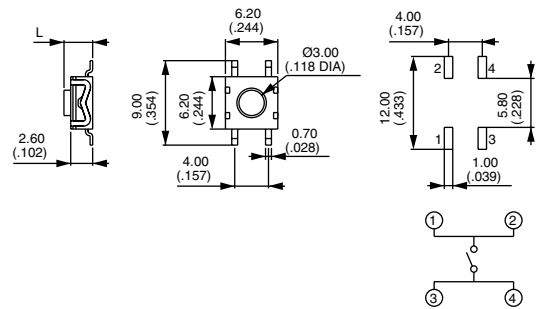

Operating force : 1,6N + 0,5N/-0,3N - Travel : 0,25 mm

Internal terminals type J - tape and reel packaging



Model No	Dim. «L»
PHAP3372R	2,6 mm
PHAP3372AR	3,4 mm

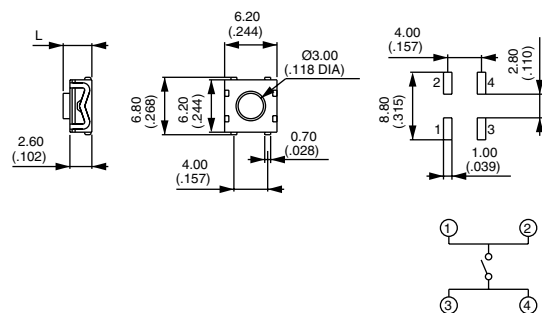

Operating force : 1,6N + 0,5N/-0,3N - Travel : 0,25 mm

PACKAGING

To order a product with tape and reel packaging, add "R" at the end of its model number.

Example : PHAP3371R.

Quantity per reel : 1.600 pieces

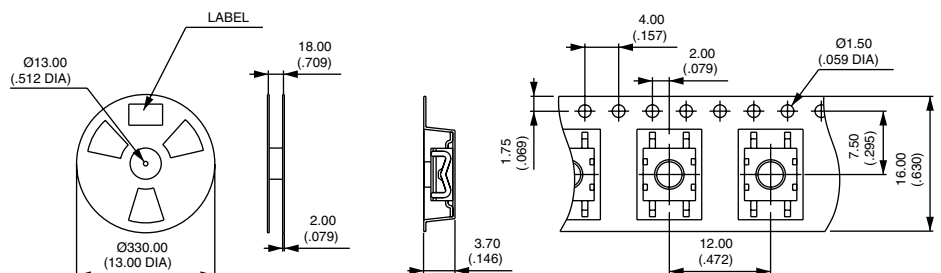

PHAP33 series

SMT tact switches

Low profile - 6,2 x 6,2 mm case

Button height from PCB : 2,9 mm



Model No
PHAP3373

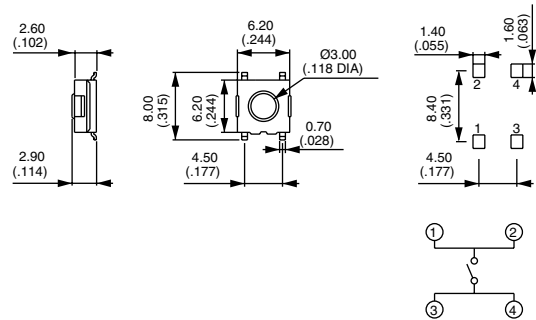

Operating force : 1,6N + 0,5N/-0,3N - Travel : 0,25 mm

Button height from PCB : 3,1 mm - with grounding tab



Model No	Dim. «L»
PHAP3374	8 mm

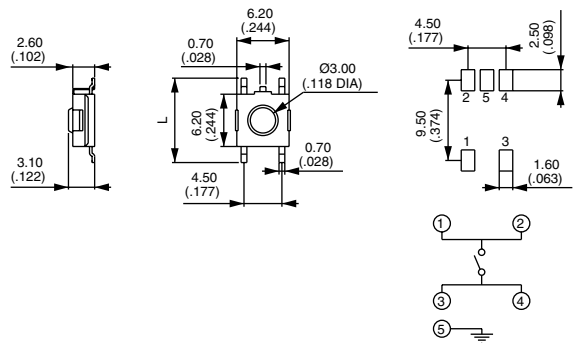

Operating force : 1,6N + 0,5N/-0,3N - Travel : 0,25 mm

PACKAGING

To order a product with tape and reel packaging, add "R" at the end of its model number.
Example : PHAP3373R.
Quantity per reel : 1.700 pieces

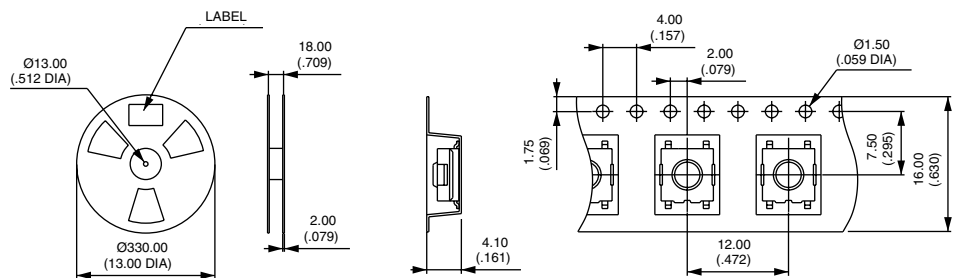

PHAP33 series

SMT tact switches

Normally closed - 7,6 x 7,6 mm case

- Compact size for board space saving : 7,6 x 7,6 mm case, 4,3 mm button height from PCB
- Reflow solderable
- Standard PCB layout

Normally closed



Model No
PHAP3378R

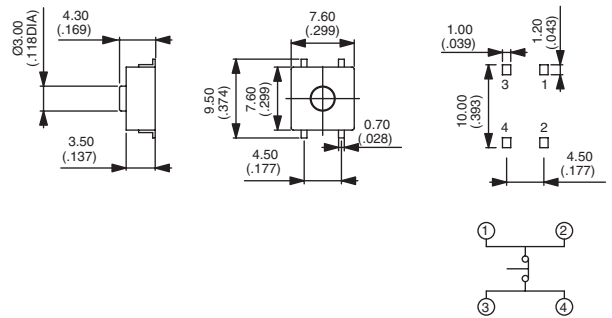

Operating force : 1,6N ± 0,5N - Travel : 0,25 mm

PACKAGING

Quantity per reel : 1.000 pieces

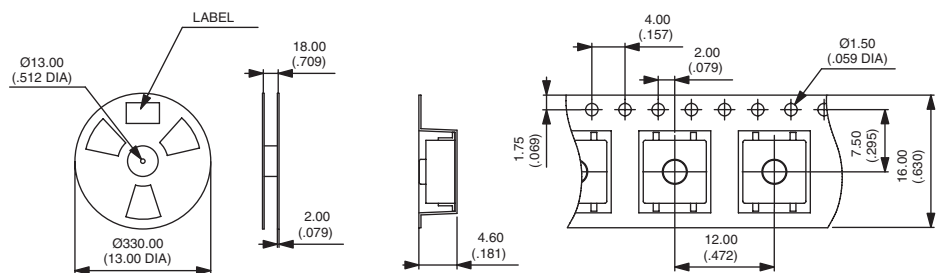

PHAP33 series

SMT tact switches

Microminiature - 6 x 3,5 mm case

- Ultra-compact size for board space saving : 6 x 3,5 mm case, 4,3 or 5 mm button height from PCB
- Right angle version available

Vertical mounting



Model No	Dim. «L»
PHAP3361	4,3 mm
PHAP3361A	5,0 mm

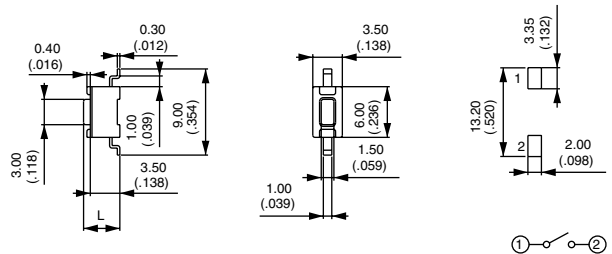

For tape and reel packaging, add "R" at the end of model number.
Operating force : 1,8N ± 0,5N - Travel : 0,25 mm

Horizontal mounting



Model No
PHAP3355R

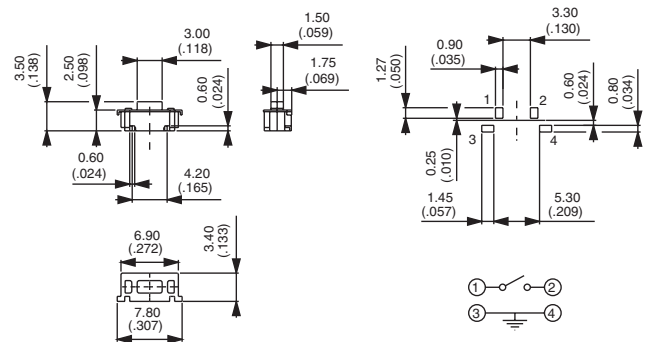

Operating force : 1,8N ± 0,5N - Travel : 0,25 mm

PACKAGING

Quantity per reel :
PHAP3361R : 1.800 pieces
PHAP3361AR : 1.800 pieces
PHAP3355R : 2.000 pieces

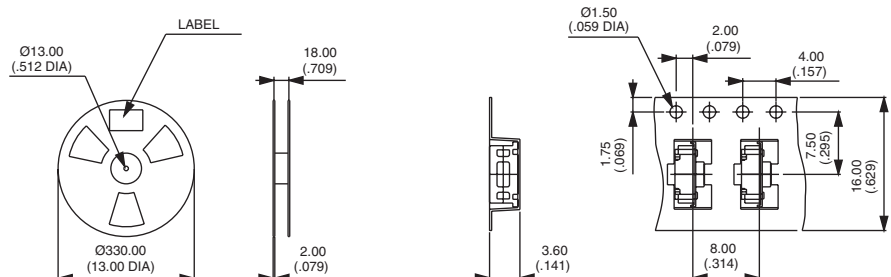

PHAP33 series

SMT tact switches

Microminiature - Low profile - 6,1 x 3,7 mm case

- Ultra-compact size for board space saving : 6,1 x 3,7 mm case, 2,5 mm button height from PCB
- Available with flat or bent terminals

Flat terminals



Model No
PHAP3365R

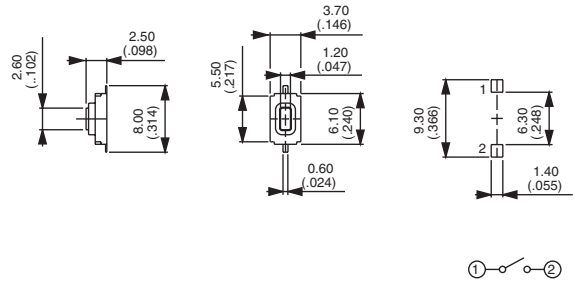

Operating force : 1,8N ± 0,5N - Travel : 0,25 mm

Bent terminals



Model No
PHAP3366R

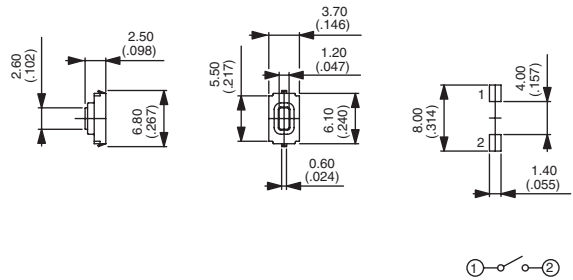

Operating force : 1,8N ± 0,5N - Travel : 0,25 mm

PACKAGING

Quantity per reel : 3.000 pieces

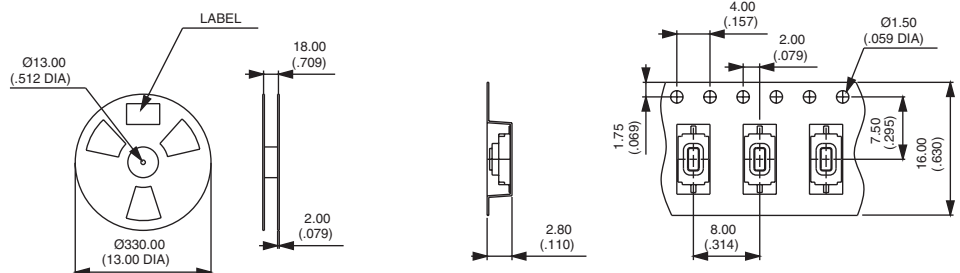

PHAP33 series

SMT tact switches

6 x 6 mm case

- 4,3 to 13 mm button height from PCB
- Excellent tactile feedback (snap dome)
- Standard PCB layout
- Caps for model with square actuator

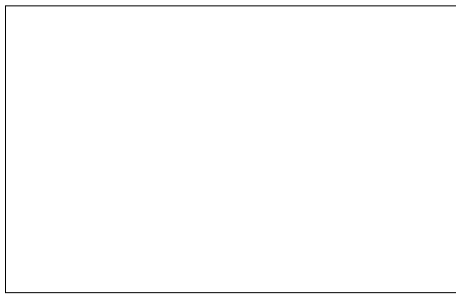

Cap colours : 1 : blue - 2 : black - 3 : green
5 : yellow - 6 : red - 7 : ivory

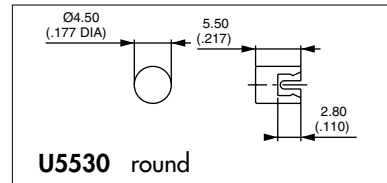
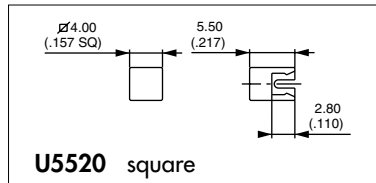

Round actuator



Model No	Dim. «L»	Actuator colour
PHAP3368	4,3 mm	black/white
PHAP3368A	5,0 mm	black/white
PHAP3368B	9,5 mm	black
PHAP3368C	8,0 mm	white
PHAP3368D	13,0 mm	black
PHAP3368E	7,3 mm	ivory
PHAP3368F	8,5 mm	grey

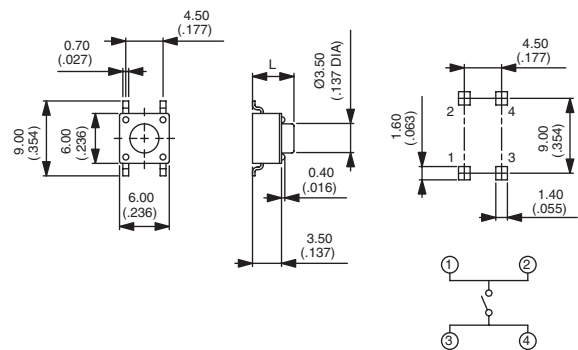

Operating force : 1,6N ± 0,5N - Travel : 0,25 mm

Square actuator



Model No
PHAP3368T

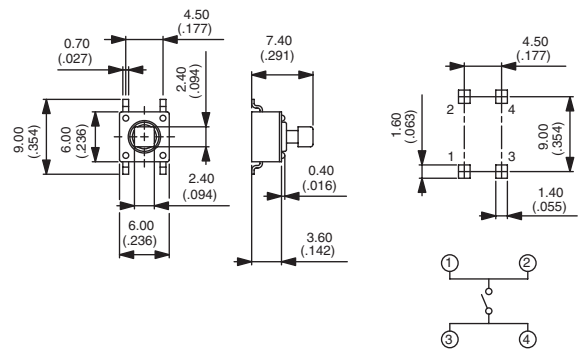

Operating force : 1,6N ± 0,5N - Travel : 0,25 mm

Edge of PCB mounting



Model No
PHAP3305ASR

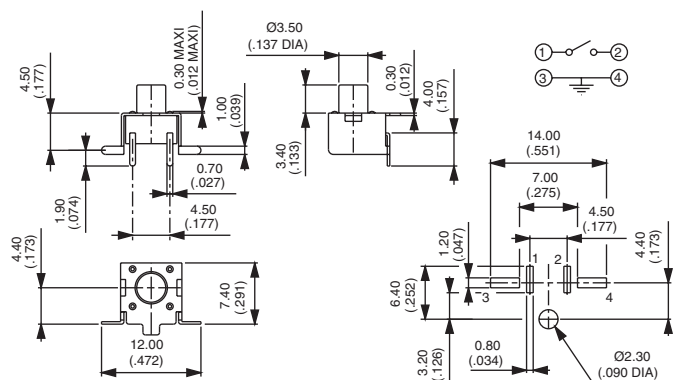

Operating force : 1,6N ± 0,5N - Travel : 0,25 mm
Quantity per reel : 650 pieces

PHAP33 series

Through-hole tact switches

Microminiature - 6 x 3,5 mm case

- Ultra-compact size for board space saving : 6 x 3,5 mm case, 4,3 or 5 mm button height from PCB
- Crimped terminals for direct mounting onto PCB
- Moulded-in terminals for wave soldering

Straight terminals



Model No	Dim. «L»
PHAP3362	4,3 mm
PHAP3362A	5,0 mm

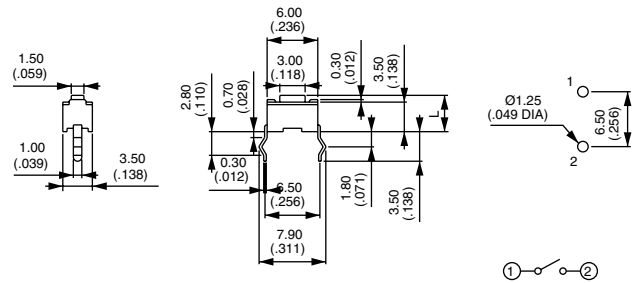

Operating force : 1,8N ± 0,5N - Travel : 0,25 mm

Horizontal mounting



Model No
PHAP3363

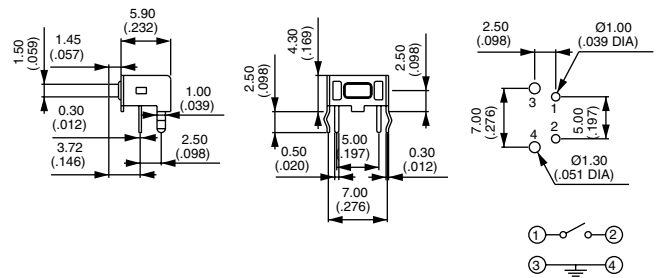

Operating force : 1,8N ± 0,5N - Travel : 0,25 mm

PHAP33 series

Through-hole tact switches

6 x 6 mm case

- 4,3 to 13 mm button height from PCB
- Excellent tactile feedback (snap dome)
- Crimped terminals for direct mounting onto PCB
- With or without grounding tab for protection ag. electrostatic discharges
- Moulded-in terminals for wave soldering
- Caps for model with square actuator (L = 2,4 mm) :

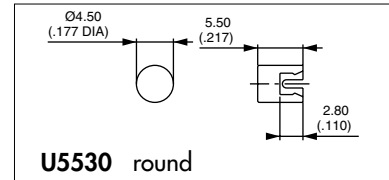
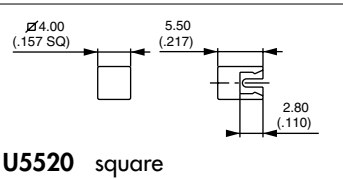

Cap colours : 1 : blue - 2 : black - 3 : green -
5 : yellow - 6 : red - 7 : ivory

Straight terminals



Model No	Dim. «L»	Actuator colour
PHAP3301	4,3 mm	black
PHAP3301A	5,0 mm	black
PHAP3301B	9,5 mm	black
PHAP3301C	8,0 mm	white
PHAP3301D	13,0 mm	black
PHAP3301E	7,3 mm	ivory
PHAP3301F	8,5 mm	grey

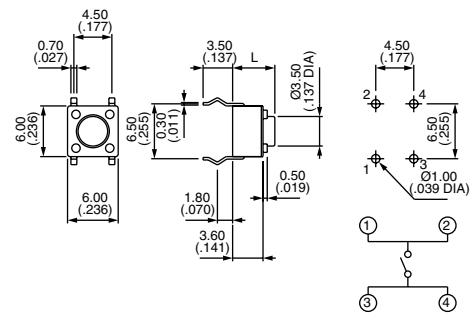

Operating force : 1,6N ± 0,5N - Travel : 0,25 mm

Straight terminals - with grounding tab



Model No	Dim. «L»	Actuator colour
PHAP3302	4,3 mm	black
PHAP3302A	5,0 mm	black
PHAP3302B	9,5 mm	black
PHAP3302C	8,0 mm	white
PHAP3302D	13,0 mm	black
PHAP3302E	7,3 mm	ivory

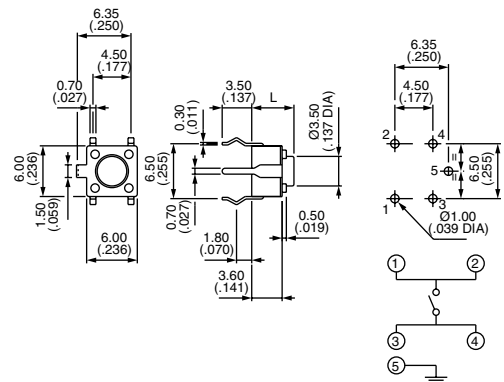

Operating force : 1,6N ± 0,5N - Travel : 0,25 mm

Straight terminals - square actuator



Model No	Dim. «L»	Actuator colour
PHAP3303	2,4mm	blue
PHAP3303A	2,8 mm	black

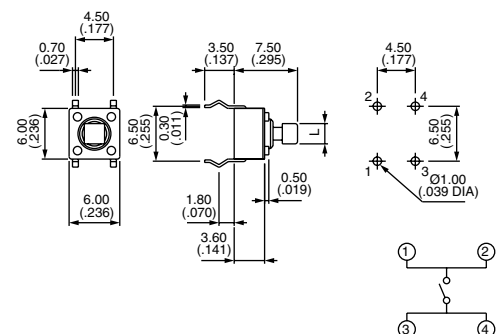

Operating force : 1,6N ± 0,5N - Travel : 0,25 mm

PHAP33 series

Through-hole tact switches

6 x 6 mm case

Horizontal mounting



Model No	Dim. «L»	Actuator colour
PHAP3305	3,15 mm	black
PHAP3305A	3,85 mm	black
PHAP3305B	8,35 mm	black
PHAP3305C	6,85 mm	white
PHAP3305D	11,85 mm	black
PHAP3305E	6,15 mm	ivory
PHAP3305T	6,15 mm	blue 2.4 x 2.4

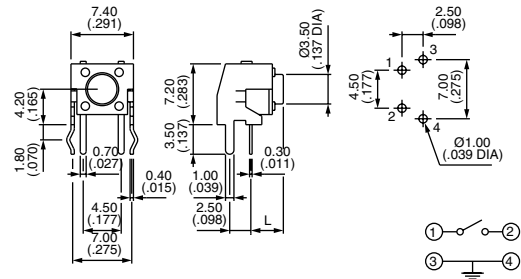

Operating force : $1,6N \pm 0,5N$ - Travel : 0,25 mm

Horizontal mounting of 2 tact switches



Model No	Dim. «L»	Actuator colour
PHAP3306	3,15 mm	black
PHAP3306A	3,85 mm	black
PHAP3306B	8,35 mm	black
PHAP3306C	6,85 mm	white
PHAP3306D	11,85 mm	black
PHAP3306E	6,15 mm	ivory

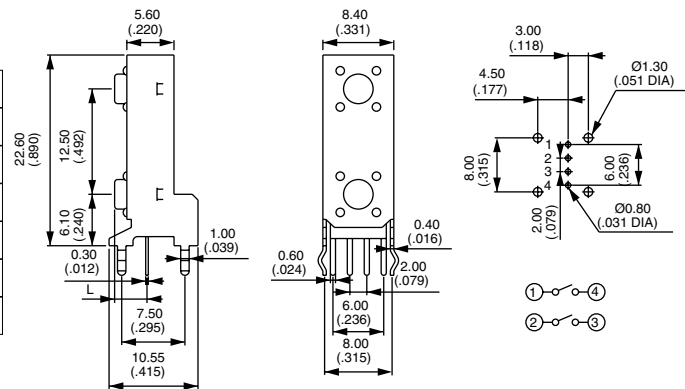

Operating force : $1,6N \pm 0,5N$ - Travel : 0,25 mm

Long straight terminals + tape



Model No	Dim. «L»
PHAP3307	4,3 mm
PHAP3307A	5,0 mm
PHAP3307G	7,0 mm

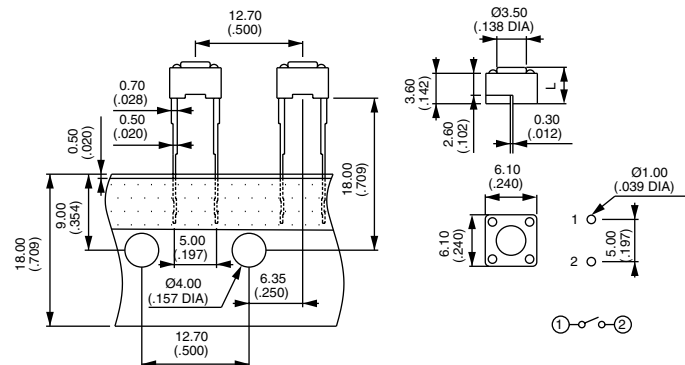

Operating force : $1,6N \pm 0,5N$ - Travel : 0,25 mm
 Quantity per tape : 1.000 pieces

Straight terminals + LED



Model No	LED colour	LED If	LED Vf
PHAP3308	-	-	-
PHAP3308R	red	15mA	2,1V
PHAP3308G	green	30mA	2,2V
PHAP3308Y	yellow	30mA	2V

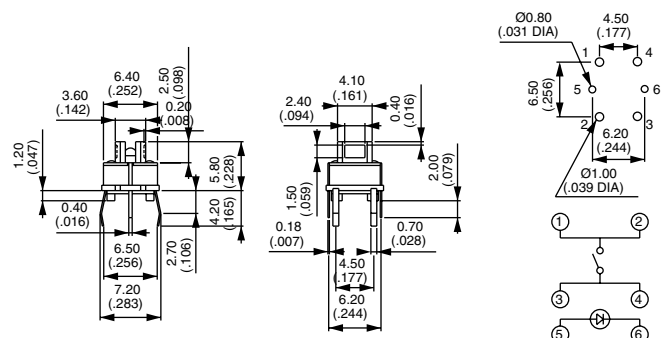

Operating force : $1,6N \pm 0,5N$ - Travel : 0,25 mm

PHAP33 series

Through-hole tact switches

Sealed - 7,2 x 7,2 mm or 10 x 10 mm case

- Dust and splash proof
- Crimped terminals for direct mounting onto PCB
- With or without grounding tab for protection against electrostatic discharges
- Moulded-in terminals for wave soldering

7,2 x 7,2 mm case - straight terminals - grounding or not



Grounding	Dim. «L»
PHAP3350	5,0 mm
PHAP3350A	9,0 mm
PHAP3350B	13,0 mm
Non grounding	Dim. «L»
PHAP3351	5,0 mm
PHAP3351A	9,0 mm
PHAP3351B	13,0 mm

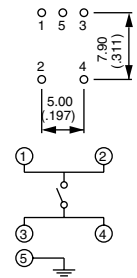
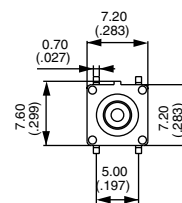
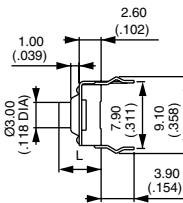

Operating force : 2N ± 0,3N - Travel : 0,50 mm

7,2 x 7,2 mm case - right angle terminals



Model No	Dim. «L»
PHAP3352	4,35 mm
PHAP3352A	8,35 mm
PHAP3352B	12,35 mm

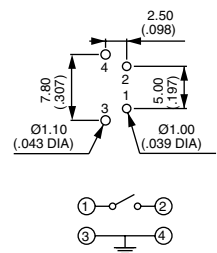
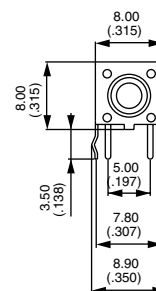
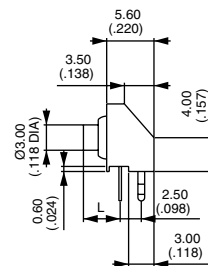

Operating force : 2N ± 0,3N - Travel : 0,50 mm

10 x 10 mm case - straight terminals



Model No
PHAP3353

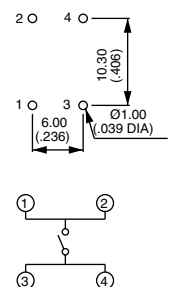
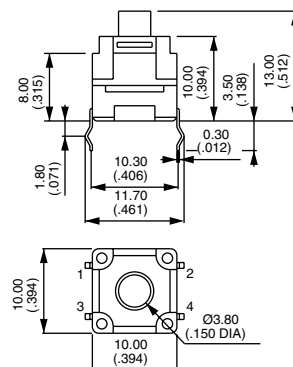
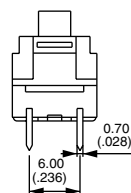

Operating force : 1,6N ± 0,5N - Travel : 0,50 mm

PHAP33 series

Through-hole tact switches

12 x 12 mm case

- 4,3 to 12 mm button height from PCB
- Excellent tactile feedback (snap-dome)
- Crimped terminals for direct mounting onto PCB
- Moulded-in terminals for wave soldering
- Caps for model PHAP3321 :

Cap colours : 1 : blue - 2 : black - 3 : green
5 : yellow - 6 : red - 7 : ivory

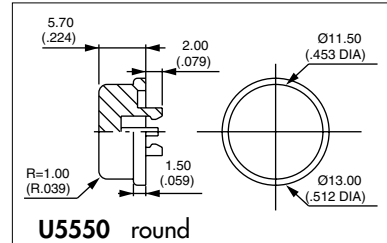
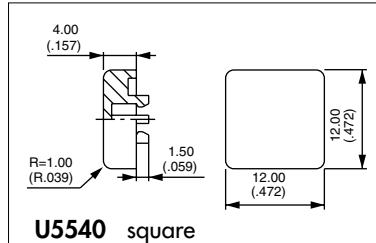

Straight terminals - short actuator



Model No	Dim. «L»
PHAP3320	4,3 mm
PHAP3320A	7,5 mm

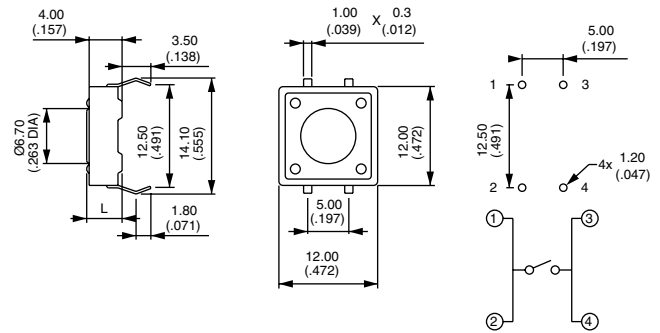

Operating force : 1,6N ± 0,5N - Travel : 0,30 mm

Straight terminals - long keyed actuator



Model No
PHAP3320B

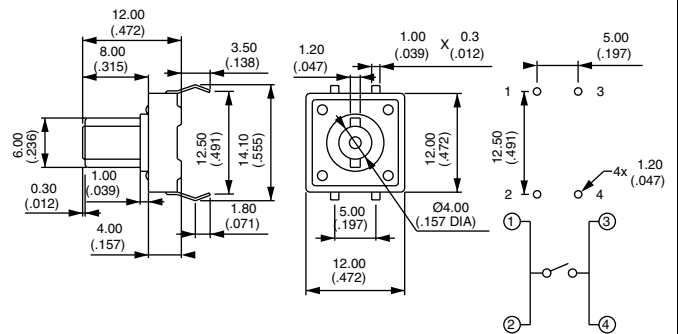

Operating force : 1,6N ± 0,5N - Travel : 0,30 mm

Straight terminals - square actuator



Model No
PHAP3321

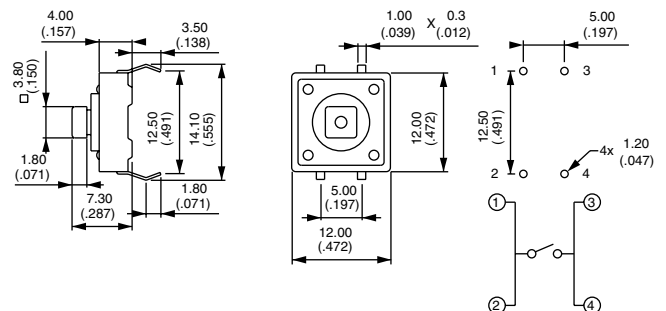

Operating force : 1,6N ± 0,5N - Travel : 0,30 mm