



# CV211-2A

UMTS-band Dual-Branch Downconverter

The Communications Edge™

Product Information

## Product Features

- High dynamic range downconverter with integrated LO and IF amplifiers
- Dual channels for diversity
- +30 dBm Input IP3
- +12.5 dBm Input P1dB
- RF: 1900 – 2200 MHz
- IF: 65 – 300 MHz
- +5V Single supply operation
- Pb-free 6mm 28-pin QFN package
- Low-side LO configuration
- Common footprint with other PCS/cellular versions

## Product Description

The CV211-2A is a dual-channel high-linearity downconverter designed to meet the demanding performance, functionality, and cost goals of current and next generation mobile infrastructure basestations. It provides high dynamic range performance in a low profile surface-mount leadless package that measures 6 x 6 mm square.

It is ideally suited for high dynamic range receiver front ends using diversity receive channels. Functionality includes frequency conversion and IF amplification, while an integrated LO driver amplifier powers the passive mixer. The MCM is implemented with reliable and mature GaAs MESFET and InGaP HBT technology.

Typical applications include frequency downconversion used in W-CDMA 2.5G and 3G mobile base transceiver stations.

## Functional Diagram

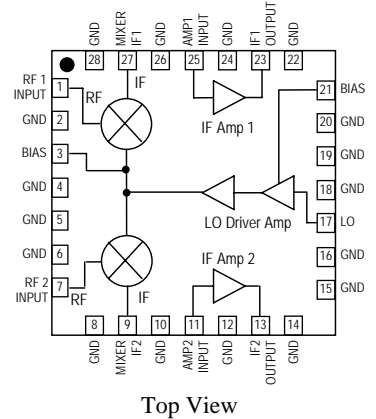

## Specifications <sup>(1)</sup>

Parameters	Units	Min	Typ	Max	Comments
RF Frequency Range	MHz		1900 – 2200		
LO Frequency Range	MHz		1600 – 2135		
IF Frequency Range	MHz		65 – 300		See note 2
% Bandwidth around IF center frequency	%		±7.5		See note 3
IF Test Frequency	MHz		240		
SSB Conversion Gain	dB	8	10	12	Temp = 25 °C
Gain Drift over Temp (-40 to 85 °C)	dB	-1.5	±0.6	+1.5	Referenced to +25 °C
Input IP3	dBm	+25	+30		See note 4
Input IP2	dBm	+33	+37		See note 4
Input 1 dB Compression Point	dBm		+12.5		See note 4
Noise Figure	dB		11		See note 5
LO Input Drive Level	dBm	-2.5	0	+2.5	
LO-RF Isolation	dB		12		P <sub>LO</sub> = 0 dBm
LO-IF Isolation	dB		26		P <sub>LO</sub> = 0 dBm
Branch-Branch Isolation	dB		44		
Return Loss: RF Port	dB		15		
Return Loss: LO Port	dB		18		
Return Loss: IF Port	dB		14		
Operating Supply Voltage	V		+5		
Supply Current	mA	320	380	475	
Thermal Resistance	°C / W			27	
Junction Temperature	°C			160	See note 6

1. Specifications when using the application specific circuit (shown on page 3) with a low side LO = 0 dBm and IF = 240 MHz in a downconverting application at 25 °C.
2. IF matching components affect the center IF frequency. Proper component values for other IF center frequencies than shown can be provided by emailing to applications.engineering@wj.com.
3. The IF bandwidth of the converter is defined as 15% around any center frequency in its operating IF frequency range. The bandwidth is determined with external components. Specifications are valid around the total ±7.5% bandwidth. i.e. with a center frequency of 240 MHz, the specifications are valid from 240 ± 18 MHz.
4. Assumes the supply voltage = +5 V. IIP3 is measured with Δf = 1 MHz with RF<sub>in</sub> = -5 dBm / tone.
5. Assumes LO injection noise is filtered at the thermal noise floor, -174 dBm/Hz, at the RF, IF, and Image frequencies.
6. The maximum junction temperature ensures a minimum MTTF rating of 1 million hours of usage.

## Absolute Maximum Rating

Parameter	Rating
Operating Case Temperature	-40 to +85 °C
Storage Temperature	-55 to +150 °C
DC Voltage	+5.5 V
Junction Temperature	+220 °C

Operation of this device above any of these parameters may cause permanent damage.

## Ordering Information

Part No.	Description
CV211-2AF	UMTS-band Dual-Branch Downconverter (lead-free/RoHS-compliant 6x6mm QFN package)
CV211-2APCB75	Fully Assembled Eval. Board, IF = 75MHz
CV211-2APCB240	Fully Assembled Eval. Board, IF = 240MHz

Specifications and information are subject to change without notice



# CV211-2A

UMTS-band Dual-Branch Downconverter

The Communications Edge™

Product Information

## Device Architecture / Application Circuit Information

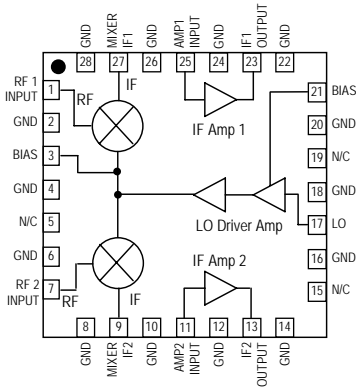

Typical Downconverter Performance Chain Analysis (Each Branch)

Stage	Gain (dB)	Input P1dB (dBm)	Input IP3 (dBm)	NF (dB)	Current (mA)	Cumulative Performance			
						Gain (dB)	Input P1dB (dBm)	Input IP3 (dBm)	NF (dB)
LO Amp / MMIC Mixer	-8.7	20	35	9.0	80	-8.7	20.0	35	9
IF Amplifier	18.7	4.6	23	2.1	150	10.0	12.5	30	11
<b>CV211-2A</b>	<b>Cumulative Performance</b>				<b>380*</b>	<b>10.0</b>	<b>12.5</b>	<b>30</b>	<b>11</b>

\* The 2<sup>nd</sup> branch includes another mixer and IF amplifier, which increases the total current consumption of the MCM to be 380 mA.

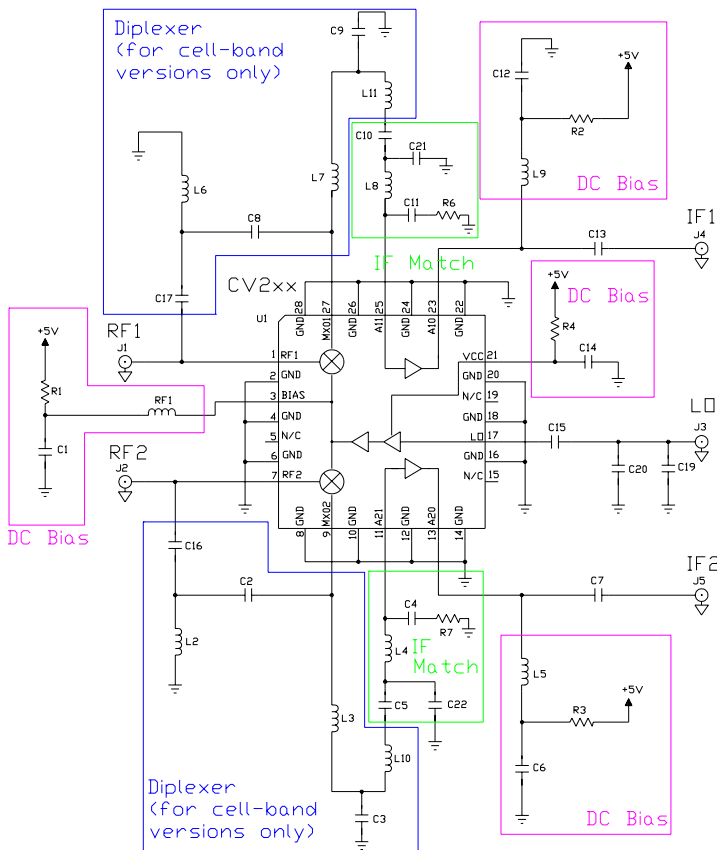

Printed Circuit Board Material:  
.014" FR-4, 4 layers, .062" total thickness

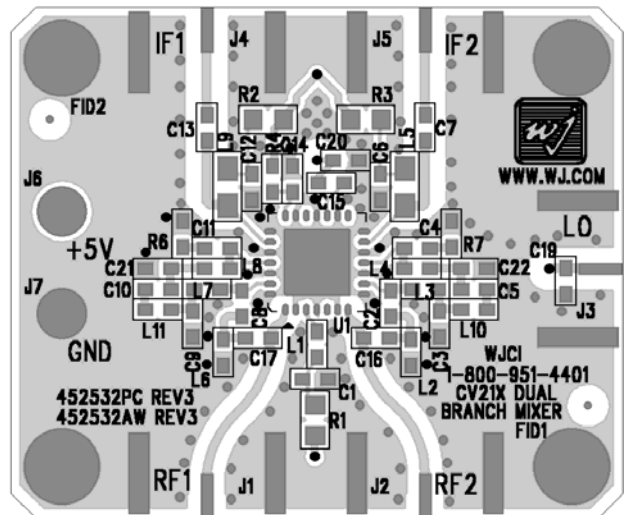

**CV211-2A:** The application circuit can be broken up into three main functions as denoted in the colored dotted areas above: RF/IF diplexing (blue), IF amplifier matching (green), and dc biasing (purple). There are various placeholders for chip components in the circuit schematic so that a common PCB can be used for all WJ dual-branch converters. Further details are given in the Application Note located on the website titled "CV2xx Series - PWB Design Guidelines".

**External Diplexer:** This is only used with the cellular-band CV products. The mixer performs the diplexing internally for the CV211-2A; therefore the components shown in the diplexer section should be not be loaded except for L3, L10, L7, and L11, which should contain a 0 Ω jumper.

**IF Amplifier Matching:** The IF amplifier requires matching elements to optimize the performance of the amplifier to the desired IF center frequency. Since IF bandwidths are typically on the order of 5 to 10%, a simple two element matching network, in the form of either a high-pass or low-pass filter structure, is sufficient to match the MMIC IF amplifier over these narrow bandwidths. Proper component values for other IF center frequencies can be provided by emailing to [applications.engineering@wj.com](mailto:applications.engineering@wj.com).

**DC biasing:** DC bias must be provided for the LO and IF amplifiers in the converter. R1 sets the operating current for the last stage of the LO amplifier and is chosen to optimize the mixer LO drive level. Proper RF chokes and bypass capacitors are chosen for proper amplifier biasing at the intended frequency of operation. The "+5 V" dc bias should be supplied directly from a voltage regulator.

Specifications and information are subject to change without notice



# CV211-2A

UMTS-band Dual-Branch Downconverter

The Communications Edge™

Product Information

Application Circuit: IF = 75 MHz (CV211-2APCB75)

RF = 1900 – 2200 MHz, IF = 75 MHz

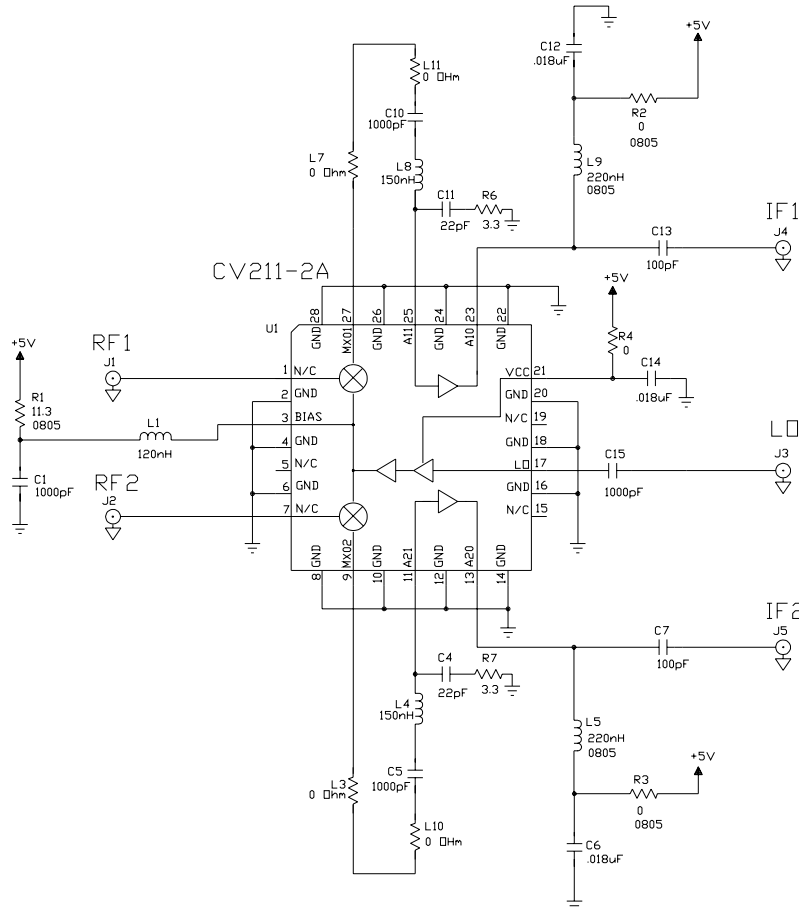

### PCB Layout

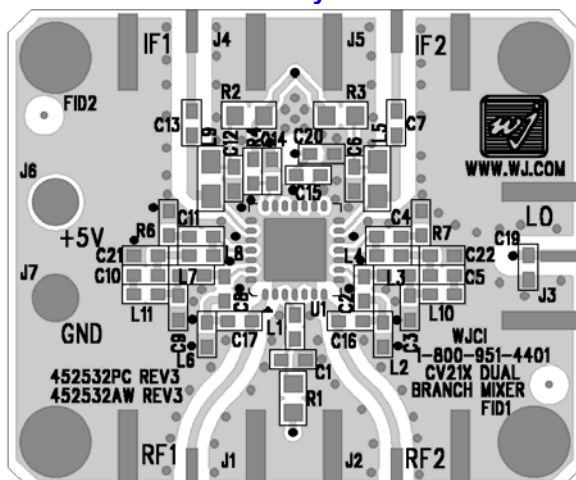

Circuit Board Material: .014" FR-4, 4 layers, .062" total thickness

### Bill of Materials

Ref. Desig.	Component	Size
R1	11.3 Ω chip resistor	0805
R2, R3, R4, L3, L7 L10, L11	0 Ω chip resistor	0603
R6, R7	3.3 Ω chip resistor	0603
C1, C5, C10, C15	1000 pF chip capacitor	0603
C4, C11	22 pF chip capacitor	0603
C6, C12, C14	.018 μF chip capacitor	0603
C7, C13	100 pF chip capacitor	0603
L1	120 nH chip inductor	0603
L4, L8	150 nH chip inductor	0603
L5, L9	220 nH chip inductor	0805
C2, C3, C8, C9, C16 C17, C19, C20, C21 C22, L2, L6	Shown on silkscreen, but not used in actual circuit.	
U1	CV211-2A WJ Converter	QFN

Specifications and information are subject to change without notice



# CV211-2A

UMTS-band Dual-Branch Downconverter

The Communications Edge™

Product Information

## CV211-2APCB75 Application Circuit Performance Plots

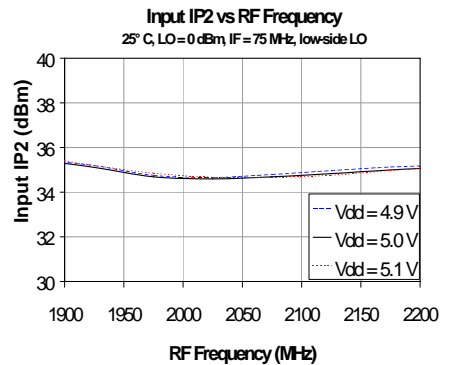
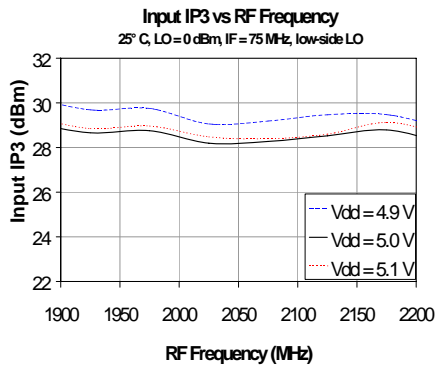
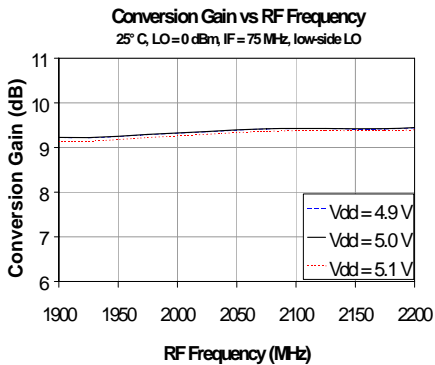
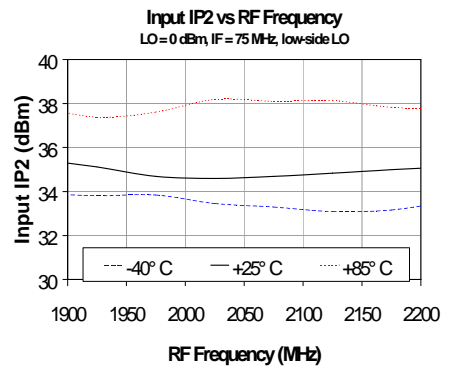
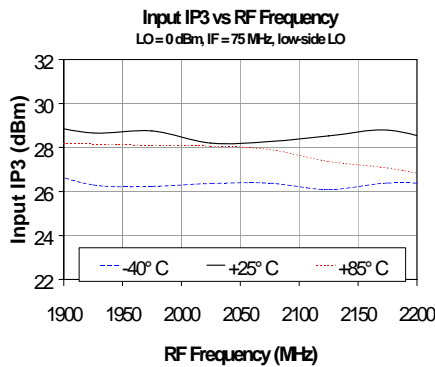
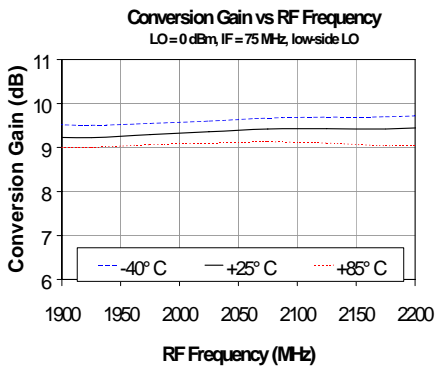
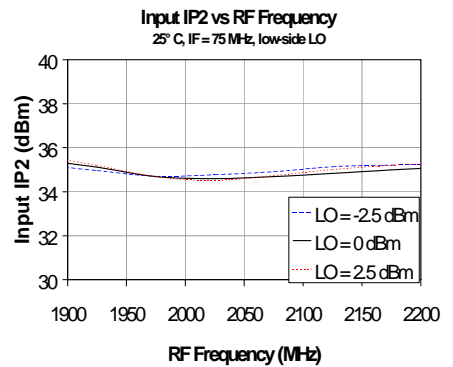
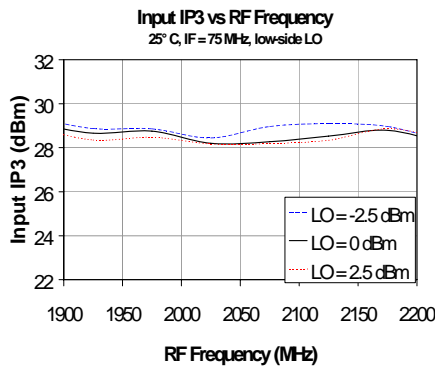
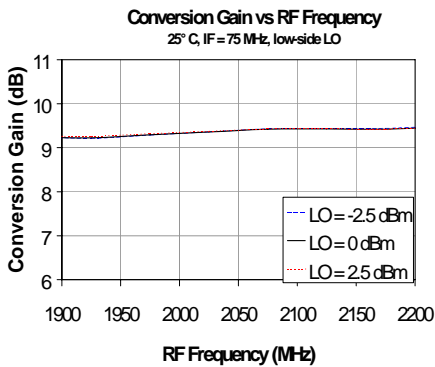
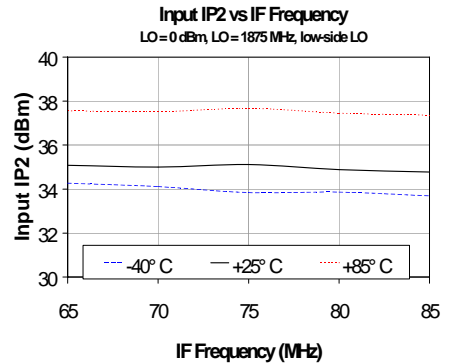
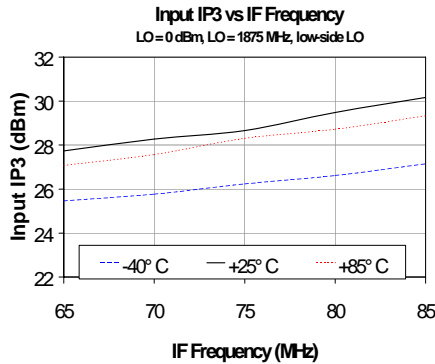
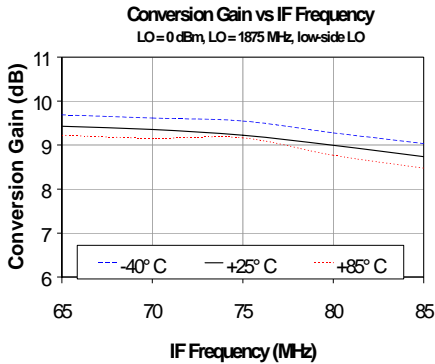



# CV211-2A

UMTS-band Dual-Branch Downconverter

The Communications Edge™

Product Information

## CV211-2APCB75 Application Circuit Performance Plots (cont'd)

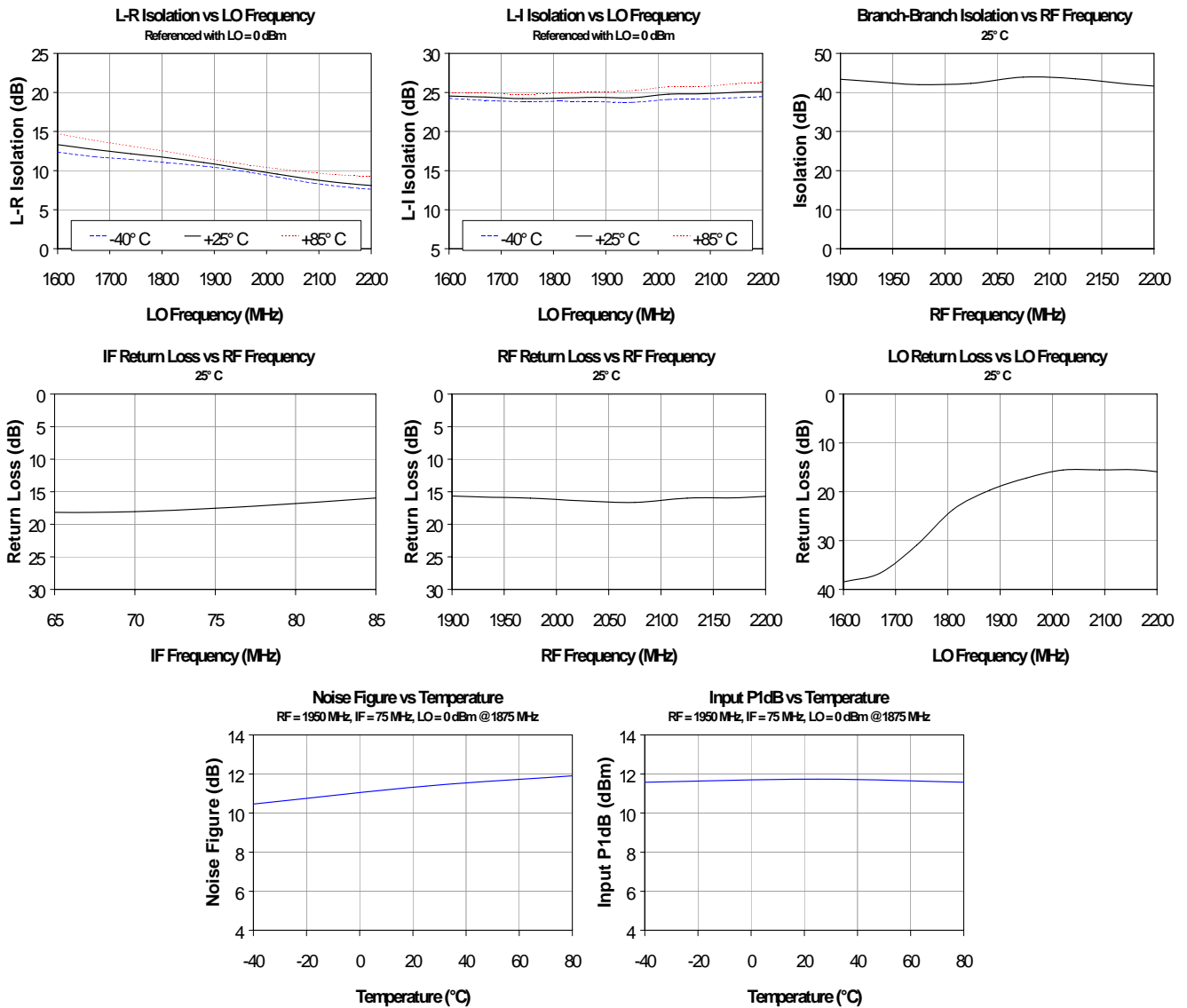



# CV211-2A

UMTS-band Dual-Branch Downconverter

The Communications Edge™

Product Information

## Application Circuit: IF = 240 MHz (CV211-2APCB240)

RF = 1900 – 2200 MHz, IF = 240 MHz

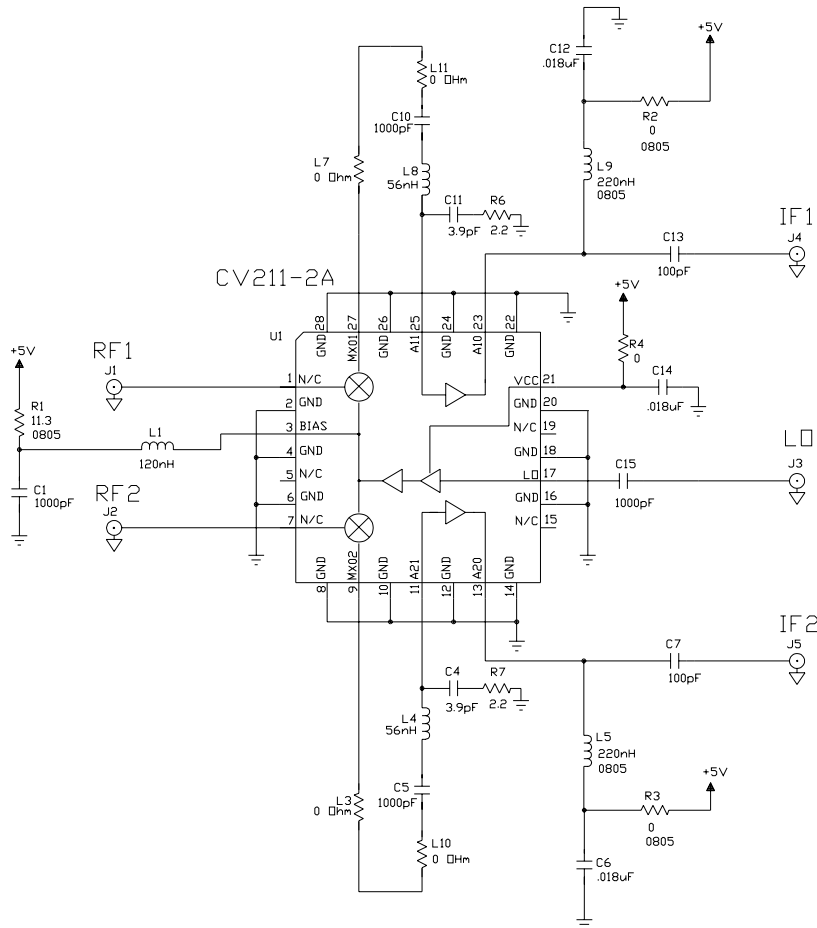

### PCB Layout

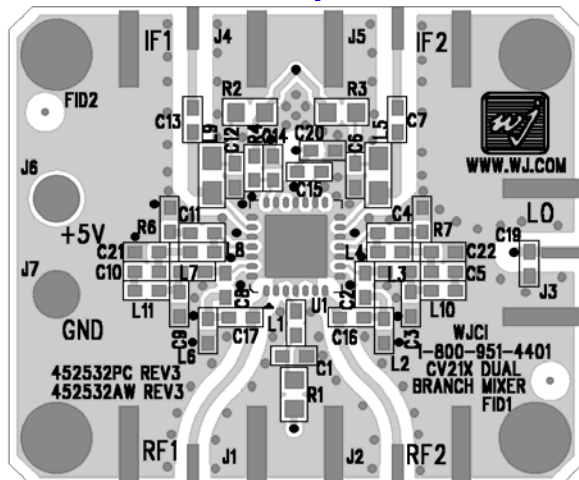

Circuit Board Material: .014" FR-4, 4 layers, .062" total thickness

### Bill of Materials

Ref. Desig.	Component	Size
R1	11.3 Ω chip resistor	0805
R2, R3, R4, L3, L7 L10, L11	0 Ω chip resistor	0603
R6, R7	2.2 Ω chip resistor	0603
C1, C5, C10, C15	1000 pF chip capacitor	0603
C4, C11	3.9 pF chip capacitor	0603
C6, C12, C14	.018 μF chip capacitor	0603
C7, C13	100 pF chip capacitor	0603
L1	120 nH chip inductor	0603
L4, L8	56 nH chip inductor	0603
L5, L9	220 nH chip inductor	0805
C2, C3, C8, C9, C16 C17, C19, C20, C21 C22, L2, L6	Shown on silkscreen, but not used in actual circuit.	
U1	CV211-2A WJ Converter	QFN

Specifications and information are subject to change without notice



# CV211-2A

UMTS-band Dual-Branch Downconverter

The Communications Edge™

Product Information

## CV211-2APCB240 Application Circuit Performance Plots

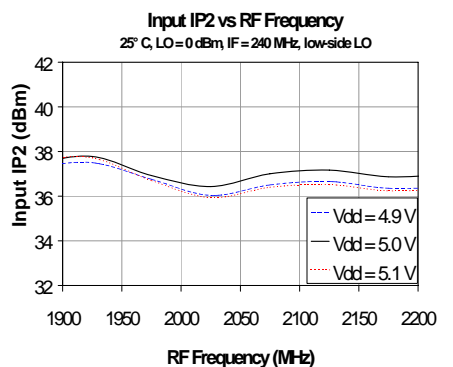
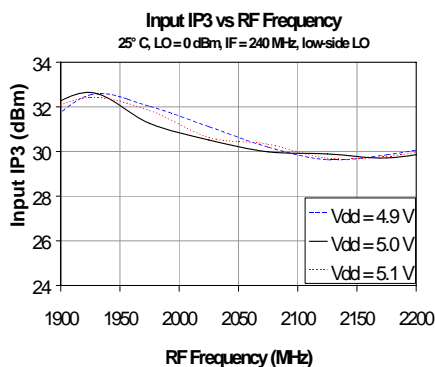
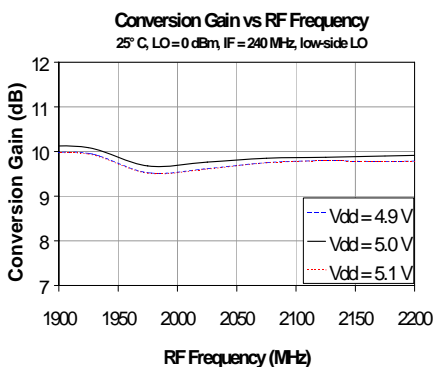
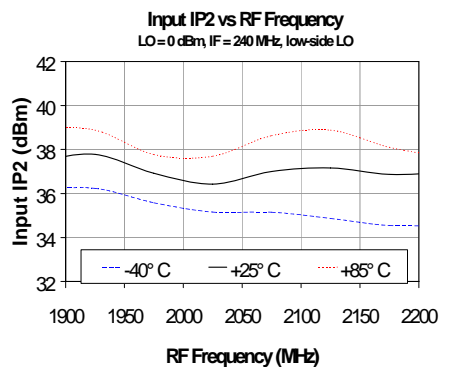
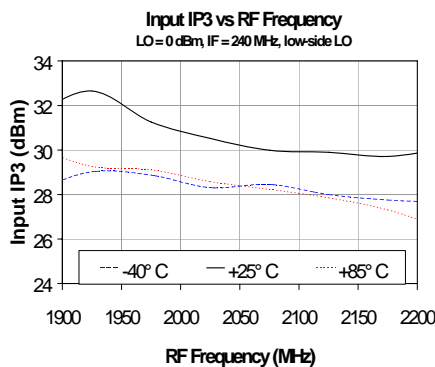
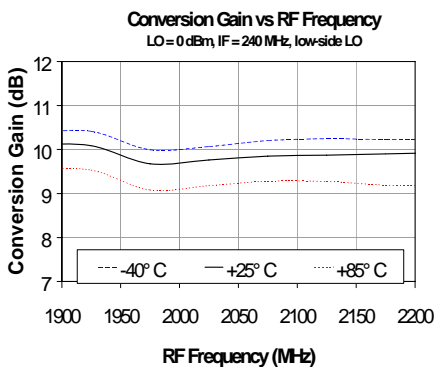
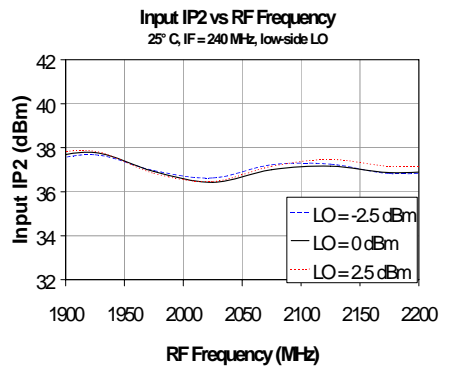
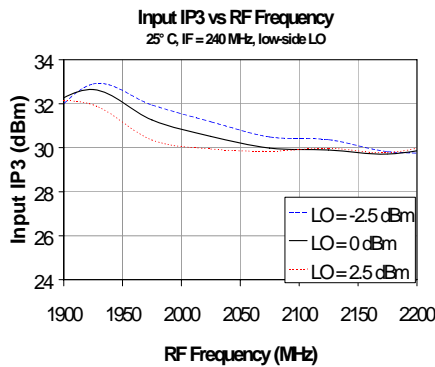
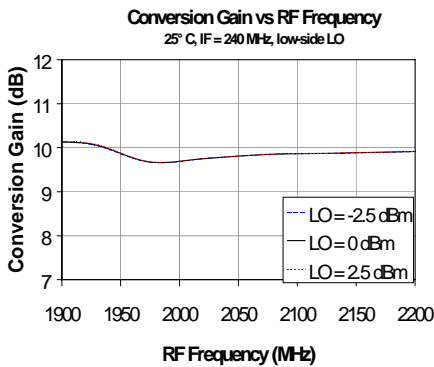
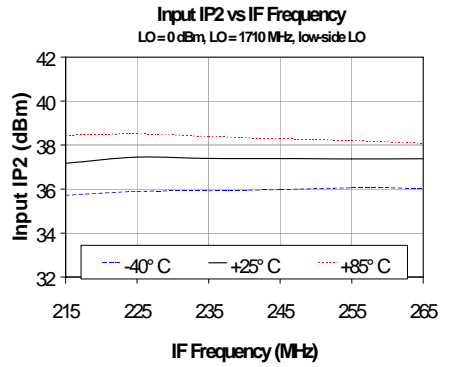
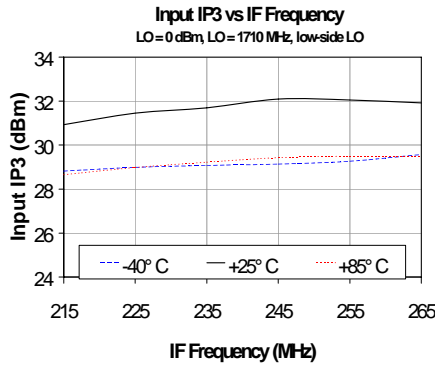
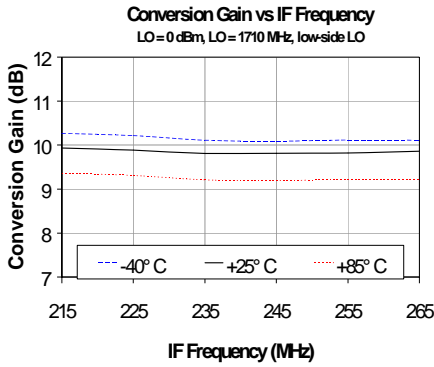



# CV211-2A

UMTS-band Dual-Branch Downconverter

The Communications Edge™

Product Information

## CV211-2APCB240 Application Circuit Performance Plots (cont'd)

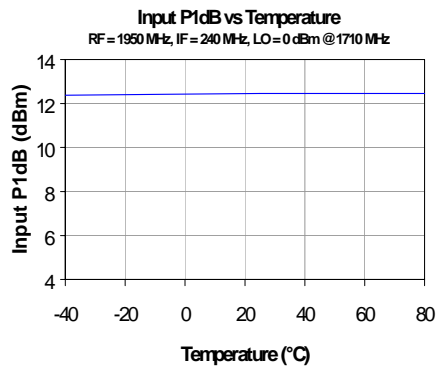
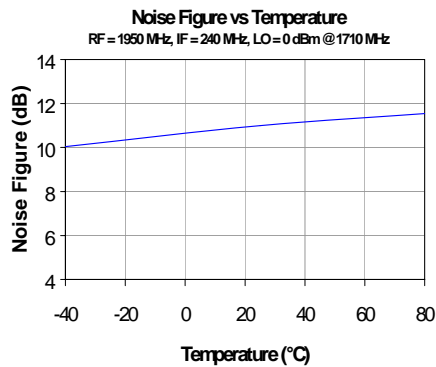
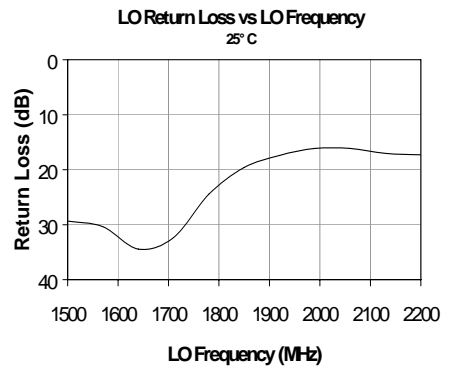
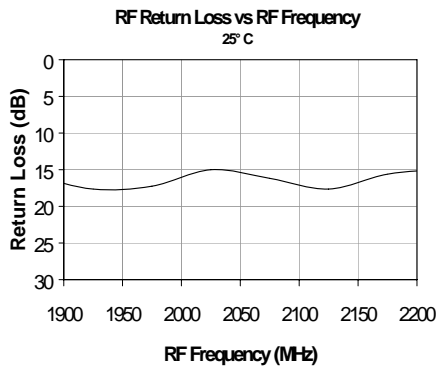
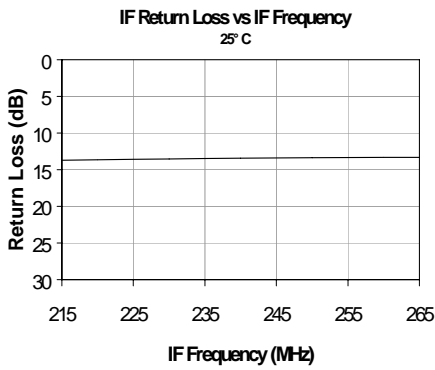
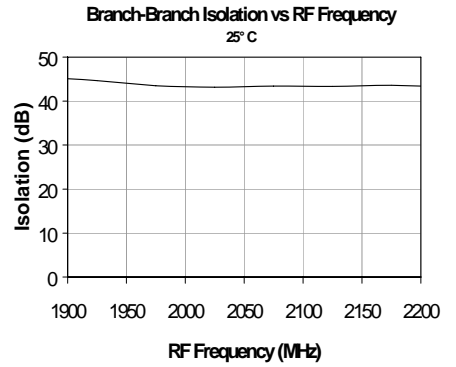
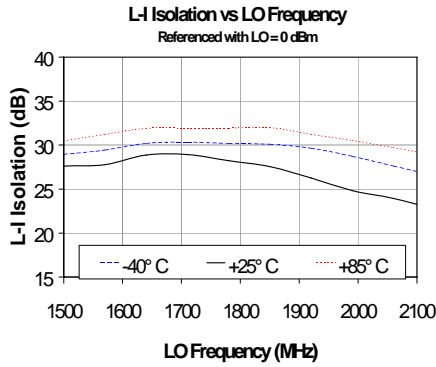
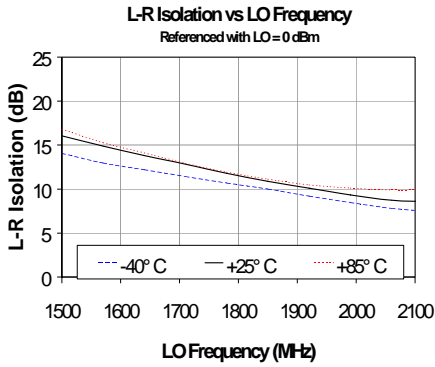





# CV211-2A

## UMTS-band Dual-Branch Downconverter

The Communications Edge™

Product Information

### CV211-2AF Mechanical Information

This package is lead-free/RoHS-compliant. It is compatible with both lead-free (maximum 260°C reflow temperature) and leaded (maximum 245°C reflow temperature) soldering processes. The plating material on the pins is annealed matte tin over copper.

#### Outline Drawing

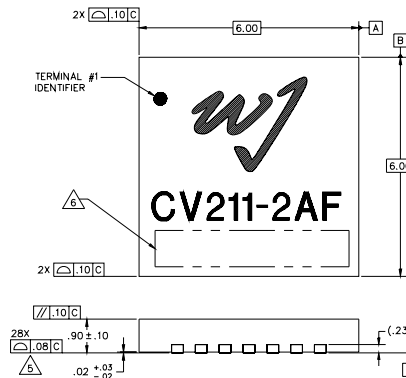

- NOTES:
- EXCEPT WHERE NOTED, THIS PART OUTLINE CONFORMS TO JEDEC STANDARD MO-220, ISSUE E (VARIATION VJJC) FOR THERMALLY ENHANCED PLASTIC VERY THIN FINE PITCH QUAD FLAT NO LEAD PACKAGE (QFN).
  - DIMENSIONING & TOLERANCING CONFORM TO ASME Y14.4M-1994.
  - ALL DIMENSIONS ARE IN MILLIMETERS. ANGLES ARE IN DEGREES.
  - THE TERMINAL #1 IDENTIFIER AND TERMINAL NUMBERING CONVENTION CONFORM TO JEDEC 95-1 SPP-012.
  - COPLANARITY APPLIES TO THE EXPOSED GROUND/THERMAL PAD AS WELL AS THE TERMINALS.
  - ALPHA-NUMERIC LOT CODE.

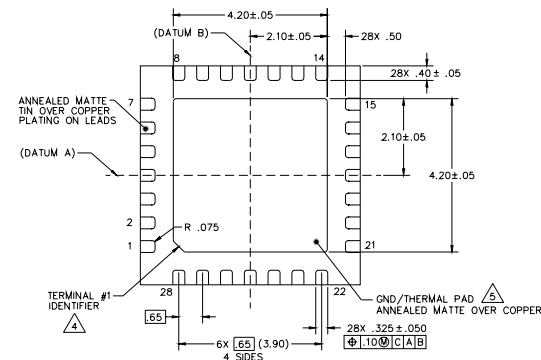

#### Product Marking

The component will be lasermarked with a "CV211-2AF" product label with an alphanumeric lot code on the top surface of the package.

Tape and reel specifications for this part will be located on the website in the "Application Notes" section.

#### ESD / MSL Information



Caution! ESD sensitive device.

ESD Rating: Class 1B  
 Value: Passes ≥ 500V to <1000V  
 Test: Human Body Model (HBM)  
 Standard: JEDEC Standard JESD22-A114

ESD Rating: Class III  
 Value: Passes ≥ 500V to <1000V  
 Test: Charged Device Model (CDM)  
 Standard: JEDEC Standard JESD22-C101

MSL Rating: Level 2 at +260°C convection reflow  
 Standard: JEDEC Standard J-STD-020

#### Mounting Configuration / Land Pattern

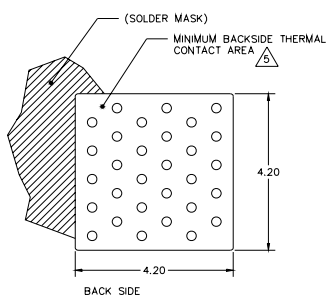
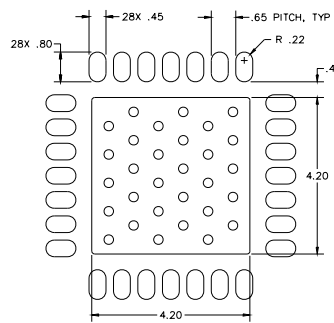
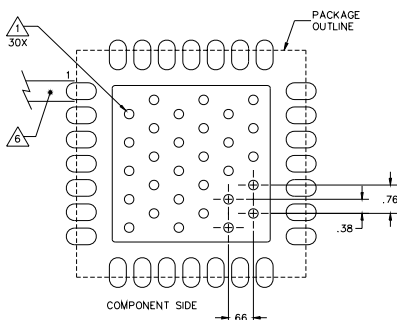

- NOTES:
- GROUND/THERMAL VIAS ARE CRITICAL FOR THE PROPER PERFORMANCE OF THIS DEVICE. VIAS SHOULD USE A .35mm (#80/.0135") DIAMETER DRILL AND HAVE A FINAL PLATED THRU DIAMETER OF .25mm (.010").
  - ADD AS MUCH COPPER AS POSSIBLE TO INNER AND OUTER LAYERS NEAR THE PART TO ENSURE OPTIMAL THERMAL PERFORMANCE.
  - TO ENSURE RELIABLE OPERATION, DEVICE GROUND PADDLE-TO-GROUND PAD SOLDER JOINT IS CRITICAL.
  - ADD MOUNTING SCREWS NEAR THE PART TO FASTEN THE BOARD TO A HEATSINK. ENSURE THAT THE GROUND/THERMAL VIA REGION CONTACTS THE HEATSINK.
  - DO NOT PUT SOLDER MASK ON THE BACK SIDE OF THE PC BOARD IN THE REGION WHERE THE BOARD CONTACTS THE HEATSINK.
  - RF TRACE WIDTH DEPENDS UPON THE PC BOARD MATERIAL AND CONSTRUCTION.
  - USE 1 OZ. COPPER MINIMUM.
  - ALL DIMENSIONS ARE IN MILLIMETERS. ANGLES ARE IN DEGREES.

#### Functional Pin Layout

Pin	Function	Pin	Function
1	Channel 1 Mixer RF Input	15	N/C or GND
2	GND	16	GND
3	LO Amp Bias	17	LO input
4	GND	18	GND
5	N/C or GND	19	N/C or GND
6	GND	20	GND
7	Channel 2 Mixer / RF Input	21	+5 V
8	GND	22	GND
9	Channel 2 Mixer / IF Output	23	Channel 1 IF Amp Output / Bias
10	GND	24	GND
11	Channel 2 IF Amp Input	25	Channel 1 IF Amp Input
12	GND	26	GND
13	Channel 2 IF Amp Output / Bias	27	Channel 1 Mixer IF Output
14	GND	28	GND

Specifications and information are subject to change without notice