



Features

- Lead free versions available
 - RoHS compliant (lead free version)*
 - Reverse voltage from 20 to 60 V
 - Forward current of 1 A
 - High current capability
- For use in low voltage high frequency inverters, free wheeling and polarity protection applications

CD214B-B120 ~ B160 Schottky Barrier Rectifier Chip Diode

General Information

The markets of portable communications, computing and video equipment are challenging the semiconductor industry to develop increasingly smaller electronic components.

Bourns offers Schottky Rectifier Diodes for rectification applications, in compact chip package DO-214AA (SMB) size format, which offer PCB real estate savings and are considerably smaller than most competitive parts. The Schottky Rectifier Diodes offer a forward current of 1 A with a choice of repetitive peak reverse voltage of 20 V up to 60 V.

Bourns® Chip Diodes conform to JEDEC standards, are easy to handle with standard pick and place equipment and the flat configuration minimizes roll away.

Electrical Characteristics (@ T_A = 25 °C Unless Otherwise Noted)

Parameter	Symbol	CD214B-					Unit
		B120	B130	B140	B150	B160	
Forward Voltage (Max.) (I _f = 2 A)	V _F	0.5	0.5	0.5	0.7	0.7	V
Typical Junction Capacitance*	C _T	110					pF
Reverse Current (Max.) at Rated V _R)	I _R	0.5					mA

* Measured at 1.0 MHz and applied reverse voltage of 4.0 V DC.

Absolute Ratings (@ T_A = 25 °C Unless Otherwise Noted)

Parameter	Symbol	CD214B-					Unit
		B120	B130	B140	B150	B160	
Repetitive Peak Reverse Voltage	V _{RRM}	20	30	40	50	60	V
Reverse Voltage	V _R	20	30	40	50	60	V
Maximum RMS Voltage	V _{RMS}	14	21	28	35	42	V
Avg. Forward Current	I _O	1					A
Forward Current, Surge Peak (60 Hz, 1 cycle)	I _{surge}	30					A
Typical Thermal Resistance**	R _{θJL}	20					°C/W
Storage Temperature	T _{STG}	-55 to +150					°C
Junction Temperature	T _J	-55 to +125					°C

** Thermal resistance junction to lead.



Reliable Electronic Solutions

Asia-Pacific:

Tel: +886-2 2562-4117 • Fax: +886-2 2562-4116

Europe:

Tel: +41-41 768 5555 • Fax: +41-41 768 5510

The Americas:

Tel: +1-951 781-5500 • Fax: +1-951 781-5700

www.bourns.com

CD214B-B120 ~ B160 Schottky Barrier Rectifier Chip Diode



Product Dimensions

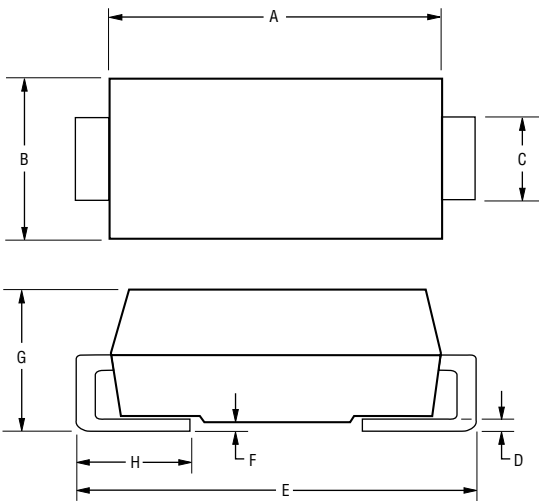

Dimension	SMB (DO-214AA)
A	$\frac{4.06 - 4.57}{(0.160 - 0.180)}$
B	$\frac{3.30 - 3.94}{(0.130 - 0.155)}$
C	$\frac{1.96 - 2.21}{(0.078 - 0.087)}$
D	$\frac{0.15 - 0.31}{(0.006 - 0.112)}$
E	$\frac{5.21 - 5.59}{(0.205 - 0.220)}$
F	$\frac{0.05 - 0.20}{(0.002 - 0.008)}$
G	$\frac{2.01 - 2.62}{(0.080 - 0.103)}$
H	$\frac{0.76 - 1.52}{(0.030 - 0.060)}$

DIMENSIONS: $\frac{\text{MM}}{\text{(INCHES)}}$

Recommended Pad Layout

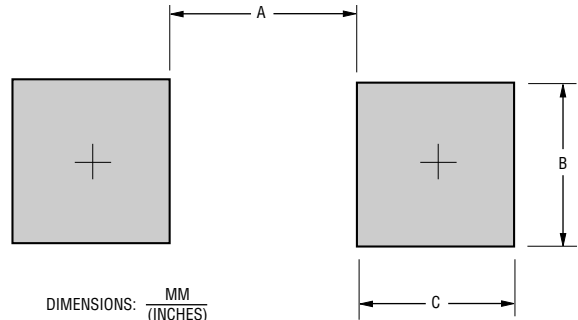

DIMENSIONS: $\frac{\text{MM}}{\text{(INCHES)}}$

Dimension	SMB (DO-214AA)
A (Max.)	$\frac{2.69}{(0.106)}$
B (Min.)	$\frac{2.10}{(0.083)}$
C (Min.)	$\frac{1.27}{(0.050)}$

Physical Specifications

CaseMolded plastic
 PolarityIndicated by cathode band
 Weight0.003 ounces / 0.093 grams

Typical Part Marking

CD214B-B220 **B 120B**
 CD214B-B230 **B 130B**
 CD214B-B240 **B 140B**
 CD214B-B250 **B 150B**
 CD214B-B260 **B 160B**

How To Order

CD 214B - B 1 30

Common Code _____
 Chip Diode _____
 Package _____
 • 214B = SMB/DO-214AA
 Model _____
 B = Schottky Barrier Series
 Average Forward Current (I_O) Code _____
 1 = 1 A (Code x 1000 mA = Average Forward Current)
 Reverse Voltage (V_R) Code _____
 20 = 20 V
 30 = 30 V
 40 = 40 V
 50 = 50 V
 60 = 60 V
 Terminations _____
 LF = 100 % Sn (lead free)
 Blank = Sn/Pb

*RoHS Directive 2002/95/EC Jan 27 2003 including Annex
 Specifications are subject to change without notice.
 Customers should verify actual device performance in their specific applications.

CD214B-B120 ~ B160 Schottky Barrier Rectifier Chip Diode



Rating and Characteristic Curves

Forward Current Derating Curve

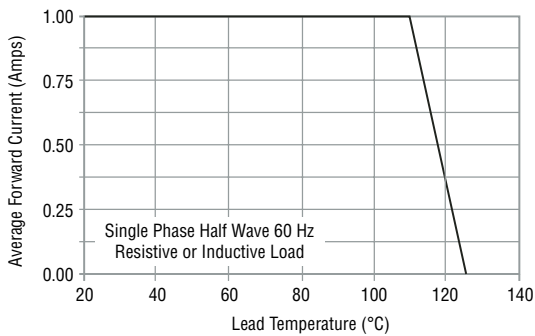

Maximum Non-Repetitive Surge Current

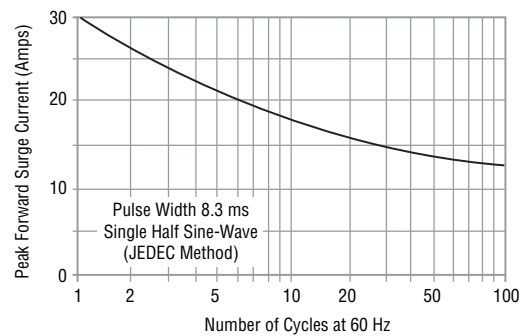

Typical Forward Characteristics

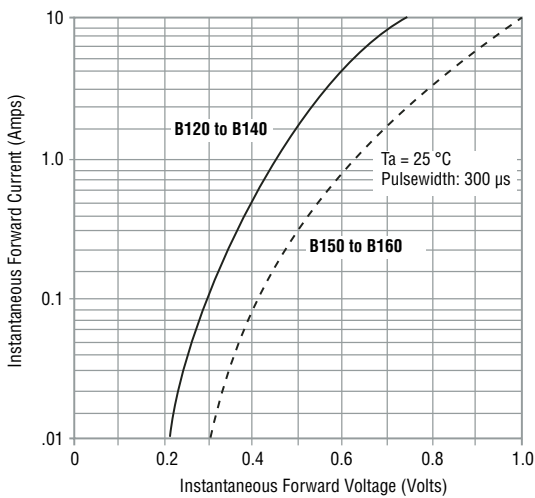

Typical Junction Capacitance

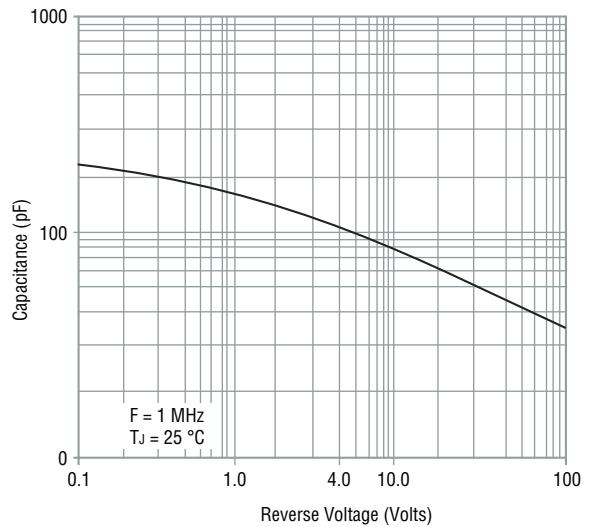

Typical Reverse Characteristics

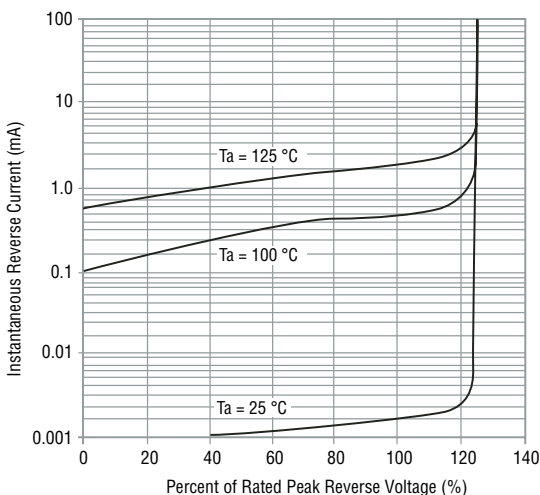

*RoHS Directive 2002/95/EC Jan 27 2003 including Annex
Specifications are subject to change without notice.
Customers should verify actual device performance in their specific applications.

CD214B-B120 ~ B160 Schottky Barrier Rectifier Chip Diode



Packaging Information

The product will be dispensed in Tape and Reel format (see diagram below).

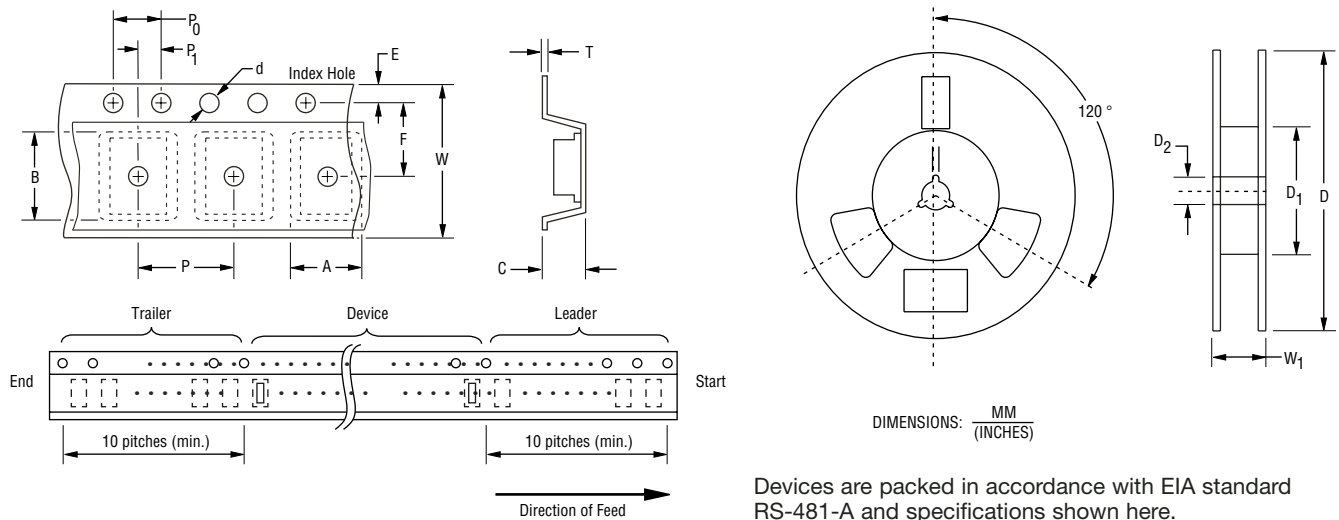

Item	Symbol	SMB (DO-214AA)
Carrier Width	A	$\frac{4.94 \pm 0.10}{(0.194 - 0.004)}$
Carrier Length	B	$\frac{5.57 \pm 0.10}{(0.219 - 0.004)}$
Carrier Depth	C	$\frac{2.36 \pm 0.10}{(0.093 - 0.004)}$
Sprocket Hole	d	$\frac{1.55 \pm 0.05}{(0.061 - 0.002)}$
Reel Outside Diameter	D	$\frac{330}{(12.992)}$
Reel Inner Diameter	D ₁	$\frac{50.0}{(1.969)}$ MIN.
Feed Hole Diameter	D ₂	$\frac{13.0 \pm 0.20}{(0.512 - 0.008)}$
Sprocket Hole Position	E	$\frac{1.75 \pm 0.10}{(0.069 - 0.004)}$
Punch Hole Position	F	$\frac{5.50 \pm 0.05}{(0.217 - 0.002)}$
Punch Hole Pitch	P	$\frac{4.00 \pm 0.10}{(0.157 - 0.004)}$
Sprocket Hole Pitch	P ₀	$\frac{4.00 \pm 0.10}{(0.157 - 0.004)}$
Embossment Center	P ₁	$\frac{2.00 \pm 0.05}{(0.079 - 0.002)}$
Overall Tape Thickness	T	$\frac{0.30 \pm 0.10}{(0.012 - 0.004)}$
Tape Width	W	$\frac{12.00 \pm 0.20}{(0.472 - 0.008)}$
Reel Width	W ₁	$\frac{18.4}{(0.724)}$ MAX.
Quantity per Reel	--	3,000

*RoHS Directive 2002/95/EC Jan 27 2003 including Annex Specifications are subject to change without notice.

Customers should verify actual device performance in their specific applications.