

## SINGLE-POLE DOUBLE-THROW (SPDT) ANALOG SWITCH OR 2:1 ANALOG MULTIPLEXER/DEMULTIPLEXER

### FEATURES

- Available in the Texas Instruments NanoFree™ Package
- Operates at 0.8 V to 2.7 V
- Sub-1-V Operable
- Low Power Consumption, 10  $\mu$ A at 2.7 V
- High On-Off Output Voltage Ratio
- High Degree of Linearity
- Latch-Up Performance Exceeds 100 mA Per JESD 78, Class II
- ESD Protection Exceeds JESD 22
  - 2000-V Human-Body Model (A114-A)
  - 200-V Machine Model (A115-A)
  - 1000-V Charged-Device Model (C101)

DCT OR DCU PACKAGE  
(TOP VIEW)

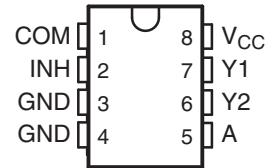

YZP PACKAGE

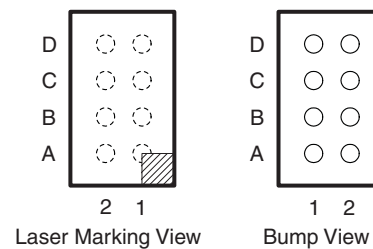

**YZP TERMINAL ASSIGNMENTS**

<b>D</b>	GND	A
<b>C</b>	GND	Y2
<b>B</b>	INH	Y1
<b>A</b>	COM	V <sub>CC</sub>
	1	2

### DESCRIPTION/ORDERING INFORMATION

This analog switch is operational at 0.8-V to 2.7-V V<sub>CC</sub>, but is designed specifically for 1.1-V to 2.7-V V<sub>CC</sub> operation.

The SN74AUC2G53 can handle both analog and digital signals. The device permits signals with amplitudes of up to V<sub>CC</sub> (peak) to be transmitted in either direction.

NanoFree™ package technology is a major breakthrough in IC packaging concepts, using the die as the package.

Applications include signal gating, chopping, modulation or demodulation (modem), and signal multiplexing for analog-to-digital and digital-to-analog conversion systems.



Please be aware that an important notice concerning availability, standard warranty, and use in critical applications of Texas Instruments semiconductor products and disclaimers thereto appears at the end of this data sheet.

NanoFree is a trademark of Texas Instruments.

**ORDERING INFORMATION**

T <sub>A</sub>	PACKAGE <sup>(1)(2)</sup>		ORDERABLE PART NUMBER	TOP-SIDE MARKING <sup>(3)</sup>
-40C to 85C	NanoFree™ – WCSP (DSBGA) 0.23-mm Large Bump – YZP (Pb-free)	Reel of 3000	SN74AUC2G53YZPR	___U4_
	SSOP – DCT	Reel of 3000	SN74AUC2G53DCTR	U53___
	VSSOP – DCU	Reel of 3000	SN74AUC2G53DCUR	U53_

- (1) For the most current package and ordering information, see the Package Option Addendum at the end of this document, or see the TI web site at [www.ti.com](http://www.ti.com).
- (2) Package drawings, thermal data, and symbolization are available at [www.ti.com/packaging](http://www.ti.com/packaging).
- (3) DCT: The actual top-side marking has three additional characters that designate the year, month, and assembly/test site.  
DCU: The actual top-side marking has one additional character that designates the assembly/test site.  
YZP: The actual top-side marking has three preceding characters to denote year, month, and sequence code, and one following character to designate the assembly/test site. Pin 1 identifier indicates solder-bump composition (1 = SnPb, • = Pb-free).

**FUNCTION TABLE**

CONTROL INPUTS		ON CHANNEL
INH	A	
L	L	Y1
L	H	Y2
H	X	None

**LOGIC DIAGRAM (POSITIVE LOGIC)**

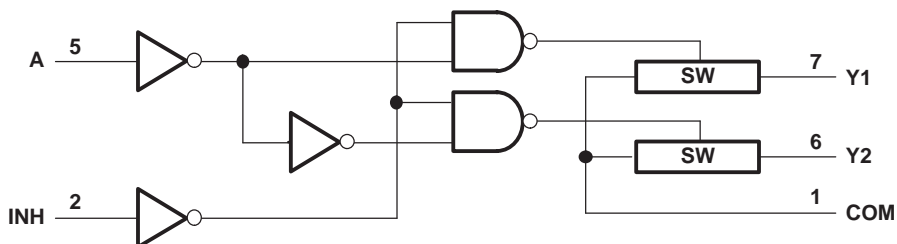

NOTE A: For simplicity, the test conditions shown in Figures 1 through 4 and 6 through 10 are for the demultiplexer configuration. Signals may be passed from COM to Y1 (Y2) or from Y1 (Y2) to COM.

**SIMPLIFIED SCHEMATIC, EACH SWITCH (SW)**

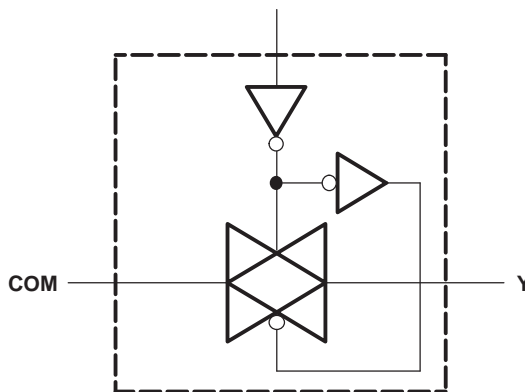

## Absolute Maximum Ratings<sup>(1)</sup>

over operating free-air temperature range (unless otherwise noted)

		MIN	MAX	UNIT
V <sub>CC</sub>	Supply voltage range <sup>(2)</sup>	–0.5	3.6	V
V <sub>I</sub>	Input voltage range <sup>(2)(3)</sup>	–0.5	3.6	V
V <sub>I/O</sub>	Switch I/O voltage range <sup>(2)(3)</sup>	–0.5	V <sub>CC</sub> + 0.5	V
I <sub>IK</sub>	Control input clamp current	V <sub>I</sub> < 0	–50	mA
I <sub>I/O</sub> K	I/O port diode current	V <sub>I/O</sub> < 0 or V <sub>I/O</sub> > V <sub>CC</sub>	50	mA
I <sub>T</sub>	On-state switch current	V <sub>I/O</sub> = 0 to V <sub>CC</sub>	50	mA
	Continuous current through V <sub>CC</sub> or GND		100	mA
θ <sub>JA</sub>	Package thermal impedance <sup>(4)</sup>	DCT package	220	C/W
		DCU package	227	
		YZP package	102	
T <sub>stg</sub>	Storage temperature range	–65	150	C

- (1) Stresses beyond those listed under "absolute maximum ratings" may cause permanent damage to the device. These are stress ratings only, and functional operation of the device at these or any other conditions beyond those indicated under "recommended operating conditions" is not implied. Exposure to absolute-maximum-rated conditions for extended periods may affect device reliability.
- (2) All voltages are with respect to ground unless otherwise specified.
- (3) The input negative-voltage and output voltage ratings may be exceeded if the input and output current ratings are observed.
- (4) The package thermal impedance is calculated in accordance with JESD 51-7.

## Recommended Operating Conditions<sup>(1)</sup>

		MIN	MAX	UNIT
V <sub>CC</sub>	Supply voltage	0.8	2.7	V
V <sub>IH</sub>	High-level input voltage	V <sub>CC</sub> = 0.8 V	V <sub>CC</sub>	V
		V <sub>CC</sub> = 1.1 V to 1.95 V	0.65 V <sub>CC</sub>	
		V <sub>CC</sub> = 2.3 V to 2.7 V	1.7	
V <sub>IL</sub>	Low-level input voltage	V <sub>CC</sub> = 0.8 V	0	V
		V <sub>CC</sub> = 1.1 V to 1.95 V	0.35 V <sub>CC</sub>	
		V <sub>CC</sub> = 2.3 V to 2.7 V	0.7	
V <sub>I/O</sub>	I/O port voltage	0	V <sub>CC</sub>	V
V <sub>I</sub>	Control input voltage	0	3.6	V
Δt/Δv	Input transition rise or fall rate	V <sub>CC</sub> = 0.8 V to 1.6 V	20	ns/V
		V <sub>CC</sub> = 1.65 V to 1.95 V	10	
		V <sub>CC</sub> = 2.3 V to 2.7 V	3.5	
T <sub>A</sub>	Operating free-air temperature	–40	85	C

- (1) All unused inputs of the device must be held at V<sub>CC</sub> or GND to ensure proper device operation. Refer to the TI application report, *Implications of Slow or Floating CMOS Inputs*, literature number SCBA004.

## Electrical Characteristics

over recommended operating free-air temperature range (unless otherwise noted)

PARAMETER	TEST CONDITIONS	V <sub>CC</sub>	MIN	TYP <sup>(1)</sup>	MAX	UNIT
		1.1 V				
r <sub>on</sub>	V <sub>I</sub> = V <sub>CC</sub> or GND, V <sub>INH</sub> = V <sub>IL</sub> (see Figure 1 and Figure 2)	I <sub>S</sub> = 4 mA			40	Ω
			1.65 V	12.5	20	
		I <sub>S</sub> = 8 mA	2.3 V	6	15	
r <sub>on(p)</sub>	V <sub>I</sub> = V <sub>CC</sub> to GND, V <sub>INH</sub> = V <sub>IL</sub> (see Figure 1 and Figure 2)	I <sub>S</sub> = 4 mA	1.1 V	131	180	Ω
			1.65 V	32	80	
		I <sub>S</sub> = 8 mA	2.3 V	15	20	

- (1) T<sub>A</sub> = 25°C

## Electrical Characteristics (continued)

over recommended operating free-air temperature range (unless otherwise noted)

PARAMETER		TEST CONDITIONS		V <sub>CC</sub>	MIN	TYP <sup>(1)</sup>	MAX	UNIT
$\Delta r_{on}$	Difference of on-state resistance between switches	$V_I = V_{CC}$ to GND, $V_C = V_{IH}$ (see Figure 1 and Figure 2)	$I_S = 4$ mA	1.1 V			4	$\Omega$
				1.65 V			1	
			$I_S = 8$ mA	2.3 V			1	
$I_{S(off)}$	Off-state switch leakage current	$V_I = V_{CC}$ and $V_O =$ GND, or $V_I =$ GND and $V_O = V_{CC}$ , $V_{INH} = V_{IH}$ (see Figure 3)		2.7 V			1	$\mu$ A
						0.1 <sup>(1)</sup>		
$I_{S(on)}$	On-state switch leakage current	$V_I = V_{CC}$ or GND, $V_{INH} = V_{IL}$ , $V_O =$ Open (see Figure 4)		2.7 V			1	$\mu$ A
						0.1 <sup>(1)</sup>		
$I_I$	Control input current	$V_C = V_{CC}$ or GND		2.7 V			5	$\mu$ A
$I_{CC}$	Supply current	$V_C = V_{CC}$ or GND		2.7 V			10	$\mu$ A
$C_{ic}$	Control input capacitance			2.5 V		2		pF
$C_{io(off)}$	Switch input/output capacitance	Y		2.5 V		3		pF
		COM			4.5			
$C_{io(on)}$	Switch input/output capacitance			2.5 V		9		pF

## Switching Characteristics

over recommended operating free-air temperature range,  $C_L = 15$  pF (unless otherwise noted) (see Figure 5)

PARAMETER	FROM (INPUT)	TO (OUTPUT)	V <sub>CC</sub> = 0.8 V	V <sub>CC</sub> = 1.2 V 0.1 V		V <sub>CC</sub> = 1.5 V 0.1 V		V <sub>CC</sub> = 1.8 V 0.15 V			V <sub>CC</sub> = 2.5 V 0.2 V		UNIT
			TYP	MIN	MAX	MIN	MAX	MIN	TYP	MAX	MIN	MAX	
$t_{pd}^{(1)}$	COM or Y	Y or COM	0.3		0.3					0.2		0.1	ns
$t_{en}$	INH	COM or Y	9.2	0.5	3.5	0.5	2.2	0.5	1	1.9	0.5	1.8	ns
$t_{dis}$			8.1	0.5	4.2	0.5	3.2	0.5	1.9	3.4	0.5	2.6	
$t_{en}$	A	COM or Y	9.2	0.5	3.6	0.5	2.3	0.5	1.1	1.9	0.5	1.6	ns
$t_{dis}$			10	0.5	3.6	0.5	2.3	0.5	1.1	2	0.5	1.6	

(1) The propagation delay is the calculated RC time constant of the typical on-state resistance of the switch and the specified load capacitance, when driven by an ideal voltage source (zero output impedance).

## Switching Characteristics

over recommended operating free-air temperature range,  $C_L = 30$  pF (unless otherwise noted) (see Figure 5)

PARAMETER	FROM (INPUT)	TO (OUTPUT)	V <sub>CC</sub> = 1.8 V 0.15 V			V <sub>CC</sub> = 2.5 V 0.2 V		UNIT
			MIN	TYP	MAX	MIN	MAX	
$t_{pd}^{(1)}$	COM or Y	Y or COM				0.4	0.2	ns
$t_{en}$	INH	COM or Y	0.5	1.6	3.1	0.5	2.2	ns
$t_{dis}$			0.5	2.2	3.4	0.5	2.2	
$t_{en}$	A	COM or Y	0.5	1.6	3	0.5	2.2	ns
$t_{dis}$			0.5	1.6	3	0.5	2.3	

(1) The propagation delay is the calculated RC time constant of the typical on-state resistance of the switch and the specified load capacitance, when driven by an ideal voltage source (zero output impedance).

## Analog Switch Characteristics

 $T_A = 25^\circ\text{C}$ 

PARAMETER	FROM (INPUT)	TO (OUTPUT)	TEST CONDITIONS	V <sub>CC</sub>	TYP	UNIT
Frequency response <sup>(1)</sup> (switch ON)	COM or Y	Y or COM	$C_L = 50\text{ pF}$ , $R_L = 600\ \Omega$ , $f_{in} = \text{sine wave}$ (see Figure 6)	0.8 V	90	MHz
				1.1 V	101	
				1.4 V	110	
				1.65 V	122	
				2.3 V	198	
			$C_L = 5\text{ pF}$ , $R_L = 50\ \Omega$ , $f_{in} = \text{sine wave}$ (see Figure 6)	0.8 V	>500	
				1.1 V	>500	
				1.4 V	>500	
				1.65 V	>500	
				2.3 V	>500	
Crosstalk <sup>(2)</sup> (between switches)	COM or Y	Y or COM	$C_L = 50\text{ pF}$ , $R_L = 600\ \Omega$ , $f_{in} = 1\text{ MHz (sine wave)}$ (see Figure 7)	0.8 V	-59	dB
				1.1 V	-59	
				1.4 V	-59	
				1.65 V	-59	
				2.3 V	-60	
			$C_L = 5\text{ pF}$ , $R_L = 50\ \Omega$ , $f_{in} = 1\text{ MHz (sine wave)}$ (see Figure 7)	0.8 V	-55	
				1.1 V	-55	
				1.4 V	-55	
				1.65 V	-55	
				2.3 V	-55	
Crosstalk (control input to signal output)	INH	COM or Y	$C_L = 50\text{ pF}$ , $R_L = 600\ \Omega$ , $f_{in} = 1\text{ MHz (square wave)}$ (see Figure 8)	0.8 V	0.56	mV
				1.1 V	0.68	
				1.4 V	0.81	
				1.65 V	0.93	
				2.3 V	1.5	
Feed-through attenuation <sup>(3)</sup> (switch OFF)	COM or Y	Y or COM	$C_L = 50\text{ pF}$ , $R_L = 600\ \Omega$ , $f_{in} = 1\text{ MHz (sine wave)}$ (see Figure 9)	0.8 V	-60	dB
				1.1 V	-60	
				1.4 V	-60	
				1.65 V	-60	
				2.3 V	-60	
			$C_L = 5\text{ pF}$ , $R_L = 600\ \Omega$ , $f_{in} = 1\text{ MHz (sine wave)}$ (see Figure 9)	0.8 V	-59	
				1.1 V	-59	
				1.4 V	-59	
				1.65 V	-59	
				2.3 V	-59	

(1) Adjust  $f_{in}$  voltage to obtain 0 dBm at output. Increase  $f_{in}$  frequency until dB meter reads -3 dB.

(2) Adjust  $f_{in}$  voltage to obtain 0 dBm at input.

(3) Adjust  $f_{in}$  voltage to obtain 0 dBm at input.

**Analog Switch Characteristics (continued)** $T_A = 25^\circ\text{C}$ 

PARAMETER	FROM (INPUT)	TO (OUTPUT)	TEST CONDITIONS	$V_{CC}$	TYP	UNIT
Sine-wave distortion	COM or Y	Y or COM	$C_L = 50\text{ pF}$ , $R_L = 10\text{ k}\Omega$ , $f_{in} = 1\text{ kHz}$ (sine wave) (see Figure 10)	0.8 V	6.19	%
				1.1 V	0.39	
				1.4 V	0.06	
				1.65 V	0.02	
				2.3 V	0.01	
			$C_L = 50\text{ pF}$ , $R_L = 10\text{ k}\Omega$ , $f_{in} = 10\text{ kHz}$ (sine wave) (see Figure 10)	0.8 V	3.55	
				1.1 V	0.38	
				1.4 V	0.04	
				1.65 V	0.02	
				2.3 V	0.02	

**Operating Characteristics**for INH input,  $T_A = 25^\circ\text{C}$ 

PARAMETER	TEST CONDITIONS	$V_{CC} = 0.8\text{ V}$	$V_{CC} = 1.2\text{ V}$	$V_{CC} = 1.5\text{ V}$	$V_{CC} = 1.8\text{ V}$	$V_{CC} = 2.5\text{ V}$	UNIT
		TYP	TYP	TYP	TYP	TYP	
$C_{pd}$ Power dissipation capacitance	$f = 10\text{ MHz}$	3	3	3	3	3	pF

**Operating Characteristics**for A input,  $T_A = 25^\circ\text{C}$ 

PARAMETER		TEST CONDITIONS	$V_{CC} = 0.8\text{ V}$	$V_{CC} = 1.2\text{ V}$	$V_{CC} = 1.5\text{ V}$	$V_{CC} = 1.8\text{ V}$	$V_{CC} = 2.5\text{ V}$	UNIT
			TYP	TYP	TYP	TYP	TYP	
$C_{pd}$ Power dissipation capacitance	Outputs enabled	$f = 10\text{ MHz}$	5.5	5.5	5.5	5.5	5.5	pF
	Outputs disabled		0.5	0.5	0.5	0.5	0.5	

PARAMETER MEASUREMENT INFORMATION

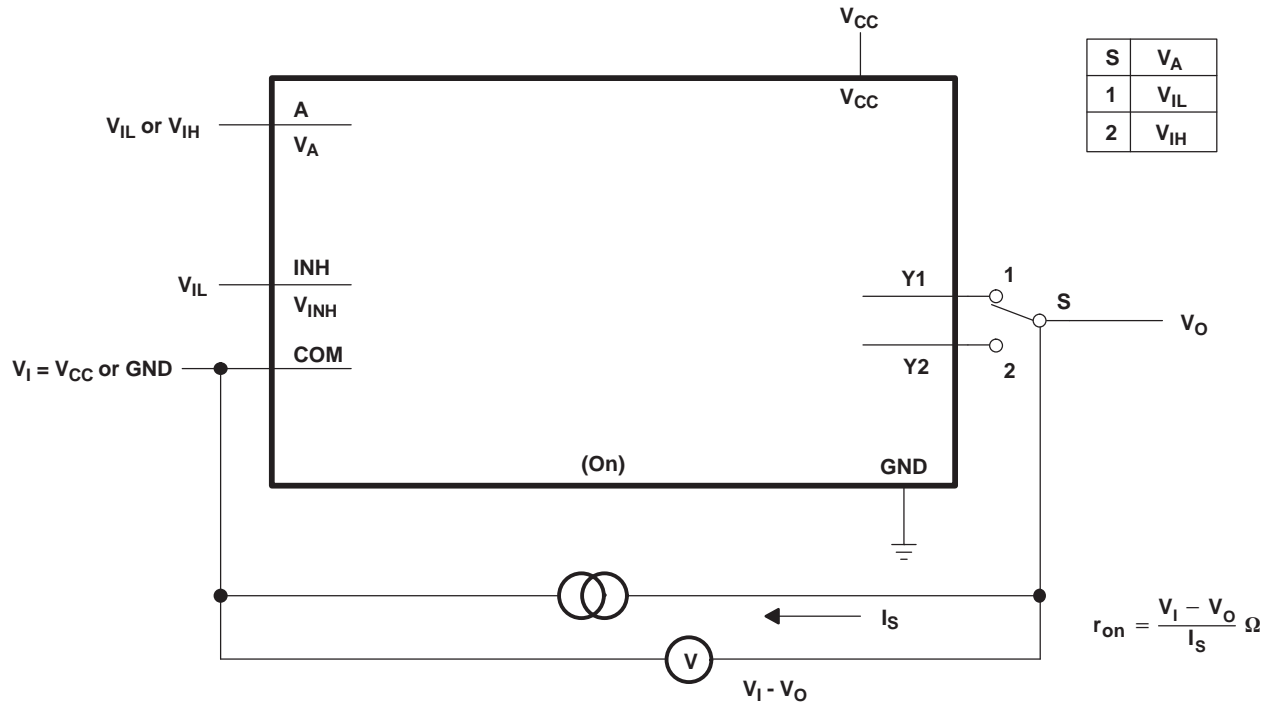

Figure 1. On-State Resistance Test Circuit

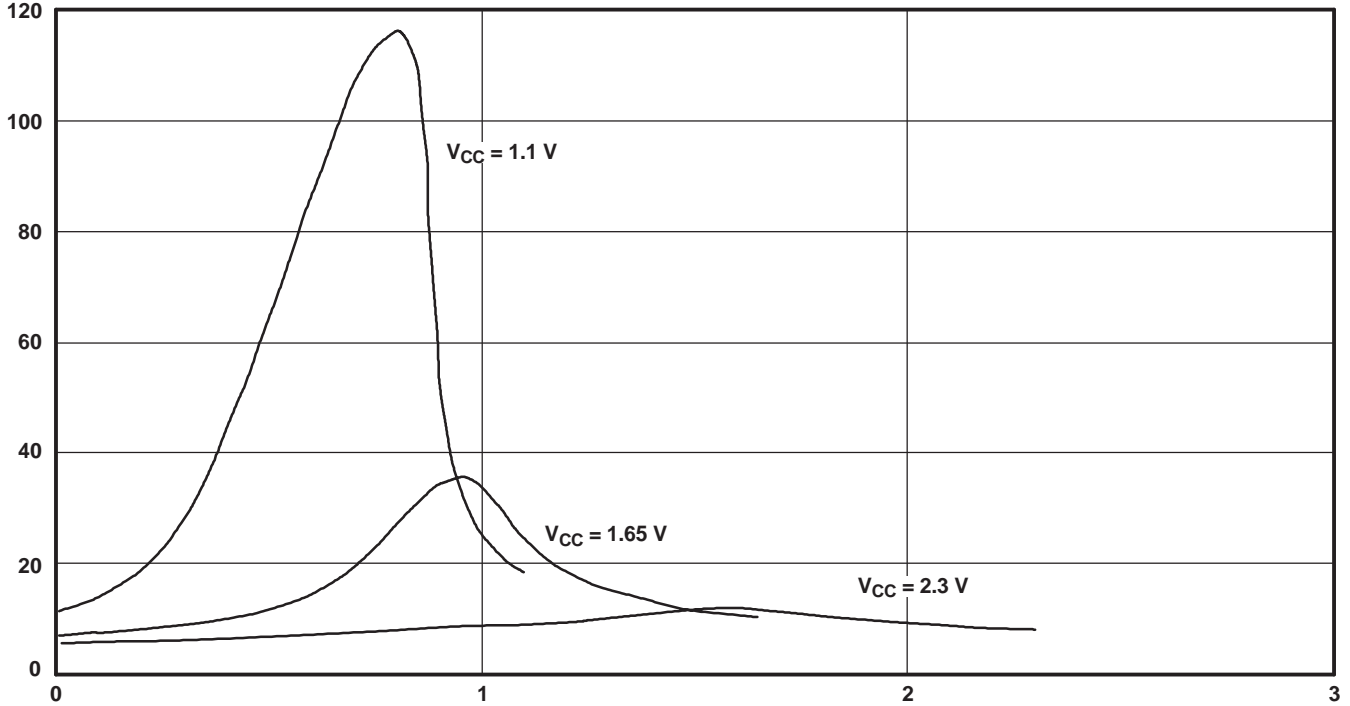

Figure 2. Typical  $r_{on}$  as a Function of Voltage ( $V_I$ ) for  $V_I = 0$  to  $V_{CC}$

PARAMETER MEASUREMENT INFORMATION

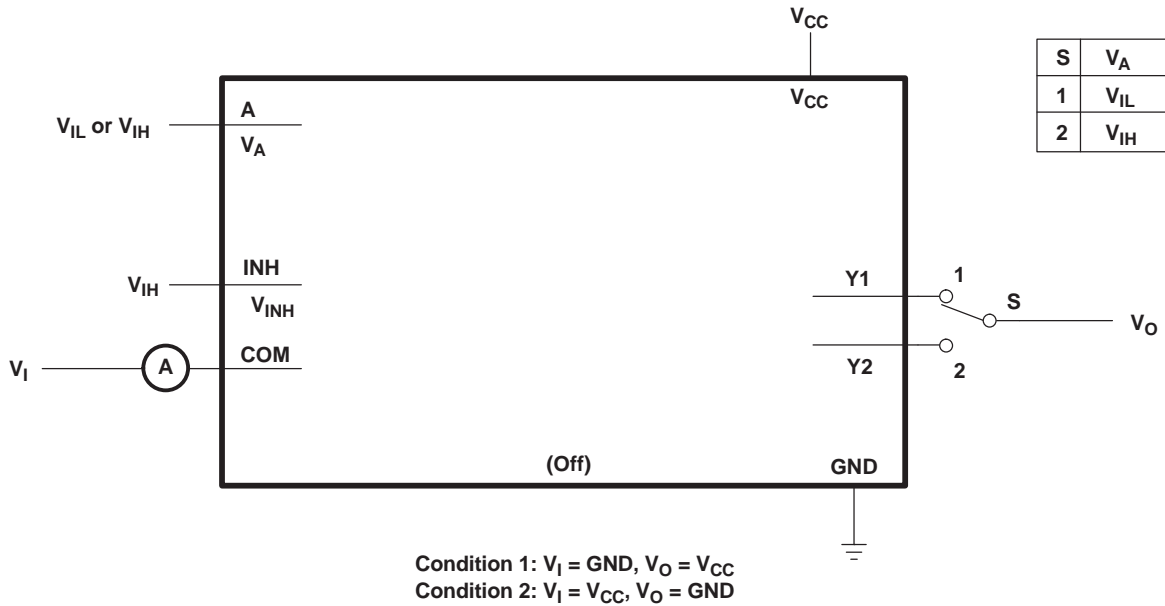

Figure 3. Off-State Switch Leakage-Current Test Circuit

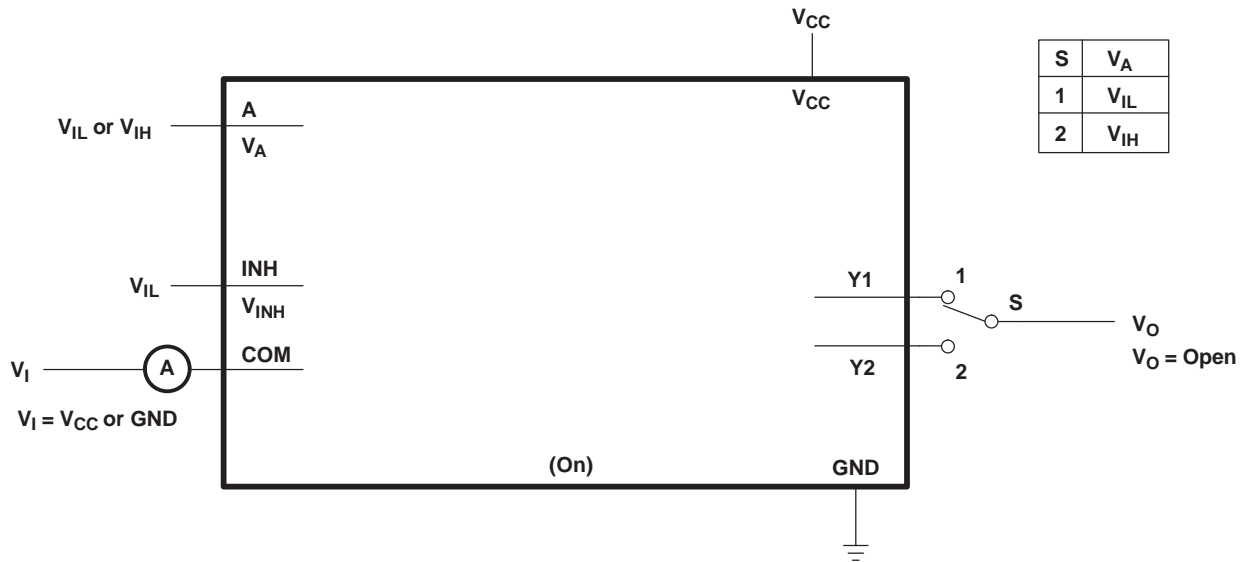
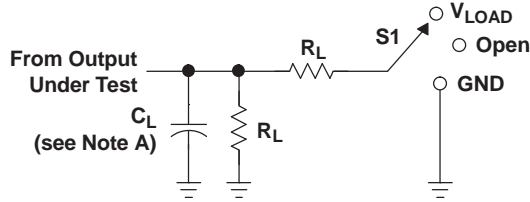

Figure 4. On-State Switch Leakage-Current Test Circuit



PARAMETER MEASUREMENT INFORMATION



TEST	S1
$t_{PLH}/t_{PHL}$	Open
$t_{PLZ}/t_{PZL}$	$V_{LOAD}$
$t_{PHZ}/t_{PZH}$	GND

LOAD CIRCUIT

$V_{CC}$	INPUTS		$V_M$	$V_{LOAD}$	$C_L$	$R_L$	$V_{\Delta}$
	$V_I$	$t_r/t_f$					
0.8 V	$V_{CC}$	$\leq 2$ ns	$V_{CC}/2$	$2 \times V_{CC}$	15 pF	2 k $\Omega$	0.1 V
$1.2 \text{ V} \pm 0.1 \text{ V}$	$V_{CC}$	$\leq 2$ ns	$V_{CC}/2$	$2 \times V_{CC}$	15 pF	2 k $\Omega$	0.1 V
$1.5 \text{ V} \pm 0.1 \text{ V}$	$V_{CC}$	$\leq 2$ ns	$V_{CC}/2$	$2 \times V_{CC}$	15 pF	2 k $\Omega$	0.1 V
$1.8 \text{ V} \pm 0.15 \text{ V}$	$V_{CC}$	$\leq 2$ ns	$V_{CC}/2$	$2 \times V_{CC}$	15 pF	2 k $\Omega$	0.15 V
$2.5 \text{ V} \pm 0.2 \text{ V}$	$V_{CC}$	$\leq 2$ ns	$V_{CC}/2$	$2 \times V_{CC}$	15 pF	2 k $\Omega$	0.15 V
$1.8 \text{ V} \pm 0.15 \text{ V}$	$V_{CC}$	$\leq 2$ ns	$V_{CC}/2$	$2 \times V_{CC}$	30 pF	1 k $\Omega$	0.15 V
$2.5 \text{ V} \pm 0.2 \text{ V}$	$V_{CC}$	$\leq 2$ ns	$V_{CC}/2$	$2 \times V_{CC}$	30 pF	500 $\Omega$	0.15 V

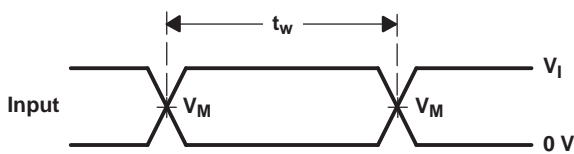

VOLTAGE WAVEFORMS PULSE DURATION

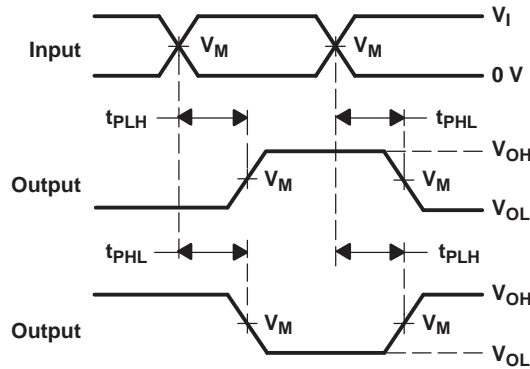

VOLTAGE WAVEFORMS PROPAGATION DELAY TIMES INVERTING AND NONINVERTING OUTPUTS

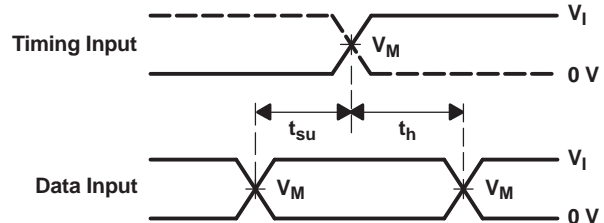

VOLTAGE WAVEFORMS SETUP AND HOLD TIMES

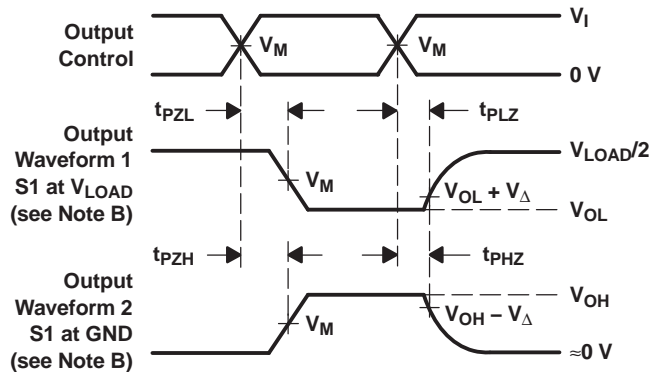

VOLTAGE WAVEFORMS ENABLE AND DISABLE TIMES LOW- AND HIGH-LEVEL ENABLING

- NOTES:
- A.  $C_L$  includes probe and jig capacitance.
  - B. Waveform 1 is for an output with internal conditions such that the output is low, except when disabled by the output control. Waveform 2 is for an output with internal conditions such that the output is high, except when disabled by the output control.
  - C. All input pulses are supplied by generators having the following characteristics: PRR  $\leq$  10 MHz,  $Z_O = 50 \Omega$ , slew rate  $\geq$  1 V/ns.
  - D. The outputs are measured one at a time, with one transition per measurement.
  - E.  $t_{PLZ}$  and  $t_{PHZ}$  are the same as  $t_{dis}$ .
  - F.  $t_{PZL}$  and  $t_{PZH}$  are the same as  $t_{en}$ .
  - G.  $t_{PLH}$  and  $t_{PHL}$  are the same as  $t_{pd}$ .
  - H. All parameters and waveforms are not applicable to all devices.

Figure 5. Load Circuit and Voltage Waveforms

PARAMETER MEASUREMENT INFORMATION

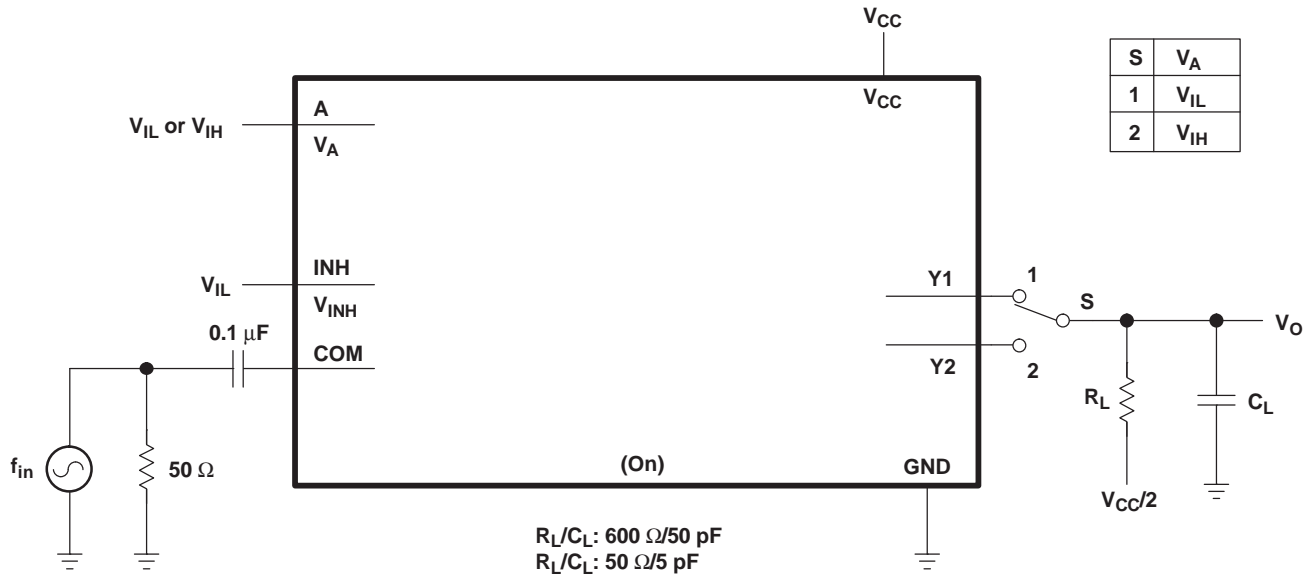

Figure 6. Frequency Response (Switch On)

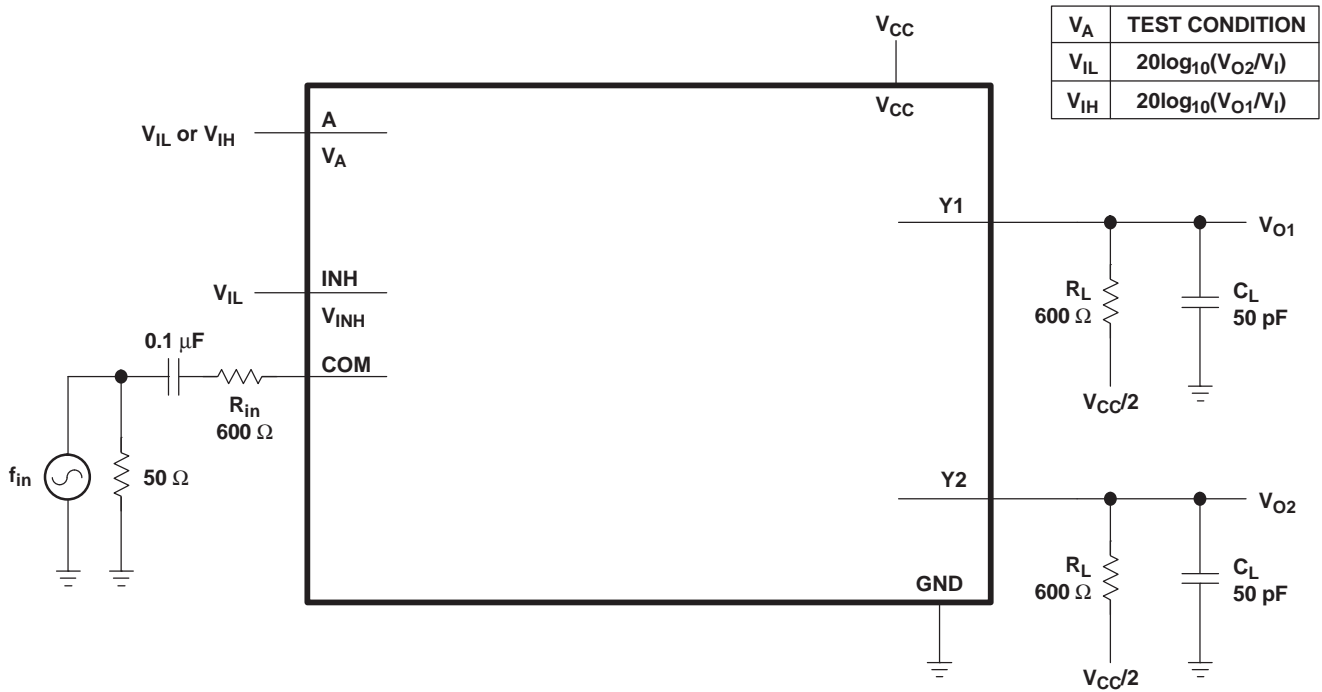

Figure 7. Crosstalk (Between Switches)

PARAMETER MEASUREMENT INFORMATION

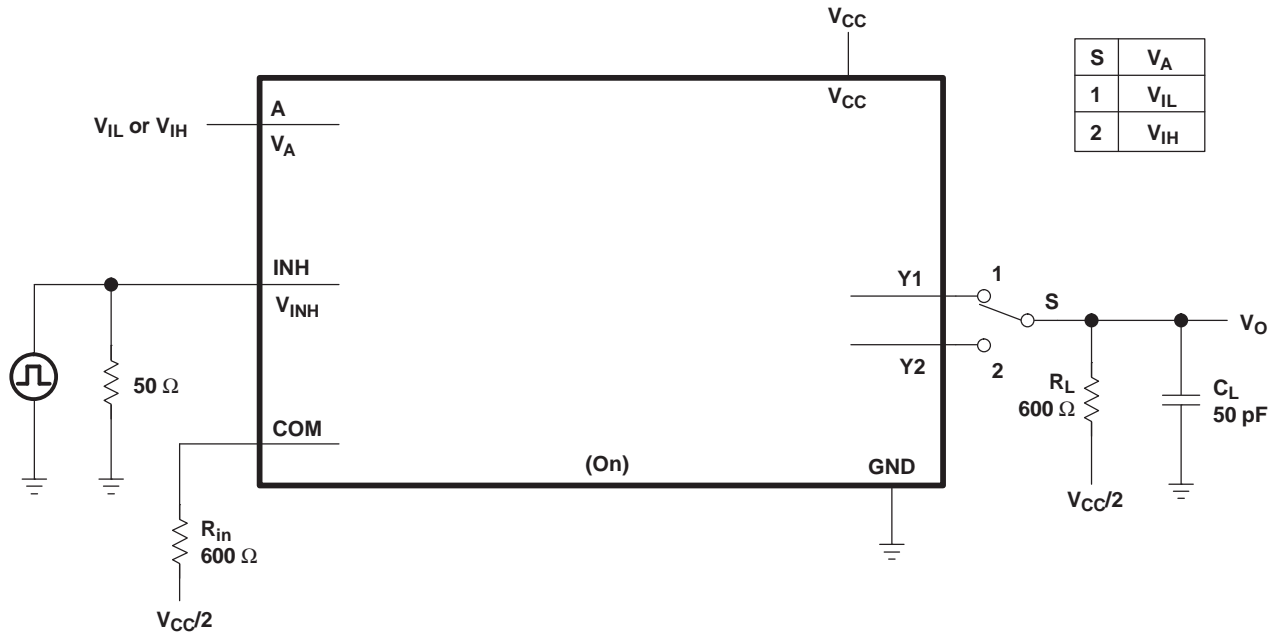

Figure 8. Crosstalk (Control Input, Switch Output)

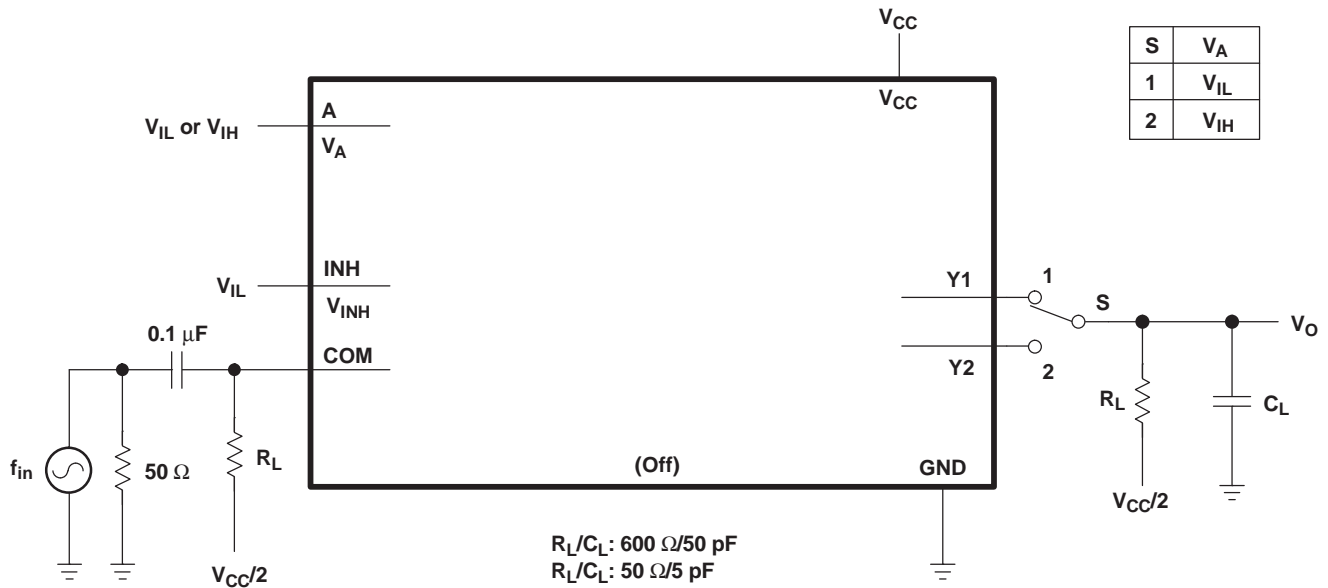

Figure 9. Feedthrough (Switch Off)

PARAMETER MEASUREMENT INFORMATION

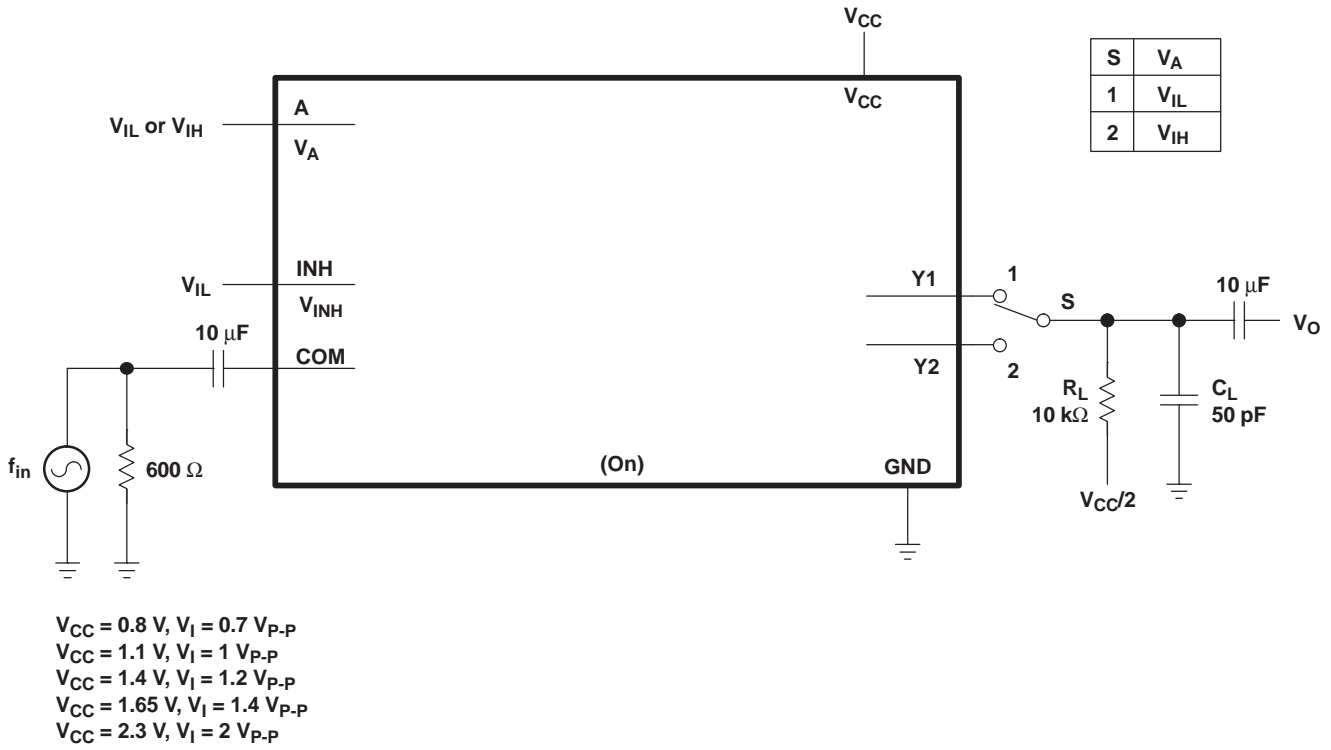

Figure 10. Sine-Wave Distortion

**PACKAGING INFORMATION**

Orderable Device	Status <sup>(1)</sup>	Package Type	Package Drawing	Pins	Package Qty	Eco Plan <sup>(2)</sup>	Lead/Ball Finish	MSL Peak Temp <sup>(3)</sup>
SN74AUC2G53DCTR	ACTIVE	SM8	DCT	8	3000	Green (RoHS & no Sb/Br)	CU NIPDAU	Level-1-260C-UNLIM
SN74AUC2G53DCTRE4	ACTIVE	SM8	DCT	8	3000	Green (RoHS & no Sb/Br)	CU NIPDAU	Level-1-260C-UNLIM
SN74AUC2G53DCTRG4	ACTIVE	SM8	DCT	8	3000	Green (RoHS & no Sb/Br)	CU NIPDAU	Level-1-260C-UNLIM
SN74AUC2G53DCUR	ACTIVE	US8	DCU	8	3000	Green (RoHS & no Sb/Br)	CU NIPDAU	Level-1-260C-UNLIM
SN74AUC2G53DCURE4	ACTIVE	US8	DCU	8	3000	Green (RoHS & no Sb/Br)	CU NIPDAU	Level-1-260C-UNLIM
SN74AUC2G53DCURG4	ACTIVE	US8	DCU	8	3000	Green (RoHS & no Sb/Br)	CU NIPDAU	Level-1-260C-UNLIM
SN74AUC2G53YZPR	ACTIVE	DSBGA	YZP	8	3000	Green (RoHS & no Sb/Br)	SNAGCU	Level-1-260C-UNLIM

<sup>(1)</sup> The marketing status values are defined as follows:

**ACTIVE:** Product device recommended for new designs.

**LIFEBUY:** TI has announced that the device will be discontinued, and a lifetime-buy period is in effect.

**NRND:** Not recommended for new designs. Device is in production to support existing customers, but TI does not recommend using this part in a new design.

**PREVIEW:** Device has been announced but is not in production. Samples may or may not be available.

**OBSELETE:** TI has discontinued the production of the device.

<sup>(2)</sup> Eco Plan - The planned eco-friendly classification: Pb-Free (RoHS), Pb-Free (RoHS Exempt), or Green (RoHS & no Sb/Br) - please check <http://www.ti.com/productcontent> for the latest availability information and additional product content details.

**TBD:** The Pb-Free/Green conversion plan has not been defined.

**Pb-Free (RoHS):** TI's terms "Lead-Free" or "Pb-Free" mean semiconductor products that are compatible with the current RoHS requirements for all 6 substances, including the requirement that lead not exceed 0.1% by weight in homogeneous materials. Where designed to be soldered at high temperatures, TI Pb-Free products are suitable for use in specified lead-free processes.

**Pb-Free (RoHS Exempt):** This component has a RoHS exemption for either 1) lead-based flip-chip solder bumps used between the die and package, or 2) lead-based die adhesive used between the die and leadframe. The component is otherwise considered Pb-Free (RoHS compatible) as defined above.

**Green (RoHS & no Sb/Br):** TI defines "Green" to mean Pb-Free (RoHS compatible), and free of Bromine (Br) and Antimony (Sb) based flame retardants (Br or Sb do not exceed 0.1% by weight in homogeneous material)

<sup>(3)</sup> MSL, Peak Temp. -- The Moisture Sensitivity Level rating according to the JEDEC industry standard classifications, and peak solder temperature.

**Important Information and Disclaimer:**The information provided on this page represents TI's knowledge and belief as of the date that it is provided. TI bases its knowledge and belief on information provided by third parties, and makes no representation or warranty as to the accuracy of such information. Efforts are underway to better integrate information from third parties. TI has taken and continues to take reasonable steps to provide representative and accurate information but may not have conducted destructive testing or chemical analysis on incoming materials and chemicals. TI and TI suppliers consider certain information to be proprietary, and thus CAS numbers and other limited information may not be available for release.

In no event shall TI's liability arising out of such information exceed the total purchase price of the TI part(s) at issue in this document sold by TI to Customer on an annual basis.

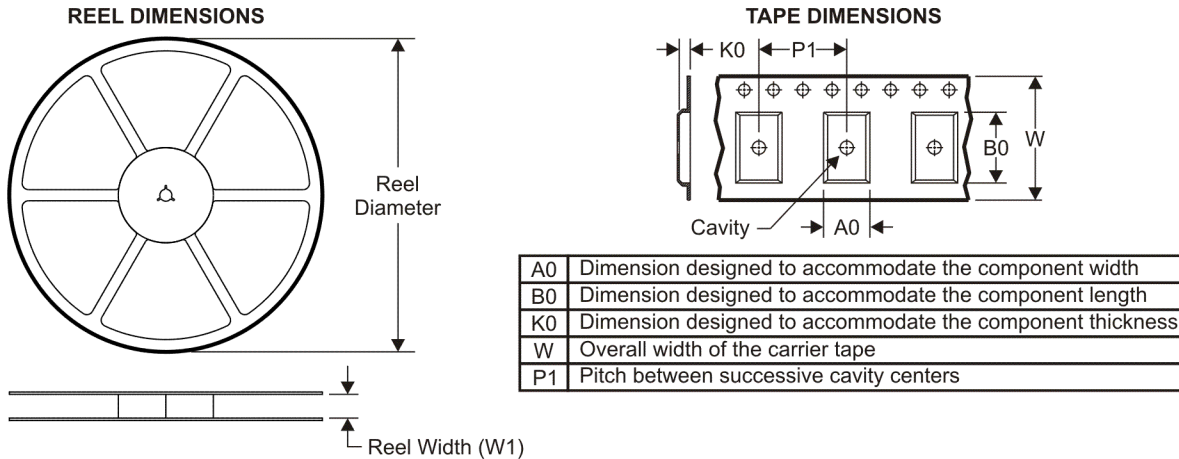
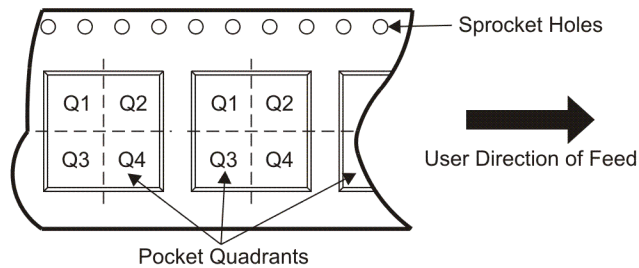
**TAPE AND REEL INFORMATION**

**QUADRANT ASSIGNMENTS FOR PIN 1 ORIENTATION IN TAPE**

\*All dimensions are nominal

Device	Package Type	Package Drawing	Pins	SPQ	Reel Diameter (mm)	Reel Width W1 (mm)	A0 (mm)	B0 (mm)	K0 (mm)	P1 (mm)	W (mm)	Pin1 Quadrant
SN74AUC2G53DCUR	US8	DCU	8	3000	180.0	8.4	2.25	3.35	1.05	4.0	8.0	Q3
SN74AUC2G53YZPR	DSBGA	YZP	8	3000	180.0	8.4	1.02	2.02	0.63	4.0	8.0	Q1

**TAPE AND REEL BOX DIMENSIONS**

\*All dimensions are nominal

Device	Package Type	Package Drawing	Pins	SPQ	Length (mm)	Width (mm)	Height (mm)
SN74AUC2G53DCUR	US8	DCU	8	3000	202.0	201.0	28.0
SN74AUC2G53YZPR	DSBGA	YZP	8	3000	220.0	220.0	34.0







DCU (S-PDSO-G8)

PLASTIC SMALL OUTLINE PACKAGE (DIE DOWN)

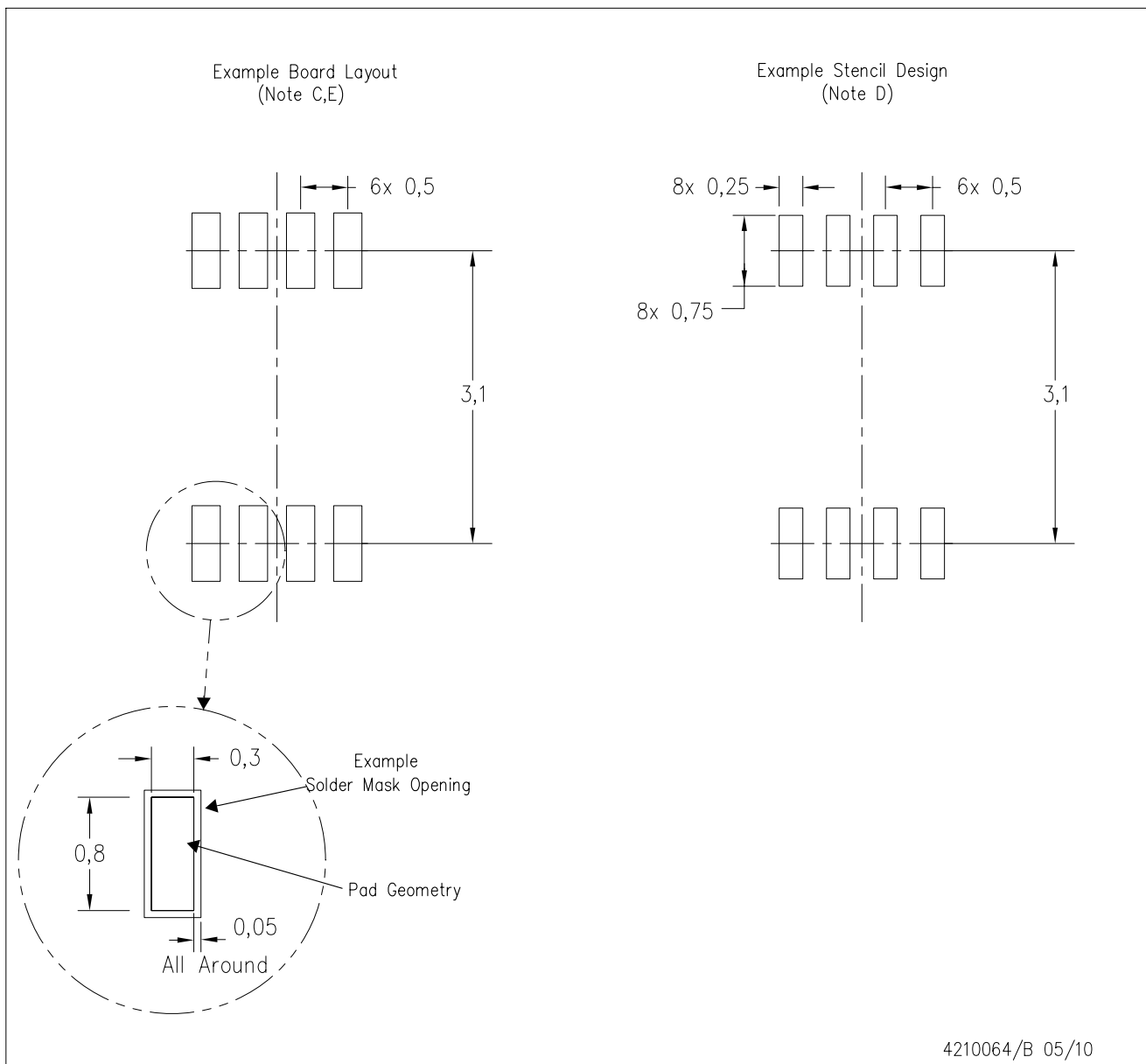

- NOTES:
- All linear dimensions are in millimeters.
  - This drawing is subject to change without notice.
  - Publication IPC-7351 is recommended for alternate designs.
  - Laser cutting apertures with trapezoidal walls and also rounding corners will offer better paste release. Customers should contact their board assembly site for stencil design recommendations. Refer to IPC-7525.
  - Customers should contact their board fabrication site for solder mask tolerances between and around signal pads.

YZP (R-XBGA-N8)

DIE-SIZE BALL GRID ARRAY

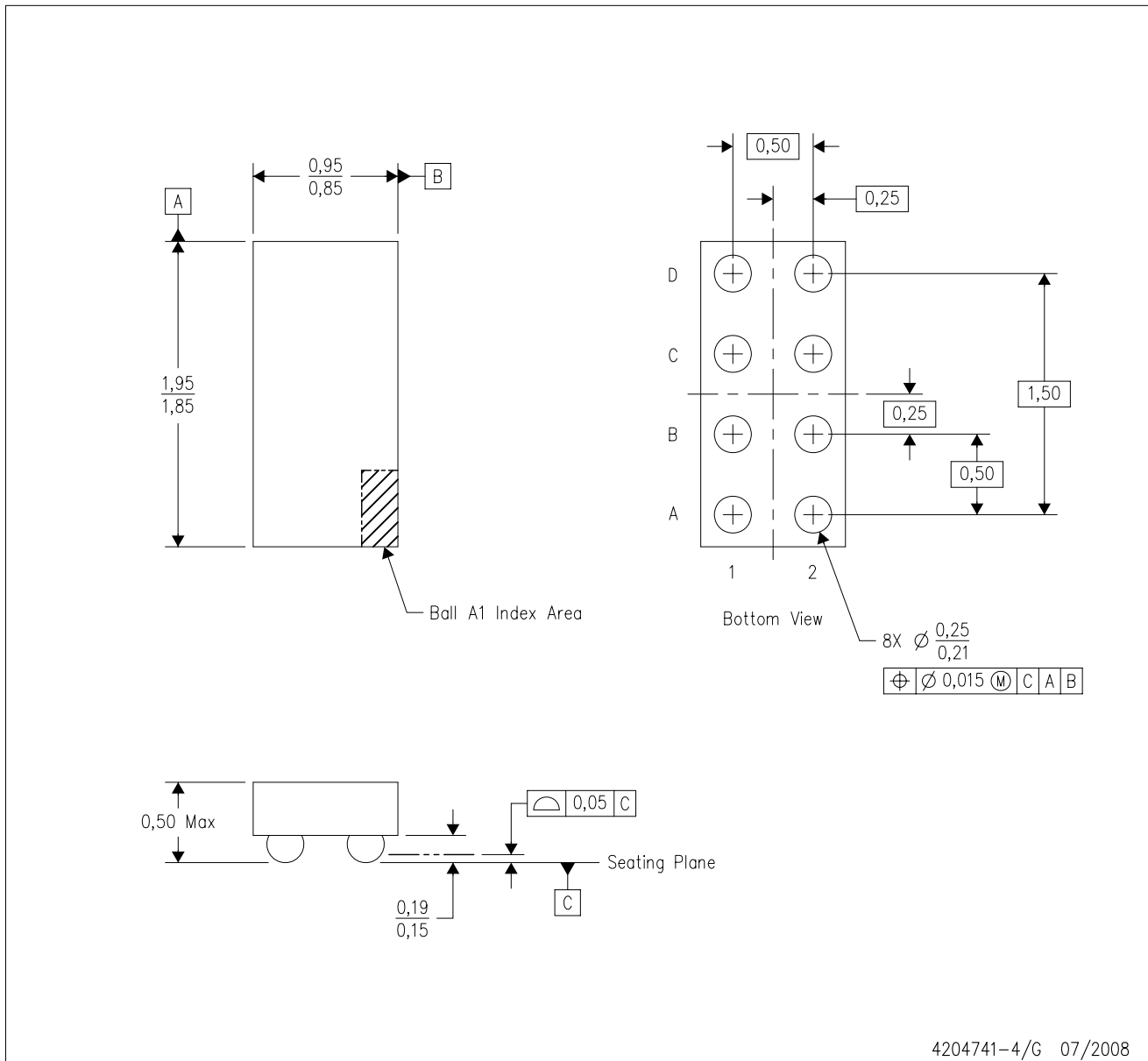

- NOTES:
- A. All linear dimensions are in millimeters. Dimensioning and tolerancing per ASME Y14.5M-1994.
  - B. This drawing is subject to change without notice.
  - C. NanoFree™ package configuration.
  - D. This package is lead-free. Refer to the 8 YEP package (drawing 4204725) for tin-lead (SnPb).

NanoFree is a trademark of Texas Instruments.

## IMPORTANT NOTICE

Texas Instruments Incorporated and its subsidiaries (TI) reserve the right to make corrections, modifications, enhancements, improvements, and other changes to its products and services at any time and to discontinue any product or service without notice. Customers should obtain the latest relevant information before placing orders and should verify that such information is current and complete. All products are sold subject to TI's terms and conditions of sale supplied at the time of order acknowledgment.

TI warrants performance of its hardware products to the specifications applicable at the time of sale in accordance with TI's standard warranty. Testing and other quality control techniques are used to the extent TI deems necessary to support this warranty. Except where mandated by government requirements, testing of all parameters of each product is not necessarily performed.

TI assumes no liability for applications assistance or customer product design. Customers are responsible for their products and applications using TI components. To minimize the risks associated with customer products and applications, customers should provide adequate design and operating safeguards.

TI does not warrant or represent that any license, either express or implied, is granted under any TI patent right, copyright, mask work right, or other TI intellectual property right relating to any combination, machine, or process in which TI products or services are used. Information published by TI regarding third-party products or services does not constitute a license from TI to use such products or services or a warranty or endorsement thereof. Use of such information may require a license from a third party under the patents or other intellectual property of the third party, or a license from TI under the patents or other intellectual property of TI.

Reproduction of TI information in TI data books or data sheets is permissible only if reproduction is without alteration and is accompanied by all associated warranties, conditions, limitations, and notices. Reproduction of this information with alteration is an unfair and deceptive business practice. TI is not responsible or liable for such altered documentation. Information of third parties may be subject to additional restrictions.

Resale of TI products or services with statements different from or beyond the parameters stated by TI for that product or service voids all express and any implied warranties for the associated TI product or service and is an unfair and deceptive business practice. TI is not responsible or liable for any such statements.

TI products are not authorized for use in safety-critical applications (such as life support) where a failure of the TI product would reasonably be expected to cause severe personal injury or death, unless officers of the parties have executed an agreement specifically governing such use. Buyers represent that they have all necessary expertise in the safety and regulatory ramifications of their applications, and acknowledge and agree that they are solely responsible for all legal, regulatory and safety-related requirements concerning their products and any use of TI products in such safety-critical applications, notwithstanding any applications-related information or support that may be provided by TI. Further, Buyers must fully indemnify TI and its representatives against any damages arising out of the use of TI products in such safety-critical applications.

TI products are neither designed nor intended for use in military/aerospace applications or environments unless the TI products are specifically designated by TI as military-grade or "enhanced plastic." Only products designated by TI as military-grade meet military specifications. Buyers acknowledge and agree that any such use of TI products which TI has not designated as military-grade is solely at the Buyer's risk, and that they are solely responsible for compliance with all legal and regulatory requirements in connection with such use.

TI products are neither designed nor intended for use in automotive applications or environments unless the specific TI products are designated by TI as compliant with ISO/TS 16949 requirements. Buyers acknowledge and agree that, if they use any non-designated products in automotive applications, TI will not be responsible for any failure to meet such requirements.

Following are URLs where you can obtain information on other Texas Instruments products and application solutions:

### Products

Audio	<a href="http://www.ti.com/audio">www.ti.com/audio</a>
Amplifiers	<a href="http://amplifier.ti.com">amplifier.ti.com</a>
Data Converters	<a href="http://dataconverter.ti.com">dataconverter.ti.com</a>
DLP® Products	<a href="http://www.dlp.com">www.dlp.com</a>
DSP	<a href="http://dsp.ti.com">dsp.ti.com</a>
Clocks and Timers	<a href="http://www.ti.com/clocks">www.ti.com/clocks</a>
Interface	<a href="http://interface.ti.com">interface.ti.com</a>
Logic	<a href="http://logic.ti.com">logic.ti.com</a>
Power Mgmt	<a href="http://power.ti.com">power.ti.com</a>
Microcontrollers	<a href="http://microcontroller.ti.com">microcontroller.ti.com</a>
RFID	<a href="http://www.ti-rfid.com">www.ti-rfid.com</a>
RF/IF and ZigBee® Solutions	<a href="http://www.ti.com/lprf">www.ti.com/lprf</a>

### Applications

Communications and Telecom	<a href="http://www.ti.com/communications">www.ti.com/communications</a>
Computers and Peripherals	<a href="http://www.ti.com/computers">www.ti.com/computers</a>
Consumer Electronics	<a href="http://www.ti.com/consumer-apps">www.ti.com/consumer-apps</a>
Energy and Lighting	<a href="http://www.ti.com/energy">www.ti.com/energy</a>
Industrial	<a href="http://www.ti.com/industrial">www.ti.com/industrial</a>
Medical	<a href="http://www.ti.com/medical">www.ti.com/medical</a>
Security	<a href="http://www.ti.com/security">www.ti.com/security</a>
Space, Avionics and Defense	<a href="http://www.ti.com/space-avionics-defense">www.ti.com/space-avionics-defense</a>
Transportation and Automotive	<a href="http://www.ti.com/automotive">www.ti.com/automotive</a>
Video and Imaging	<a href="http://www.ti.com/video">www.ti.com/video</a>
Wireless	<a href="http://www.ti.com/wireless-apps">www.ti.com/wireless-apps</a>

TI E2E Community Home Page

[e2e.ti.com](http://e2e.ti.com)

Mailing Address: Texas Instruments, Post Office Box 655303, Dallas, Texas 75265  
Copyright © 2011, Texas Instruments Incorporated