

# Low Profile

PHJ-8P8C-1-6-5  
(shown)

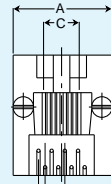
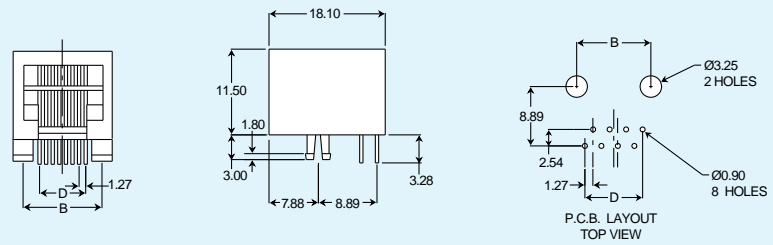
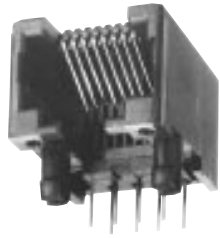

NO. OF POSITIONS	DIMENSIONS			
	A	B	C	D
4	11.18	7.62	3.05	3.81
6	13.21	10.16	5.08	6.35
8	15.24	11.43	7.11	8.89

PHJ-8P8C-1-I-5  
(shown)

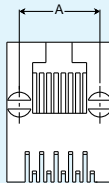
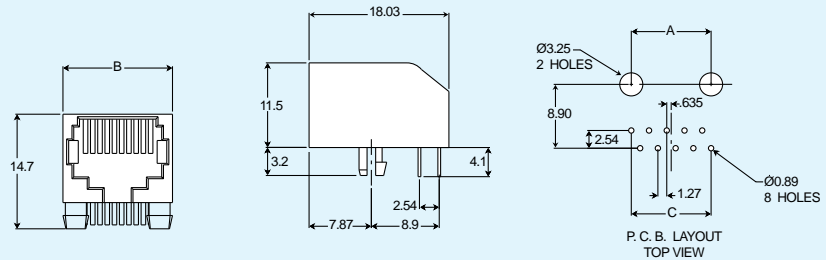
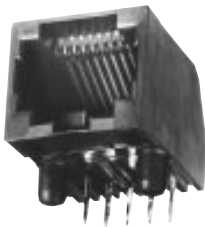

NO. OF POSITIONS	DIMENSIONS		
	A	B	C
6	10.16	13.24	6.35
8	11.43	15.24	8.89
10	11.43	15.24	11.43

PHJ-10P10C-1S-I-5  
(shown)  
Shielded

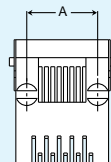
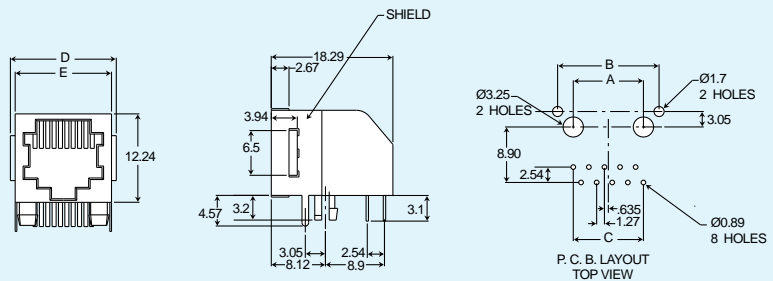
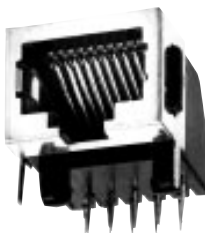

NO. OF POSITIONS	DIMENSIONS				
	A	B	C	D	E
6	10.26	13.46	6.35	15.75	14.10
8	11.43	15.50	8.89	17.78	16.10
10	11.43	15.50	11.43	17.78	16.10

Specifications subject to change without notice. Dimensions in mm.



# Low Profile



PHJ-8P8C-1-J-5  
(shown)

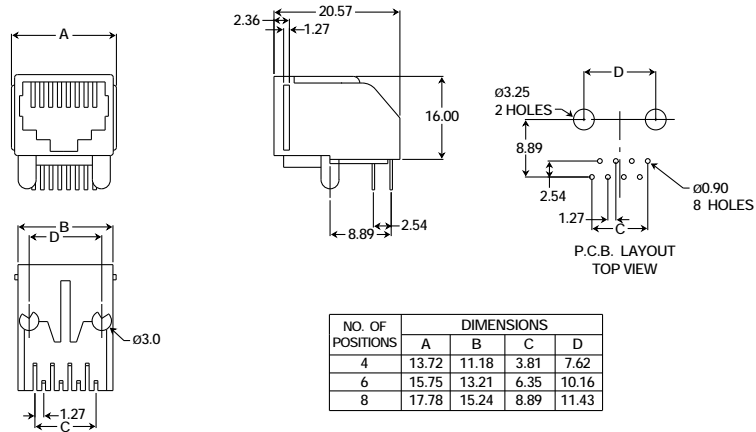
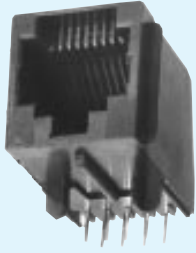

PHJ-8P8C-1-K-5  
(shown)

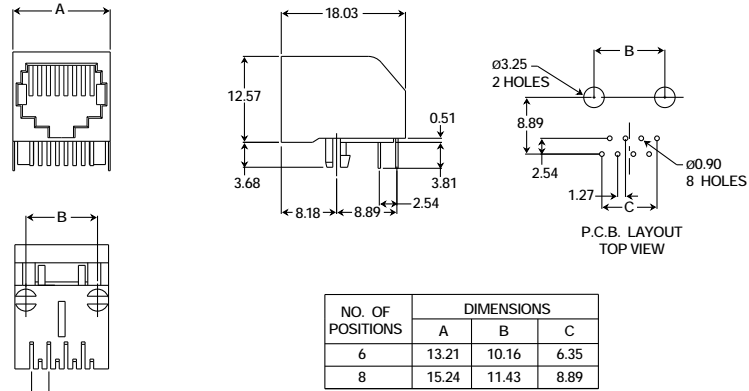
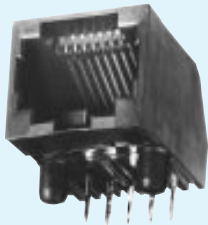

PHJ-8P8C-1S-K-5  
(shown)  
Shielded

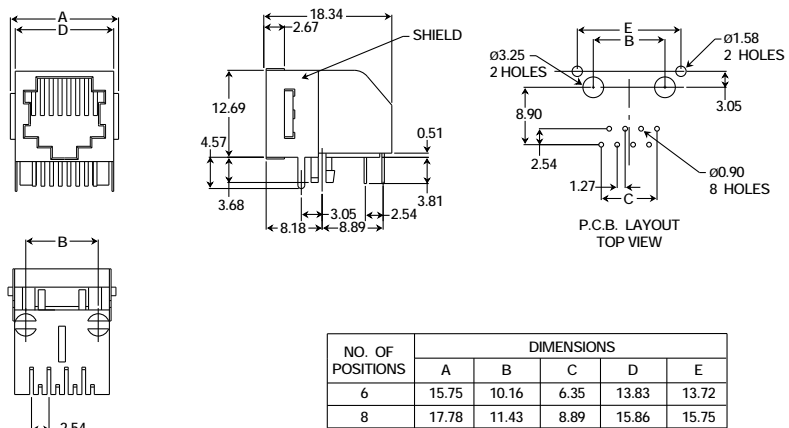
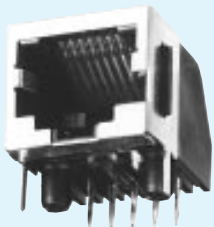

Specifications subject to change without notice. Dimensions in mm.

# Low Profile

PHJ-8P8C-1-U-5

(shown)  
Surface Mount

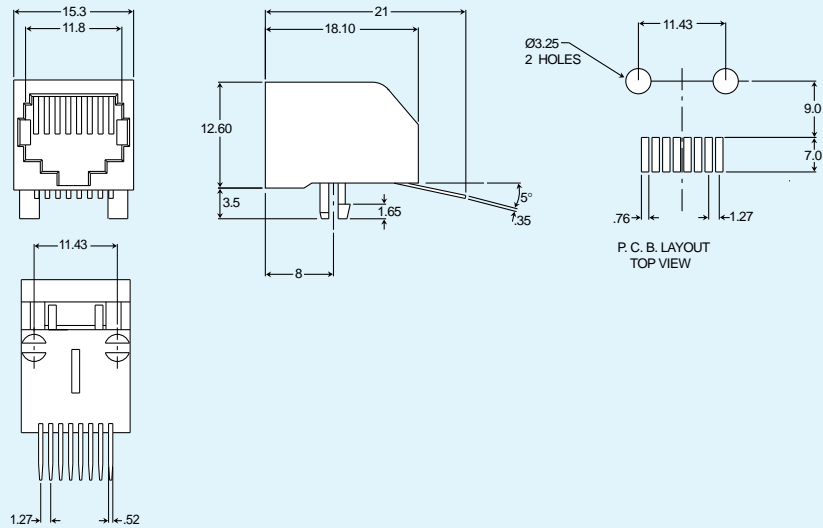
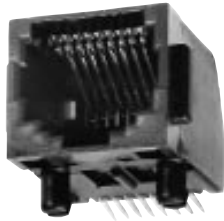

Shielded version also available.

PHJ-8P8C-1-L-5

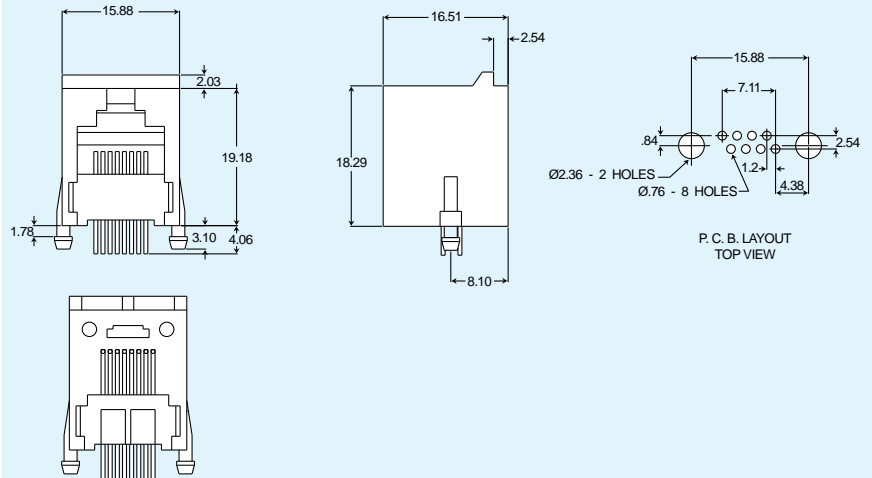

PHJ-6P6C-1-H-5

(shown)

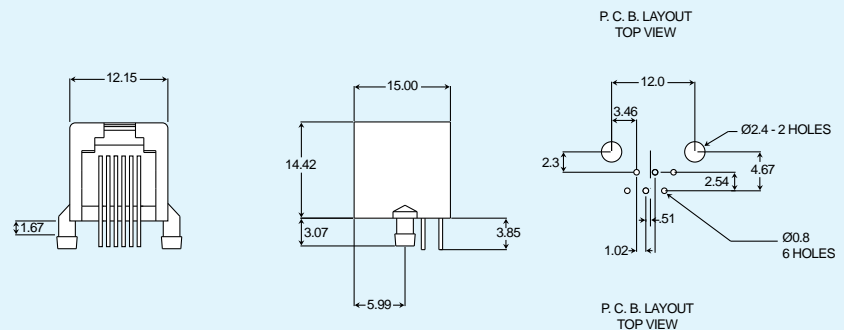

Also available in 4P4C.

Specifications subject to change without notice. Dimensions in mm.

