

**NEW!**

Coupled Inductors - LPR6235

For Step-Up, Resonant & Flyback Applications

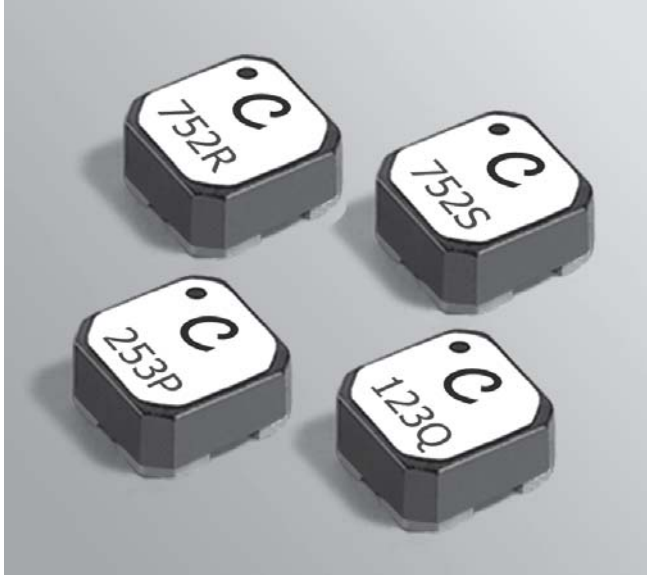

- Can be used as step-up or flyback transformers in DC-DC converters or as autotransformers
- Perfect for low voltage step-up in energy harvesting applications

These shielded parts are only 3.5 mm high and 6 mm square. The excellent coupling coefficient ($k = 0.95$) makes them ideal for use in a variety of applications, such as flyback converters and step-up pulse transformer applications.

The high I_{sat} and low DCR ratings of these low profile parts provide high efficiency and excellent current handling in a rugged, low cost design.

Custom inductance values and turn ratios may be available upon request.

Part number ¹	Turns ratio	Primary (L1) inductance ² ± 20% (μH)	DCR max (Ohms)		SRF typ ³ (MHz)	Isat ⁴ (A)
			L1	L2		
LPR6235-253PML_	1:20	25	0.20	58	580	0.7
LPR6235-123QML_	1:50	12.5	0.080	200	382	0.9
LPR6235-752RML_	1:90	7.5	0.085	267	257	1.6
LPR6235-752SML_	1:100	7.5	0.085	305	244	1.6

1. When ordering, please specify **packaging** code:

LPR6235-253PML **C**

Packaging: **C** = 7" machine-ready reel. EIA-481 embossed plastic tape (350 parts per full reel).

B = Less than full reel. In tape, but not machine ready. To have a leader and trailer added (\$25 charge), use code letter D instead.

D = 13" machine-ready reel. EIA-481 embossed plastic tape. Factory order only, not stocked (1500 parts per full reel).

2. Inductance is measured at 100 kHz, 0.1 V_{rms}, 0 A_{dc} on an Agilent/HP 4284A LCR meter or equivalent.

3. SRF measured using an Agilent/HP 4191A or equivalent.

4. DC current applied to L1, at which the inductance drops 10% from its value without current.

5. Electrical specifications at 25°C.

Refer to Doc 362 "Soldering Surface Mount Components" before soldering.

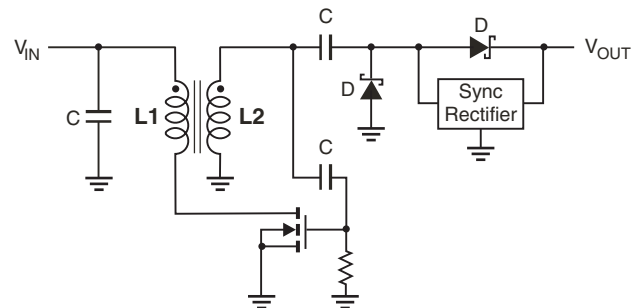

Typical Step-Up Converter

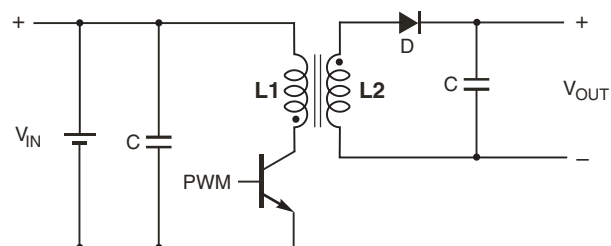

Typical Flyback Converter

Coilcraft®

Specifications subject to change without notice.
Please check our website for latest information.

Document 752-1 Revised 04/14/10

1102 Silver Lake Road Cary, Illinois 60013 Phone 847/639-6400 Fax 847/639-1469

E-mail info@coilcraft.com Web <http://www.coilcraft.com>

**NEW!**

Step-Up/Flyback Transformers – LPR6235

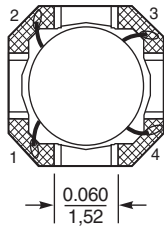
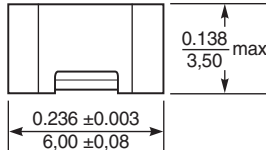
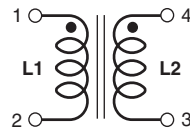
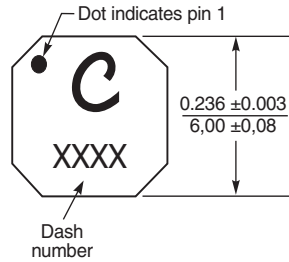

Dimensions are in $\frac{\text{inches}}{\text{mm}}$

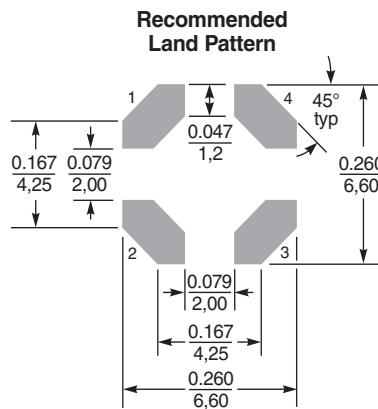

Core material Ferrite

Weight 460 – 480 mg

Terminations RoHS compliant silver-palladium-platinum-glass frit. Other terminations available at additional cost.

Ambient temperature –40°C to +85°C with I rms current, +85°C to +125°C with derated current

Storage temperature Component: –40°C to +125°C. Packaging: –40°C to +80°C

Winding to winding isolation 100 V

Resistance to soldering heat Max three 40 second reflows at +260°C, parts cooled to room temperature between cycles

Moisture Sensitivity Level (MSL) 1 (unlimited floor life at <30°C / 85% relative humidity)

Mean Time Between Failures (MTBF) 26,315,789 hours

Failures in Time (FIT) 38 per one billion hours

Packaging 350/7" reel; 1500/13" reel Plastic tape: 12 mm wide, 0.3 mm thick, 8 mm pocket spacing, 3.68 mm pocket depth

Recommended pick and place nozzle OD: 6.2 mm; ID: ≤ 3.1 mm

PCB washing Only pure water or alcohol recommended

Coilcraft®

Specifications subject to change without notice.
Please check our website for latest information.

Document 752-2 Revised 04/14/10

1102 Silver Lake Road Cary, Illinois 60013 Phone 847/639-6400 Fax 847/639-1469

E-mail info@coilcraft.com Web <http://www.coilcraft.com>