



Resistor Product Discontinuation & Update

We would like to take this opportunity to thank you for your patronage and the many years of support you have given to our resistive products. As you know we are de-emphasizing the product line and would like to inform you of our decision to re-align our product offering.

AVX will expand our focus on our 0408 and smaller resistor array products and discontinue to offer our larger case size resistor chip series along with the 1206 resistor arrays. This will be accomplished in several stages over the next twelve months. Please refer to each product series below and the effective dates we will cease to supply the products.

- **Chip Resistor Series (CR63, CR32, CR21, CR10)**
Final Ship Date: February 1st, 2004
- **Chip Resistor Series (CR05)**
Final Ship Date: August 1st, 2004
- **1206 Resistor Array Series (CRA3A4E, CRB3A4E, CRC3A4E)**
Final Ship Date: August 1st, 2004

We would like to work closely with you during the discontinuation period and minimize any inconveniences that may arise. Should you have any questions or comments, please contact KDP Marketing.

Thick Film Chip Resistors



CR, CJ Series



STRUCTURE AND MATERIAL

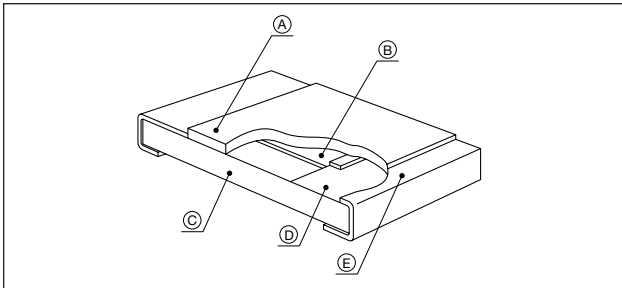

Code	Structure	Material
A	Coating	Glass or Epoxy
B	Resistor	RuO ₂ Resistor (The same material of Termination for chip jumper)
C	Substrate	96% Alumina
D	Termination	Silver
E	Plating	(Ni, Sn-Pb) Plating

FEATURES

- Low Noise
- Nickel Barrier Terminations

APPLICATION

- General Purpose

HOW TO ORDER

CR 05 - 472 J - H

Packaging

- T = 7" Reel/Punched Paper Tape (5,000 pcs/reel) except CR05
- H = 7" Reel/Punched Paper Tape (10,000 pcs/reel, 2mm pitch taping) CR03 and CR05
- D = 10" Reel/Punched Paper Tape (10,000 pcs/reel) CR32, CR21, CR10

Resistance Tolerance

- D = ±0.5% J = ±5%
- F = ±1% Blank = Chip Jumper

Resistance Value (3 digits or 4 digits)

Example: 2 significant figures and 1 multiplier
R indicator decimal or values <10Ω
Chip Jumper = 000

Size (EIA)

- 03 = 0201 21 = 0805
- 05 = 0402 32 = 1206
- 10 = 0603

Series

- CR = Resistor
- CJ = Jumper

DIMENSIONS

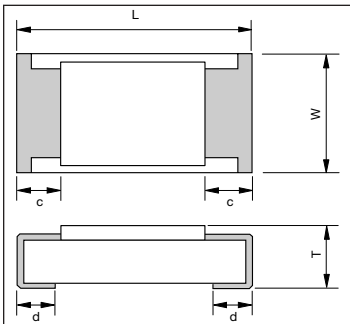

	CR03, CJ03 (0201)	CR05, CJ05 (0402)	CR10, CJ10 (0603)	CR21, CJ21 (0805)	CR32, CJ32 (1206)
W	0.30±0.03 (0.012±0.001)	0.50±0.05 (0.020±0.002)	0.80 ^{+0.15} _{-0.10} (0.031 ^{+0.008} _{-0.008})	1.25 ^{+0.15} _{-0.10} (0.050 ^{+0.008} _{-0.008})	1.55 ^{+0.15} _{-0.10} (0.061 ^{+0.008} _{-0.008})
L	0.60±0.03 (0.024±0.001)	1.00±0.05 (0.039±0.002)	1.60±0.10 (0.063±0.004)	2.00±0.10 (0.080±0.004)	3.10±0.10 (0.122±0.004)
C	0.15±0.10 (0.006±0.004)	0.20±0.15 (0.008±0.006)	0.25±0.20 (0.010±0.008)	0.35±0.20 (0.014±0.008)	0.45±0.20 (0.018±0.008)
d	0.15±0.05 (0.006±0.002)	0.20±0.10 (0.008±0.004)	0.20 ^{+0.20} _{-0.15} (0.008 ^{+0.008} _{-0.008})	0.40±0.20 (0.016±0.008)	0.45±0.20 (0.018±0.008)
T	0.23±0.05 (0.009±0.002)	0.35±0.05 (0.014±0.002)	0.50±0.10 (0.020±0.004)	0.55±0.10 (0.022±0.004)	0.55 ^{+0.10} _{-0.05} (0.022 ^{+0.004} _{-0.002})

SPECIFICATIONS

Series	CR03 (0201)	CR05 (0402)	CR10 (0603)	CR21 (0805)	CR32 (1206)
Rated Power	0.050 (1/20) W	0.0625 (1/16) W	0.10 (1/10) W	0.125 (1/8) W	0.25 (1/4) W
Max. Working Voltage	15V	50V	50V	100V	200V
Resistance Tolerance	J = ±5%	F = ±1% J = ±5%	D = ±0.5% F = ±1% J = ±5%	D = ±0.5% F = ±1% J = ±5%	D = ±0.5% F = ±1% J = ±5%
Resistance Value Range	10Ω to 1MΩ	10Ω to 1MΩ : F 1.0Ω to 10MΩ : J	10Ω to 1MΩ : D 10Ω to 1MΩ : F 1.0Ω to 10MΩ : J	10Ω to 1MΩ : D 10Ω to 1MΩ : F 1.0Ω to 10MΩ : J	10Ω to 1MΩ : D 10Ω to 1MΩ : F 1.0Ω to 10MΩ : J
Working Temperature	-55 to +125°C	-55 to +125°C	-55 to +125°C	-55 to +125°C	-55 to +125°C

Thick Film Chip Resistors



CR, CJ Series

SPECIFICATIONS

CJ Series

Part Number	CJ03	CJ05, CJ10, CJ21 (0402, 0603, 0805 Type)	CJ32 (1206 Type)
Rated Current	0.5A (70°C)	1A (70°C)	2A (70°C)
Resistivity	50mΩ max.	50mΩ max.	50mΩ max.
Working Temperature	-55 to +125°C	-55 to +125°C	-55 to +125°C

HOW TO CALCULATE RATED VOLTAGE

$$E = \sqrt{P \cdot R}$$

E = Rated Voltage (V)

P = Rated Power (W)

R = Standard Resistance Value (Ω)

Rated voltage should be lower than max. working voltage.

RECOMMENDED LAND PATTERN

millimeters (inches)

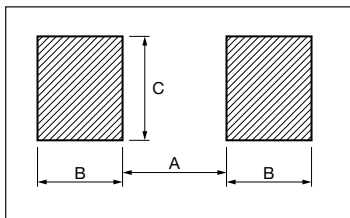

EIA Size	0201	0402	0603	0805	1206
A	0.25 (0.010)	0.50 (0.020)	0.80 (0.031)	1.00 (0.039)	2.00 (0.079)
B	0.225 (0.009)	0.40 (0.016)	0.70 (0.028)	0.80 (0.031)	0.80 (0.031)
C	0.30 (0.012)	0.50 (0.020)	0.80 (0.031)	1.20 (0.047)	1.50 (0.059)

MARKING

Marking available as follows:

Series: CR32, CJ32, CR21, CJ21, CR10, CJ10

3 digit indication

Example: 473=47x10³ = 47000 Ω = 47 kΩ

0 = 0 Ω (Jumper)

100 = 10 Ω

102 = 1 kΩ

105 = 1 MΩ

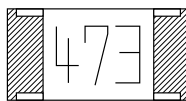

Series: CR03, CJ03, CR05 and CJ05 - No marking

Note: On CR32 4 digit marking is standard for ±1% and ±0.5% tolerances.

STANDARD RESISTANCE VALUE

E24	1.0	1.1	1.2	1.3	1.5	1.6	1.8	2.0	2.2
	2.4	2.7	3.0	3.3	3.6	3.9	4.3	4.7	5.1
	5.6	6.2	6.8	7.5	8.2	9.1			

For ±1% and ±.5% Tolerance

E96	10.0	10.2	10.5	10.7	11.0	11.3	11.5	11.8	12.1	12.4
	12.7	13.0	13.3	13.7	14.0	14.3	14.7	15.0	15.4	15.8
	16.2	16.5	16.9	17.4	17.8	18.2	18.7	19.1	19.6	20.0
	20.5	21.0	21.5	22.1	22.6	23.2	23.7	24.3	24.9	25.5
	26.1	26.7	27.4	28.0	28.7	29.4	30.1	30.9	31.6	32.4
	33.2	34.0	34.8	35.7	36.5	37.4	38.3	39.2	40.2	41.2
	42.2	43.2	44.2	45.3	46.4	47.5	48.7	49.9	51.1	52.3
	53.6	54.9	56.2	57.6	59.0	60.4	61.9	63.4	64.9	66.5
	68.1	69.8	71.5	73.2	75.0	76.8	78.7	80.6	82.5	84.5
	86.6	88.7	90.9	93.1	95.3	97.6				

DERATING CURVE

Rated power should be reduced as below when temperature become higher.

Under high temperature, power derated as follows:

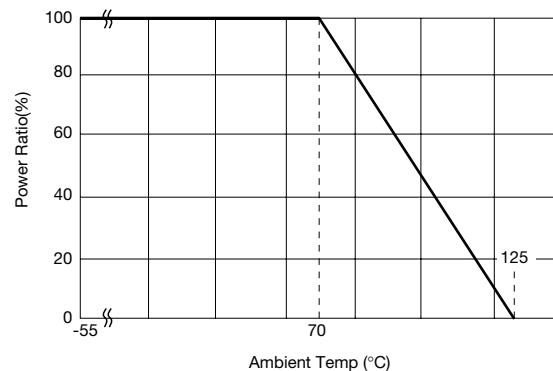

TEMPERATURE CHARACTERISTICS

Resistance (Ω)	TCR (ppm/°C)
D, F 10 ≤ R ≤ 1M	-100 to +100
J R < 10 10 ≤ R ≤ 1M 1M < R	-100 to +600 -200 to +200 -500 to +300

Chip Resistor Arrays



CR, CJ, CRA, CRB, CRC Series - Test Conditions

ELECTRICAL CHARACTERISTICS

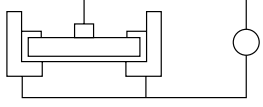
Item	Standard		Test Conditions												
	Resistor	Jumper	Resistor	Jumper											
DC Resistance	Within Initial Tolerance		Power Condition A (20°C, 65% RH)												
Temperature Characteristics	<table border="1"> <thead> <tr> <th>Resistance (Ω)</th> <th>TCR (ppm/°C)</th> </tr> </thead> <tbody> <tr> <td>[*]D, F 10 ≤ R ≤ 1M</td> <td>-100 to +100</td> </tr> <tr> <td>J, CR05 = F R < 10</td> <td>-100 to +600</td> </tr> <tr> <td>10 ≤ R ≤ 1M</td> <td>-250 to +250</td> </tr> <tr> <td>1M < R</td> <td>-500 to +300</td> </tr> </tbody> </table>		Resistance (Ω)	TCR (ppm/°C)	[*] D, F 10 ≤ R ≤ 1M	-100 to +100	J, CR05 = F R < 10	-100 to +600	10 ≤ R ≤ 1M	-250 to +250	1M < R	-500 to +300	/	Test Temperature: 25, 125(°C) $\Delta R/R = R_2 - R_1 / R_1 \times 1 / T_2 - T_1 \times 10^6$ $\Delta R/R = \text{Temp. Coefficient}$ (ppm/°C) T ₁ = 25(°C) T ₂ = 125(°C) R ₁ = T ₁ Resistance at (Ω) R ₂ = T ₂ Resistance at (Ω)	/
	Resistance (Ω)	TCR (ppm/°C)													
[*] D, F 10 ≤ R ≤ 1M	-100 to +100														
J, CR05 = F R < 10	-100 to +600														
10 ≤ R ≤ 1M	-250 to +250														
1M < R	-500 to +300														
Short-time Overload	$\Delta R/R$	50m Ω max.	(1) Apply 2.0 x rated voltage for 5 sec. (2.5 x rated voltage for Arrays) (2) Wait 30 minutes (3) Measure resistance CR03 = 30V max. CR05 = 50V max. CR10 = 100V max. CR21 = 200V max. CR32 = 400V max. CRA3A, CRB3A, CRC3A = 100V max.	(1) 2A for 5 sec. (CJ03 = 1A) (2) Wait 30 minutes (3) Measure resistance											
	Visual	No evidence of mechanical damage intermittent overload													
Intermittent Overload	$\Delta R/R$	50m Ω max.	(1) Perform 10,000 voltage cycles as follows: ON (2.0 x rated voltage, 2.5 x for Arrays) 1 sec. OFF 25 sec. (2) Stabilization time 30 min. without loading (3) Measure resistance CR03 = 30V max. CR05 = 50V max. CR10 = 150V max. CR21 = 200V max. CR32 = 400V max. CRA, CRB, CRC = 100V max.	(1) Perform 10,000 current cycles as follows: ON (2A) 1 sec. OFF 25 sec. (2) Wait 30 minutes (3) Measure resistance CJ03 = 1A max.											
	Visual	No evidence of mechanical damage													
Dielectric Withstanding Voltage	No evidence of mechanical damage		Apply 500 VAC for 1 min. (CR10 300 VAC) (CR05, CRA3A, CRB3A, CRC3A 300 VAC/1 sec. CR03 50 VAC/min.)												
Insulation Resistance	<ul style="list-style-type: none"> • CR03, CJ03 = 10⁸Ω min. • CR05, CJ05 = 10⁸Ω min. • CR10, CJ10 = 10⁹Ω min. • CR21, CJ21 = 10¹⁰Ω min. • CR32, CJ32 = 10¹²Ω min. • CRA3A, CRB3A, CRC3A = 10⁹Ω min. 		Apply 500V DC (CR05, CRA3A, CRB3A, CRC3A 100V DC CR03 50 VDC) 												

Chip Resistor Arrays



CR, CJ, CRA, CRB, CRC Series - Test Conditions

MECHANICAL CHARACTERISTICS

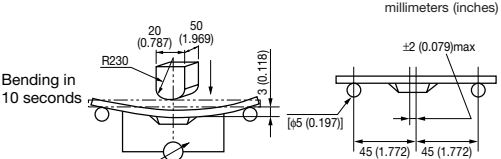
Item		Standard		Test Conditions	
		Resistor	Jumper	Resistor	Jumper
Terminal Strength	$\Delta R/R$	$\pm(1\%+0.05\Omega)$ max. of the initial value	50m Ω max.	Apply the load as shown: Measure resistance during load application 	
	Visual	No evidence of mechanical damage after loading			
Soldering Heat Resistance	$\Delta R/R$	$\pm(1\%+0.05\Omega)$ max. of the initial value	50m Ω max.	Immerse into molten solder at 260 \pm 5 $^{\circ}$ C for 10 \pm 1 sec. Stabilize component at room temperature for 1 hr. Measure resistance.	
	Visual	No evidence of leaching			
Solderability		Coverage \geq 95% each termination end		Immerse in Rogin Flux for 2 \pm 0.5 sec. and in SN62 solder at 235 \pm 5 $^{\circ}$ C for 2 \pm 0.5 sec.	
Anti-Vibration Test	$\Delta R/R$	$\pm(1\%+0.1\Omega)$ max. of the initial value	50m Ω max.	2 hrs. each in X, Y and Z axis. (TTL 6 hrs.) 10 to 55 Hz sweep in 1 min. at 1.5mm amplitude.	
	Visual	No evidence of mechanical damage			
Solvent Resistance	$\Delta R/R$	$\pm(0.5\%+0.05\Omega)$ max. of the initial value	50m Ω max.	Immerse in static state butyl acetate at 20 $^{\circ}$ C to 25 $^{\circ}$ C for 30 \pm 5 sec. Stabilize component at room temperature for 30 min. then measure value.	
	Visual	No evidence of mechanical damage			

ENVIRONMENTAL CHARACTERISTICS

Item		Standard		Test Conditions	
		Resistor	Jumper	Resistor	Jumper
Temperature Cycle	$\Delta R/R$	$\pm(1\%+0.05\Omega)$ max. of the initial value	50m Ω max.	(1) Run 5 cycles as follows: -55 \pm 3 $^{\circ}$ C for 30 min. 125 \pm 3 $^{\circ}$ C for 30 min. Room temp. for 10-15 min. (2) Stabilize component at room temperature for 1 hr. then measure value.	
	Visual	No evidence of mechanical damage			
Low Temperature Storage	$\Delta R/R$	$\pm(2\%+0.1\Omega)$ max. of the initial value	50m Ω max.	(1) Dwell in -55 $^{\circ}$ C chamber without loading for 1000 $^{+48}$ hrs. (2) Stabilize component at room temperature for 1 hr. then measure value.	
	Visual	No evidence of mechanical damage			
High Temperature Storage	$\Delta R/R$	$\pm(3\%+0.1\Omega)$ max. of the initial value	50m Ω max.	(1) Dwell in 125 $^{\circ}$ C chamber without loading for 1000 $^{+48}$ hrs. (2) Stabilize component at room temperature for 1 hr. then measure value.	
	Visual	No evidence of mechanical damage			
Moisture Resistance	$\Delta R/R$	$\pm(3\%+0.1\Omega)$ max. of the initial value	50m Ω max.	(1) Dwell in temp.: 65 $^{\circ}$ C RH90 to 95% RH chamber without loading for 1000 $^{+48}$ hrs. (2) Stabilize component at room temperature for 1 hr. then measure value.	
	Visual	No evidence of mechanical damage			
Life Test	$\Delta R/R$	$\pm(3\%+0.1\Omega)$ max. of the initial value	50m Ω max.	(1) Temp.: 70 \pm 3 $^{\circ}$ C Voltage: (rated voltage) on 90 min. off 30 min. Duration: 1000 $^{+48}$ hrs. (2) Stabilize component at room temperature for 1 hr. then measure value.	
	Visual	No evidence of mechanical damage			
Loading Life in Moisture	$\Delta R/R$	$\pm(3\%+0.1\Omega)$ max. of the initial value	50m Ω max.	(1) Temp.: 40 \pm 2 $^{\circ}$ C RH: 90-95% Voltage Cycle: on 90 min. (rated voltage) off 30 min. Duration: 1000 $^{+48}$ hrs. (2) Stabilize component at room temperature for 1 hr. then measure value.	
	Visual	No evidence of mechanical damage			

Packaging of Chip Component



Automatic Insertion Packaging



TAPE AND REEL

REEL DIMENSIONS

millimeters (inches)

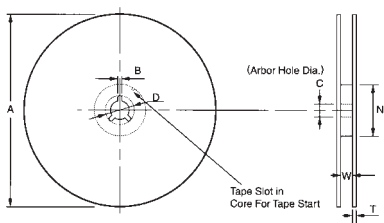

Tape Size	A Max.	B Min.	C	D Min.	N Min.	W	T Max.
8mm	178 (7)	1.50 (0.059)	13.0±0.50 (0.512±0.020)	20.2 (0.795)	50 (1.969)	10.0±1.50 (0.394±0.059)	2.50 (0.098)
	260 (10)						

Metric dimensions will govern.
English measurements rounded and for reference only.

millimeters (inches)

PUNCHED TAPE CONFIGURATION 8MM TAPE ONLY

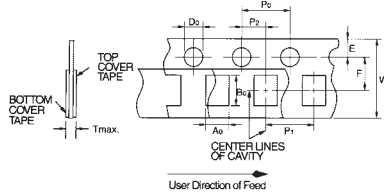

Tape Size	D ₀	E	P ₀	P ₂	W	F
8mm	1.50 ^{+0.10} / _{-0.000} (0.059 ^{+0.004} / _{-0.000})	1.75±0.10 (0.069±0.004)	4.0±0.10 (0.157±0.004)	2.00±0.05 (0.079±0.002)	8.00±0.20 (0.135±0.008)	3.50±0.05 (0.138±0.002)

VARIABLE DIMENSIONS

Style	P ₁	A ₀	B ₀	T max.
CR/CJ03 CR/CJ05	2.00±0.10 (0.079±0.004)	0.65±0.10 (0.026±0.004)	1.15±0.10 (0.045±0.004)	0.60 (0.024)
CR/CJ/FR10	4.00±0.10 (0.157±0.004) or 2.00±0.10 (0.079±0.004)	1.10±0.20 (0.043±0.008)	1.90±0.20 (0.075±0.008)	1.10 (0.043)
CR/CJ/FR21	4.00±0.10 (0.157±0.004)	1.65±0.20 (0.065±0.008)	2.40±0.20 (0.094±0.008)	
CR/CJ/FR32		2.00±0.20 (0.079±0.008)	3.60±0.20 (0.142±0.008)	
CRB1A		1.90±0.20 (0.075±0.008)	1.90±0.20 (0.075±0.008)	
CRA3A CRB3A CRC3A		2.00±0.20 (0.079±0.008)	3.60±0.20 (0.142±0.008)	
CRB2A		2.00±0.10 (0.079±0.004)	1.25±0.20 (0.049±0.008)	

PUNCHED CARRIER

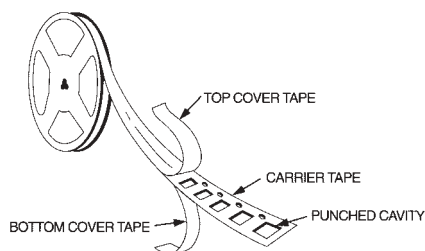

Recommended Land Patterns



RECOMMENDED LAND PATTERNS IS REFERRED THE FOLLOWING FOR EXAMPLE

millimeters (inches)

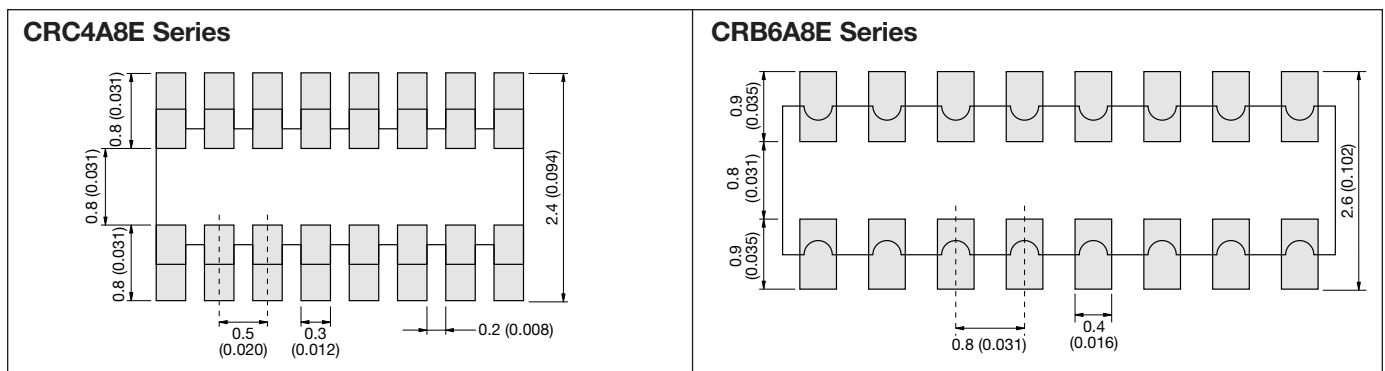
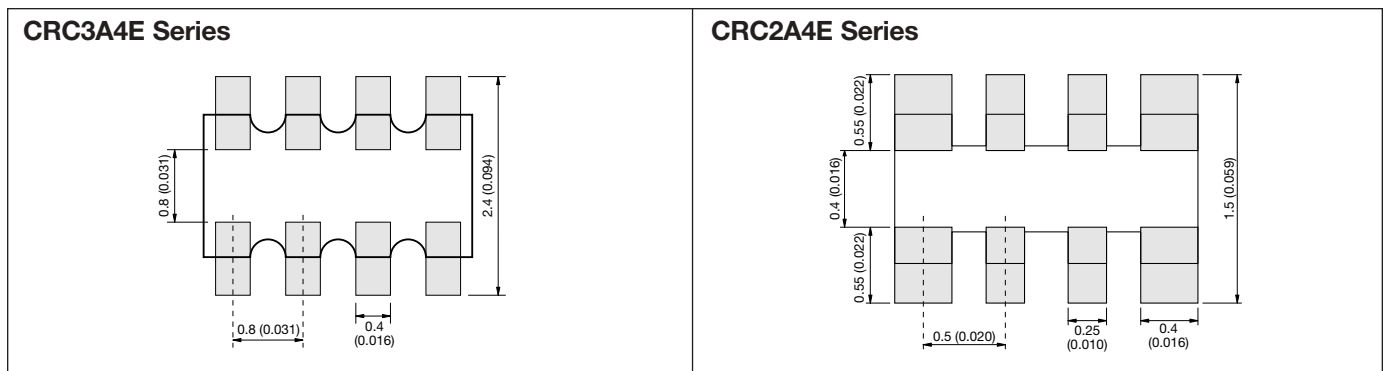
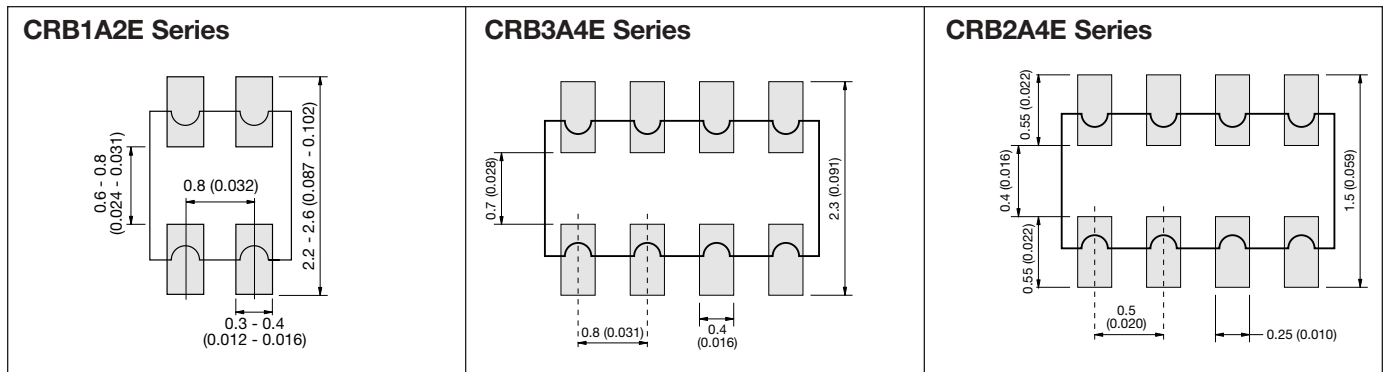
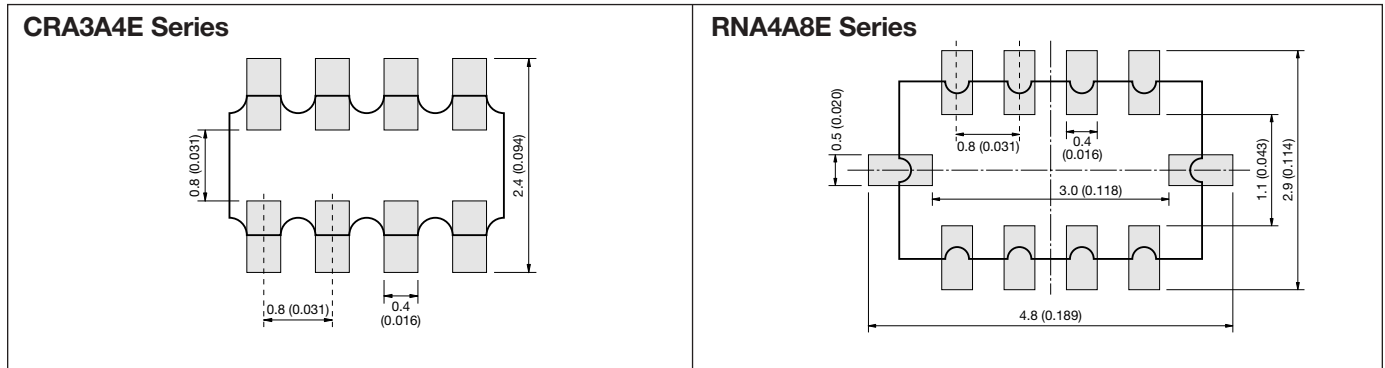



SAMPLE KIT PART NUMBERS

Part Number	Description
CRJ-E6-Kit	Combination 0603, 0805, 1206, 5% parts 21 values per case size 100 pcs. per value (approx.)
CR05-E12-Kit	0402, 5% parts 63 values 100 pcs. per value
CR10J-E12-Kit	0603, 5% parts 63 values 100 pcs. per value (approx.)
CR21J-E12-Kit	0805, 5% parts 63 values 100 pcs. per value (approx.)
CR32J-E12-Kit	1206, 5% parts 63 values 100 pcs. per value (approx.)
CR05F-E24-Kit	0402, 1% parts 63 values 100 pcs. per value
CR10F-E24-Kit	0603, 1% parts 63 values 100 pcs. per value
CR-ARRAY-E6-Kit	Arrays, Various styles, CRA, CRB, CRC, RNA, 5% 13 values per style (approx.) 20 pcs. per value