

# Precision Frequency Standard



2111 Comprehensive Drive

Aurora, Illinois 60505

Phone: 630-851-4722

Fax: 630-851-5040

www.conwin.com

US Headquarters

630-851-4722:

European Headquarters:

+353-61-472221



**14 Pin DIP Package  
OCXO Series**

### Description

The Connor-Winfield 14 Pin DIP Oven Stabilized Crystal Controlled Oscillators (OCXO) series and Voltage Controlled Oven Stabilized Crystal Controlled Oscillators (VCOCXO) series are designed for use in applications requiring stabilities of +/-0.05ppm to +/-0.25ppm over the commercial or the industrial temperature ranges.

### Features

Frequency Range: 1.6 MHz to 20 MHz  
OCXO - Fixed Frequency  
VCOCXO - Voltage Controlled  
3.3V or 5.0V Operation  
LVCMOS or HCMOS Output Logic  
Frequency Stabilities Available:

PF150xx Series: ±0.05ppm

PF151xx / PF161xx Series: ±0.10ppm

PF152xx / PF162xx Series: ±0.15ppm

PF153xx / PF163xx Series: ±0.20ppm

PF154xx / PF164xx Series: ±0.25ppm

Temperature Ranges Available:

PF15xxx Series: 0 to 70°C

PF16xxx Series: -40 to 85°C

Low Jitter < 1pS RMS

14 Pin DIP Package

RoHS Compliant / Lead Free



**14x20mm Surface Mount Package  
OCXO Series**

### Description

The Connor-Winfield 14x20mm Oven Stabilized Crystal Controlled Oscillators (OCXO series) and Voltage Controlled Oven Stabilized Crystal Controlled Oscillators (VCOCXO series) are designed for use in applications requiring stabilities of +/-0.05ppm to +/-0.25ppm over the commercial or the industrial temperature ranges.

### Features

Frequency Range: 1.6 to 20 MHz  
OCXO - Fixed Frequency  
VCOCXO - Voltage Controlled  
3.3V or 5.0V Operation  
LVCMOS or HCMOS Output Logic  
Frequency Stabilities Available:

PF250xx Series: ±0.05ppm

PF251xx / PF261xx Series: ±0.10ppm

PF252xx / PF262xx Series: ±0.15ppm

PF253xx / PF263xx Series: ±0.20ppm

PF254xx / PF264xx Series: ±0.25ppm

Temperature Ranges Available:

PF25xxx Series: 0 to 70°C

PF26xxx Series: -40 to 85°C

Low Jitter < 1pS RMS

Surface Mount Package

Tape and Reel Packing

RoHS Compliant / Lead Free

### Standard Frequencies that are Available\*

6.4 MHz	8.192 MHz	9.72 MHz	10.0 MHz
12.8 MHz	16.384 MHz	19.44 MHz	20.0 MHz

### Ordering Information

PF	1	5	1	L	F	-	010.0M
<b>Type:</b> Precision Frequency Standard OCXO VCOCXO	<b>Package Type:</b> 1 = 14 Pin DIP 2 = SMT 20x14mm	<b>Temperature Range:</b> 5 = 0 to 70° C 6 = -40 to 85° C	<b>Frequency Stability:</b> 0 = +/-0.05ppm 1 = +/-0.10ppm 2 = +/-0.15ppm 3 = +/-0.20ppm 4 = +/-0.25ppm	<b>Supply Voltage / Output:</b> L = 3.3Vdc / LVCMOS H = 5.0Vdc / HCMOS	<b>Output:</b> F = Fixed Frequency V = Voltage Controlled		<b>Output Frequency:</b> M = MHz xxx.xxM

Frequencies available from the factory for small quantities or quick deliveries, additional frequencies are available.

Specifications subject to change without notice. All dimensions in inches. © Copyright 2008 The Connor-Winfield Corporation



Bulletin	Cx123
Page	1 of 4
Revision	00
Date	21 May 2008



### PF15xxx / PF16xxx - Series



### PF25xxx / PF26xxx - Series



DIP Package Model Number	PF150LF	PF150HF	PF150LV	PF150HV	Note:
SM Package Model Number	PF250LF	PF250HF	PF250LV	PF250HV	
Frequency Range	1.6 to 20 MHz				1.2
Frequency Stability	±0.05ppm				
Temperature Range	0 to 70°C				
Supply Voltage	3.3 Vdc	5.0 Vdc	3.3 Vdc	5.0 Vdc	
OCXO / VCOCXO	OCXO	OCXO	VCOCXO	VCOCXO	

DIP Package Model Number	PF151LF	PF151HF	PF151LV	PF151HV	Note:
SM Package Model Number	PF251LF	PF251HF	PF251LV	PF251HV	
Frequency Range	1.6 to 20 MHz				1.2
Frequency Stability	±0.10ppm				
Temperature Range	0 to 70°C				
Supply Voltage	3.3 Vdc	5.0 Vdc	3.3 Vdc	5.0 Vdc	
OCXO / VCOCXO	OCXO	OCXO	VCOCXO	VCOCXO	

DIP Package Model Number	PF161LF	PF161HF	PF161LV	PF161HV	Note:
SM Package Model Number	PF261LF	PF261HF	PF261LV	PF261HV	
Frequency Range	1.6 to 20 MHz				1.2
Frequency Stability	±0.10ppm				
Temperature Range	-40 to 85°C				
Supply Voltage	3.3 Vdc	5.0 Vdc	3.3 Vdc	5.0 Vdc	
OCXO / VCOCXO	OCXO	OCXO	VCOCXO	VCOCXO	

DIP Package Model Number	PF152LF	PF152HF	PF152LV	PF152HV	Note:
SM Package Model Number	PF252LF	PF252HF	PF252LV	PF252HV	
Frequency Range	1.6 to 20 MHz				1.2
Frequency Stability	±0.15ppm				
Temperature Range	0 to 70°C				
Supply Voltage	3.3 Vdc	5.0 Vdc	3.3 Vdc	5.0 Vdc	
OCXO / VCOCXO	OCXO	OCXO	VCOCXO	VCOCXO	

DIP Package Model Number	PF162LF	PF162HF	PF162LV	PF162HV	Note:
SM Package Model Number	PF262LF	PF262HF	PF262LV	PF262HV	
Frequency Range	1.6 to 20 MHz				1.2
Frequency Stability	±0.15ppm				
Temperature Range	-40 to 85°C				
Supply Voltage	3.3 Vdc	5.0 Vdc	3.3 Vdc	5.0 Vdc	
OCXO / VCOCXO	OCXO	OCXO	VCOCXO	VCOCXO	

DIP Package Model Number	PF153LF	PF153HF	PF153LV	PF153HV	Note:
SM Package Model Number	PF253LF	PF253HF	PF253LV	PF253HV	
Frequency Range	1.6 to 20 MHz				1.2
Frequency Stability	±0.20ppm				
Temperature Range	0 to 70°C				
Supply Voltage	3.3 Vdc	5.0 Vdc	3.3 Vdc	5.0 Vdc	
OCXO / VCOCXO	OCXO	OCXO	VCOCXO	VCOCXO	

DIP Package Model Number	PF163LF	PF163HF	PF163LV	PF163HV	Note:
SM Package Model Number	PF263LF	PF263HF	PF263LV	PF263HV	
Frequency Range	1.6 to 20 MHz				1.2
Frequency Stability	±0.20ppm				
Temperature Range	-40 to 85°C				
Supply Voltage	3.3 Vdc	5.0 Vdc	3.3 Vdc	5.0 Vdc	
OCXO / VCOCXO	OCXO	OCXO	VCOCXO	VCOCXO	

DIP Package Model Number	PF154LF	PF154HF	PF154LV	PF154HV	Note:
SM Package Model Number	PF254LF	PF254HF	PF254LV	PF254HV	
Frequency Range	1.6 to 20 MHz				1.2
Frequency Stability	±0.25ppm				
Temperature Range	0 to 70°C				
Supply Voltage	3.3 Vdc	5.0 Vdc	3.3 Vdc	5.0 Vdc	
OCXO / VCOCXO	OCXO	OCXO	VCOCXO	VCOCXO	

DIP Package Model Number	PF164LF	PF164HF	PF164LV	PF164HV	Note:
SM Package Model Number	PF264LF	PF264HF	PF264LV	PF264HV	
Frequency Range	1.6 to 20 MHz				1.2
Frequency Stability	±0.25ppm				
Temperature Range	-40 to 85°C				
Supply Voltage	3.3 Vdc	5.0 Vdc	3.3 Vdc	5.0 Vdc	
OCXO / VCOCXO	OCXO	OCXO	VCOCXO	VCOCXO	

Note:  
1.2) Frequency stability vs. change in temperature.

### FEATURES

OCXO - Fixed Frequency  
 VCOCXO - Voltage Controlled  
 Frequency Range: 1.6 to 20 MHz  
 3.3V or 5.0V Operation  
 LVCMOS / HCMOS Output Logic  
 PF15xxx / PF16xxx Series -14 Pin DIP Package  
 PF25xxx / PF26xxx Series -Surface Mount Package  
 Frequency Stabilities Available:  
 PF150xx / PF160xx Series: ±0.05ppm  
 PF151xx / PF161xx Series: ±0.10ppm  
 PF251xx / PF261xx Series: ±0.10ppm  
 PF152xx / PF162xx Series: ±0.15ppm  
 PF252xx / PF262xx Series: ±0.15ppm  
 PF153xx / PF163xx Series: ±0.20ppm  
 PF253xx / PF263xx Series: ±0.20ppm  
 PF154xx / PF164xx Series: ±0.25ppm  
 PF254xx / PF264xx Series: ±0.25ppm  
 Temperature Ranges Available:  
 PF15xxx: 0 to 70°C  
 PF16xxx: -40 to 85°C  
 Low Jitter < 1ps RMS  
 Tape and Reel Packaging  
 RoHS Compliant / Lead Free

### PIN CONNECTIONS

Pin	Function
1	OCXO - N/C
7	VCOCXO - Voltage Control
8	Ground (Case)
14	Output
14	Vcc

### ORDERING INFORMATION

PF151LF - 010.0 M  
 OCXO SERIES      CENTER FREQUENCY

US Headquarters:  
630-851-4722  
European Headquarters:  
+ 353-61-47221

Bulletin	Cx123
Page	2 of 4
Revision	00
Date	21 May 2008

## 3.3V LVC MOS Model Specifications

### ABSOLUTE MAXIMUM RATINGS

PARAMETER	UNITS	MINIMUM	NOMINAL	MAXIMUM	UNITS	NOTE
Storage Temperature		-55	-	125	°C	
Supply Voltage	(Vcc)	-0.5	-	4.5	Vdc	
Control Voltage	(Vc)	-0.5	-	4.5	Vdc	

TABLE 1.3

### OPERATING SPECIFICATIONS

PARAMETER	MINIMUM	NOMINAL	MAXIMUM	UNITS	NOTE
Frequency Calibration	-1.0	-	1.0	ppm	1.3, 4.3
Frequency Stability	See Page 2			ppm	2.3
Frequency vs. Change in Supply Voltage	-0.05	-	0.05	ppm	3.3
Aging (Daily)	-30	-	30	ppb	4.3
Aging (1st year)	-1.0	-	1.0	ppm	
Total Frequency Tolerance (20 years)	-4.6	-	4.6	ppm	5.3
Supply Voltage	(Vcc)	3.13	3.3	3.47	Vdc
Supply Power (0 to 70°C)	-	-	1.5	Watts	
Supply Power (-40 to 85°C)	-	-	2.7	Watts	
Phase Jitter (BW =10Hz to Fo/2)	-	-	3	pS RMS	
Phase Jitter (BW =10KHz to Fo/2)	-	-	1	pS RMS	
Period Jitter	-	-	1	pS RMS	
Allan Variance (1 Second)	-	1.00 E-10	-		
SSB Phase Noise at 10Hz offset	-	-90	-	dBc/Hz	6.3
SSB Phase Noise at 100Hz offset	-	-120	-	dBc/Hz	6.3
SSB Phase Noise at 1KHz offset	-	-140	-	dBc/Hz	6.3
SSB Phase Noise at 10KHz offset	-	-150	-	dBc/Hz	6.3
Start-Up Time: Oscillator	-	-	35	ms	
Warm Up Time	-	-	5	Minutes	7.3

TABLE 2.3

### VCOCXO CHARACTERISTICS

PARAMETER	MINIMUM	NOMINAL	MAXIMUM	UNITS	NOTE
Control Voltage Range	(Vc)	0.3	1.5	3.0	Vdc
Frequency at Vc=0.3 Vdc	-	-7	-5	ppm	8.3
Frequency at Vc=3.0 Vdc	5	7	-	ppm	8.3
Slope of Frequency Adjust	3.7	-	-	ppm/V	
Input Impedance	100k	-	-	Ohm	

TABLE 3.3

### LVC MOS OUTPUT CHARACTERISTICS

PARAMETER	MINIMUM	NOMINAL	MAXIMUM	UNITS	NOTE
LOAD	-	15	-	pF	
Voltage (High)	(Voh)	2.6	-	Vdc	
(Low)	(Vol)	-	0.4	Vdc	
Current (High)	(Ioh)	-4	-	mA	
(Low)	(Iol)	-	4	mA	
Duty Cycle at 50% of Vcc	45	50	55	%	
Rise / Fall Time 10% to 90%	-	-	6	nS	

TABLE 4.3

### PACKAGE CHARACTERISTICS

PACKAGE CHARACTERISTICS	TABLE 5.3
PF1xxxx-Series DIP Package	14 pin DIP, hermetically sealed, grounded, welded package.
PF2xxxx-Series Surface Mount Package	Surface Mount, Non-hermetic package consisting of an FR4 substrate with grounded metal cover.

TABLE 5.3

#### Notes:

- Initial calibration @ 25C. VCOCXO model Vc = 1.50 Vdc.
- Frequency stability vs. Change in temperature, referenced to 25C.
- Frequency stability per 5% change in supply voltage.
- At the time of shipment after 48 hours of operation.
- Inclusive of calibration, operating temperature range, supply voltage change, shock and vibration 20 years aging, VCOCXO models Vc=1.5V.
- Typical phase noise, results will vary depending on center frequency. The phase noise shown are typical for 20 MHz.
- Measured @ 25C, within 5 minutes, the unit will be within +/-0.1ppm of its reference frequency, measured after 30 minutes of continuous operation at a stable 25C.
- VCOCXO models pullability referenced to Fo @ 25°C, Positive Transfer Characteristic.

## 5.0V HCM OS Model Specifications

### ABSOLUTE MAXIMUM RATINGS

PARAMETER	UNITS	MINIMUM	NOMINAL	MAXIMUM	UNITS	NOTE
Storage Temperature		-55	-	125	°C	
Supply Voltage	(Vcc)	-0.5	-	4.5	Vdc	
Control Voltage	(Vc)	-0.5	-	4.5	Vdc	

TABLE 6.3

### OPERATING SPECIFICATIONS

PARAMETER	MINIMUM	NOMINAL	MAXIMUM	UNITS	NOTE
Frequency Calibration	-1.0	-	1.0	ppm	9.3, 12.3
Frequency Stability	See Page 2			ppm	10.3
Frequency vs. Change in Supply Voltage	-0.05	-	0.05	ppm	11.3
Aging (Daily)	-30	-	30	ppb	123
Aging (1st year)	-1.0	-	1.0	ppm	
Total Frequency Tolerance (20 years)	-4.6	-	4.6	ppm	13.3
Supply Voltage	(Vcc)	4.75	5.0	5.25	Vdc
Supply Power (0 to 70°C)	-	-	1.5	Watts	
Supply Power (-40 to 85°C)	-	-	2.7	Watts	
Phase Jitter (BW =10Hz to Fo/2)	-	-	3	pS RMS	
Phase Jitter (BW =10KHz to Fo/2)	-	-	1	pS RMS	
Period Jitter	-	-	1	pS RMS	
Allan Variance (1 Second)	-	1.00 E-10	-		
SSB Phase Noise at 10Hz offset	-	-90	-	dBc/Hz	14.3
SSB Phase Noise at 100Hz offset	-	-120	-	dBc/Hz	14.3
SSB Phase Noise at 1KHz offset	-	-140	-	dBc/Hz	14.3
SSB Phase Noise at 10KHz offset	-	-150	-	dBc/Hz	14.3
Start-Up Time: Oscillator	-	-	35	ms	
Warm Up Time	-	-	5	Minutes	15.3

TABLE 7.3

### VCOCXO CHARACTERISTICS

PARAMETER	MINIMUM	NOMINAL	MAXIMUM	UNITS	NOTE
Control Voltage Range	(Vc)	0.5	2.0	4.1	Vdc
Frequency at Vc=0.5 Vdc	-	-7	-5	ppm	16.3
Frequency at Vc=4.1 Vdc	5	7	-	ppm	16.3
Slope of Frequency Adjust	3.7	-	-	ppm/V	
Input Impedance	100k	-	-	Ohm	

TABLE 8.3

### HCM OS OUTPUT CHARACTERISTICS

PARAMETER	MINIMUM	NOMINAL	MAXIMUM	UNITS	NOTE
LOAD	-	15	-	pF	
Voltage (High)	(Voh)	Vcc-0.5	-	Vdc	
(Low)	(Vol)	-	0.4	Vdc	
Current (High)	(Ioh)	-4	-	mA	
(Low)	(Iol)	-	4	mA	
Duty Cycle at 50% of Vcc	45	50	55	%	
Rise / Fall Time 10% to 90%	-	-	6	nS	

TABLE 9.3

### PACKAGE CHARACTERISTICS

PACKAGE CHARACTERISTICS	TABLE 10.3
PF1xxxx-Series DIP Package	14 pin DIP, hermetically sealed, grounded, welded package.
PF2xxxx-Series Surface Mount Package	Surface Mount, Non-hermetic package consisting of an FR4 substrate with grounded metal cover.

TABLE 10.3

#### Notes:

- Initial calibration @ 25C. VCOCXO model Vc = 2.0 Vdc.
- Frequency stability vs. Change in temperature, referenced to 25C.
- Frequency stability per 5% change in supply voltage.
- At the time of shipment after 48 hours of operation.
- Inclusive of calibration, operating temperature range, supply voltage change, shock and vibration 20 years aging, VCOCXO models Vc=2.0V.
- Typical phase noise, results will vary depending on center frequency. The phase noise shown are typical for 20 MHz.
- Measured @ 25C, within 5 minutes, the unit will be within +/-0.1ppm of its reference frequency, measured after 30 minutes of continuous operation at a stable 25C.
- VCOCXO models pullability referenced to Fo @ 25°C, Positive Transfer Characteristic.

US Headquarters:  
630-851-4722  
European Headquarters:  
+ 353-61-472221

Bulletin	Cx123
Page	3 of 4
Revision	00
Date	21 May 2008

## 14 Pin DIP Package Environmental Characteristics

### ENVIRONMENTAL CHARACTERISTICS

**Temperature Cycle:** Per MIL-STD-883, Method 1010, Condition B. -55°C to 125°C, 300 cycles, 10 minute dwell, 1minute transition.

**Gross Leak Test:** Per MIL-STD-202, Method 112, Condition D. No Bubbles in flourinert (FC-43) at 125°C ±5°C for 20 seconds.

### SOLDERING

**Pin Solderability:** Per MIL-STD-883, Method 2003. 8 hour steam age prior to 254°C ±5°C Solder pot dip, 95% Coverage.

**Resistance to Solder Heat:** Per MIL-STD-202, Method 210, Condition C. Wave: Topside board-mount product, 260°C ±5°C for 20 seconds.

### MECHANICAL CHARACTERISTICS

**Vibration:** Per MIL-STD-202, Method 204, Condition A. 10G's peak, 10Hz to 500Hz, 15 minute cycles 12 times each perpendicular axis.

**Shock:** Per MIL-STD-202, Method 213, Condition F. 1500G's, 0.5ms, half sine, 3 shocks per direction.

**Moisture Resistance:** Per MIL-STD-202, Method 106. 95% RH @ 65°C, 10 cycles 10°C to 65°C.

## Surface Mount Package Environmental Characteristics

### ENVIRONMENTAL CHARACTERISTICS

**Temperature Cycle:** Per MIL-STD-883, Method 1010, Condition B. -55°C to 125°C, 300 cycles, 10 minute dwell, 1minute transition.

### MECHANICAL CHARACTERISTICS

**Vibration:** Per MIL-STD-202, Method 204, Condition A. 10G's peak, 10Hz to 500Hz, 15 minute cycles 12 times each perpendicular axis.

**Shock:** Per MIL-STD-202, Method 213, Condition F. 1500G's, 0.5ms, half sine, 3 shocks per direction.

**Moisture Resistance:** Per MIL-STD-202, Method 106. 95% RH @ 65°C, 10 cycles 10°C to 65°C.

### 14 Pin DIP Package Outline

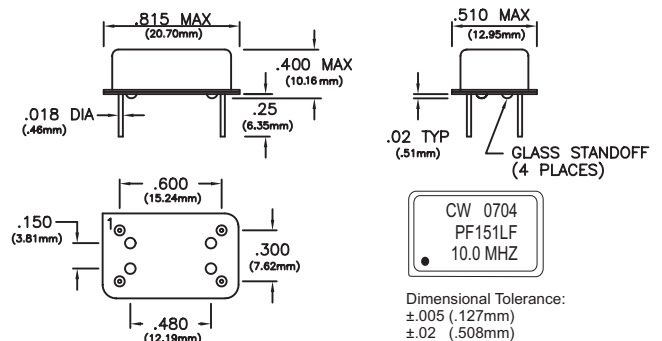

### Surface Mount Package Outline

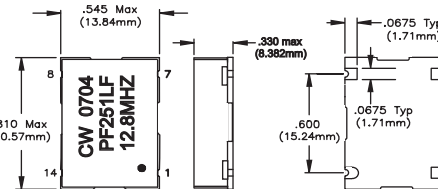

### Suggested Pad Layout

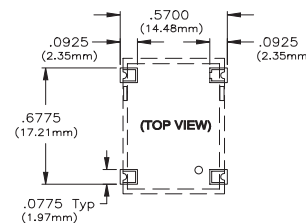

### Keep Out Area

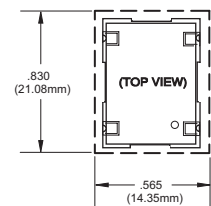

### Solder Profile

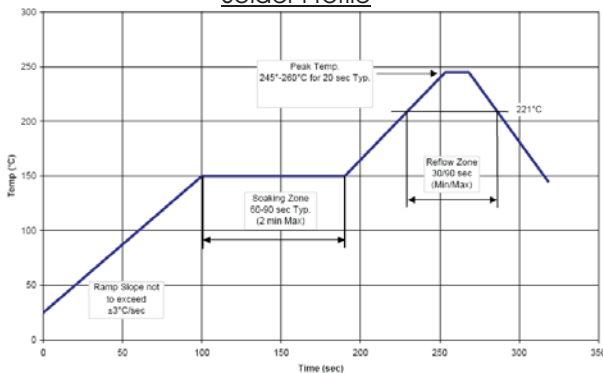

### Tape and Reel Information

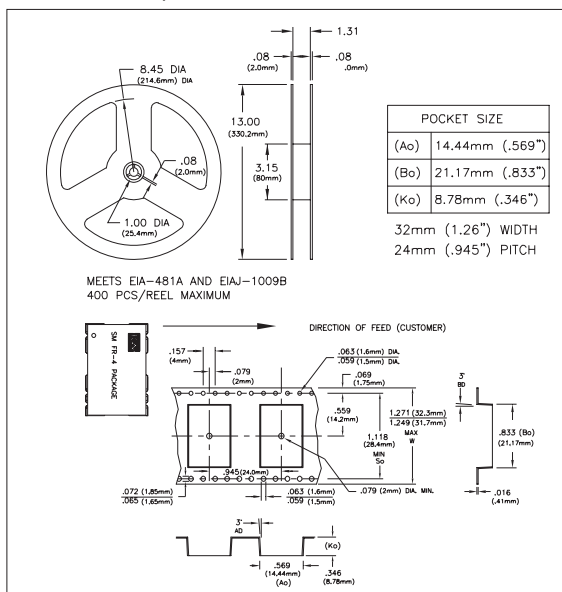

### Output Waveform

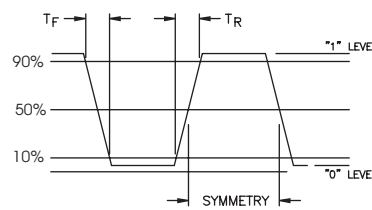

### Pin Connections

Pin	Function
1	OCXO - N/C
7	VCOCXO - Voltage Control
8	Ground (Case)
14	Vcc

### Test Circuit

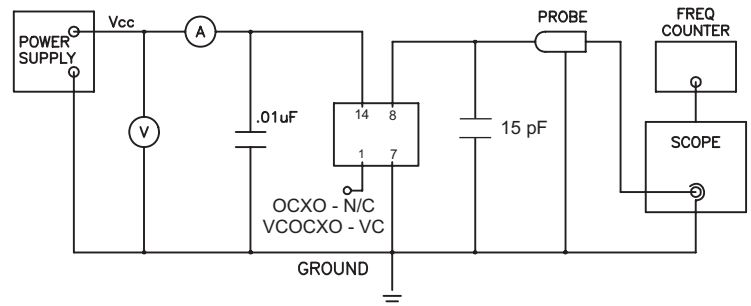

US Headquarters:  
630-851-4722  
European Headquarters:  
+ 353-61-47221

Bulletin	Cx123
Page	4 of 4
Revision	00
Date	21 May 2008