



## Features

- Higher operating temperatures
- Fully potted
- Designed to meet UL1950 and EN60950-1 (basic insulation)
- CE mark available (75V-input models)
- Fully isolated, 1500Vdc guaranteed
- 25/30/35/40W output power
- Standard pinout! Smaller size!
- New 2" x 3" package fits 3" x 3" footprint
- $\pm 5V$ ,  $\pm 12V$  or  $\pm 15V$  outputs
- Four input voltage ranges:  
10-36V, 18-36V  
18-75V, 36-75V
- High efficiencies (to 88%)
- Fully I/O protected
- $V_{out}$  trim and on/off control
- Modifications and customs for OEM's

DATEL's BMP Models are fully potted, 25-40 Watt, dual-output DC/DC converters designed to meet UL1950 and EN60950-1 safety standards. The combination the BMP's higher efficiencies and thermally conductive potting compound enables these devices to achieve higher operating temperatures without derating. The 2" x 3" BMP "footprint" conforms to the standard pinout and pin geometries of most 3" x 3" devices (a 33% space savings) while delivering 60% more power (40W vs. 25W).

Applicable to a wide range of telecom, computer and other OEM applications, BMP Model DC/DC's offer  $\pm 5V$ ,  $\pm 12V$  and  $\pm 15V$  outputs. They operate from four different input voltage ranges with total available output being a function of the selected range. "Q12" models operate from 10-36V and deliver 25W. "Q48" models operate from 18-75V and deliver 30W. For "D24" and "D48" models, the input ranges and output powers are 18-36V at 35W and 36-75V at 40W, respectively.

These devices employ corrosion-resistant metal cases with plastic headers. Heat-generating transformer cores and power semiconductors are mounted directly to the cases, which have threaded inserts for optional add-on heat sinks or pcb mounting. Temperature derating information is provided for operation with and without heat sinks and forced air flow.

All devices feature input pi filters, input overvoltage shutdown, output overvoltage protection, output current limiting, and thermal shutdown. UL, CSA, EN and IEC compliance testing is currently in progress (75V-input devices will be CE marked) as are full EMI/EMC characterizations. Contact DATEL for the latest available information.

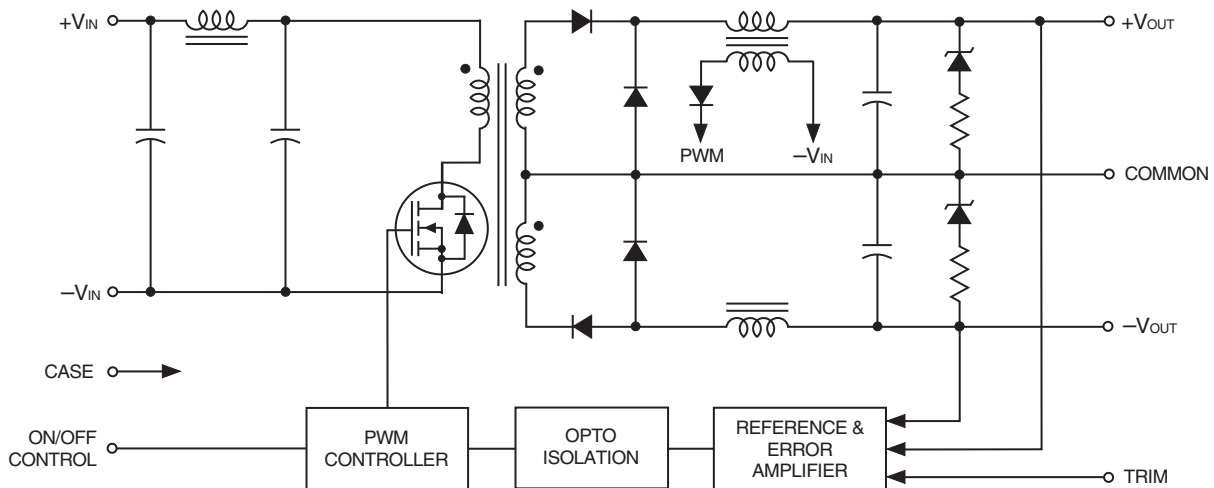

Figure 1. Simplified Schematic

Typical topology is shown



## Performance Specifications and Ordering Guide <sup>①</sup>

Model	Output						Input			Efficiency		Package (Case, Pinout)
	V <sub>OUT</sub> (Volts)	I <sub>OUT</sub> (Amps)	R/N (mVp-p) <sup>②</sup>		Regulation (Max.)		V <sub>IN</sub> Nom. (Volts)	Range (Volts)	I <sub>IN</sub> <sup>④</sup> (mA)	Min.	Typ.	
			Typ.	Max.	Line	Load <sup>③</sup>						
BMP-5/4-Q12	±5	±4	60	120	±0.5%	±1%	24	10-36	15/1225	82%	85%	C11, P15
BMP-5/4-D24	±5	±4	75	125	±0.5%	±1%	24	18-36	15/1696	84%	86%	C11, P15
BMP-5/4-Q48	±5	±4	75	125	±0.5%	±1%	48	18-75	25/735	82%	85%	C11, P15
BMP-5/4-D48	±5	±4	75	125	±0.5%	±1%	48	36-75	20/980	83%	85%	C11, P15
BMP-12/1.65-Q12	±12	±1.65	60	100	±0.5%	±1%	24	10-36	20/1224	83%	85%	C11, P15
BMP-12/1.65-D24	±12	±1.65	60	100	±0.5%	±1%	24	18-36	15/1667	85%	87%	C11, P15
BMP-12/1.65-Q48	±12	±1.65	75	120	±0.5%	±1%	48	18-75	15/727	84%	86%	C11, P15
BMP-12/1.65-D48	±12	±1.65	75	125	±0.5%	±1%	48	36-75	15/948	85%	87%	C11, P15
BMP-15/1.3-Q12	±15	±1.3	60	125	±0.5%	±1%	24	10-36	20/1225	83%	85%	C11, P15
BMP-15/1.3-D24	±15	±1.3	60	125	±0.5%	±1%	24	18-36	15/1648	85%	88%	C11, P15
BMP-15/1.3-Q48	±15	±1.3	75	125	±0.5%	±1%	48	18-75	25/727	84%	86%	C11, P15
BMP-15/1.3-D48	±15	±1.3	60	125	±0.5%	±1%	48	36-75	20/934	84%	87%	C11, P15

- ① Typical at T<sub>A</sub> = +25°C under nominal line voltage and balanced "full-load" conditions unless otherwise noted.  
For BMP devices, "full load" is a function of each device's input voltage range. See Output Power Considerations and Technical Notes for more details.
- ② Ripple/Noise (R/N) measured over a 20MHz bandwidth.
- ③ Balanced loads, 10% to 100% load.
- ④ Nominal line voltage, no-load/full-load conditions.

### PART NUMBER STRUCTURE

**BMP-5/4-D48-C**

Output Configuration:  
B = Bipolar

Fully Potted Metal Package

Nominal Output Voltages:  
±5, ±12 or ±15 Volts

RoHS-6 compliant\*

Input Voltage Range:  
Q12 = 10-36 Volts (24V nominal)  
D24 = 18-36 Volts (24V nominal)  
Q48 = 18-75 Volts (48V nominal)  
D48 = 36-75 Volts (48V nominal)

Maximum Output Current  
in Amps from each output

\* Contact Murata Power Solutions (Date) for availability.

### OUTPUT POWER CONSIDERATIONS

As shown below, BMP Model DC/DC Converters are classified by output power. For dual-output devices, the total output power from the two outputs can not exceed the rated power. For example, "Q48" models have a maximum output power of 30W. Therefore, if the +Output is sourcing 20 Watts, the -Output is limited to sourcing 10 Watts ensuring the total output power does not exceed 30 Watts.

Model	Maximum Output Power
Q12	25 Watts
Q48	30 Watts
D24	35 Watts
D48	40 Watts

**MECHANICAL SPECIFICATIONS**

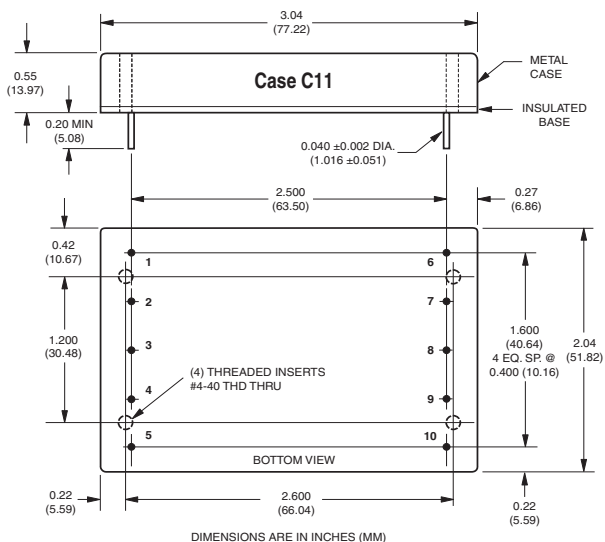

**Optional Heat Sink Kit**  
(Part Number HS-23 <non-RoHS> or HS-23-C <RoHS>)

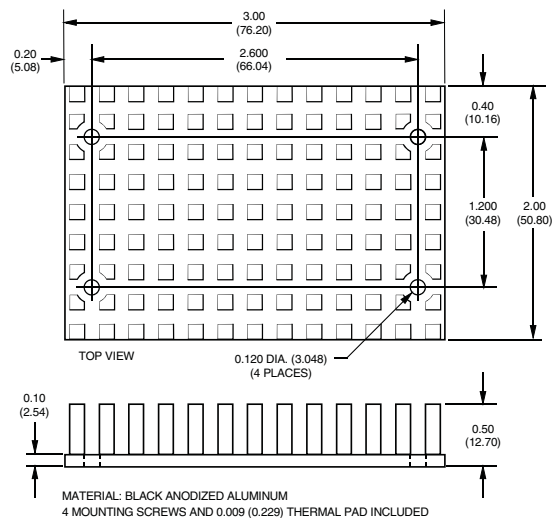

**I/O Connections**

Pin	Function P15
1	No Pin
2	-Input
3	+Input
4	Case
5	On/Off Control*
6	-Output
7	No Pin
8	Common
9	+Output
10	Trim

\* See note 4 on next page.

Dimensions are in inches (mm shown for ref. only).

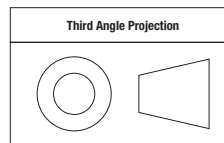

Tolerances (unless otherwise specified):

.XX ± 0.02 (0.5)

.XXX ± 0.010 (0.25)

Angles ± 2°

Components are shown for reference only.

### Performance/Functional Specifications

Typical @ T<sub>A</sub> = +25°C under nominal line voltage and "full-load" conditions, unless noted. ① ②

Input	
<b>Input Voltage Range:</b>	
Q12 Models	10-36 Volts (24V nominal)
D24 Models	18-36 Volts (24V nominal)
Q48 Models	18-75 Volts (48V nominal)
D48 Models	36-75 Volts (48V nominal)
<b>Input Current</b>	See Ordering Guide
<b>Input Filter Type</b> ③	Pi
<b>Overvoltage Shutdown:</b>	
Q12 and D24 Models	40 Volts
Q48 and D48 Models	80 Volts
<b>Reverse-Polarity Protection</b>	Yes (Instantaneous, 6A maximum)
<b>On/Off Control (Pin 5)</b> ④	TTL high (or open) = on, low = off
Output	
<b>V<sub>OUT</sub> Accuracy (50% load)</b>	±1%, maximum
<b>Temperature Coefficient</b>	±0.02% per °C
<b>Ripple/Noise (20MHz BW)</b> ③	See Ordering Guide
<b>Line/Load Regulation</b>	See Ordering Guide
<b>Efficiency</b>	See Ordering Guide
<b>Isolation Voltage</b> ⑤	1500Vdc, minimum
<b>Isolation Capacitance</b>	620pF
<b>Current Limiting</b>	Continuous, auto-recovery
<b>Overvoltage Protection</b>	Zener/transorb clamps, magnetic feedback
Dynamic Characteristics	
<b>Transient Response (50% load step)</b>	300µsec max. to ±1.5% of final value
<b>Switching Frequency</b>	125kHz (±10%)
Environmental	
<b>Operating Temperature (ambient):</b>	
Without Derating	-40 to +60°C (Model dependent)
With Derating	to +90°C (See Derating Curves)
Maximum Case Temperature	+90°C
<b>Storage Temperature</b>	-40 to +105°C
<b>Relative Humidity</b>	To 85°C /85% RH, non-condensing
Physical	
<b>Safety</b>	Designed to meet UL/cUL/EN/IEC 60950-1
<b>Dimensions</b>	2.04" x 3.04" x 0.55" (51.8 x 77.2 x 14mm)
<b>Shielding</b>	5-sided
<b>Case Connection</b>	Pin 4
<b>Case Material</b>	Aluminum, black anodized finish with plastic header
<b>Flammability Rating</b>	UL94V-0
<b>Pin Material</b>	Gold-plated copper alloy with nickel underplate
<b>Weight</b>	6 ounces (170 grams)

① These converters require a minimum 10% loading on each output to maintain specified regulation. Operation under no-load conditions will not damage these devices; however they may not meet all listed specifications.

② "Full load" varies by part number and is determined by the input voltage range as indicated by the part number suffix. See Technical Notes and Output Power Considerations.

③ Application-specific input/output filtering can be recommended or perhaps added internally upon request. Contact DATEL Applications Engineering for details.

④ Applying a voltage to the On/Off Control pin when no input power is applied to the converter can cause permanent damage to the converter.

⑤ Listed specification is for input-to-output isolation. Input-to-case and output-to-case isolation is 1000Vdc, minimum.

### Absolute Maximum Ratings

<b>Input Voltage:</b>	
Q12/D24 Models	44 Volts
Q48/D48 Models	88 Volts
<b>Input Reverse-Polarity Protection</b>	Current must be <6A. Brief duration only. Fusing recommended.
<b>Output Overvoltage Protection</b>	
±5V Outputs	6.8 Volts, limited duration
±12V Outputs	15 Volts, limited duration
±15V Outputs	18 Volts, limited duration
<b>Output Current</b>	Current limited. Max. current and short-circuit duration are model dependent.
<b>Storage Temperature</b>	-40 to +105°C
<b>Lead Temperature</b>	See soldering guidelines

These are stress ratings. Exposure of devices to greater than any of these conditions may adversely affect long-term reliability. Proper operation under conditions other than those listed in the Performance/Functional Specifications Table is not implied.

### TECHNICAL NOTES

#### Floating Outputs

Since these are isolated DC/DC converters, their outputs are "floating." Any BMP model may be configured to produce an output of 10V, 24V or 30V (for ±5V, ±12V or ±15V models, respectively) by applying the load across the +Output and -Output (pins 9 and 6), with either output grounded. The Common (pin 8) should be left open. Minimum 20% loading is recommended under these conditions. The total output voltage span may be externally trimmed as described below.

#### Filtering and Noise Reduction

All BMP 25-40 Watt DC/DC Converters achieve their rated ripple and noise specifications without the use of external input/output capacitors. In critical applications, input/output ripple and noise may be further reduced by installing electrolytic capacitors across the input terminals and/or low-ESR tantalum or electrolytic capacitors across the output terminals. Output capacitors should be connected between their respective output pin (pin 6 or 9) and Common (pin 8). See Figure 7. The caps should be located as close to the converters as possible. Typical values are listed in the below. In many applications, using values greater than those listed will yield better results.

#### To Reduce Input Ripple

"Q12, D24" Models	47µF, 50V
"Q48, D48" Models	10µF, 100V

#### To Reduce Output Ripple

±5V Outputs	47µF, 10V, Low ESR
±12/15V Outputs	22µF, 20V, Low ESR

#### Input Fusing

V <sub>IN</sub> Range	Q12	D24	Q48	D48
<b>Fuse Value</b>	4A	4A	3A	2A

**Temperature Derating and Electrical Performance Curves**

**Q12 Models (25 Watts)**

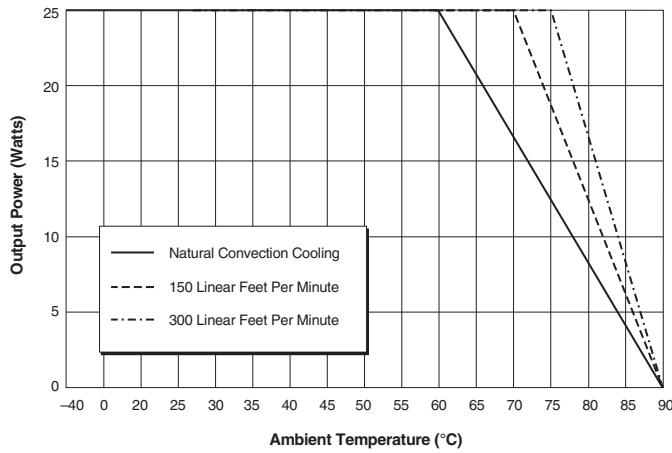

Figure 2a. Temperature Derating Without Heat Sink

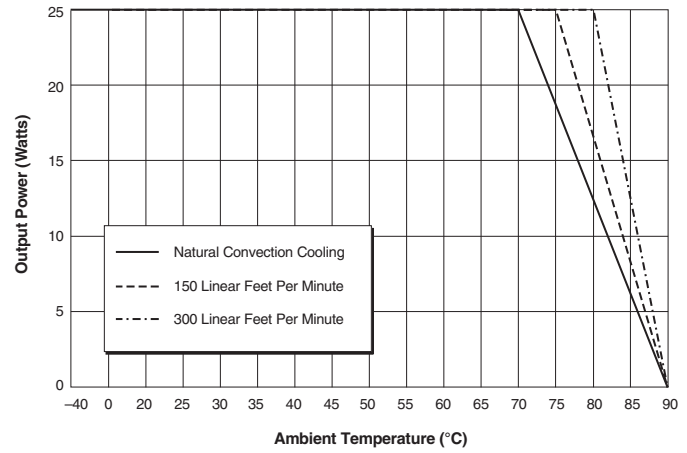

Figure 2b. Temperature Derating With Heat Sink

**Q48 Models (30 Watts)**

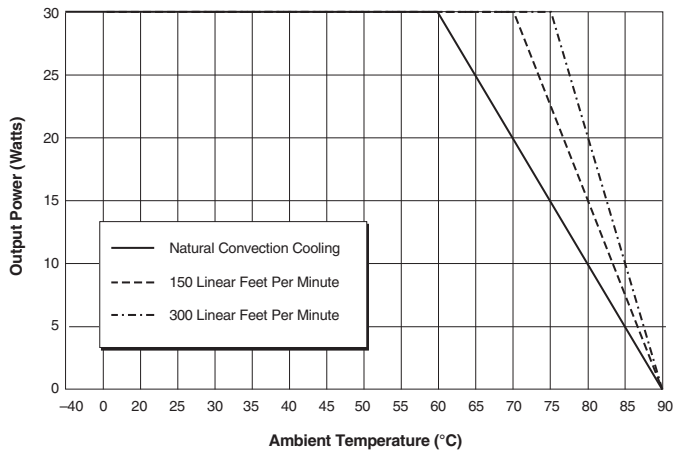

Figure 3a. Temperature Derating Without Heat Sink

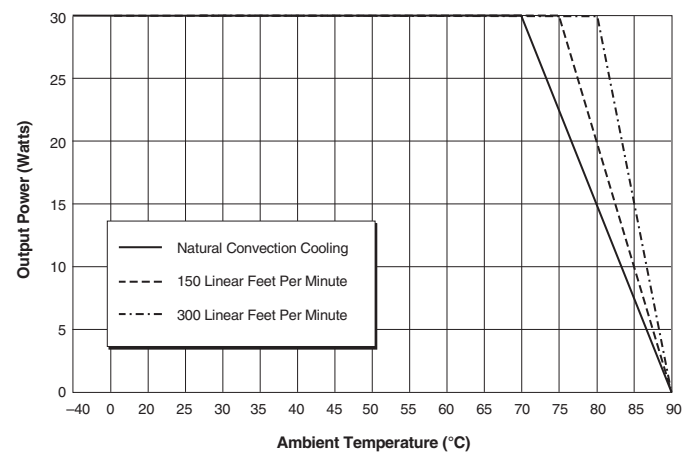

Figure 3b. Temperature Derating With Heat Sink

**D24 Models (35 Watts)**

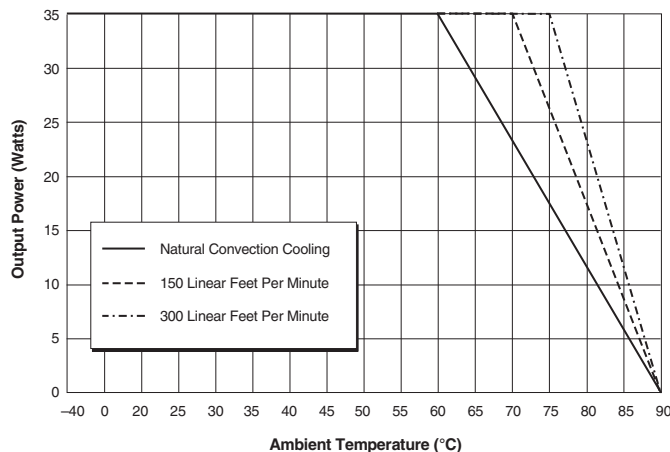

Figure 4a. Temperature Derating Without Heat Sink

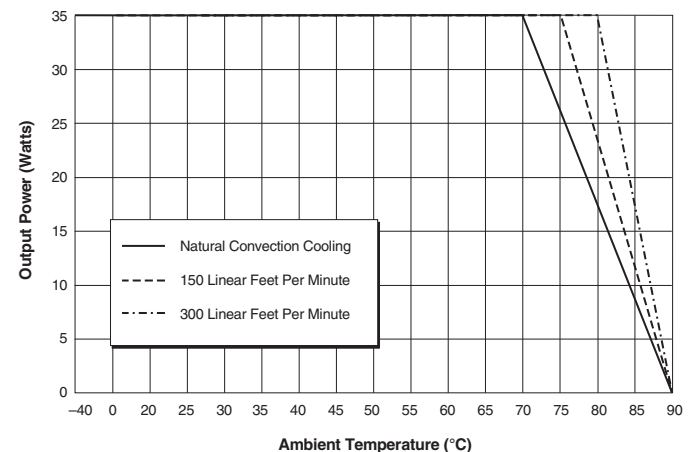
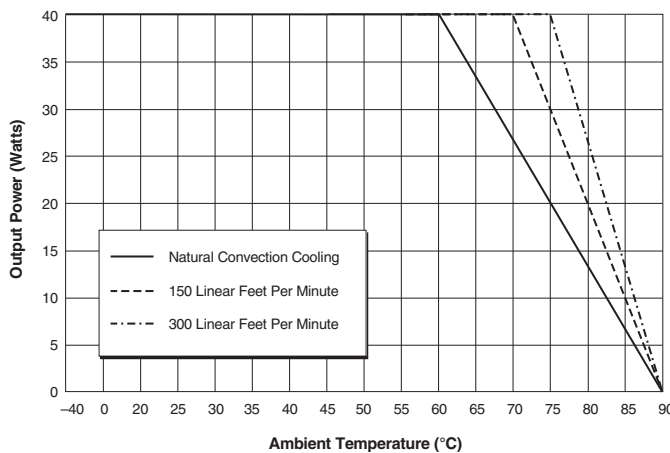

Figure 4b. Temperature Derating With Heat Sink

**Temperature Derating and Electrical Performance Curves**

**D48 Models (40 Watts)**



**Figure 5a. Temperature Derating Without Heat Sink**

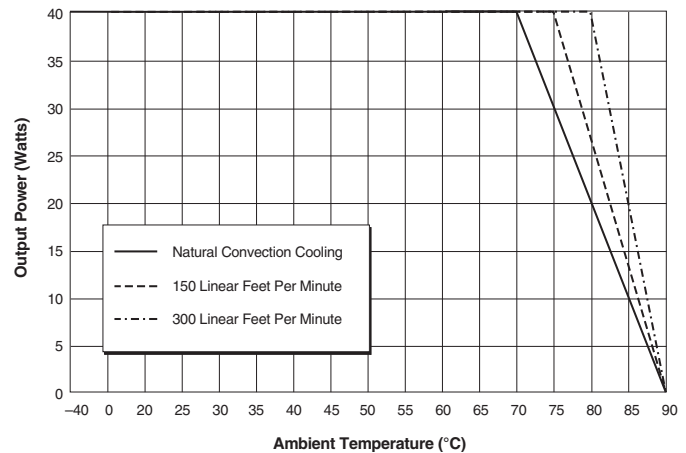

**Figure 5b. Temperature Derating With Heat Sink**

**Output Power**

BMP Model, dual-output DC/DC converters incorporate a design tradeoff between total available output power and input voltage range. The total available power is a function of both the nominal input voltage and the "width" of the input voltage range. For a given nominal input (24V or 48V), narrower ranges (2:1 vs. 4:1) have more available power. For a given "width" of input range (2:1 or 4:1), higher nominal inputs (48V vs. 24V) have more available power. Each device, as indicated by its part-number suffix (Q12, Q48, D24 or D48) has a total output power limitation of 25, 30, 35 or 40 Watts, respectively. Observing these power limitations is the user's responsibility.

As indicated by its Part Number Structure, each  $\pm 5V$ ,  $\pm 12V$  or  $\pm 15V$  BMP device is capable of sourcing up to  $\pm 4$ ,  $\pm 1.65$  or  $\pm 1.3$  Amps, respectively. Users have the flexibility of loading either output up to these limits; however you must be extremely careful not to exceed the total output power rating of any given device. If, for example, a  $\pm 5V$  device with a 30W power rating (BMP-5/4-Q48) is sourcing 4A from its +5V output (representing 20W of

+Output power), that device can only supply an additional 10W (2 Amps) from its -Output.

As a consequence of this "power-allocation" flexibility, the definition of "full load," as the condition under which performance specifications are tested and listed, is ambiguous. The following table lists the positive and negative output currents that DATEL uses to define each device's "full load."

**Threaded Inserts and Heatsink Installation**

**CAUTION:** Do not use the threaded inserts to bolt the converter down to a PC board. That will place unnecessary force on the mounting pins. Instead, the converter is held securely by only soldering the mounting pins.

When attaching the heat sink from above the converter, use a maximum torque of **2 inch-pounds (0.23 N-m)** on the 4-40 bolts to avoid damaging the threaded inserts. Use a tiny amount of fastener adhesive or 4-40 lockwashers to secure the bolts.

**Soldering Guidelines**

Murata Power Solutions recommends the specifications below when installing these converters. These specifications vary depending on the solder type. Exceeding these specifications may cause damage to the product. Be cautious when there is high atmospheric humidity. We strongly recommend a mild pre-bake (100° C. for 30 minutes). Your production environment may differ; therefore please thoroughly review these guidelines with your process engineers.

Wave Solder Operations for through-hole mounted products (THMT)			
For Sn/Ag/Cu based solders:		For Sn/Pb based solders:	
Maximum Preheat Temperature	115° C.	Maximum Preheat Temperature	105° C.
Maximum Pot Temperature	270° C.	Maximum Pot Temperature	250° C.
Maximum Solder Dwell Time	7 seconds	Maximum Solder Dwell Time	6 seconds

Model Number	Voltage Range	Output Power	Definition of "Full Load" for Specification Purposes		
			±5V Currents	±12V Currents	±15V Currents
BMP-5/4-Q12	10-36V	25 Watts	±2.5A (25W)	-	-
BMP-5/4-Q48	18-75V	30 Watts	±3A (30W)	-	-
BMP-5/4-D24	18-36V	35 Watts	±3.5A (35W)	-	-
BMP-5/4-D48	36-75V	40 Watts	±4A (40W)	-	-
BMP-12/1.65-Q12	10-36V	25 Watts	-	±1.04A (24.96W)	-
BMP-12/1.65-Q48	18-75V	30 Watts	-	±1.25A (30W)	-
BMP-12/1.65-D24	18-36V	35 Watts	-	±1.46A (35W)	-
BMP-12/1.65-D48	36-75V	40 Watts	-	±1.67A (40.1W)	-
BMP-15/1.3-Q12	10-36V	25 Watts	-	-	±833mA (24.99W)
BMP-15/1.3-Q48	18-75V	30 Watts	-	-	±1A (30W)
BMP-15/1.3-D24	18-36V	35 Watts	-	-	±1.17A (35.1W)
BMP-15/1.3-D48	36-75V	40 Watts	-	-	±1.33A (39.9W)

Table 1. Output Currents Comprising "Full Load"

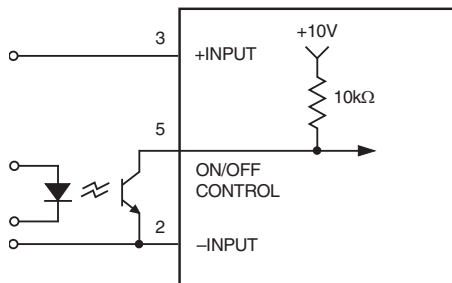

Figure 6. Driving the On/Off Control Pin

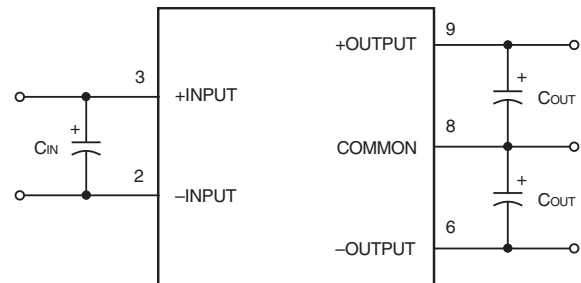

Figure 7. Using External Capacitors to Reduce Input/Output Ripple/Noise

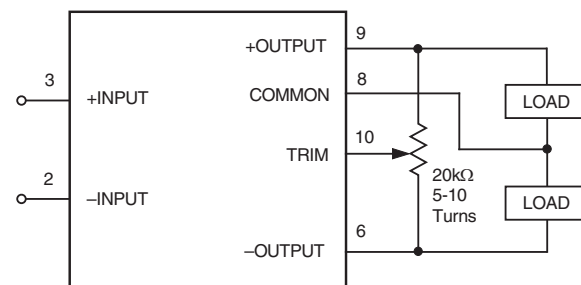

Figure 8. Trim Connections Using a Trimpot