



Technical Data Sheet

7383USRW/S1089-2

Features

- Popular T-1 3/4package.
- High efficiency.
- General purpose leads.
- Selected minimum intensities.
- Available on tape and reel.
- Pb free.

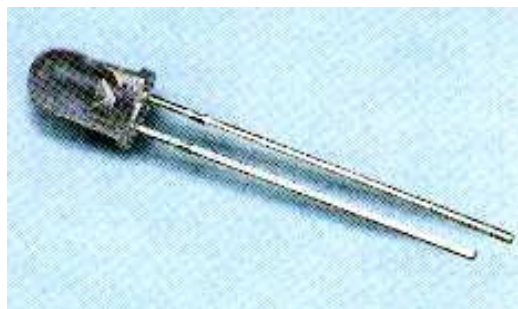

Descriptions

- The series is specially designed for applications requiring higher brightness.
- The LED lamps are available with different colors, intensities, epoxy colors, etc.

Applications

- Optical mouse.
- Computer.

CONFIDENTIAL

Device Selection Guide

LED Part No.	Chip		Lens Color
	Material	Emitted Color	
7383USRW/S1089-2	AlGaInP	Super red	Whiter Diffused

Package Dimensions

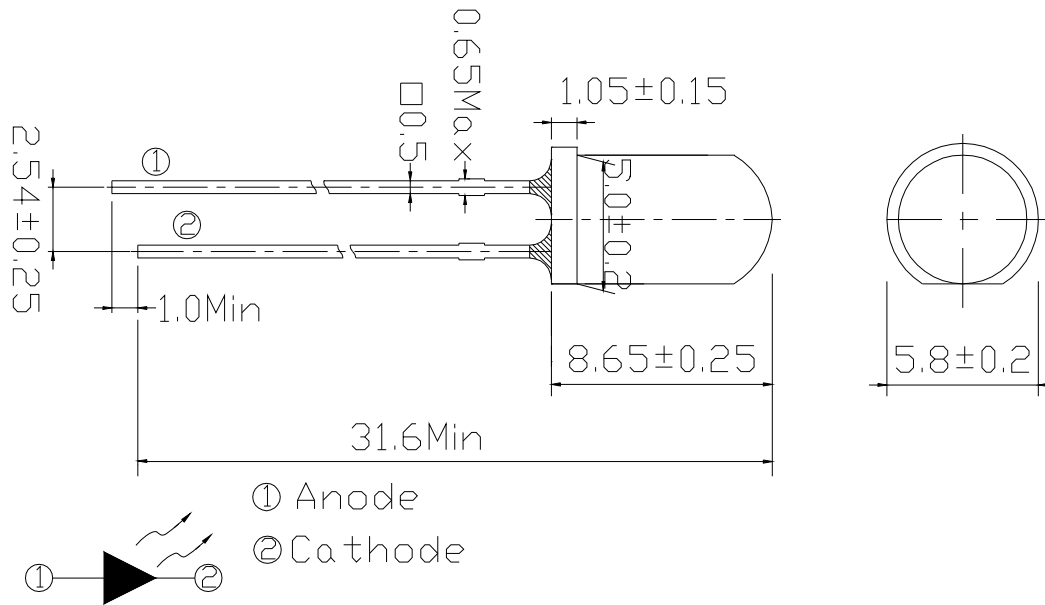

Notes:

- Other dimensions are in millimeters, tolerance is 0.25mm except being specified.
- Protruded resin under flange is 1.5mm Max LED.
- Bare copper alloy is exposed at tie-bar portion after cutting.

Absolute Maximum Rating (T_a=25 °C)

Parameter	Symbol	Absolute Maximum Rating	Unit
Forward Current	I _F	50	mA
Pulse Forward Current (Duty 1/10 @ 1KHz)	I _{FP}	100	mA
Operating Temperature	T _{opr}	-40 ~ +85	
Storage Temperature	T _{stg}	-40 ~ +100	
Electrostatic Discharge	ESD	2000	V
Soldering Temperature	T _{sol}	260 ±5	
Power Dissipation	P _d	130	mW
Reverse Voltage	V _R	5	V

Notes: Soldering time 5 seconds.



Technical Data Sheet

7383USRW/S1089-2

Electro-Optical Characteristics (T_a=25 °C)

Parameter	Symbol	Min.	Typ.	Max.	Unit	Condition
Radiometric Intensity	I _e	8.5	--	17.6	mW/sr	I _F =20mA
Viewing Angle	2θ _{1/2}	--	30	--	deg	
Peak Wavelength	λ _p	--	639	--	nm	
Dominant Wavelength	λ _d	--	628	--		
Spectrum Half width		--	20	--		
Forward Voltage	V _F	1.7	2.0	2.6	V	
Reverse Current	I _R	--	--	10	μA	V _R =5V

Bin Grading for Radiant Intensity: (unit: mW/sr)

Rank	Min.	Max.
K	8.5	10.2
L	10.2	12.2
M	12.2	14.7
N	14.7	17.6

Tolerance for each rank will be ±15%(test I_F=20mA)



Technical Data Sheet

7383USRW/S1089-2

Typical Electro-Optical Characteristics Curves

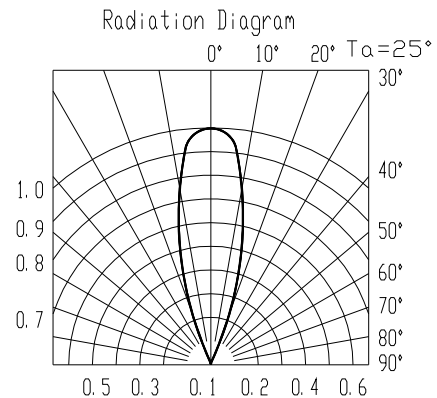
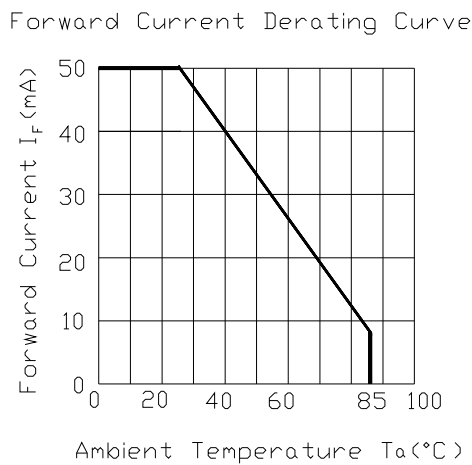
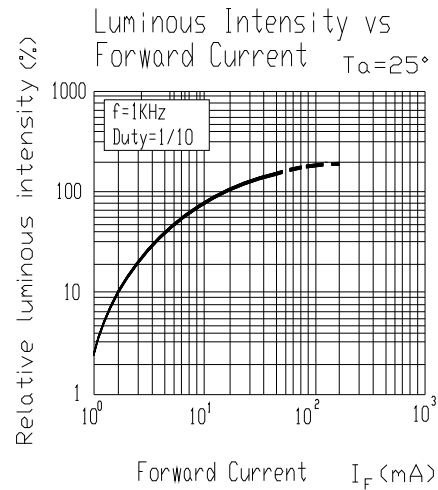
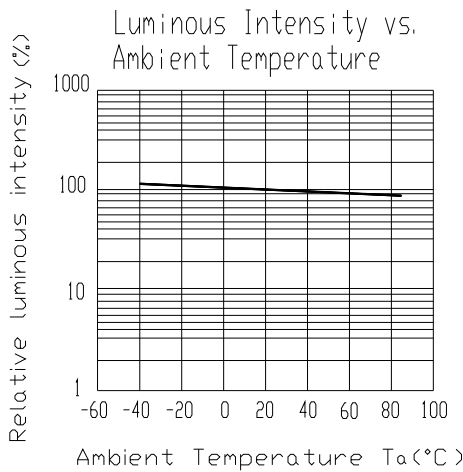
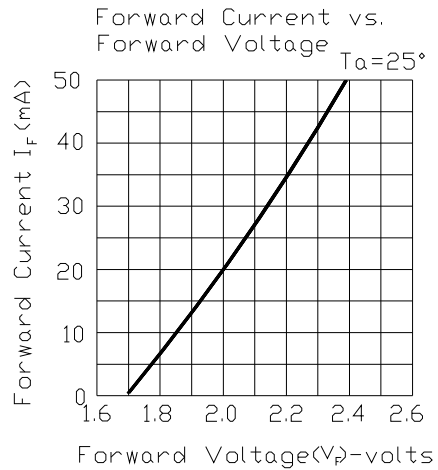
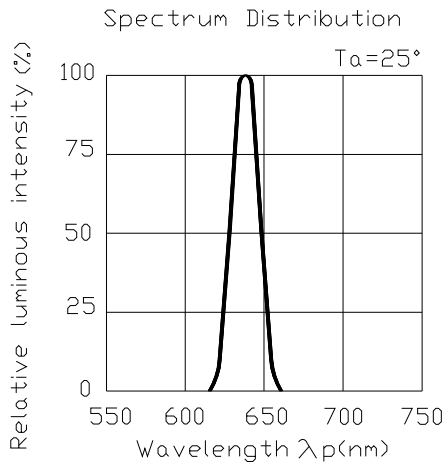



Technical Data Sheet

7383USRW/S1089-2

The reliability of products shall be satisfied with items listed below.

Confidence level : 90%

LTPD : 10%

NO.	Item	Test Conditions	Test Hours/ Cycles	Sample Sizes	Failure Judgment Criteria	Ac/Re
1	Solder Heat	TEMP. : 260 ±5	10secs	22pcs	I _R U×2 I _V L×0.5 V _F U×1.2 U : Upper Specification Limit L : Lower Specification Limit	0/1
2	Temperature Cycle	H : +100 15mins ↑ 5mins ↓ L : -40 15mins	50Cycles	22pcs		0/1
3	Thermal Shock	H : +100 5mins ↑ 10secs ↓ L : -10 5mins	50Cycles	22pcs		0/1
4	High Temperature Storage	TEMP. : +100	1000hrs	22pcs		0/1
5	Low Temperature Storage	TEMP. : -40	1000hrs	22pcs		0/1
6	DC Operating Life	I _F =20mA	1000hrs	22pcs		0/1
7	High Temperature/ High Humidity	85 / 85% R.H	1000hrs	22pcs		0/1

CONFIDENTIAL



Technical Data Sheet



7383USRW/S1089-2

Packing Quantity Specification

1.500PCS/1Bag , 5Bags/1Box

2.10Boxes/1Carton

Label Form Specification

EVERLIGHT	
CPN:	
P/N:	
	
7383USRW/S1089-2	
QTY :	CAT:
	
	HUE:
LOT NO :	REF:
	
MADE IN TAIWAN	

CPN: Customer's Production Number
P/N : Production Number
7383USRW/S1089-2: Production name
QTY: Packing Quantity
CAT: Ranks of Luminous and Forward Voltage
HUE: Ranks of Dominant Wavelength
REF: Reference
LOT No: Lot Number
MADE IN TAIWAN: Production Place

Notes

- Above specification may be changed without notice. EVERLIGHT will reserve authority on material change for above specification.
- When using this product, please observe the absolute maximum ratings and the instructions for using outlined in these specification sheets. EVERLIGHT assumes no responsibility for any damage resulting from use of the product which does not comply with the absolute maximum ratings and the instructions included in these specification sheets.
- These specification sheets include materials protected under copyright of EVERLIGHT corporation. Please don't reproduce or cause anyone to reproduce them without EVERLIGHT's consent.

EVERLIGHT ELECTRONICS CO., LTD.
Office: No 25, Lane 76, Sec 3, Chung Yang Rd,
Tucheng, Taipei 236, Taiwan, R.O.C

Tel: 886-2-2267-2000, 2267-9936
Fax: 886-2267-6244, 2267-6189, 2267-6306
<http://www.everlight.com>