

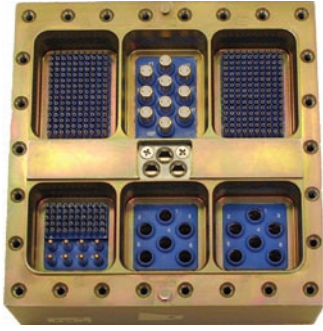

# MIL-DTL-83527



MIL-DTL-83527 connectors are designed to meet or exceed all applicable requirements of the military specification. These connectors come standard with anti-rotational keyed insert assemblies for filter, high-speed fibre channel or Ethernet twinax and quadrx contacts. Offered in a number of different contact arrangements and shell sizes, these connectors are intermateable and interchangeable with the standard non-filtered MIL-DTL-83527 connectors.

## Part Number Description Code

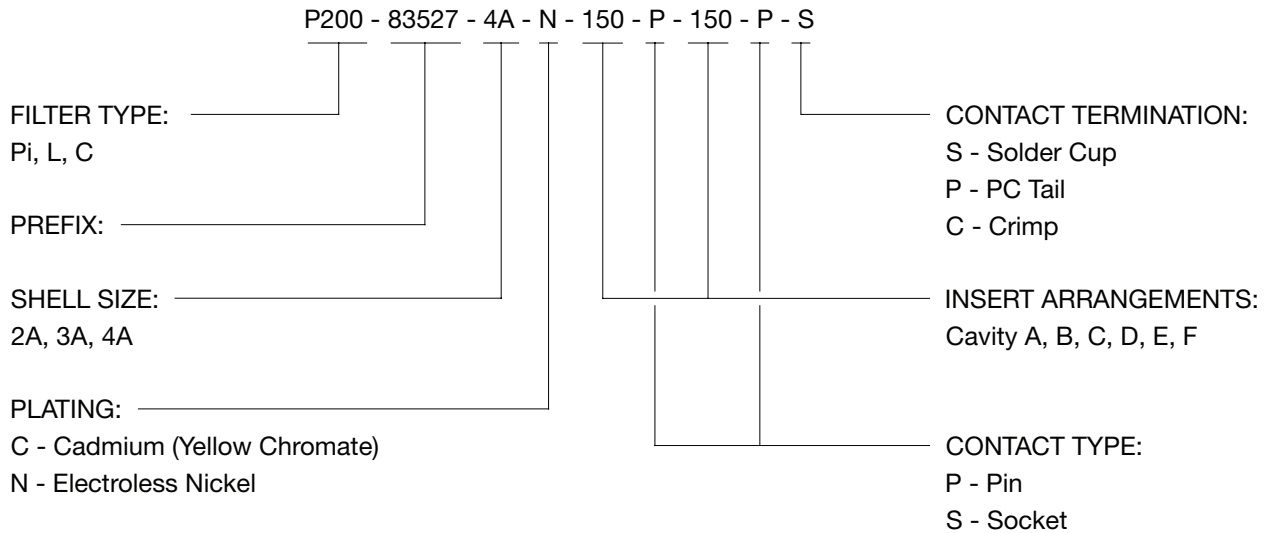

## Insert Arrangements

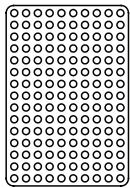

I-150  
150 #22

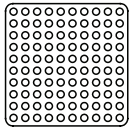

II-100  
100 #22

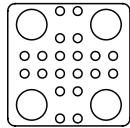

II-20T4  
20 #20  
4 #8 T/C

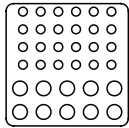

II-34  
24 #20  
10 #16

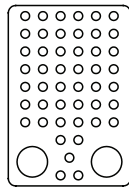

I-47T2  
47 #20  
2 #8 T/C

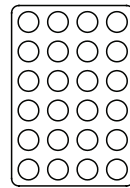

I-24  
24 #12

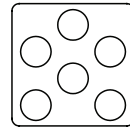

II-T6  
6 #8 T/C

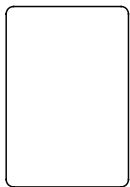

I-0  
BLANK  
CUSTOM

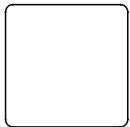

II-0  
BLANK  
CUSTOM

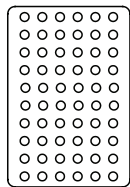

I-60  
60 #20

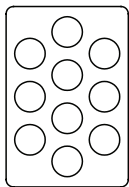

10P10  
10 #8 T/C

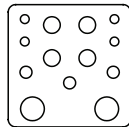

II-11C2  
4 #20  
3 #16  
4 #12  
2 #5

**For Size 8 Contacts Please Specify:**  
T = Twinax/Quadrx Cavity (Anti-Rotational)  
C = Coaxial/Triaxial Cavity

Sabritec provides specialty, enhanced performance connectors and cable assemblies and as such does not currently offer circular, rack and panel, or D-subminiature connectors that are listed on military standard Qualified Products Lists (QPL) per applicable detail specification sheets. Sabritec's connectors are fully intermateable with applicable QPL products and meet the applicable requirements of all military standards listed in this catalog.



# MIL-DTL-83527 Connectors

## Receptacle Shell Sizes 2-4

### Shell Size 2 Receptacle

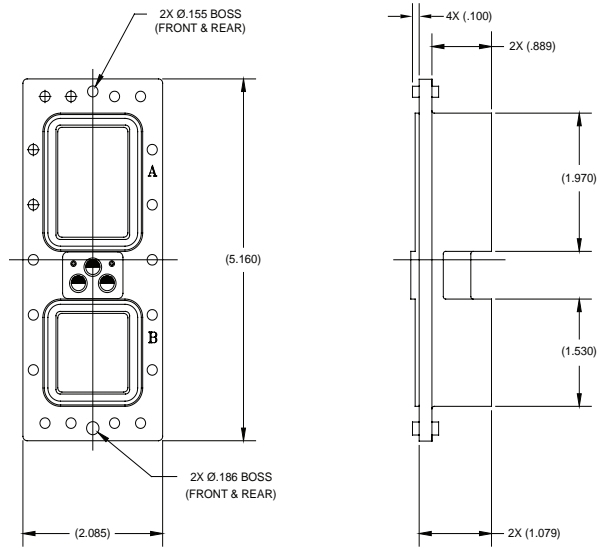

### Shell Size 3 Receptacle

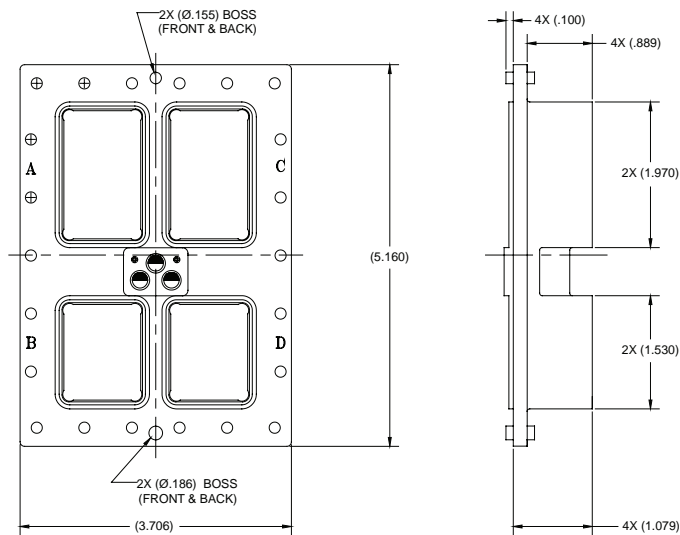

### Shell Size 4 Receptacle

