

FEATURES

- Standard 14 Pin or 8 Pin DIP Footprint
- HCMOS/TTL Compatible
- Fundamental and 3rd Overtone Crystals
- Frequency Range 1.0 – 105.561 MHz
- Frequency Stability, ± 50 ppm Standard (± 25 ppm and ± 20 ppm available)
- +5.0Vdc Operation
- Operating Temperature to -40°C to $+85^{\circ}\text{C}$
- Output Enable Option
- **RoHS/Green Compliant**

DESCRIPTION

The MXO45/MXO45HS is a DIP packaged Clock oscillator offering reliable performance at an economical cost. The enhanced stability means it is the perfect choice for today's communications applications that require tight frequency control.



ORDERING INFORMATION

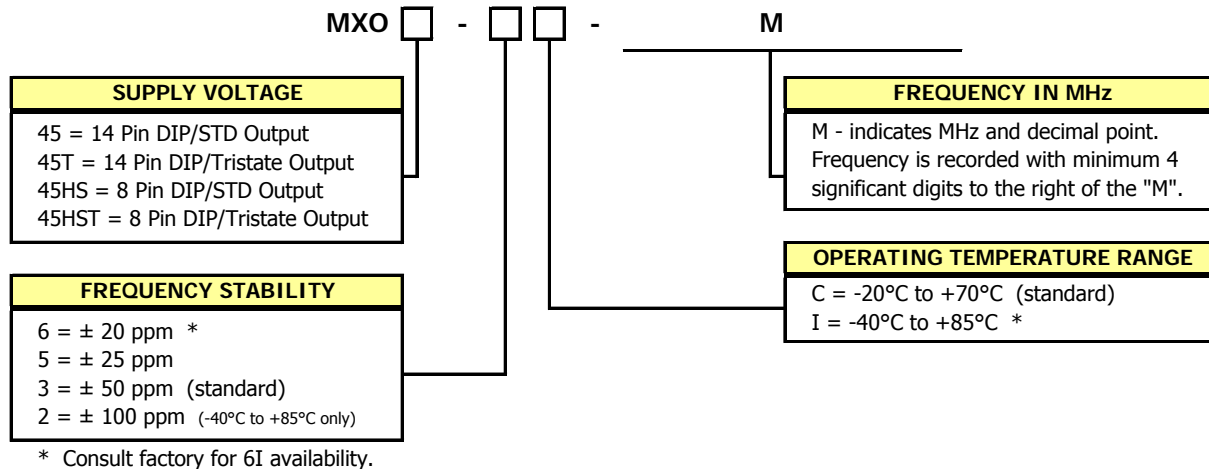

Example Part Number: MXO45-3C-32M7680 or MXO45HS-3C-32M7680

ELECTRICAL CHARACTERISTICS

	PARAMETER	SYMBOL	CONDITIONS	MIN	TYP	MAX	UNIT		
Absolute Maximums	Maximum Supply Voltage	V_{CC}	-	-0.5	-	7.0	V		
	Storage Temperature	T_{STG}	-	-55	-	125	°C		
	Frequency Range	f_o	-	1.0	-	105.561	MHz		
	Frequency Stability (See Note 1 and Ordering Information)	$\Delta f/f_o$	-	-	-	20,25,50 or 100	± ppm		
	Operating Temperature Commercial Industrial	T_A	-	-20 -40	25	70 85	°C		
Electrical and Waveform Parameters	Supply Voltage	V_{CC}	± 10 %	4.5	5.0	5.5	V		
	Supply Current	I_{CC}	1.0 MHz to 20 MHz $C_L=50pF$	-	10	25	mA		
			20.1 MHz to 80 MHz $C_L=30pF$	-	30	50			
			80.1 MHz to 105.561 MHz $C_L=15pF$	-	40	100			
	Output Load CMOS	C_L	1.0 MHz to 50 MHz	-	-	50	pF		
			50.1 MHz to 80 MHz	-	-	30			
	TTL		80.1 MHz to 105.561 MHz	-	-	15	TTL		
			1.0 MHz to 105.561 MHz	-	-	10			
	Output Voltage Levels Logic '1' Level	V_{OH}	CMOS Load	0.9* V_{CC} $V_{CC}-0.6V$	-	-	V		
			10 TTL LOAD						
	Logic '0' Level	V_{OL}	CMOS	-	-	0.1* V_{CC} 0.4	V		
			TTL Load						
	Output Current Logic '1' Level	I_{OH}	$V_{OH} = 3.9V$ $V_{CC} = 4.5V$	-	-	-16	mA		
			Logic '0' Level					I_{OL} $V_{OL} = 0.4V$ $V_{CC} = 4.5V$	
	Output Duty Cycle	SYM	@ 50% Level	45	-	55	%		
Rise and Fall Time	T_{Rr} T_{F}	@ 10% - 90% Levels	-	8	10	ns			
		1.0 MHz to 50 MHz $C_L=50pF$							
		50.1 MHz to 80 MHz $C_L=30pF$							
80.1 MHz to 105.561 MHz $C_L=15pF$	-	2.5	5						
Start Up Time	T_S	Application of V_{CC}	-	-	10	ms			
Enable Function (See Note 2)	V_{IH}	Pin 1 Logic '1', Output Enabled	2.0	-	-	V			
		Disable Input Voltage					V_{IL}	-	0.8
		Enable Time					T_{PLZ}	-	-
Phase Jitter	t_{jms}	Bandwidth 12 kHz - 20 MHz	-	-	1	ps RMS			

Notes:

1. Inclusive of initial tolerance at time of shipment, changes in supply voltage, load, temperature and first year aging at an average operating temperature of +40 °C.
2. Reference CTS Application Note 014-0002-0.

CMOS/TTL OUTPUT WAVEFORM

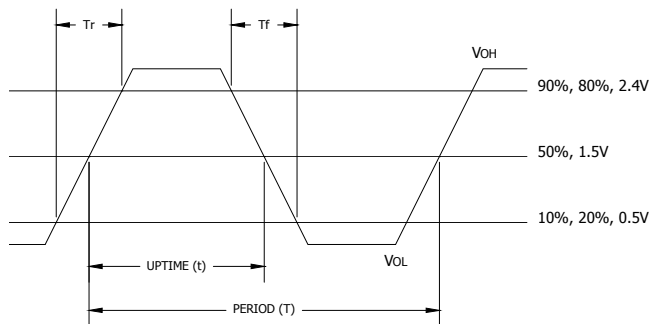

$$\text{DUTY CYCLE} = t/T \times 100 (\%)$$

ENABLE TRUTH TABLE

PIN 1	PIN 5 or PIN 8
Logic '1'	Output
Open	Output
Logic '0'	High Imp.

TEST CIRCUIT, CMOS LOAD

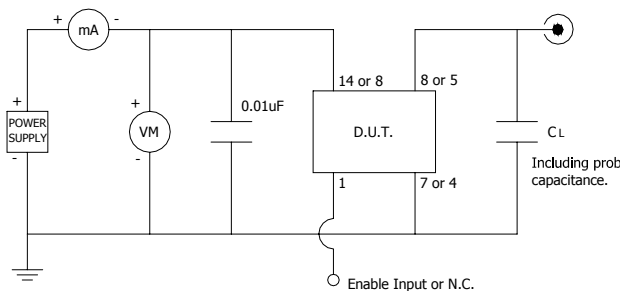

D.U.T. PIN ASSIGNMENTS

PIN	SYMBOL	DESCRIPTION
1	EOH	Enable Input
7 or 4	GND	Circuit & Package Ground
8 or 5	Output	RF Output
14 or 8	V_{CC}	Supply Voltage

MECHANICAL SPECIFICATIONS

PACKAGE DRAWING

DIP-14

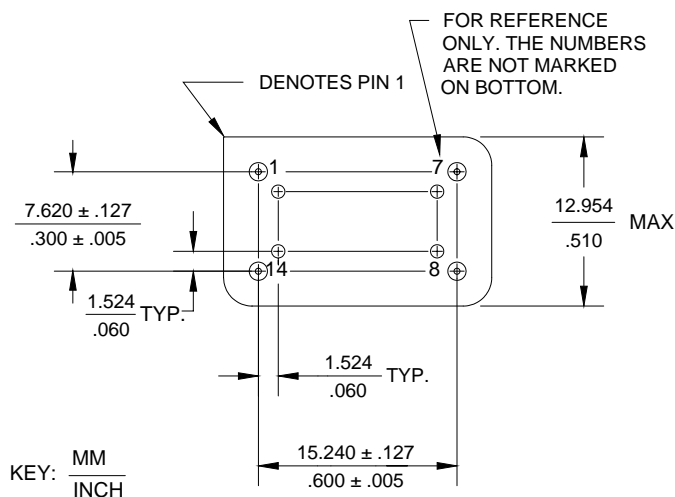
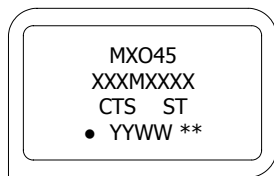
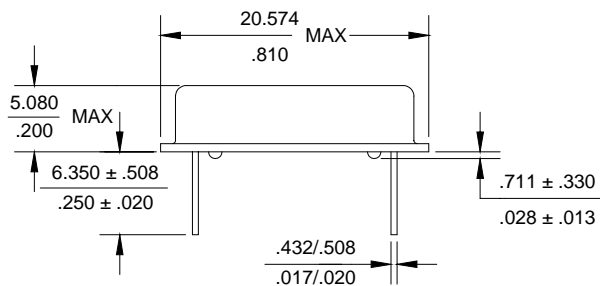

MARKING INFORMATION

1. XXXMXXXX - Frequency marked with 4 significant digits after the 'M'.
2. ST - Frequency stability/temperature code. (Reference Ordering Information.)
3. YYWW - Date code, YY - year, WW - week.
4. ** - Manufacturing Site Code.

NOTES

1. Lead finish (e1), SnAgCu.
2. Reflow conditions per JEDEC J-STD-020.

PACKAGE DRAWING

DIP-8

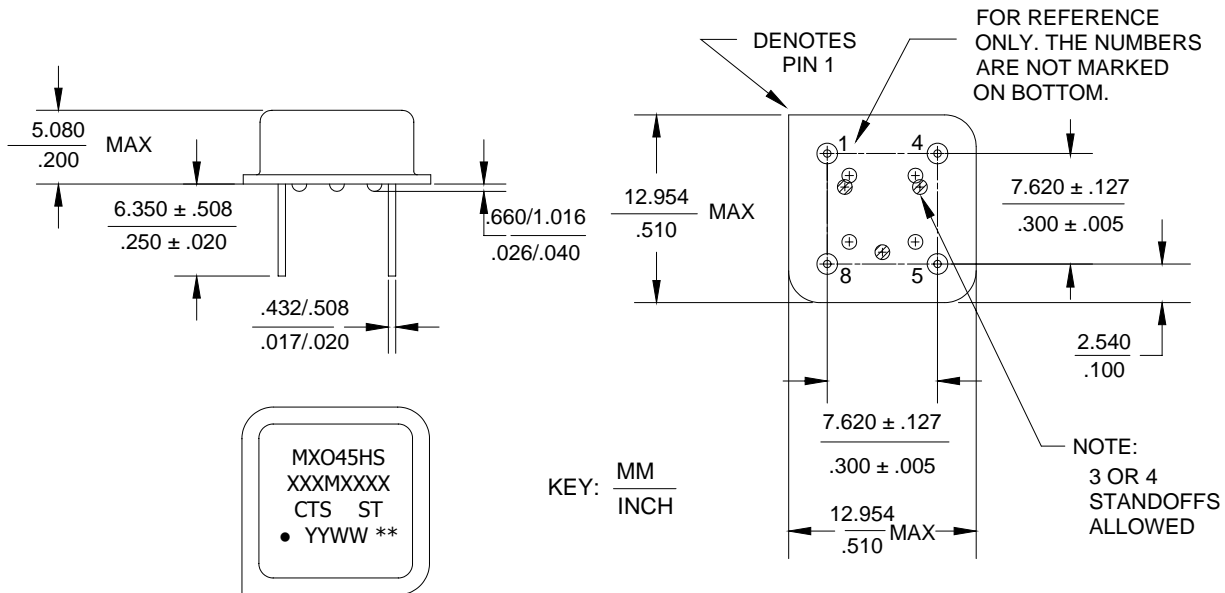

MARKING INFORMATION

1. XXXMXXXX - Frequency marked with 4 significant digits after the 'M'.
2. ST - Frequency stability/temperature code. (Reference Ordering Information.)
3. YYWW - Date code, YY - year, WW - week.
4. ** - Manufacturing Site Code.

NOTES

1. Lead finish (e1), SnAgCu.
2. Reflow conditions per JEDEC J-STD-020.

ENVIRONMENTAL SPECIFICATIONS

Temperature Cycle:	400 cycles from -55°C to +125°C, 10 minute dwell at each temperature, 1 minute transfer time between temperatures.
Mechanical Shock:	1,500g's, 0.5mS duration, ½ sinewave, 3 shocks each direction along 3 mutually perpendicular planes (18 total shocks).
Sinusoidal Vibration:	0.06 inches double amplitude, 10 to 55 Hz and 20g's, 55 to 2,000 Hz, 3 cycles each in 3 mutually perpendicular planes (9 times total).
Gross Leak:	No leak shall appear while immersed in an FC40 or equivalent liquid at +125°C for 20 seconds.
Fine Leak:	Mass spectrometer leak rates less than 2×10^{-8} ATM cc/sec air equivalent.
Resistance to Solder Heat:	Product must survive 3 reflows of +260°C peak, 10 seconds maximum.
High Temperature Operating Bias:	2,000 hours at +125°C, maximum bias, disregarding frequency shift.
Frequency Aging:	1,000 hours at +85°C, full bias, less than ±5 ppm shift.
Moisture Sensitivity Level:	Level 1 per JEDEC J-STD-020.

QUALITY AND RELIABILITY

Quality systems meet or exceed the requirements of ISO 9000:2000 standards.