

155Mbps 1X9 SC Duplex Single Mode Laser Transceiver for ATM, SONET OC-3/SDH STM-1

155B2J1

Feature

- Industry Standard 1 x 9 Footprint
- Compliant with existing standards
- Single +3.3 V Power Supply
- PECL Differential Inputs and Outputs
- Wave Solderable and Aqueous Washable
- Class 1 Laser International Safety Standard IEC 825 Compliant
- OPT-155B2J1 for 15km Links;

Applications

- ATM 155Mb/s Links
- SONET/SDH Equipment Interconnect
- WDM Application

Absolute Maximum Ratings

Parameter	Symbol	Min.	Typ.	Max.	Unit	Reference
Storage temperature	T _s	-60		85	°C	
Lead soldering temperature	T _{SOLD}			260	°C	
Lead soldering time	t _{SOLD}			10	sec.	
Supply voltage	V _{CC}	0		5	V	

Recommended Operating Conditions:

Parameter	Symbol	Min.	Typ.	Max.	Unit	Reference
Ambient Operating Temperature	T _A	0		70	°C	
Supply voltage	V _{CC}	3.135	3.3	3.465	V	
Transmitter Data input voltage-Low	V _{IL} - V _{CC}	-1.810		-1.475	V	
Transmitter Data input voltage-High	V _{IH} - V _{CC}	-1.165		-0.880	V	
Data Output Load	R _{DL}		50		Ω	

 DELTA ELECTRONICS, INC.	TITLE				DATE:
	OPT-155B2J1				Jan.31.2002
	WRITTEN	CHECKED	APPROVED	DOCUMENT NO:	REV:
Yuhong	Teddy Kuo	Y.Y Tsai		S1	

155Mbps 1X9 SC Duplex Single Mode Laser Transceiver for ATM, SONET OC-3/SDH STM-1

155B2J1

Transmitter Electro-Optical Performance Specifications:

Parameter	Symbol	Min.	Typ.	Max.	Unit	Reference
Supply current	I _{cc}			140	mA	
Launched power(avg.)	P _O	-15		-8	dBm	Note(1)
Optical extinction ratio		10			dB	Note(1)
Center wavelength	λ_c	1274	1310	1355	nm	
Spectral width(RMS)	σ			3	nm rms	
Optical risetime	t _r			1.3	ns	Note(2)
Optical falltime	t _f			1.3	ns	Note(2)
Output Eye	Compliant with Bellcore TR-NWT-000253 and ITU recommendation G.957					

Note(1).Launched power is power coupled into a single mode fiber.

Note(2).These are 10-90% values.

Receiver Electro-Optical Performance Specifications:

Parameter	Symbol	Min.	Typ.	Max.	Unit	Reference
Supply current	I _{cc}			130	mA	
Data output voltage-Low	V _{OL} - V _{CC}	-1.950		-1.620	V _{CC}	
Data output voltage-High	V _{OH} - V _{CC}	-1.045		-0.740	V _{CC}	
Optical input sensitivity(avg.)	P _{IN}			-32	dBm	Note(1)
Optical input saturation(avg.)	P _{SAT}	-7.5			dBm	Note(1)
Optical wavelength	λ		1310		nm	
Signal detect-Assert	P _A			-33	dBm	
Signal detect-Deassert	P _D	-48			dBm	
Signal detect-Hysteresis	P _A -P _D	0.5			dB	

Note(1).With BER better than or equal to 1×10^{-12} , measured in the center of the eye opening with $2^{23}-1$ NRZ PRBS

 DELTA ELECTRONICS, INC.	TITLE				DATE:
	OPT-155B2J1				Jan.31.2002
	WRITTEN	CHECKED	APPROVED	DOCUMENT NO:	REV:
Yuhong	Teddy Kuo	Y.Y Tsai		S1	

155Mbps 1X9 SC Duplex Single Mode Laser Transceiver for ATM, SONET OC-3/SDH STM-1

155B2J1

Recommended Circuit Schematic

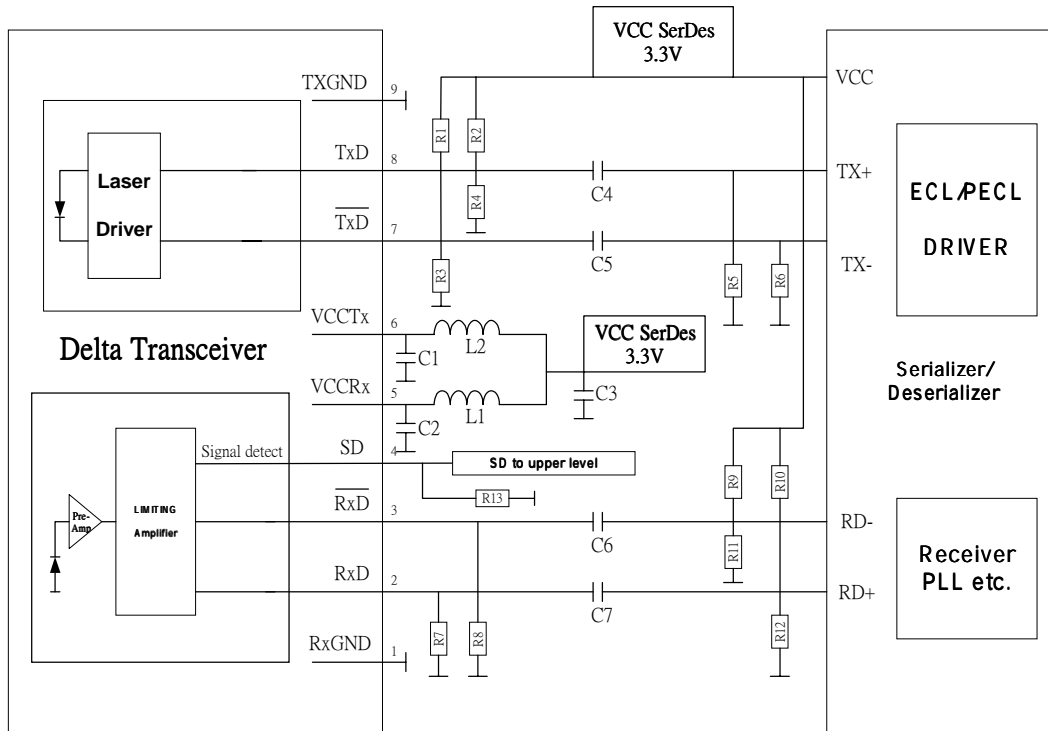

C1/2/3 = 4.7 μ F

C4/5/6/7 = 10 nF

L1/2 = 1 μ H

R1/2 = 82 Ω

R3/4 = 130 Ω

R7/8 = 150 Ω

R5/6/9/10/11/12 Depend on SerDes chip used .

R13 = 270 Ω (For PECL output).

R13 = Open (For TTL output).

Values of R5/6/9/10/11/12 may vary as long as proper 50 Ω termination to VEE or 100 Ω differential is provided. For good EMI performance, the power supply filter is required. Use short tracks from the inductor L1/L2 to the module VccTx/VccRx.

	TITLE			DATE:	
	OPT-155B2J1			Jan.31.2002	
	WRITTEN	CHECKED	APPROVED	DOCUMENT NO:	REV:
Yuhong	Teddy Kuo	Y.Y Tsai		S1	

155Mbps 1X9 SC Duplex Single Mode Laser Transceiver for ATM, SONET OC-3/SDH STM-1

155B2J1

Mechanical Dimensions

Unit : mm

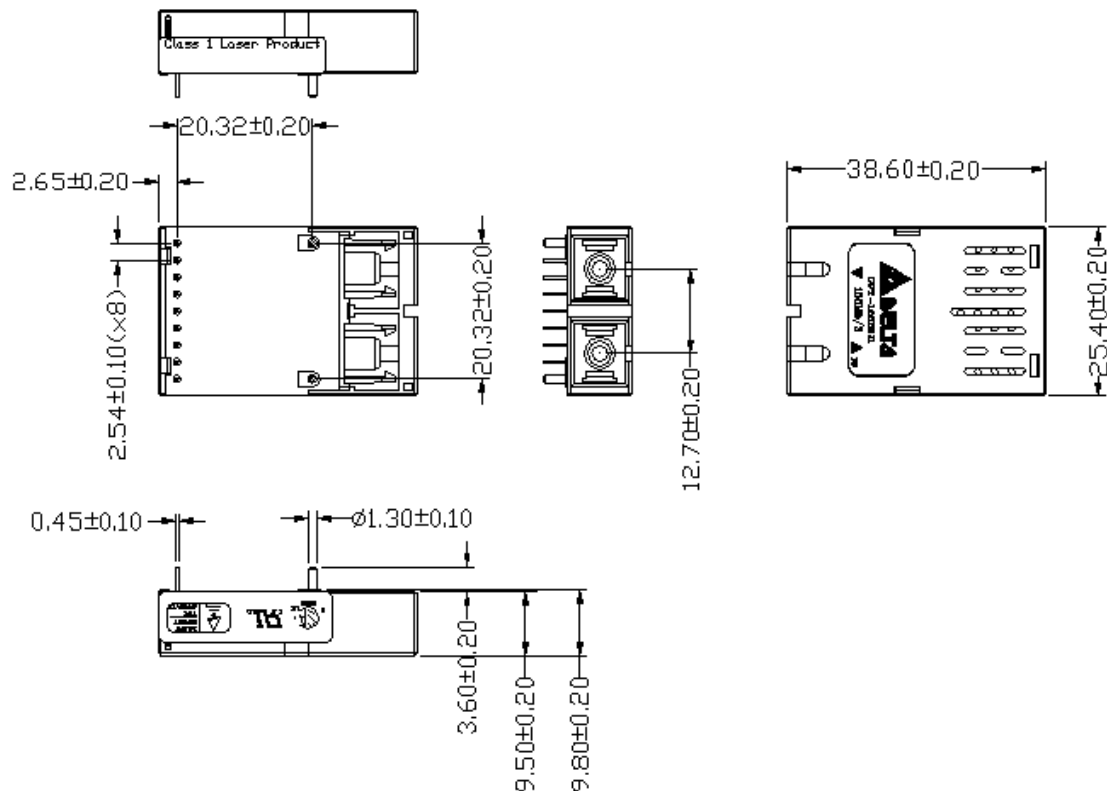

LASER SAFETY

This single mode transceiver is a Class 1 laser product. It complies with IEC 825 and FDA 21 CFR 1040.10 and 1040.11. The transceiver must be operated within the specified temperature and voltage limits. The optical ports of the module shall be terminated with an optical connector or with a dust plug.

 DELTA ELECTRONICS, INC.	TITLE			DATE:
	OPT-155B2J1			Jan.31.2002
	WRITTEN	CHECKED	APPROVED	DOCUMENT NO:
Yuhong	Teddy Kuo	Y.Y Tsai		S1

155Mbps 1X9 SC Duplex Single Mode Laser Transceiver for ATM, SONET OC-3/SDH STM-1

155B2J1

Regulatory Compliance

Test Item	Reference	Qty'	Evaluation
(#1) Electromagnetic Interference EMI	FCC Class B	5	(1) Satisfied with electrical characteristics of product spec. (2) No physical damage
	EN 55022 Class B		
	CISPR 22		
(#2) Immunity : Radio Frequency Electromagnetic Field	EN 61000-4-3	5	
	IEC 1000-4-3		
(#3) Immunity : Electrostatic Discharge to the Duplex SC Receptacle	EN 61000-4-2	5	
	IEC 1000-4-2		
	IEC 801.2		
(#4) Electrostatic Discharge to the Electrical Pins	MIL-STD-883C Method 3015.4	5	
	EIAJ#1988.3.2B Version 2, Machine model		

 DELTA ELECTRONICS, INC.	TITLE			DATE:
	OPT-155B2J1			Jan.31.2002
	WRITTEN	CHECKED	APPROVED	DOCUMENT NO:
Yuhong	Teddy Kuo	Y.Y Tsai		S1