

# Shuen 1W Series

# 炫

*“Shuen [Xuan] is the English translation for the Chinese word meaning Bright and Shiny. Both words are relevant descriptions of this Everlight LED series. The modern, adaptive Chinese definition of the word represents that which is New, Extravagant, and Highly Sought After.”*

## Introduction

The Shuen series is a surface-mount high-power device featuring high brightness combined with a compact size that is suitable for all kinds of lighting applications such as general illumination, flash, spot, signal, industrial and commercial lighting. The thermal pad of this device is electrically isolated providing convenience in thermal and electrical design. The Shuen series is one of the most promising devices in Everlight's high power product offering and is ready to face the challenges of today's Solid-State Lighting requirements.

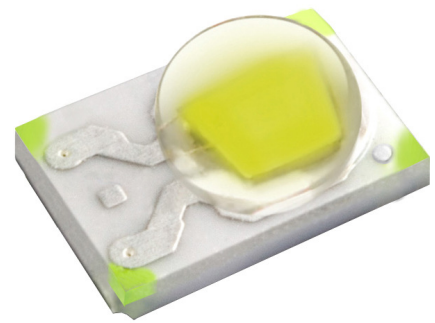

## Features

- ◆ Small package with high efficiency
- ◆ ESD protection up to 8KV
- ◆ Soldering method: SMT
- ◆ Binning Parameters: Brightness, Forward Voltage, Wavelength and Chromaticity
- ◆ Moisture Sensitivity Level: 1
- ◆ RoHS compliant
- ◆ Matches ANSI binning
- ◆ Reliability testing conforms to IESNA LM80 Lumen maintenance test method

## Applications

- ◆ General Lighting
- ◆ Decorative and Entertainment Lighting
- ◆ Signal and Symbol
- ◆ Exterior and Interior Automotive Illumination

## Table of Contents

Product Nomenclature .....	3
Absolute Maximum Ratings .....	4
JEDEC Moisture Sensitivity .....	4
Luminous Flux Characteristics for the Shuen series .....	5
PN of the Shuen series: White LEDs .....	6
PN of the Shuen series: Color LEDs .....	7
Product Binning .....	9
White Bin Structure .....	10
Forward Voltage Bins .....	14
Color Bins .....	15
Optical Characteristics .....	16
Mechanical Dimension .....	17
Pad Configuration .....	18
Reflow Soldering Characteristics .....	19
Wavelength Characteristics .....	20
Typical Light Output Characteristic vs. Thermal Pad Temperature .....	22
Typical Electrical Characteristics .....	23
Typical Relative Luminous Flux vs. Forward Current .....	24
Typical Wavelength & CCT Shift Characteristics vs. Forward Current .....	26
Current Derating Curves .....	28
Typical Radiation Patterns .....	29
Emitter Tape Packaging .....	31
Emitter Reel Packaging .....	32
Product Labeling .....	32
Revision History .....	33

## Product Nomenclature

The product name is designated as below:

# ELSH – ABCDE – FGHIJ – V1234

Designation:

AB = min. luminous flux (lm) or radiation power (mW) performance

C = radiation pattern <sup>[1]</sup>

D = color <sup>[2]</sup>

E = power consumption <sup>[3]</sup>

F = reserved for future product offerings

G = internal coding

H = packaging type <sup>[4]</sup>

IJ = internal coding

V = forward voltage bin

1234 = color bin or CCT bin

### Notes

1. Table of radiation patterns

Symbol	Description
1	Lambertian

2. Table of color offerings:

Symbol	Color	Dominant wavelength range
R	Red	620~635nm
O	Orange	610~620nm
Y	Amber	580~595nm
G	Green	520~550nm
B	Blue	450~470nm
L	Royal Blue	445~460nm
C	Cool-White	4745~7050K
N	Neutral-White	3710~4745K
M	Warm-White	2580~3710K
E	Deep-Red	645~675nm
F	Far-Red	715~745nm

3. Table of power consumptions:

Symbol	Description
1	1W

4. Table of packaging types:

Symbol	Description
P	Tape
B	Tube

## Absolute Maximum Ratings

Parameter	Symbol	Ratings	Unit
Max. DC Forward Current (mA)	$I_F$	400 <sup>[1]</sup>	mA
Max. Peak Pulse Current (mA)	$I_{Pulse}$	1000	mA
Max. ESD Resistance	$V_B$	8000	V
Reverse Voltage	$V_R$	Note 2	V
Thermal Resistance	$R_{th}$	10~12 <sup>[3]</sup>	°C/W
Max. Junction Temperature	$T_J$	125 <sup>[4]</sup>	°C
Operating Temperature	$T_{Opr}$	-40 ~ +100 <sup>[5]</sup>	°C
Storage Temperature	$T_{Stg}$	-40 ~ +100	°C
Max. Soldering Temperature	$T_{Sol}$	260	°C
Allowable Reflow Cycles	n/a	2	cycles

### Notes:

- Maximum forward current for 1W is 400mA ( $T_{Thermal\ Pad}=25^{\circ}C$ ).
- The Shuen series LEDs are not designed for reverse bias used.
- Thermal Resistance is 10°C/W for Blue, Green, Cool-White, Neutral-White, and Warm-White LEDs and 12°C/W for Red, Amber, and Yellow LEDs.
- Maximum junction temperature of Cool-White, Neutral-White, Warm-White, Blue, Cyan, Green, Deep-Red, Red, Amber, and Yellow LEDs is 125°C.
- Maximum Operating Temperature (Thermal Pad) of Cool-White, Neutral-White, Warm-White, Blue, Cyan, Green, Deep-Red, Red, Amber, and Yellow LEDs is 100°C.
- Avoid operating Shuen LEDs at maximum operating temperature exceeding 1 hour.

## JEDEC Moisture Sensitivity

Level	Floor Life		Soak Requirements Standard	
	Time (hours)	Conditions	Time (hours)	Conditions
	1	unlimited	$\leq 30^{\circ}C / 85\% RH$	168 (+5/-0)

## Luminous Flux Characteristics for the Shuen series

Color	Part Number	1W	
		Minimum Luminous Flux(lm) or Radiometric Power(mW) <sup>[1]</sup>	Drive Current (mA)
Cool White	ELSH – F81CX	80	350
	ELSH – F91CX	90	350
	*ELSH – J11CX	100	350
Neutral White	ELSH – F71NX	70	350
	ELSH – F81NX	80	350
	*ELSH – F91NX	90	350
Warm White	ELSH – F61MX	60	350
	ELSH – F71MX	70	350
	*ELSH – F81MX	80	350
Red	ELSH – F41RX	45	350
	ELSH – F51RX	52	350
	*ELSH – F61RX	60	350
Orange	ELSH – F41OX	45	350
	ELSH – F51OX	52	350
	*ELSH – F61OX	60	350
Amber	ELSH – F31YX	39	350
	ELSH – F41YX	45	350
	*ELSH – F51YX	52	350
Green	ELSH – F71GX	70	350
	*ELSH – F81GX	80	350
Blue	ELSH – E61BX	13	350
	*ELSH – E71BX	17	350
Royal Blue	*ELSH – Q91LX	275	350
Deep Red	ELSH – Q91EX	275	350
	*ELSH – R11EX	350	350
Far Red	ELSH – Q61LX	125	350
	*ELSH – Q71LX	175	350

**Note:**

1. Luminous flux measurement tolerance: ±10%.
2. The data of luminous flux measured at thermal pad=25 °C
3. Typical luminous flux or light output performance is operated within the condition guided by this datasheet.
4. Please contact sales for timing and availability of P/N's marked with an asterisk "\*".
5. The range of Luminous Flux in Royal-Blue, Deep-Red and Far-Red is described as Radiometric Power.

## PN of the Shuen series: White LEDs

The table below is a list of part numbers for the Everlight Shuen 1W series White LED. All parts listed match ANSI binning standards. Bin offerings of 5700K, 6500K, and 3000K are listed and currently available. CRI is also listed with a typical 75 to 90. These clearly listed binning options allow for proper design and implementation into lighting applications. The Order Codes below are currently available White Shuen LEDs.

For Example: If you order product using P/N **ELSH-F81C1-0LPGS-C5700**, you will get

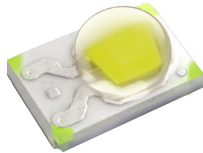

Color Variant	Radiation Pattern	CRI	CCT	Forward Voltage (V)	Minimum Luminous Flux (lm)
Cool White	Lambertian	75	57K-1 ~ 57K-2 ~ 57K-3 ~ 57K-4	2.95~3.25(V1) 3.25~3.55(V2) 3.55~3.85(V3)	80

White, Shuen series LEDs at 350mA are listed below

Color	Order Code of ELSH	Minimum Luminous Flux (lm)	CCT (K) Wavelength (nm)	Forward Voltage (V)	CRI (Typical)[1]
Cool White 6500	*ELSH-F81C1-0LPGS-C6500	80	6500-1~6500-4	2.95~3.85	75
	ELSH-F91C1-0LPGS-C6500	90	6500-1~6500-4	2.95~3.85	75
	*ELSH-J11C1-0LPGS-C6500	100	6500-1~6500-4	2.95~3.85	75
Cool White 5700	*ELSH-F81C1-0LPGS-C5700	80	5700-1~5700-4	2.95~3.85	75
	ELSH-F91C1-0LPGS-C5700	90	5700-1~5700-4	2.95~3.85	75
	*ELSH-J11C1-0LPGS-C5700	100	5700-1~5700-4	2.95~3.85	75
Neutral White 4000	ELSH-F71N1-0LPGS-C4000	70	4000-1~4000-4	2.95~3.85	75
	ELSH-F81N1-0LPGS-C4000	80	4000-1~4000-4	2.95~3.85	75
Warm White 3000	ELSH-F61M1-0LPGS-C3000	60	3000-1~3000-4	2.95~3.85	75
	ELSH-F71M1-0LPGS-C3000	70	3000-1~3000-4	2.95~3.85	75
	*ELSH-F81M1-0LPGS-C3000	80	3000-1~3000-4	2.95~3.85	75

**Note:**

1. CRI measurement tolerance: ±5.
2. Please contact sales for timing and availability of P/N's marked with an asterisk "\*".

## PN of the Shuen series: Color LEDs

The table below is a list of part numbers for the Everlight Shuen series Color LED. Standard Everlight color bins are listed according to wavelength and represent the standard primary colors of the spectrum. These clearly listed binning options allow for proper design and implementation into lighting applications.

For Example: If you order product using P/N **ELSH-F41R1-0LPNM-AR5R6**, you will get

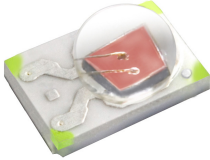

Color Variant	Radiation Pattern	Dominant Wavelength (nm)	Forward Voltage (V)	Minimum Luminous Flux (lm)
Red	Lambertian	620~625(R5) 625~630(R6)	1.75~2.05(U1) 2.05~2.35(U2) 2.35~2.65(U3)	52

Color, Shuen series LEDs at 350mA are listed below.

Color	Order Code of ELSH	Minimum Luminous Flux (lm)	Dominant Wavelength (nm)	Forward Voltage(V)
<b>Red</b>	ELSH-F41R1-0LPNM-AR5R6	45	620~630	1.75~2.95
	ELSH-F51R1-0LPNM-AR5R6	52	620~630	1.75~2.95
	*ELSH-F61R1-0LPNM-AR5R6	60	620~630	1.75~2.95
<b>Orange</b>	ELSH-F41O1-0LPNM-AR3R4	45	610~620	1.75~2.95
	ELSH-F51O1-0LPNM-AR3R4	52	610~620	1.75~2.95
	*ELSH-F61O1-0LPNM-AR3R4	60	610~620	1.75~2.95
<b>Amber</b>	ELSH-F31Y1-0LPNM-AA3A5	39	585~592.5	1.75~2.95
	ELSH-F41Y1-0LPNM-AA3A5	45	585~592.5	1.75~2.95
	*ELSH-F51Y1-0LPNM-AA3A5	52	585~592.5	1.75~2.95
	ELSH-F31Y1-0LPNM-AA4A6	39	587.5~595	1.75~2.95
	ELSH-F41Y1-0LPNM-AA4A6	45	587.5~595	1.75~2.95
	*ELSH-F51Y1-0LPNM-AA4A6	52	587.5~595	1.75~2.95
<b>Green</b>	ELSH-F71G1-0LPNM-CG1G2	70	520~530	2.95~3.85
	*ELSH-F81G1-0LPNM-CG1G2	80	520~530	2.95~3.85
	ELSH-F71G1-0LPNM-CG2G3	70	525~535	2.95~3.85
	*ELSH-F81G1-0LPNM-CG2G3	80	525~535	2.95~3.85
<b>Blue</b>	ELSH-E61B1-0LPNM-CB7B8	13	460~470	2.95~3.85
	*ELSH-E71B1-0LPNM-CB7B8	17	460~470	2.95~3.85

Color	Order Code of ELSH	Minimum Radiometric Power (mW)	Peak Wavelength (nm)	Forward Voltage(V)
Royal Blue	*ELSH-Q91L1-0LPNM-CB4B6	275	445~460	2.95~3.85
Deep Red	ELSH-Q91E1-0LPNM-BD3D8	275	645~675	2.05~2.95
Far Red	ELSH-Q61F1-0LPNM-BF3F8	125	715~745	2.05~2.95

**Note:**

1. Please contact sales for timing and availability of P/N's marked with an asterisk "\*\*".



## Product Binning

### Luminous Flux Bins

Group	Bin	Minimum Photometric Flux (lm)	Maximum Photometric Flux (lm)
E	1	4	5
	2	5	6
	3	6	8
	4	8	10
	5	10	13
	6	13	17
	7	17	20
	8	20	23
	9	23	27
F	1	27	33
	2	33	39
	3	39	45
	4	45	52
	5	52	60
	<b>6</b>	<b>60</b>	<b>70</b>
	<b>7</b>	<b>70</b>	<b>80</b>
	<b>8</b>	<b>80</b>	<b>90</b>
	<b>9</b>	<b>90</b>	<b>100</b>

Group	Bin	Minimum Photometric Flux (lm)	Maximum Photometric Flux (lm)
J	1	100	110
	2	110	120
	3	120	130
	4	130	140
	5	140	150
	6	150	160
	7	160	180
	8	180	200
	9	200	225
K	1	225	250
	2	250	275
	3	275	300
	4	300	325
	5	325	350
	6	350	375
	7	375	400
	8	400	425
	9	425	450
N	1	450	475
	2	475	500
	3	500	525
	4	525	550

**Note:** Currently available brightness bins for White LEDs are highlighted and bolded.

### Radiometric Power Bins

Group	Bin	Minimum Radiometric Power(mW)	Maximum Radiometric Power(mW)
Q	1	0	25
	2	25	50
	3	50	75
	4	75	100
	5	100	125
	6	125	175
	7	175	225
	8	225	275
	9	275	350

Group	Bin	Minimum Radiometric Power(mW)	Maximum Radiometric Power(mW)
R	1	350	425
	2	425	500
	3	500	600
	4	600	700
	5	700	800
	6	800	900
	7	900	1000
	8	1000	1300
	9	1300	1600

### White Bin Structure

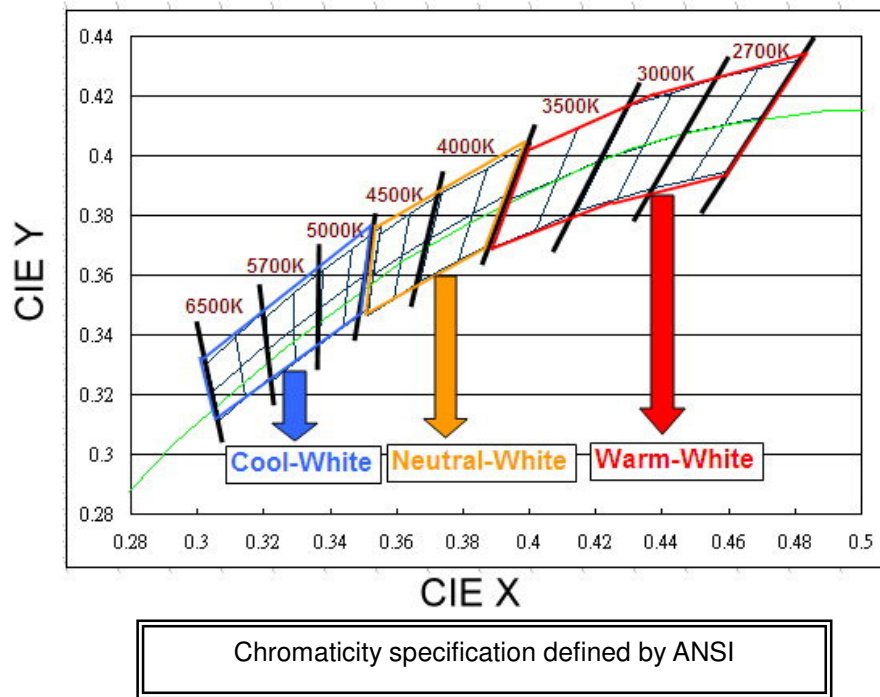

**Notes:**

1. The CCT range of Cool-White varies from 4745K to 7050K.
2. The CCT range of Neutral-White varies from 3710K to 4745K.
3. The CCT range of Warm-White varies from 2580K to 3710K
4. Color coordinates measurement allowance :  $\pm 0.01$
5. Color bins are defined at  $I_f=350\text{mA}$  operation.

### Cool-White Bin Structure

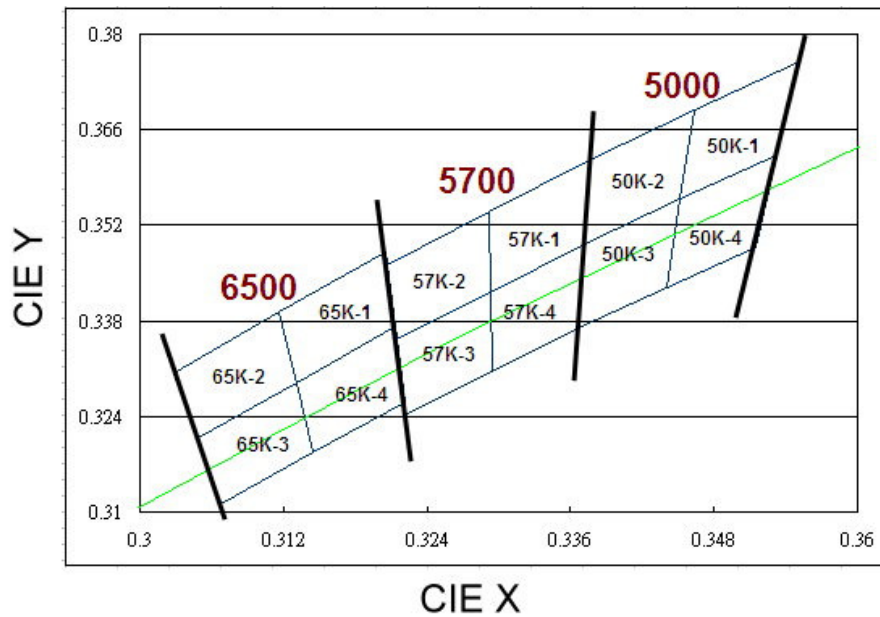

## Cool-White Bin Coordinates

### 5000K

Bin	CIE X	CIE Y
50K-1	0.346	0.369
	0.345	0.356
	0.353	0.362
	0.355	0.376
Reference Range: 4745~5000K		

Bin	CIE X	CIE Y
50K-2	0.338	0.362
	0.337	0.349
	0.345	0.356
	0.346	0.369
Reference Range: 5000~5310K		

Bin	CIE X	CIE Y
50K-4	0.345	0.356
	0.344	0.343
	0.352	0.349
	0.353	0.362
Reference Range: 4745~5000K		

Bin	CIE X	CIE Y
50K-3	0.337	0.349
	0.337	0.337
	0.344	0.343
	0.345	0.356
Reference Range: 5000~5310K		

### 5700K

Bin	CIE X	CIE Y
57K-1	0.329	0.354
	0.329	0.342
	0.337	0.349
	0.338	0.362
Reference Range: 5310~5700K		

Bin	CIE X	CIE Y
57K-2	0.321	0.346
	0.321	0.335
	0.329	0.342
	0.329	0.354
Reference Range: 5700~6020K		

Bin	CIE X	CIE Y
57K-4	0.329	0.342
	0.329	0.331
	0.337	0.337
	0.337	0.349
Reference Range: 5310~5700K		

Bin	CIE X	CIE Y
57K-3	0.321	0.335
	0.322	0.324
	0.329	0.331
	0.329	0.342
Reference Range: 5700~6020K		

### 6500K

Bin	CIE X	CIE Y
65K-1	0.312	0.339
	0.313	0.329
	0.321	0.337
	0.321	0.348
Reference Range: 6020~6500K		

Bin	CIE X	CIE Y
65K-2	0.303	0.330
	0.305	0.321
	0.313	0.329
	0.312	0.339
Reference Range: 6500~7050K		

Bin	CIE X	CIE Y
65K-4	0.313	0.329
	0.314	0.319
	0.322	0.326
	0.321	0.337
Reference Range: 6020~6500K		

Bin	CIE X	CIE Y
65K-3	0.305	0.321
	0.307	0.311
	0.314	0.319
	0.313	0.329
Reference Range: 6500~7050K		

### Neutral-White Bin Structure

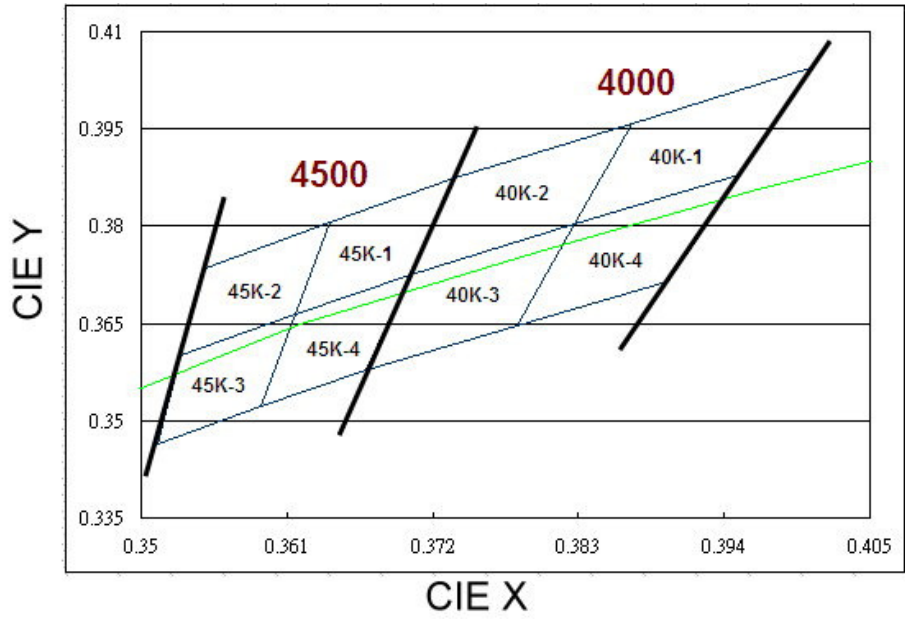

### Neutral-White Bin Coordinates

#### 4000K

Bin	CIE X	CIE Y
40K-1	0.387	0.396
	0.383	0.380
	0.395	0.388
	0.401	0.404
Reference Range: 3710~4000K		

Bin	CIE X	CIE Y
40K-2	0.374	0.387
	0.370	0.373
	0.383	0.380
	0.387	0.396
Reference Range: 4000~4260K		

Bin	CIE X	CIE Y
40K-4	0.383	0.380
	0.378	0.365
	0.390	0.372
	0.395	0.388
Reference Range: 3710~4000K		

Bin	CIE X	CIE Y
40K-3	0.370	0.373
	0.367	0.358
	0.378	0.365
	0.383	0.380
Reference Range: 4000~4260K		

#### 4500K

Bin	CIE X	CIE Y
45K-1	0.364	0.381
	0.362	0.366
	0.370	0.373
	0.374	0.387
Reference Range: 4260~4500K		

Bin	CIE X	CIE Y
45K-2	0.355	0.374
	0.353	0.360
	0.362	0.366
	0.364	0.381
Reference Range: 4500~4745K		

Bin	CIE X	CIE Y
45K-4	0.362	0.366
	0.359	0.352
	0.367	0.358
	0.370	0.373
Reference Range: 4260~4500K		

Bin	CIE X	CIE Y
45K-3	0.353	0.360
	0.351	0.347
	0.359	0.352
	0.362	0.366
Reference Range: 4500~4745K		

### Warm-White Bin Structure

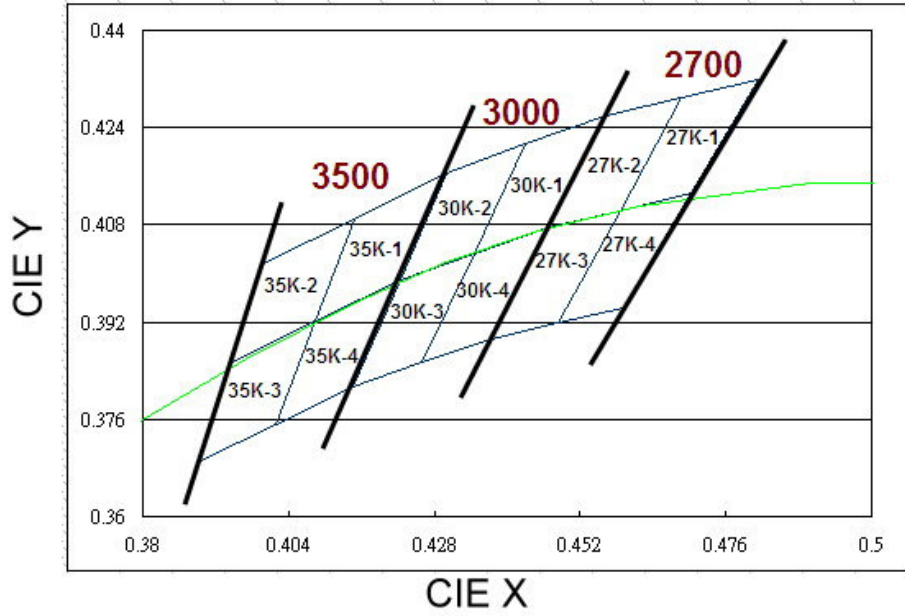

### Warm-White Bin Coordinates

#### 2700K

Bin	CIE X	CIE Y
27K-1	0.469	0.429
	0.459	0.410
	0.470	0.413
	0.481	0.432
Reference Range: 2580~2700K		

Bin	CIE X	CIE Y
27K-2	0.456	0.426
	0.447	0.408
	0.459	0.410
	0.469	0.429
Reference Range: 2700~2870K		

Bin	CIE X	CIE Y
27K-4	0.459	0.410
	0.448	0.392
	0.459	0.394
	0.470	0.413
Reference Range: 2580~2700K		

Bin	CIE X	CIE Y
27K-3	0.447	0.408
	0.437	0.389
	0.448	0.392
	0.459	0.410
Reference Range: 2700~2870K		

#### 3000K

Bin	CIE X	CIE Y
30K-1	0.443	0.421
	0.435	0.403
	0.447	0.408
	0.456	0.426
Reference Range: 2870~3000K		

Bin	CIE X	CIE Y
30K-2	0.430	0.417
	0.422	0.399
	0.435	0.403
	0.443	0.421
Reference Range: 3000~3220K		

Bin	CIE X	CIE Y
30K-4	0.435	0.403
	0.426	0.385
	0.437	0.389
	0.447	0.408
Reference Range: 2870~3000K		

Bin	CIE X	CIE Y
30K-3	0.422	0.399
	0.415	0.381
	0.426	0.385
	0.435	0.403
Reference Range: 3000~3220K		

### 3500K

Bin	CIE X	CIE Y
35K-1	0.415	0.409
	0.408	0.392
	0.422	0.399
	0.430	0.417
Reference Range: 3220~3500K		

Bin	CIE X	CIE Y
35K-2	0.400	0.402
	0.394	0.385
	0.408	0.392
	0.415	0.409
Reference Range: 3500~3710K		

Bin	CIE X	CIE Y
35K-4	0.408	0.392
	0.402	0.375
	0.415	0.381
	0.422	0.399
Reference Range: 3220~3500K		

Bin	CIE X	CIE Y
35K-3	0.394	0.385
	0.389	0.369
	0.402	0.375
	0.408	0.392
Reference Range: 3500~3710K		

### Forward Voltage Bins

Group Name	Bins
A	U1+U2+U3
B	U2+U3+U4
<b>C</b>	<b>V1+V2+V3</b>
D	V2+V3+V4
E	V3+V4+V5
F	V1+V2
G	V1
H	U3+U4

Bin	Minimum Forward Voltage (V)	Maximum Forward Voltage (V)
U1	1.75	2.05
U2	2.05	2.35
U3	2.35	2.65
U4	2.65	2.95
<b>V1</b>	<b>2.95</b>	<b>3.25</b>
<b>V2</b>	<b>3.25</b>	<b>3.55</b>
<b>V3</b>	<b>3.55</b>	<b>3.85</b>
V4	3.85	4.15
V5	4.15	4.45

#### Notes:

1. Forward voltage measurement tolerance:  $\pm 0.1V$ .
2. Forward voltage bins are defined at  $I_f=350$  mA operation.

## Color Bins

Group	Bin	Minimum Dominant / Peak Wavelength (nm)	Maximum Dominant / Peak Wavelength (nm)
<b>B</b> (Blue) / Royal-Blue	1	430	435
	2	435	440
	3	440	445
	4	445	450
	5	450	455
	6	455	460
	7	460	465
	8	465	470
<b>G</b> (Green)	1	520	525
	2	525	530
	3	530	535
	4	535	540
	5	540	545
	6	545	550
<b>A</b> (Amber)	1	580	582.5
	2	582.5	585
	3	585	587.5
	4	587.5	590
	5	590	592.5
	6	592.5	595
<b>R</b> (Red)	3	610	615
	4	615	620
	5	620	625
	6	625	630
	7	630	635
<b>D</b> (Deep-Red)	1	635	640
	2	640	645
	3	645	650
	4	650	655
	5	655	660
	6	660	665
	7	665	670
	8	670	675
<b>F</b> (Far-Red)	1	700	710
	2	710	715
	3	715	720
	4	720	725
	5	725	730
	6	730	735
	7	735	740
	8	740	745

**Notes.**

1. Dominant / Peak wavelength measurement tolerance:  $\pm 1\text{nm}$ .
2. Dominant / Peak wavelength bins are defined at  $I_f=350\text{ mA}$  operation.
3. The range of wavelength in Royal-Blue, Deep-Red and Far-Red is described as peak-wavelength.

## Optical Characteristics

Color	Part Number	Part Number Dominant Wavelength $\lambda_D$ Peak Wavelength $\lambda_P$ Color Temperature CCT			Typical Temperature Coefficient of Dominant Wavelength (nm/°C)-( $\Delta\lambda_D/\Delta T_J$ )	Typical Viewing Angle (degrees) $2\theta_{1/2}$
		Min.	Typ.	Max.		
Cool-White	ELSH – XX1CX	4745K	5700K	7050K	---	120
Neutral-White	ELSH – XX1NX	3710K	4260K	4745K	---	120
Warm-White	ELSH – XX1MX	2580K	3000K	3710K	---	120
Red	ELSH – XX1RX	620nm	---	630nm	0.05	120
Orange	ELSH – XX1OX	610nm	---	620nm	0.08	120
Amber	ELSH – XX1YX	585nm	---	595nm	0.1	120
Green	ELSH – XX1GX	520nm	---	535nm	0.05	120
Blue	ELSH – XX1BX	460nm	---	470nm	0.05	120
Royal Blue	ELSH – XX1LX	445nm	---	460nm	0.05	120
Deep-Red	ELSH – XX1EX	645nm	---	675nm	0.08	120
Far-Red	ELSH – XX1LX	715nm	---	745nm	0.04	120

### Notes:

1. The test tolerance of Everlight is  $\pm 1\text{nm}$  for dominant wavelength,  $\pm 5\%$  for CCT.
2. Viewing angle is the width of half the light output intensity in all directions of  $180^\circ$ .
3. All Cool-White, Neutral-White, Warm-White, and dominant wavelength below 550nm LEDs are made with Indium Gallium Nitride (InGaN).
4. All LEDs with dominant wavelength exceeding 550nm are made with Aluminum Indium Gallium Phosphide (AlInGaP).
5. The range of wavelength in Royal-Blue, Deep-Red and Far-Red is described as peak-wavelength.



## Mechanical Dimension

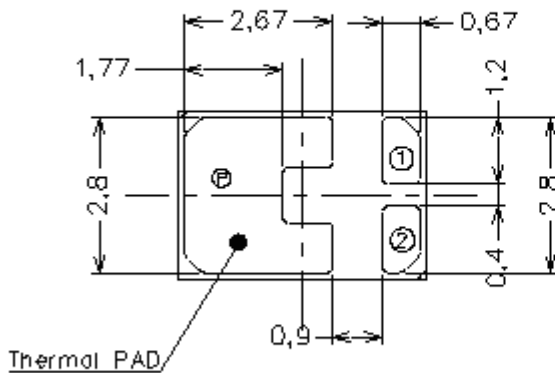
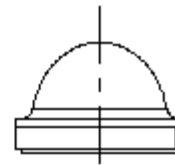
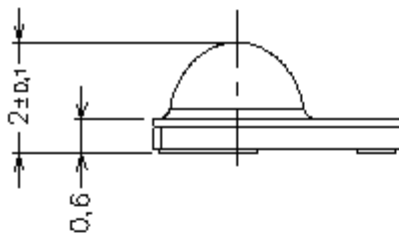
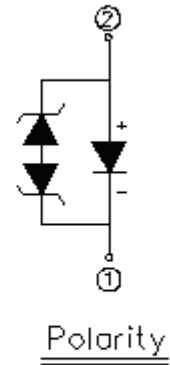
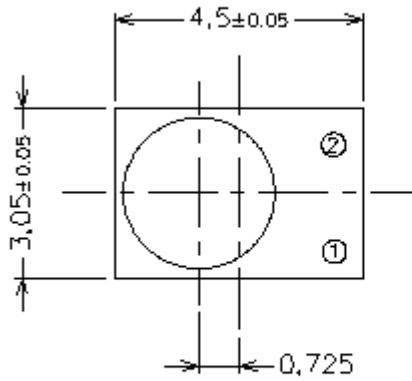

Bot. view

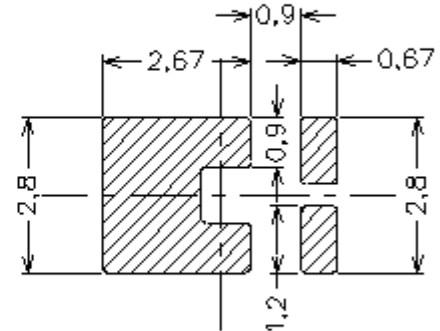

Soldering patterns

### Notes.

1. Dimensions are in millimeters.
2. Tolerances unless mentioned are  $\pm 0.1$ mm.
3. Do not handle the device by the lens. Incorrect force applied to the lens may lead to the failure of devices.

## Pad Configuration

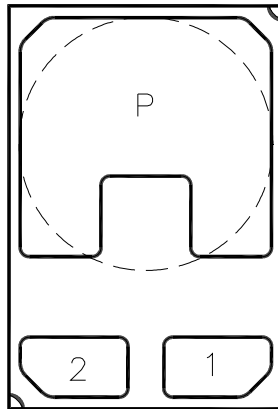

**BOTTOM VIEW**

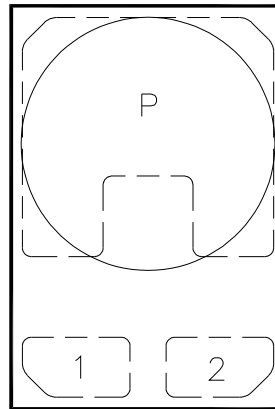

**TOP VIEW**

PAD	FUNCTION
1	ANODE
2	CATHODE
P	THERMAL PAD

## Reflow Soldering Characteristics

### For Reflow Process

- a. ELSH series are suitable for SMT processes.
- b. Curing of glue in oven must be according to standard operation flow processes.

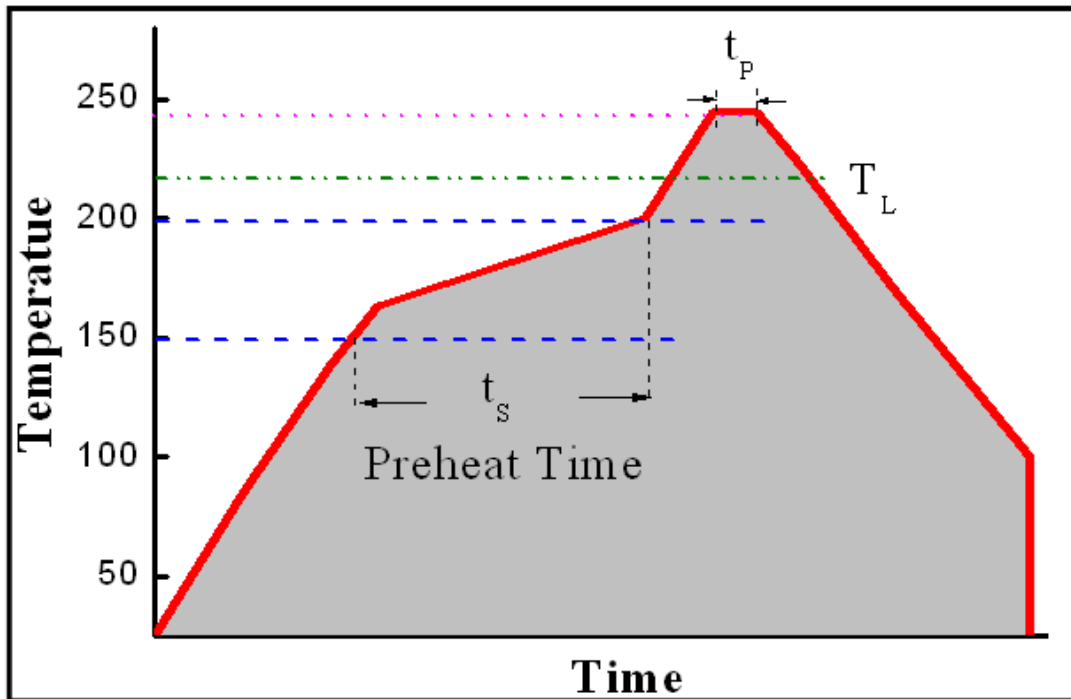

Profile Feature	Lead Free Assembly
Ramp-Up Rate	2-3 °C/S
Preheat Temperature	150-200 °C
Preheat Time ( $t_s$ )	60-120 S
Liquid Temperature ( $T_L$ )	217 °C
Time maintained above $T_L$	60-90 S
Peak Temperature ( $T_p$ )	240±5 °C
Peak Time ( $t_p$ )	Max 20 S
Ramp-Down Rate	3-5 °C/S

- c. Reflow soldering should not be done more than twice.
- d. In soldering process, stress on the LEDs during heating should be avoided.
- e. After soldering, do not bend the circuit board.

## Wavelength Characteristics

**For Deep-Red, Red, Amber, Yellow, Green, Cyan, Blue, Royal-Blue**  
**@ Thermal Pad Temperature = 25°C**

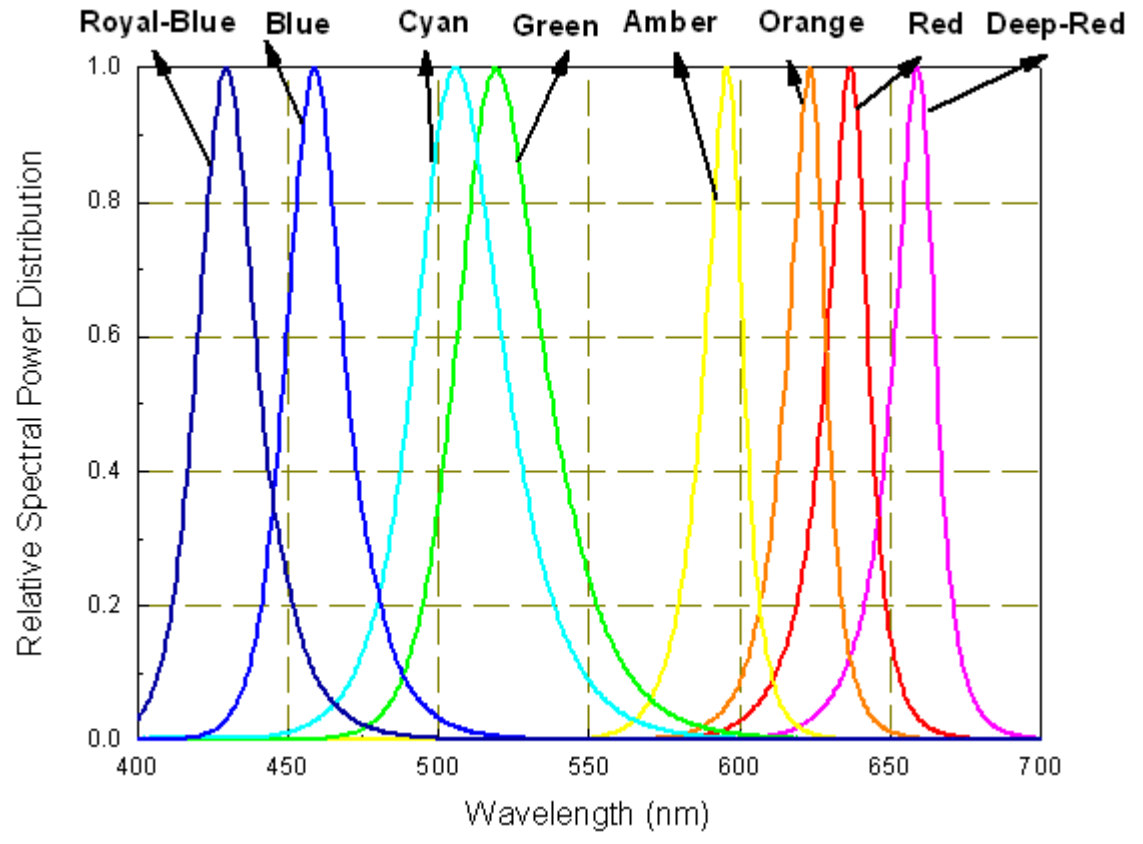

**For Cool-White, @ Thermal Pad Temperature = 25°C**

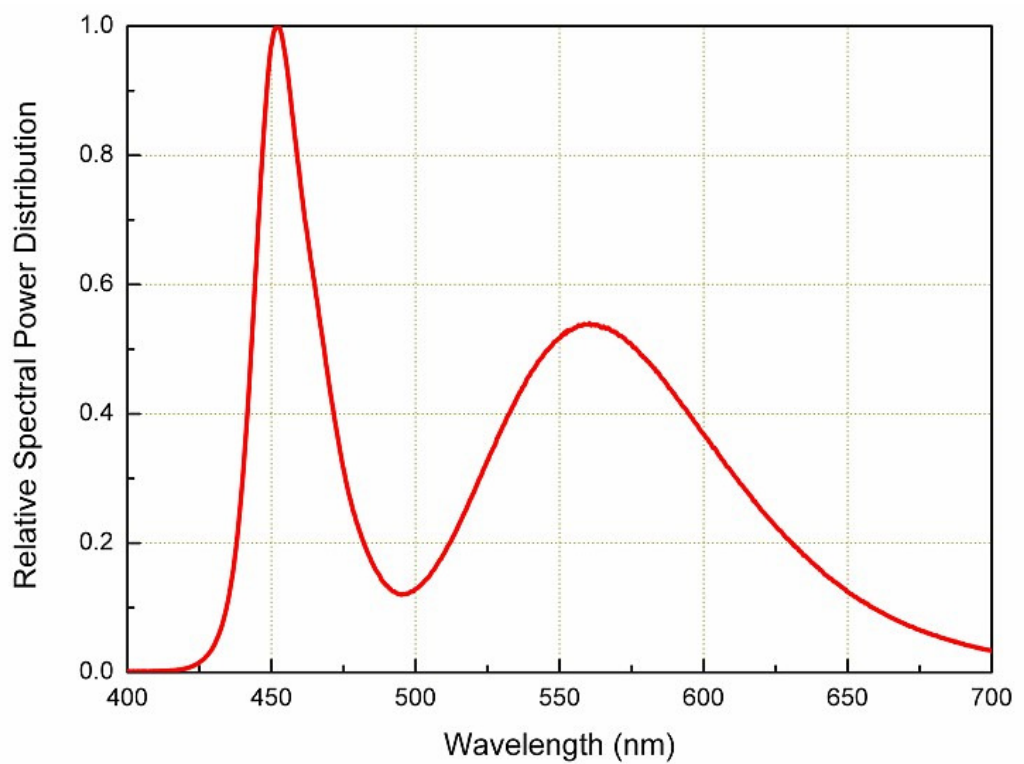

**For Neutral-White, @ Thermal Pad Temperature = 25°C**

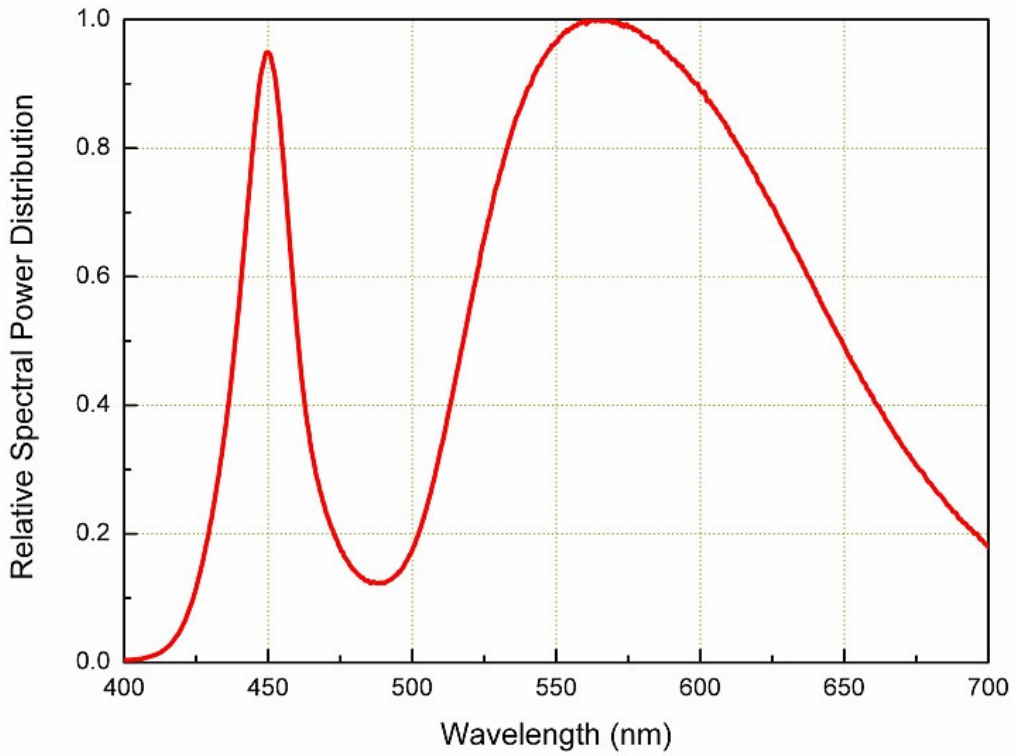

**For Warm-White, @ Thermal Pad Temperature = 25°C**

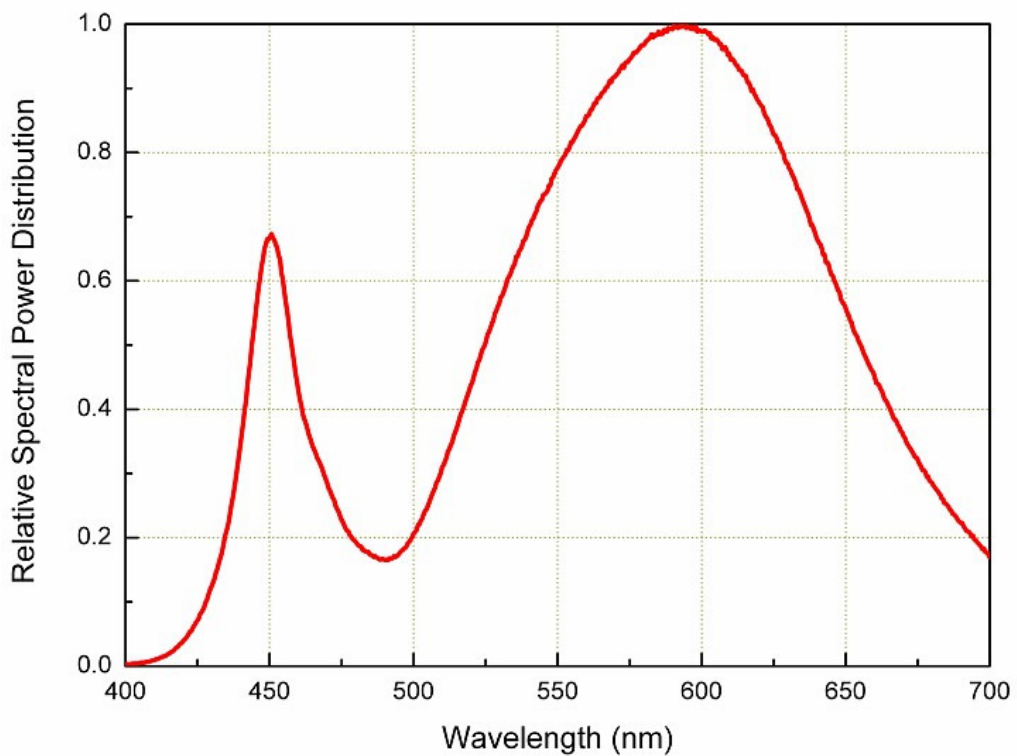

## Typical Light Output Characteristic vs. Thermal Pad Temperature

Cool-White, Neutral-White, Warm-White, Green, Cyan, Blue, Royal-Blue for 350mA Drive Current

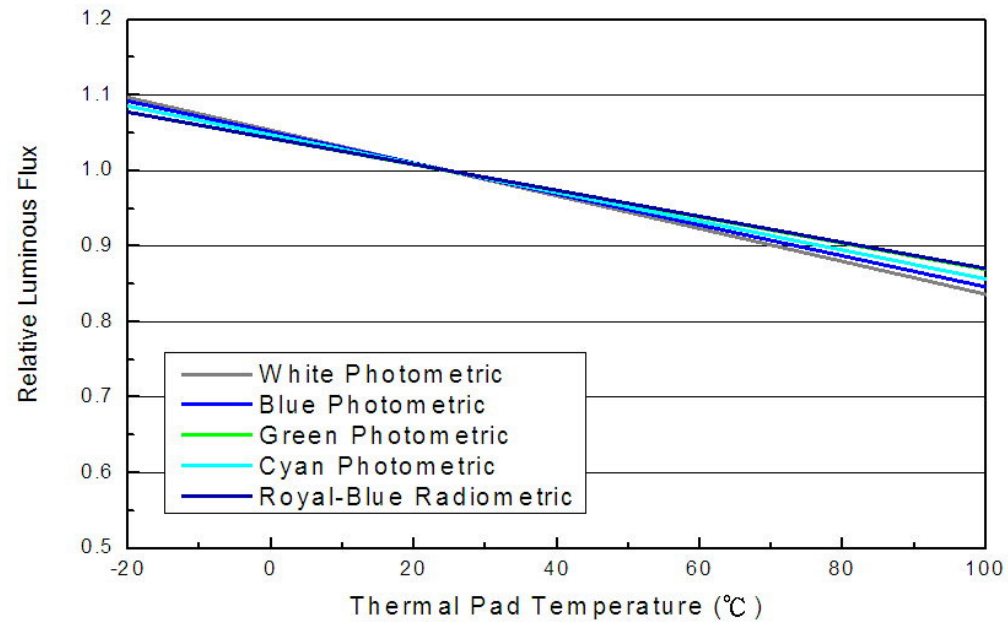

Deep-Red, Red, Orange, Amber for 350mA Drive Current

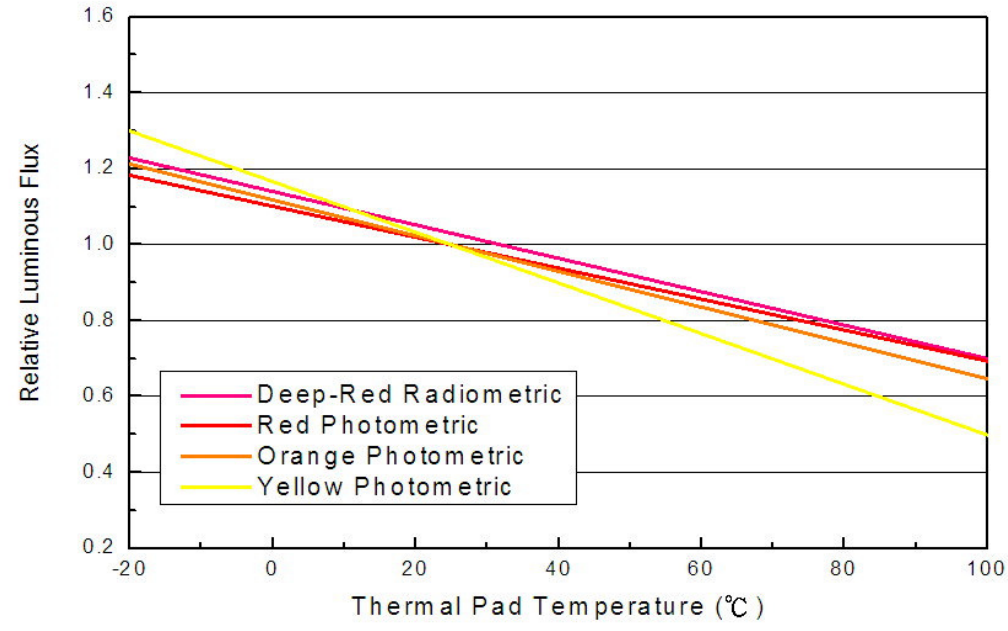

## Typical Electrical Characteristics

For Cool-White, Neutral-White, Warm-White, Green, Cyan, Blue, Royal-Blue  
@ Thermal Pad Temperature = 25°C

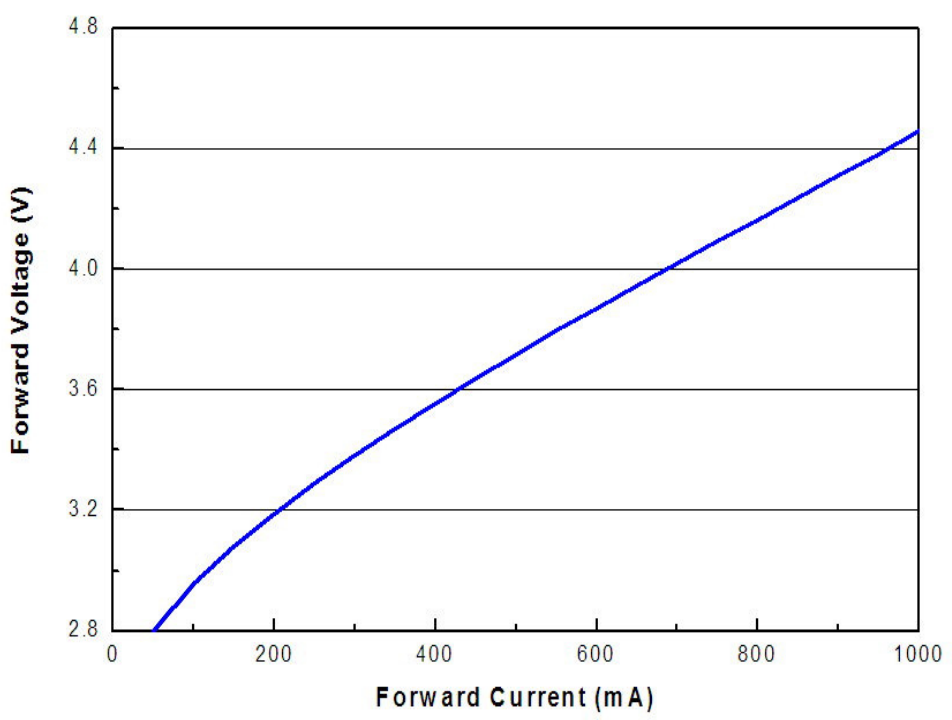

For Far-Red, Deep-Red, Red, Orange, Amber,  
@ Thermal Pad Temperature = 25°C

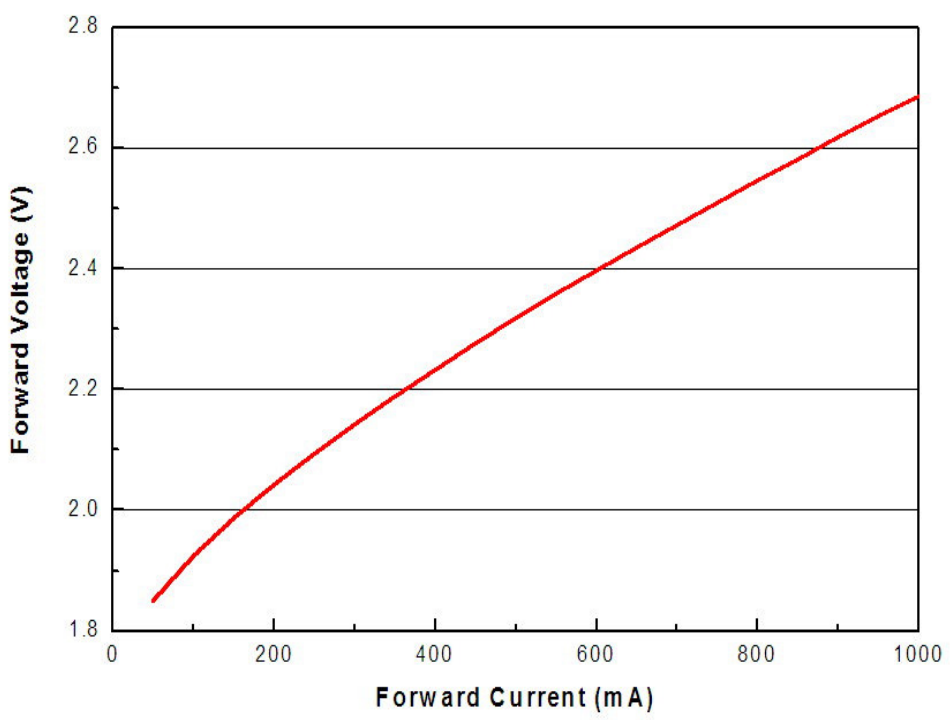

## Typical Relative Luminous Flux vs. Forward Current

For Cool-White, Neutral-White, Warm-White  
@ Thermal Pad Temperature = 25°C

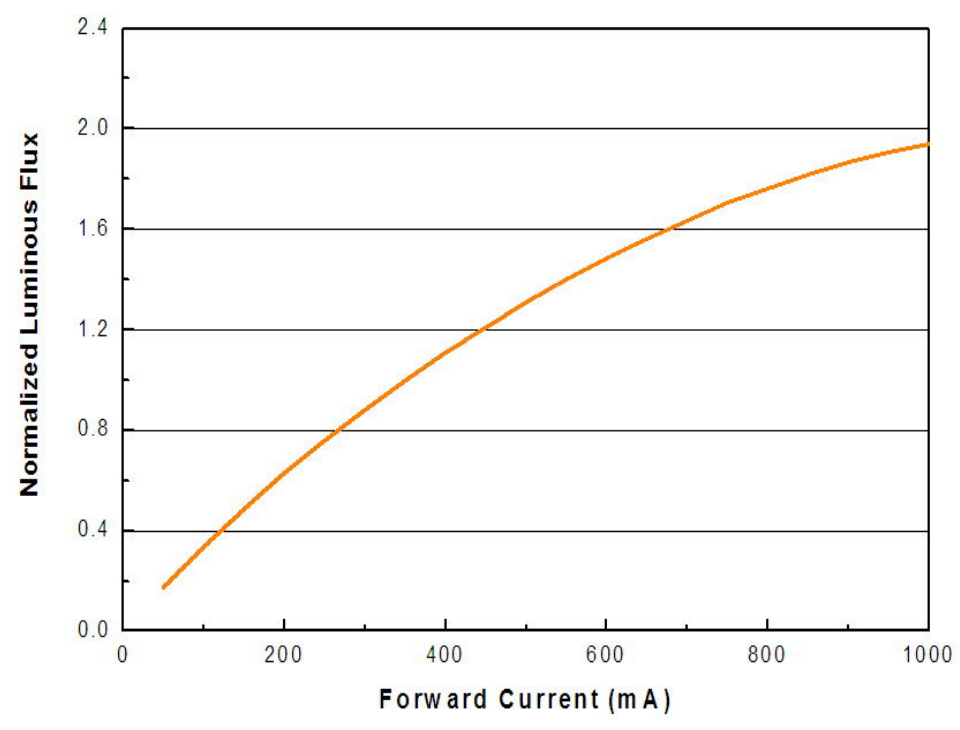

For Green, Cyan, Blue, Royal-Blue @ Thermal Pad Temperature = 25°C

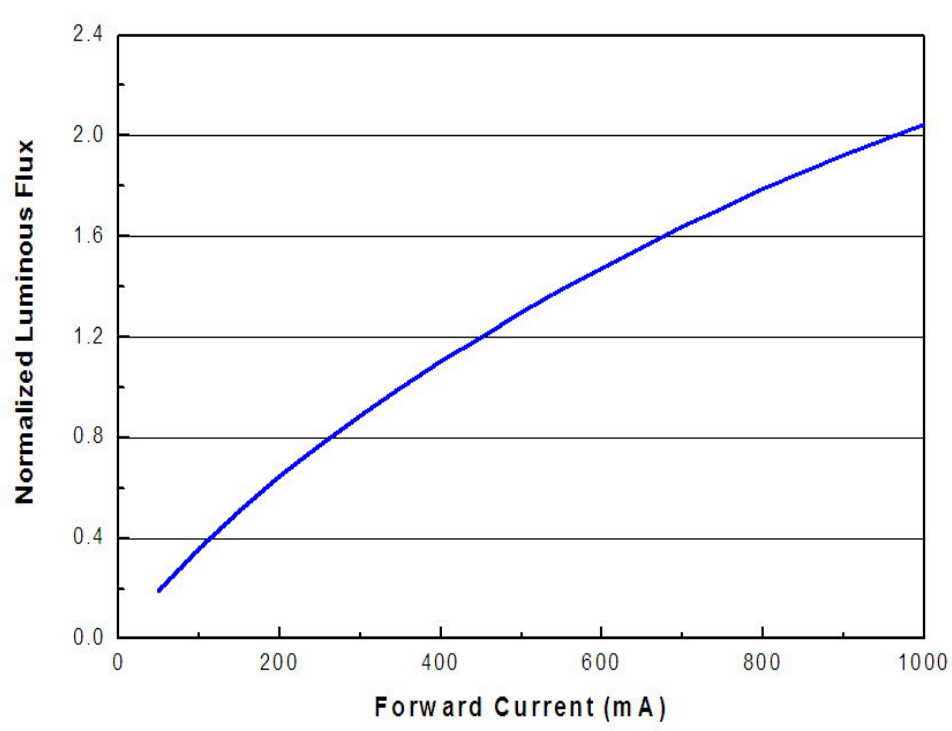



**For Far-Red, Deep-Red, Red, Orange, Amber,  
@ Thermal Pad Temperature = 25°C**

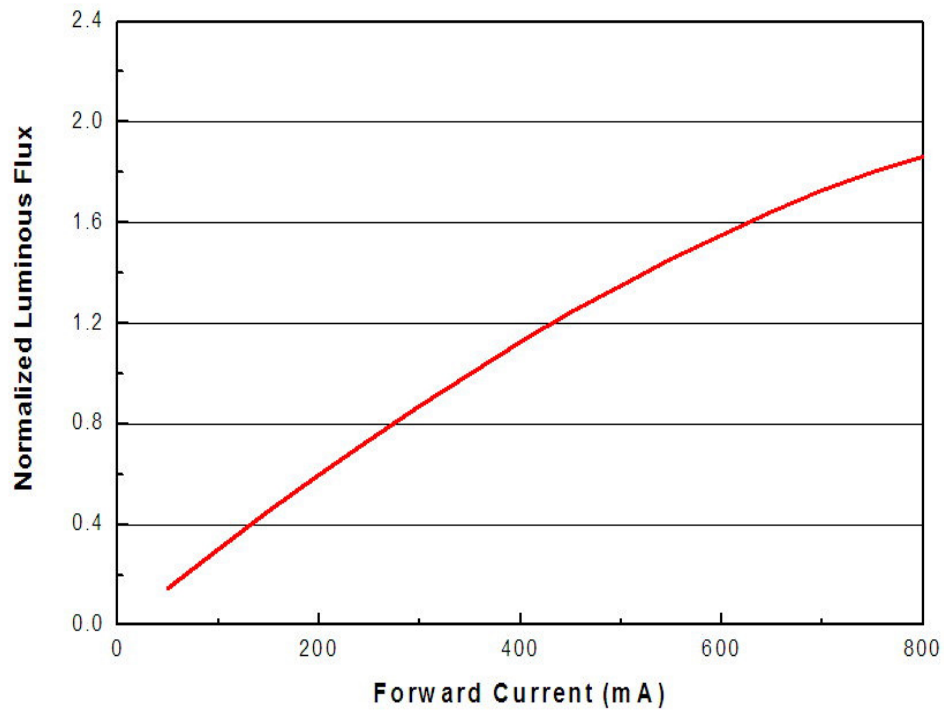

## Typical Wavelength & CCT Shift Characteristics vs. Forward Current

For Cool-White @ Thermal Pad Temperature = 25°C

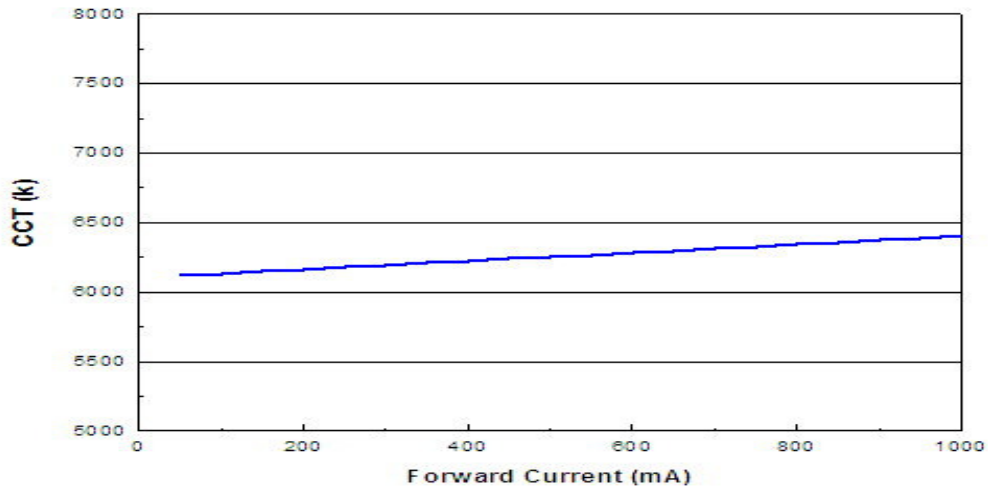

For Neutral-White @ Thermal Pad Temperature = 25°C

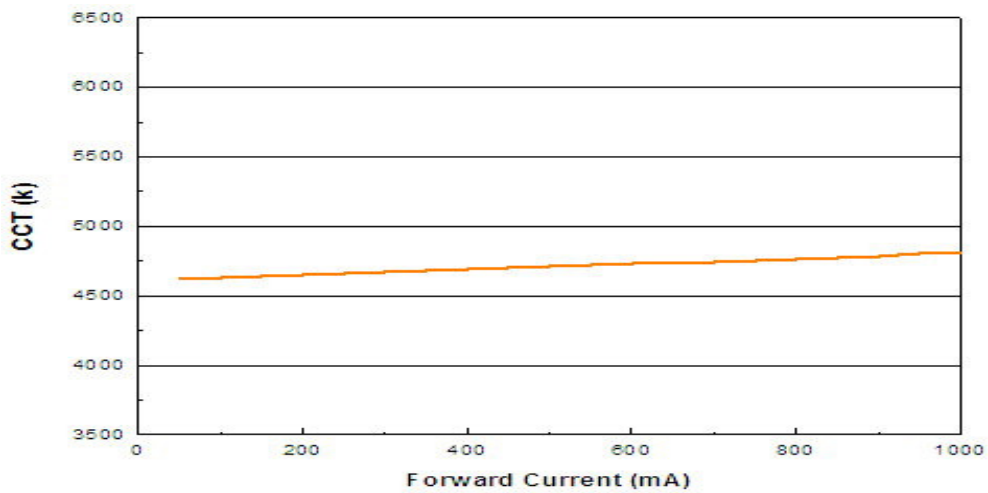

For Warm-White @ Thermal Pad Temperature = 25°C

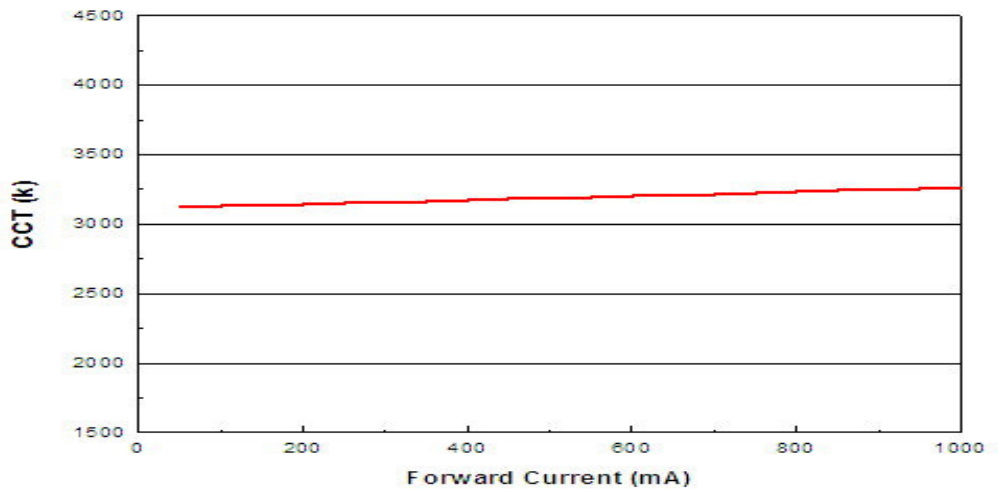

**For Blue @ Thermal Pad Temperature = 25°C**

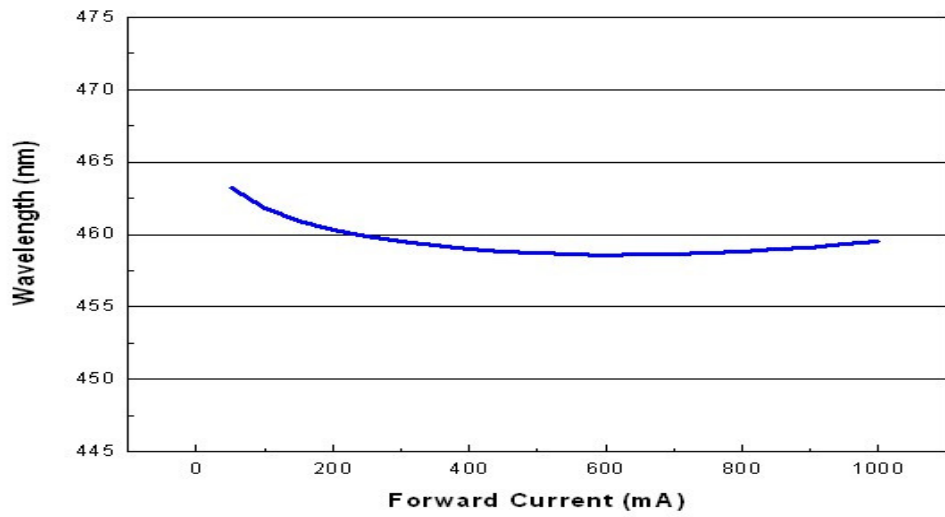

**For Green @ Thermal Pad Temperature = 25°C**

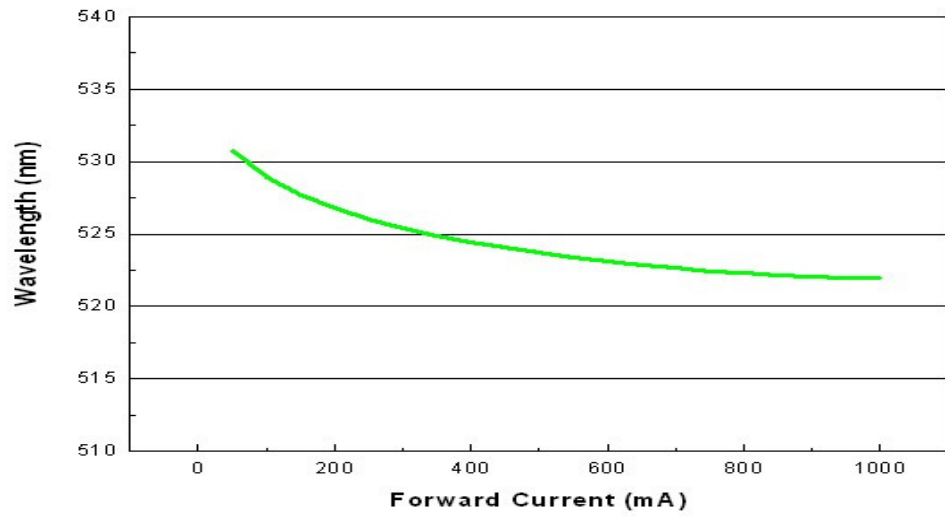

**For Red @ Thermal Pad Temperature = 25°C**

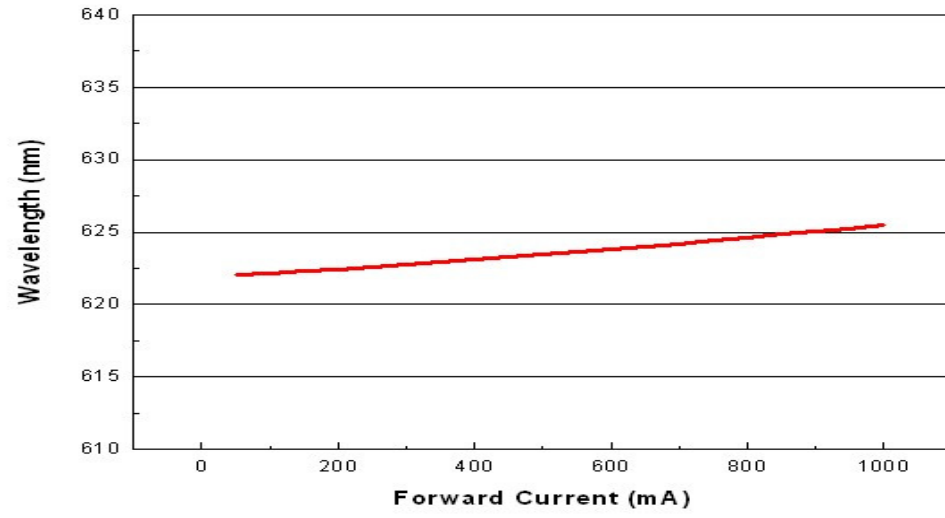

## Current Derating Curves

### Current Derating Curve for 350mA Drive Current Cool-White, Neutral-White, Warm-White, Green, Cyan, Blue, Royal-Blue, Far-Red, Deep-Red, Red, Amber, Yellow

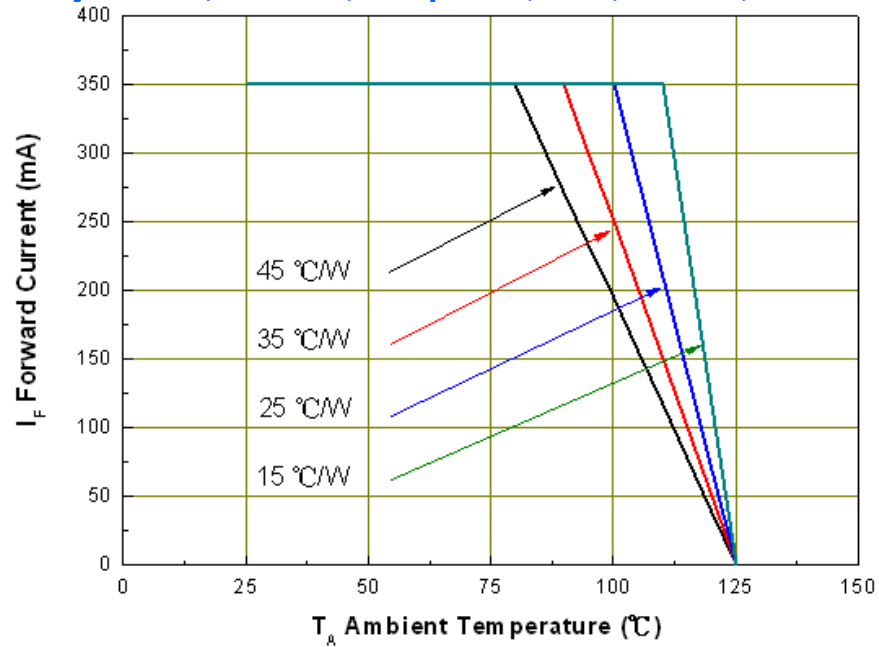

**Note:**

The current derating curves are depending on the thermal resistance between the junction to the soldering pad.

## Typical Radiation Patterns

### Typical Spatial Radiation Pattern for Cool-White, Neutral-White, Warm-White Lambertian

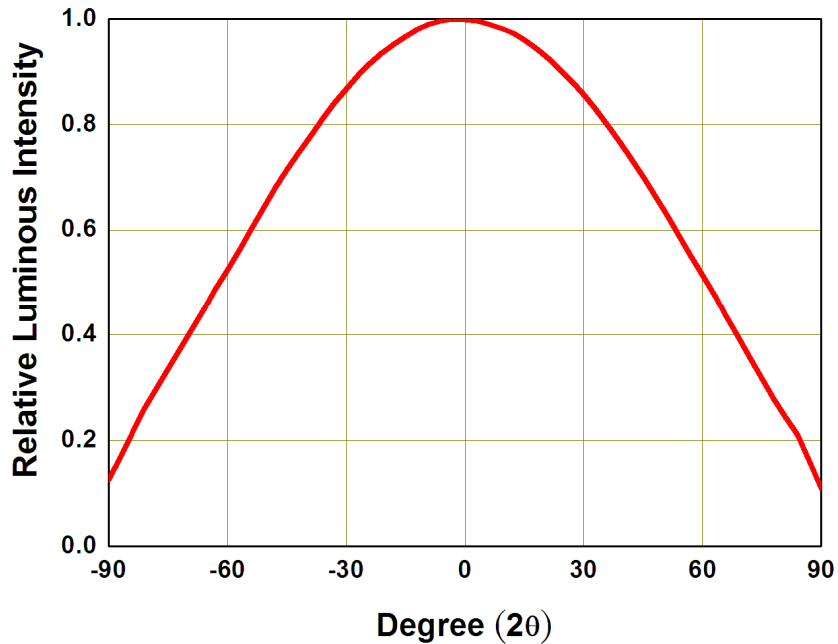

**Notes.**

1.  $2\theta_{1/2}$  is the off axis angle from lamp centerline where the luminous intensity is 1/2 of the peak value.
2. View angle tolerance is  $\pm 5^\circ$ .

### Typical Polar Radiation Pattern for Cool-White, Neutral-White, Warm-White Lambertian

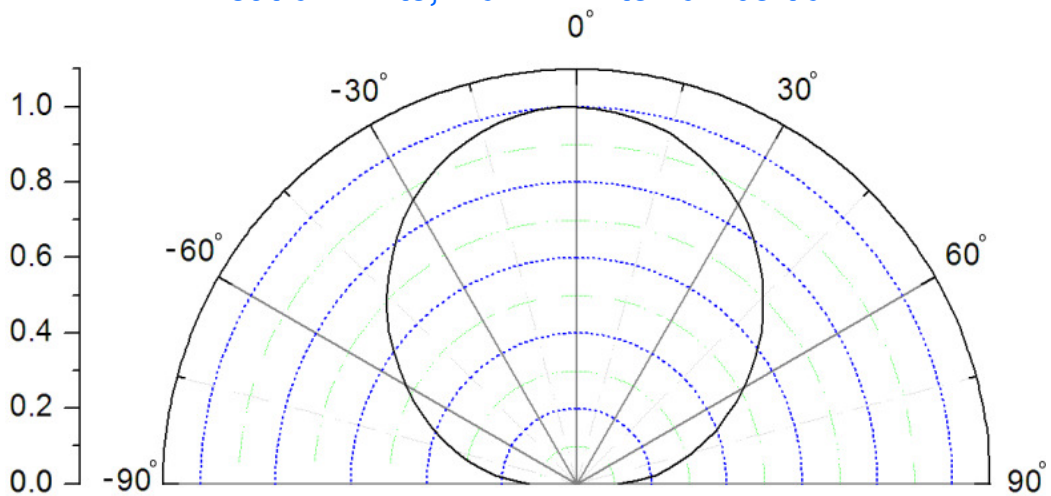

### Typical Difference of CIE X of Cool-White Versus Angle

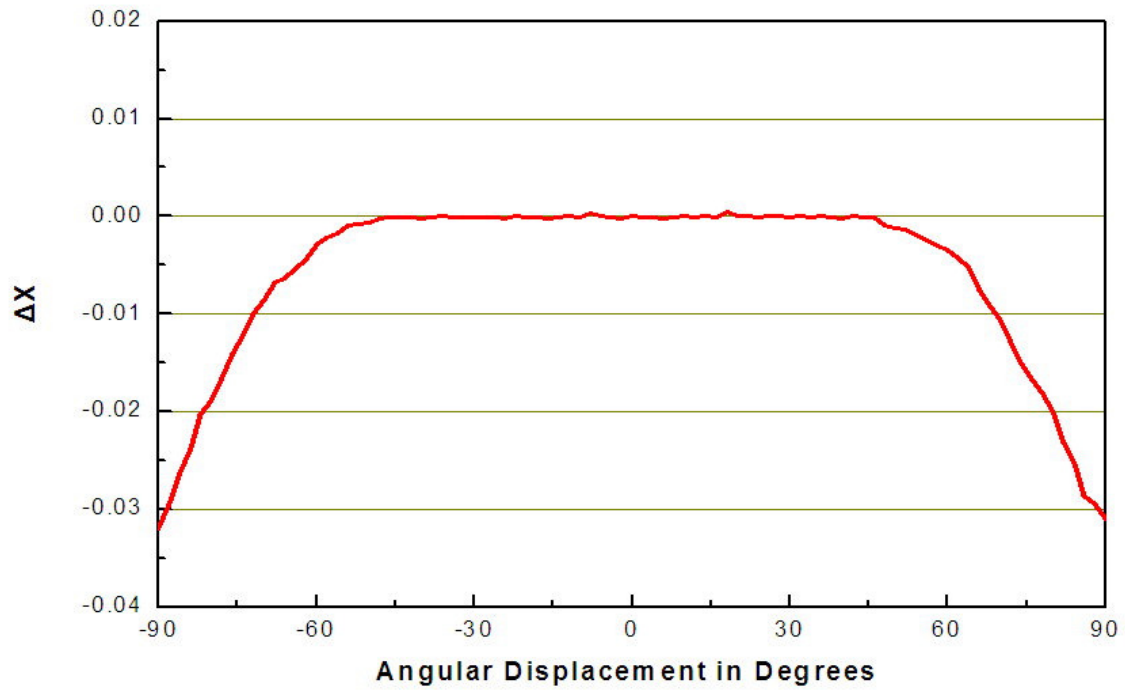

### Typical Difference of CIE Y of Cool-White Versus Angle

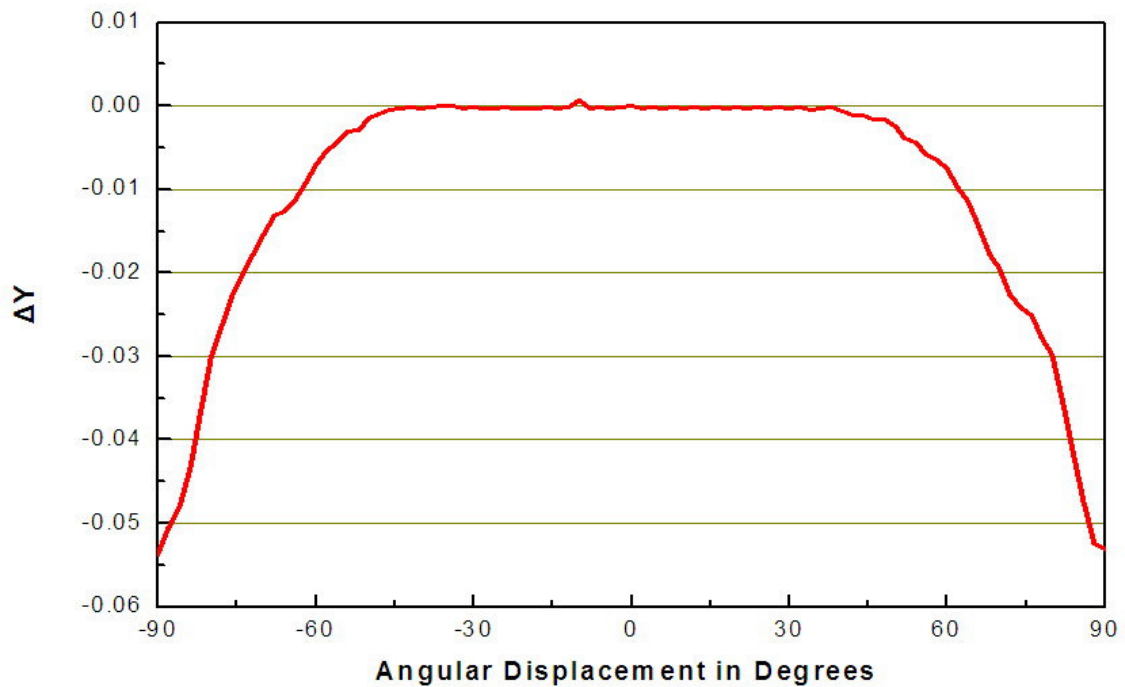

## Emitter Tape Packaging

Carrier Tape Dimensions: Loaded quantity 400 PCS per reel

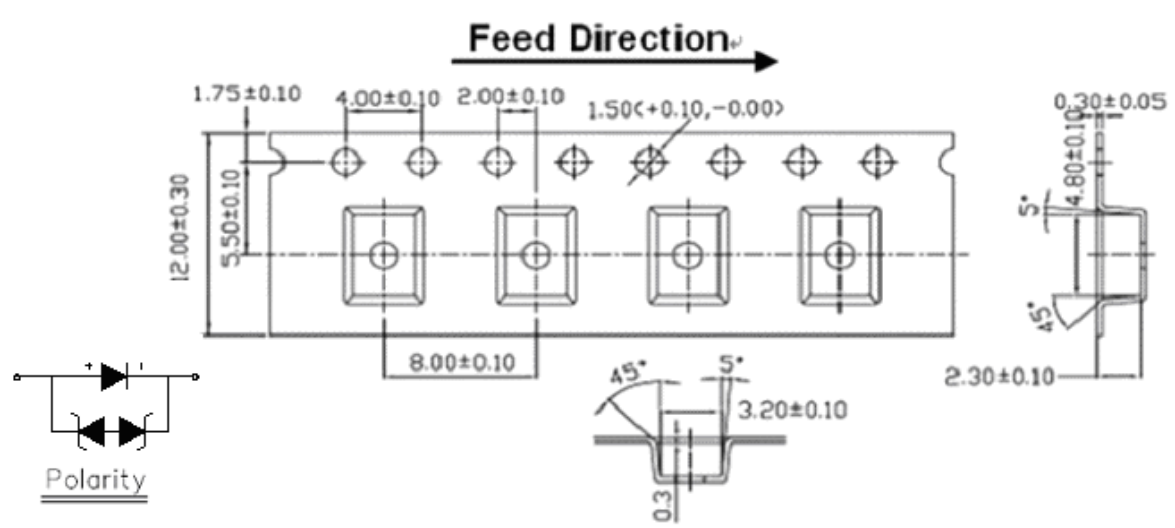

### Notes.

1. Dimensions are in millimeters.
2. Tolerances for fixed dimensions are  $\pm 0.1$  mm.

## Moisture Resistant Packaging

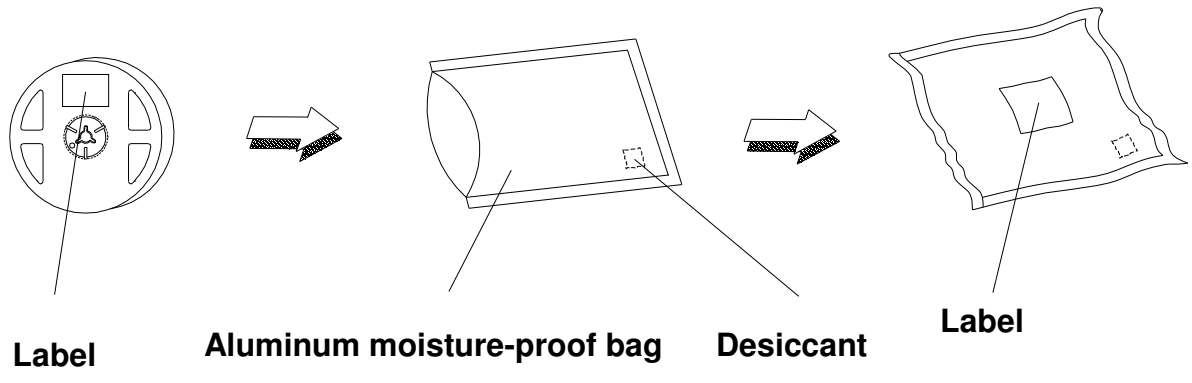

## Emitter Reel Packaging

### Reel Dimensions

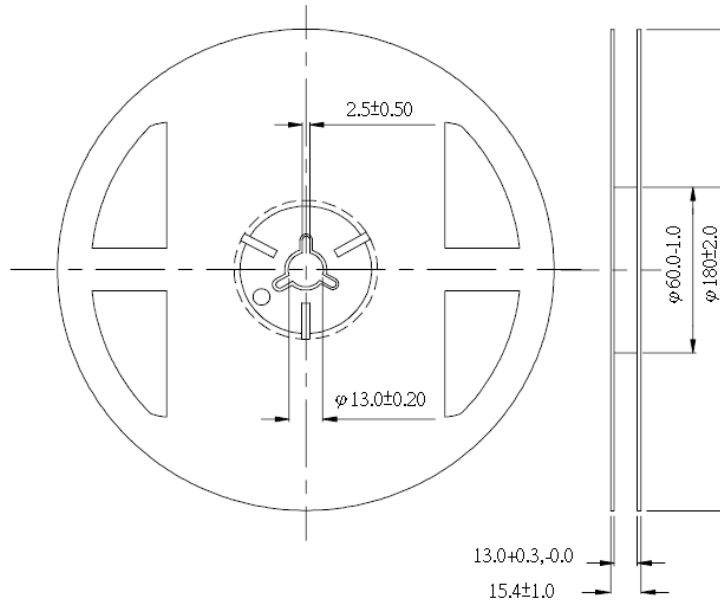

#### Notes :

1. Dimensions are in millimeters.
2. Tolerances unless mentioned are  $\pm 0.1$  mm.

## Product Labeling

### Label Explanation

CPN: Customer Specification (when required)

P/N : Everlight Production Number

QTY: Packing Quantity

CAT: Luminous Flux (Brightness) Bin

HUE: Color Bin

REF: Forward Voltage Bin

LOT No: Lot Number

MADE IN TAIWAN: Production Place





## Revision History

Current version: **2010/08/16**  
 Device No. DHE-0000751  
 Version. 5.0

Page	Subjects (major change in previous version)	Date of change
3、 4	Modify Product Nomenclature and Absolute Maximum Ratings.	2010/08/30
3、 5、 8、 16、 17	Add page for "With High CRI" with PHS and PFS part numbers. Added Royal Blue.	2010/08/16
6	Added a new PN that reaches CRI 90	2010/01/03
18	Created a new feature to recognize the optical center.	2010/02/09
14、 4、 5、 6、 7	Added a new voltage bin group. Luminous Flux Characteristics for the Shuen series	2010/04/12
8	Added new Deep-Red / Far-Red PN.	2010/5/14