

## Optocoupler, Phototransistor Output, With Base Connection, 110 °C Rated

### Features

- Operating temperature from - 55 °C to + 110 °C
- Breakdown Voltage, 5300 V<sub>RMS</sub>
- Long Term Stability
- Industry Standard Dual-in-Line Package
- Lead-free component
- Component in accordance to RoHS 2002/95/EC and WEEE 2002/96/EC

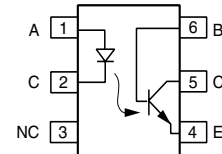
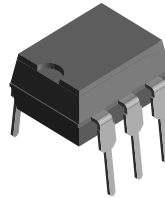

1179004



### Agency Approvals

- UL1577, File No. E52744 System Code H or J, Double Protection
- DIN EN 60747-5-2 (VDE0884)
- CUL - File No. E52744, equivalent to CSA bulletin 5A

The coupling device is suitable for signal transmission between two electrically separated circuits. The potential difference between the circuits to be coupled is not allowed to exceed the maximum permissible reference voltages.

### Applications

AC adapter  
SMPS  
PLC  
Factory Automation  
Game Consoles

### Order Information

Part	Remarks
CNY117-1	CTR 40 - 80 %, DIP-6
CNY117-2	CTR 63 - 125 %, DIP-6
CNY117-3	CTR 100 - 200 %, DIP-6
CNY117-4	CTR 160 - 320 %, DIP-6

For additional information on the available options refer to Option Information.

### Description

The CNY117 is a 110 °C rated optocoupler consisting of a Gallium Arsenide infrared emitting diode optically coupled to a silicon planar phototransistor detector in a plastic plug-in DIP-6 package.

### Absolute Maximum Ratings

$T_{amb} = 25\text{ }^{\circ}\text{C}$ , unless otherwise specified

Stresses in excess of the absolute Maximum Ratings can cause permanent damage to the device. Functional operation of the device is not implied at these or any other conditions in excess of those given in the operational sections of this document. Exposure to absolute Maximum Rating for extended periods of the time can adversely affect reliability.

### Input

Parameter	Test condition	Symbol	Value	Unit
Reverse voltage		$V_R$	6.0	V
DC Forward current		$I_F$	60	mA
Surge forward current	$t \leq 10\text{ }\mu\text{s}$	$I_{FSM}$	2.5	A
Power dissipation		$P_{diss}$	100	mW
Derate linearly from 25 °C			1.0	mW/°C

### Output

Parameter	Test condition	Symbol	Value	Unit
Collector-emitter breakdown voltage		$BV_{CEO}$	70	V
Collector current		$I_C$	50	mA
	$t \leq 1.0\text{ ms}$	$I_C$	100	mA
Total power dissipation		$P_{diss}$	150	mW
Derate linearly from 25 °C			1.5	mW/°C

### Coupler

Parameter	Test condition	Symbol	Value	Unit
Isolation test voltage (between emitter and detector referred to standard climate 23/50 DIN 50014)		$V_{ISO}$	5300	$V_{RMS}$
Creepage			$\geq 7.0$	mm
Clearance			$\geq 7.0$	mm
Isolation thickness between emitter and detector			$\geq 0.4$	mm
Comparative tracking index per DIN IEC 112/VDE 0303, part 1			175	
Isolation resistance	$V_{IO} = 500\text{ V}$	$R_{IO}$	$\geq 10^{11}$	$\Omega$
Storage temperature range		$T_{stg}$	- 55 to + 150	°C
Ambient temperature range		$T_{amb}$	- 55 to + 110	°C
Soldering temperature	max. 10 s, dip soldering: distance to seating plane $\geq 1.5\text{ mm}$	$T_{sld}$	260	°C

## Electrical Characteristics

$T_{amb} = 25\text{ }^{\circ}\text{C}$ , unless otherwise specified

Minimum and maximum values are testing requirements. Typical values are characteristics of the device and are the result of engineering evaluation. Typical values are for information only and are not part of the testing requirements.

### Input

Parameter	Test condition	Symbol	Min	Typ.	Max	Unit
Forward voltage	$I_F = 60\text{ mA}$	$V_F$		1.25	1.65	V
Breakdown voltage	$I_R = 10\text{ }\mu\text{A}$	$V_{BR}$	6.0			V
Reserve current	$V_R = 6.0\text{ V}$	$I_R$		0.01	10	$\mu\text{A}$
Capacitance	$V_R = 0\text{ V}$ , $f = 1.0\text{ MHz}$	$C_O$		25		pF

### Output

Parameter	Test condition	Symbol	Min	Typ.	Max	Unit
Collector-emitter capacitance	$V_{CE} = 5.0\text{ V}$ , $f = 1.0\text{ MHz}$	$C_{CE}$		5.2		pF
Base - collector capacitance	$V_{CE} = 5.0\text{ V}$ , $f = 1.0\text{ MHz}$	$C_{BC}$		6.5		pF
Emitter - base capacitance	$V_{CE} = 5.0\text{ V}$ , $f = 1.0\text{ MHz}$	$C_{EB}$		7.5		pF

### Coupler

Parameter	Test condition	Part	Symbol	Min	Typ.	Max	Unit
Saturation voltage, collector-emitter	$I_F = 10\text{ mA}$ , $I_C = 2.5\text{ mA}$		$V_{CEsat}$		0.25	0.4	V
Coupling capacitance			$C_C$		0.6		pF
Collector-emitter leakage current	$V_{CE} = 10\text{ V}$	CNY117-1	$I_{CEO}$		2.0	50	nA
		CNY117-2	$I_{CEO}$		2.0	50	nA
		CNY117-3	$I_{CEO}$		5.0	100	nA
		CNY117-4	$I_{CEO}$		5.0	100	nA

### Current Transfer Ratio

Current Transfer Ratio  $I_C/I_F$  at  $V_{CE} = 5.0\text{ V}$ ,  $25\text{ }^{\circ}\text{C}$  and Collector-Emitter Leakage Current by dash number

Parameter	Test condition	Part	Symbol	Min	Typ.	Max	Unit
Current Transfer Ratio	$I_F = 10\text{ mA}$	CNY117-1	CTR	40		80	%
		CNY117-2	CTR	63		125	%
		CNY117-3	CTR	100		200	%
		CNY117-4	CTR	160		320	%
	$I_F = 1.0\text{ mA}$	CNY117-1	CTR	13	30		%
		CNY117-2	CTR	22	45		%
		CNY117-3	CTR	34	70		%
		CNY117-4	CTR	56	90		%

### Switching Characteristics

Linear operation (without saturation)

Parameter	Test condition	Symbol	Min	Typ.	Max	Unit
Turn-on time	$I_F = 10 \text{ mA}$ , $V_{CC} = 5.0 \text{ V}$ , $R_L = 75 \text{ W}$	$t_{on}$		3.0		$\mu\text{s}$
Rise time	$I_F = 10 \text{ mA}$ , $V_{CC} = 5.0 \text{ V}$ , $R_L = 75 \text{ W}$	$t_r$		2.0		$\mu\text{s}$
Turn-off time	$I_F = 10 \text{ mA}$ , $V_{CC} = 5.0 \text{ V}$ , $R_L = 75 \text{ W}$	$t_{off}$		2.3		$\mu\text{s}$
Fall time	$I_F = 10 \text{ mA}$ , $V_{CC} = 5.0 \text{ V}$ , $R_L = 75 \text{ W}$	$t_f$		2.0		$\mu\text{s}$
Cut-off frequency	$I_F = 10 \text{ mA}$ , $V_{CC} = 5.0 \text{ V}$ , $R_L = 75 \text{ W}$	$f_{CO}$		250		kHz

Switching operation (with saturation)

Parameter	Test condition	Part	Symbol	Min	Typ.	Max	Unit
Turn-on time	$I_F = 20 \text{ mA}$	CNY117-1	$t_{on}$		3.0		$\mu\text{s}$
	$I_F = 10 \text{ mA}$	CNY117-2	$t_{on}$		4.2		$\mu\text{s}$
		CNY117-3	$t_{on}$		4.2		$\mu\text{s}$
	$I_F = 5.0 \text{ mA}$	CNY117-4	$t_{on}$		6.0		$\mu\text{s}$
Rise time	$I_F = 20 \text{ mA}$	CNY117-1	$t_r$		2.0		$\mu\text{s}$
	$I_F = 10 \text{ mA}$	CNY117-2	$t_r$		3.0		$\mu\text{s}$
		CNY117-3	$t_r$		3.0		$\mu\text{s}$
	$I_F = 5.0 \text{ mA}$	CNY117-4	$t_r$		4.6		$\mu\text{s}$
Turn-off time	$I_F = 20 \text{ mA}$	CNY117-1	$t_{off}$		18		$\mu\text{s}$
	$I_F = 10 \text{ mA}$	CNY117-2	$t_{off}$		23		$\mu\text{s}$
		CNY117-3	$t_{off}$		23		$\mu\text{s}$
	$I_F = 5.0 \text{ mA}$	CNY117-4	$t_{off}$		25		$\mu\text{s}$
Fall time	$I_F = 20 \text{ mA}$	CNY117-1	$t_f$		11		$\mu\text{s}$
	$I_F = 10 \text{ mA}$	CNY117-2	$t_f$		14		$\mu\text{s}$
		CNY117-3	$t_f$		14		$\mu\text{s}$
	$I_F = 5.0 \text{ mA}$	CNY117-4	$t_f$		15		$\mu\text{s}$

### Typical Characteristics ( $T_{amb} = 25^\circ\text{C}$ unless otherwise specified)

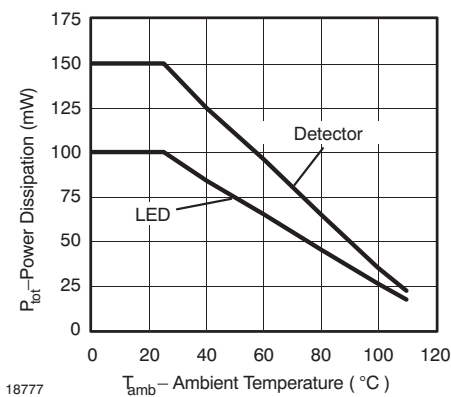

Figure 1. Permissible Power Dissipation vs. Ambient Temperature

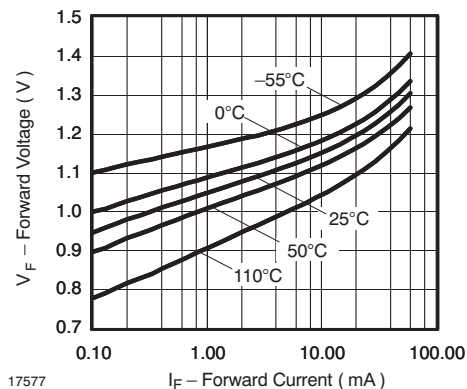

Figure 2. Forward Voltage vs. Forward Current

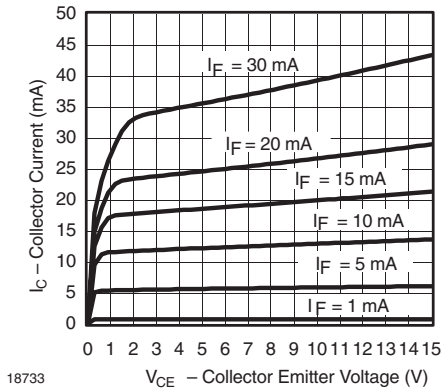

Figure 3. Collector Current vs. Collector Emitter Voltage

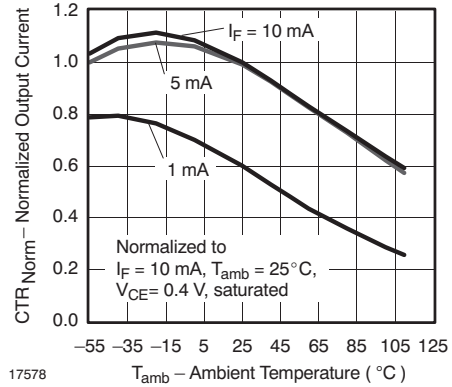

Figure 6. Normalized Current Transfer Ratio vs. Ambient Temperature

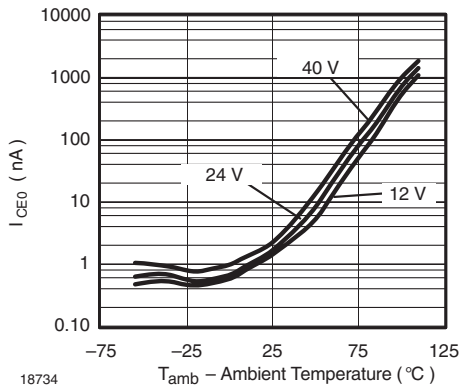

Figure 4. Collector to Emitter Dark Current vs. Ambient Temperature

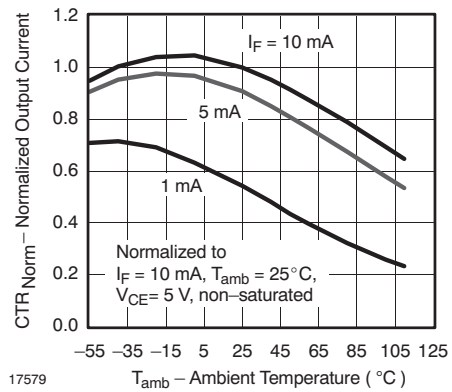

Figure 7. Normalized Current Transfer Ratio vs. Ambient Temperature

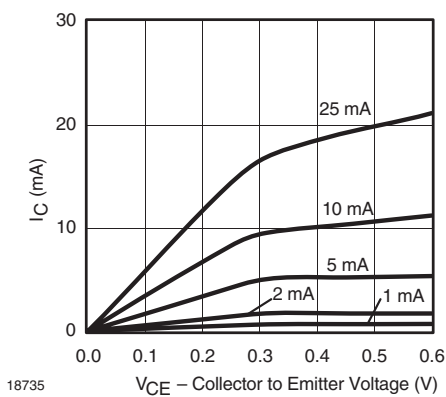

Figure 5. Normalized Current vs. Collector Emitter Saturation Voltage

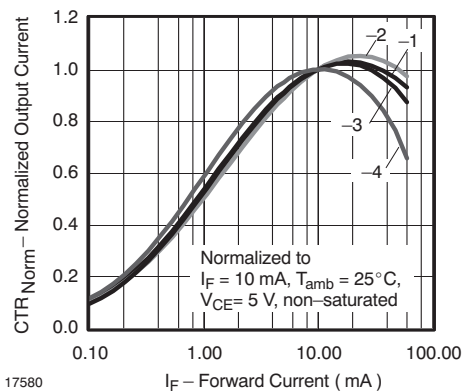

Figure 8. Normalized CTR vs. Forward Current

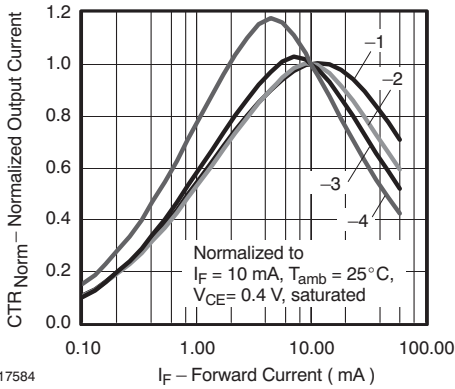

Figure 9. Normalized CTR vs. Forward Current

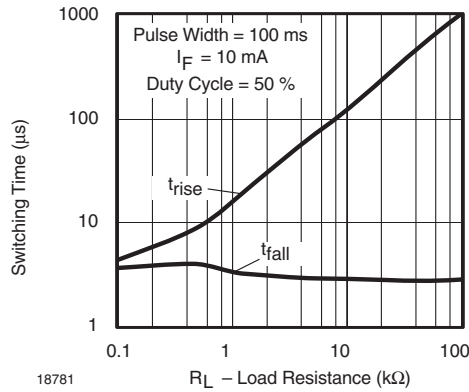

Figure 12. Time Switching vs. Load Resistance

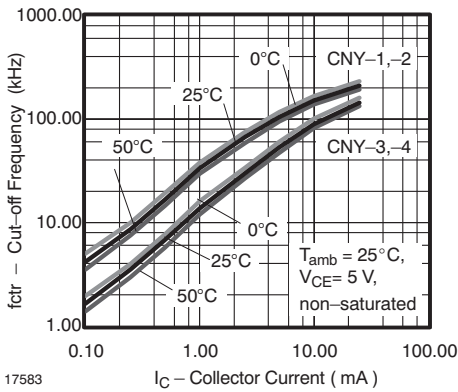

Figure 10. Cut-off Frequency vs. Collector Current

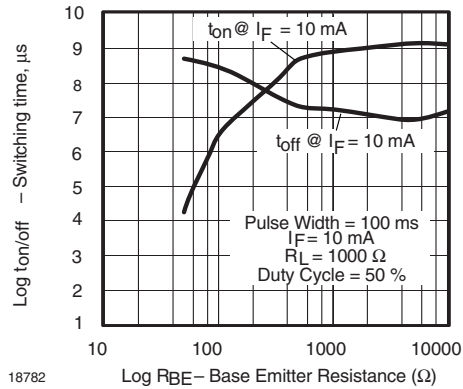

Figure 13. Switching Time vs. Base Emitter Resistance

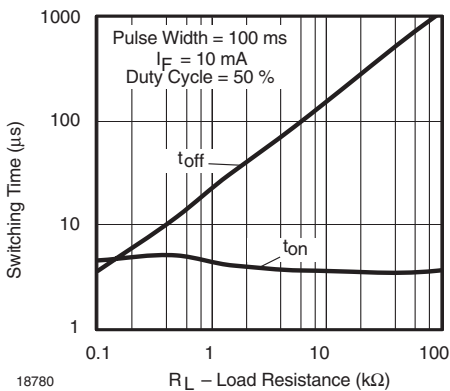

Figure 11. Time Switching vs. Load Resistance

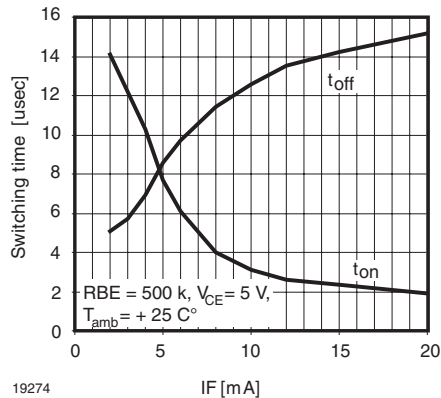
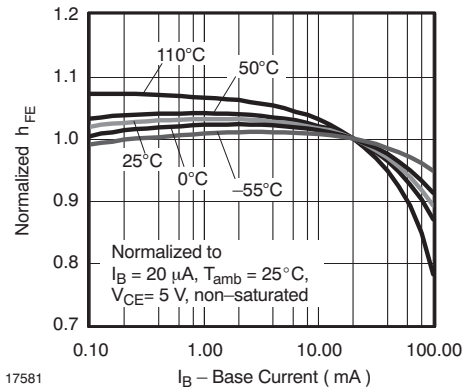
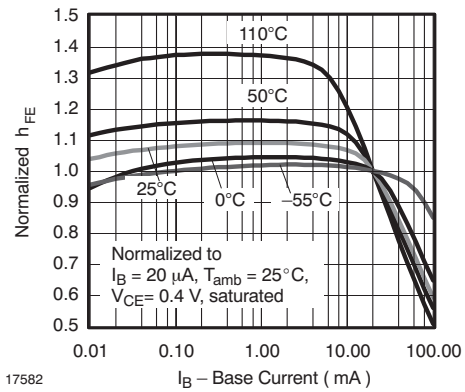

Figure 14. Switching Time vs. IF



17581

Figure 15. Normalized HFE vs. Base Current



17582

Figure 16. Normalized HFE vs. Base Current

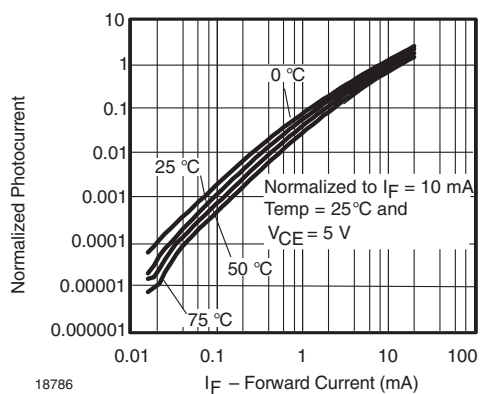

18786

Figure 17. Normalized Photocurrent vs. Forward current

### Package Dimensions in Inches (mm)

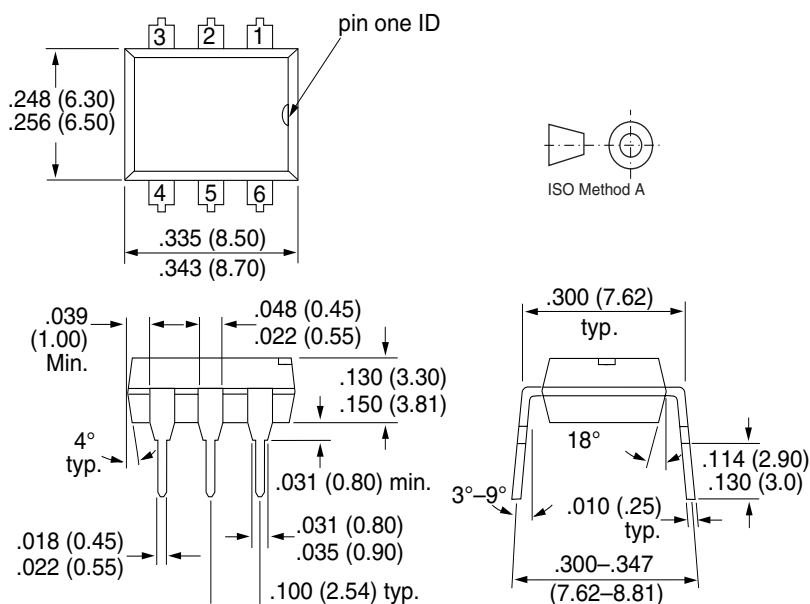

i178004



## Ozone Depleting Substances Policy Statement

It is the policy of Vishay Semiconductor GmbH to

1. Meet all present and future national and international statutory requirements.
2. Regularly and continuously improve the performance of our products, processes, distribution and operating systems with respect to their impact on the health and safety of our employees and the public, as well as their impact on the environment.

It is particular concern to control or eliminate releases of those substances into the atmosphere which are known as ozone depleting substances (ODSs).

The Montreal Protocol (1987) and its London Amendments (1990) intend to severely restrict the use of ODSs and forbid their use within the next ten years. Various national and international initiatives are pressing for an earlier ban on these substances.

Vishay Semiconductor GmbH has been able to use its policy of continuous improvements to eliminate the use of ODSs listed in the following documents.

1. Annex A, B and list of transitional substances of the Montreal Protocol and the London Amendments respectively
2. Class I and II ozone depleting substances in the Clean Air Act Amendments of 1990 by the Environmental Protection Agency (EPA) in the USA
3. Council Decision 88/540/EEC and 91/690/EEC Annex A, B and C (transitional substances) respectively.

Vishay Semiconductor GmbH can certify that our semiconductors are not manufactured with ozone depleting substances and do not contain such substances.

We reserve the right to make changes to improve technical design and may do so without further notice.

Parameters can vary in different applications. All operating parameters must be validated for each customer application by the customer. Should the buyer use Vishay Semiconductors products for any unintended or unauthorized application, the buyer shall indemnify Vishay Semiconductors against all claims, costs, damages, and expenses, arising out of, directly or indirectly, any claim of personal damage, injury or death associated with such unintended or unauthorized use.

Vishay Semiconductor GmbH, P.O.B. 3535, D-74025 Heilbronn, Germany  
Telephone: 49 (0)7131 67 2831, Fax number: 49 (0)7131 67 2423



---

**Notice**

Specifications of the products displayed herein are subject to change without notice. Vishay Intertechnology, Inc., or anyone on its behalf, assumes no responsibility or liability for any errors or inaccuracies.

Information contained herein is intended to provide a product description only. No license, express or implied, by estoppel or otherwise, to any intellectual property rights is granted by this document. Except as provided in Vishay's terms and conditions of sale for such products, Vishay assumes no liability whatsoever, and disclaims any express or implied warranty, relating to sale and/or use of Vishay products including liability or warranties relating to fitness for a particular purpose, merchantability, or infringement of any patent, copyright, or other intellectual property right.

The products shown herein are not designed for use in medical, life-saving, or life-sustaining applications. Customers using or selling these products for use in such applications do so at their own risk and agree to fully indemnify Vishay for any damages resulting from such improper use or sale.