

UNCONTROLLED DOCUMENT

PART NUMBER  
SML-LXL3055SYC-TR

REV.

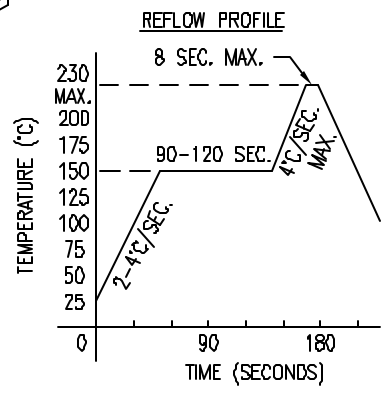
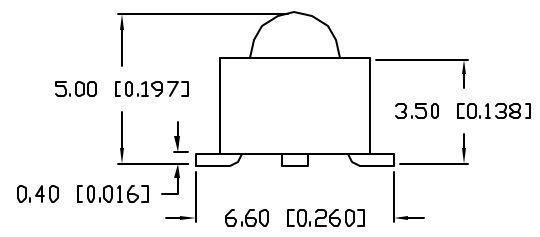
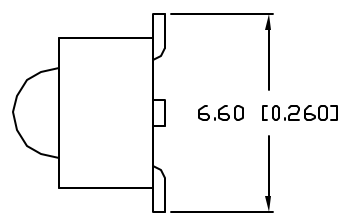
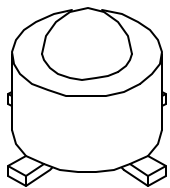
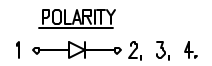
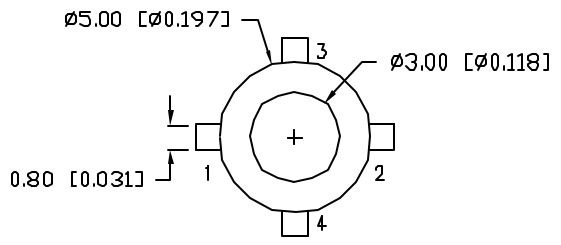

ELECTRO-OPTICAL CHARACTERISTICS  $T_A=25^\circ\text{C}$   $I_f=20\text{mA}$

| PARAMETER          | MIN         | TYP | MAX | UNITS    | TEST COND            |
|--------------------|-------------|-----|-----|----------|----------------------|
| PEAK WAVELENGTH    |             | 590 |     | nm       |                      |
| FORWARD VOLTAGE    |             | 2.0 | 2.8 | $V_f$    |                      |
| REVERSE VOLTAGE    | 5.0         |     |     | $V_r$    | $I_f=100\mu\text{A}$ |
| AXIAL INTENSITY    |             | 300 |     | mcd      | $I_f=20\text{mA}$    |
| VIEWING ANGLE      |             | 30  |     | 2x theta |                      |
| EMITTED COLOR:     | YELLOW      |     |     |          |                      |
| EPOXY LENS FINISH: | WATER CLEAR |     |     |          |                      |

LIMITS OF SAFE OPERATION AT 25°C

| PARAMETER                | MAX        | UNITS |
|--------------------------|------------|-------|
| PEAK FORWARD CURRENT*    | 150        | mA    |
| STEADY CURRENT           | 30         | mA    |
| POWER DISSIPATION        | 105        | mW    |
| DERATE FROM 25°C         | -1.2       | mW/°C |
| OPERATING, STORAGE TEMP. | -40 TO +85 | °C    |

\*  $t < 10\mu\text{s}$

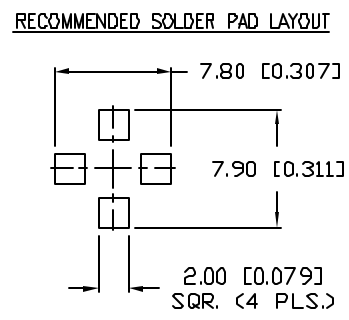
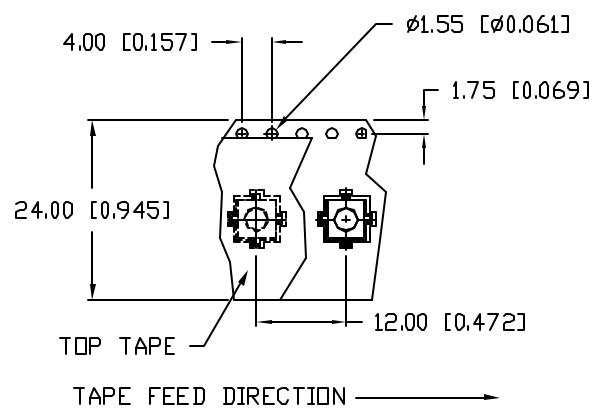

- NOTES:
- 500 PIECES PER REEL
  - PIN #2 IS ORIENTED TOWARD THE TAPE SPROCKET HOLE.

\*UNLESS OTHERWISE SPECIFIED TOLERANCES PER DECIMAL PRECISION ARE: X=±1 (±0.039), XX=±0.5 (±0.020), XXX=±0.25 (±0.010), XXXX=±0.127 (±0.005). LEAD SIZE=±0.05 (±0.002), LEAD LENGTH=±0.75 (±0.030). MIN= +DECIMAL PRECISION -0.00 MAX.= +0.00 -DECIMAL PRECISION

UNCONTROLLED DOCUMENT

REV. PART NUMBER  
SML-LXL3055SYC-TR

CONFIDENTIAL INFORMATION  
THE INFORMATION CONTAINED IN THIS DOCUMENT IS THE PROPERTY OF LUMEX INC. EXCEPT AS SPECIFICALLY AUTHORIZED IN WRITING BY LUMEX INC., THE HOLDER OF THIS DOCUMENT SHALL KEEP ALL INFORMATION CONTAINED HEREIN CONFIDENTIAL AND SHALL PROTECT SAME IN WHOLE OR IN PART FROM DISCLOSURE AND DISSEMINATION TO ALL THIRD PARTIES.



290 E. HELEN ROAD  
PALATINE, IL 60067-6976  
PHONE: +1.847.359.2790  
US WEB: www.lumex.com  
TW WEB: www.lumex.com.tw

T-5mm (T-1 3/4) SURFACE MOUNT LED,  
4 LEADED, 3mm DOME, TAPE AND REEL,  
590nm SUPER YELLOW CHIP, WATER CLEAR LENS.

RELIABILITY NOTE  
OUR MANY YEARS OF EXPERIENCE DATA ACCUMULATION INDICATE THAT SOLDER HEAT IS A MAJOR CAUSE OF EARLY AND FUTURE FAILURE. PLEASE PAY ATTENTION TO YOUR SOLDERING PROCESS.

DRAWN BY: CT  
CHECKED BY:  
APPROVED BY:  
DATE: 5.2.02  
PAGE: 1 OF 1  
SCALE: N/A