

A Unit of Teledyne Electronics and Communications

CENTIGRID® ESTABLISHED RELIABILITY RELAYS SENSITIVE DPDT

SERIES 134

SERIES DESIGNATION	RELAY TYPE
134	DPDT basic relay
134D	DPDT relay with internal diode for coil transient suppression
134DD	DPDT relay with internal diodes for coil transient suppression and polarity reversal protection

INTERNAL CONSTRUCTION

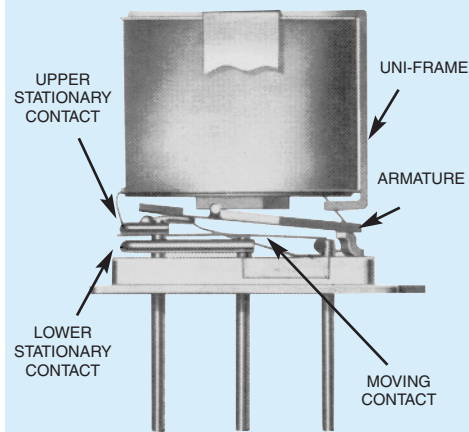

DESCRIPTION

The 134 sensitive Centigrid® relay retains the same features as the 114 standard Centigrid® relay with only a minimal increase in profile height (.375 in.). Its .100-inch grid spaced terminals, which preclude the need for spreader pads, and its low profile make the 134 relay ideal for applications where high packaging density is important.

The following unique construction features and manufacturing techniques provide excellent resistance to environmental extremes and overall high reliability:

- All welded construction.
- Unique uni-frame design providing high magnetic efficiency and mechanical rigidity.
- High force/mass ratios for resistance to shock and vibration.
- Advanced cleaning techniques provide maximum assurance of internal cleanliness.
- Precious metal alloy contact material with gold plating assures excellent high current and dry circuit switching capabilities.

The Series 134D and 134DD have internal discrete silicon diodes for coil suppression and polarity reversal protection.

The sensitive 134 Centigrid® relay has a high resistance coil, thus requiring extremely low operating power (200 mw typical). The advantages of reduced heat dissipation and power supply demands are a plus.

By virtue of its inherently low intercontact capacitance and contact circuit losses, the 134 relay has proven to be an excellent ultraminiature RF switch for frequency ranges well into the UHF spectrum. A typical RF application for the Centigrid® relay is in handheld radio transceivers, wherein the combined features of good RF performance, small size, low coil power dissipation and high reliability make it a preferred method of Transmit-Receive switching (see Figure 1).

ENVIRONMENTAL AND PHYSICAL SPECIFICATIONS

Temperature (Ambient)	-65°C to +125°C
Vibration (General Note 1)	30 g's to 3000 Hz
Shock (General Note 1)	75 g's, 6 msec, half-sine
Acceleration	50 g's
Enclosure	Hermetically sealed
Weight	0.15 oz. (4.3g) max.

SERIES 134
GENERAL ELECTRICAL SPECIFICATIONS (-65°C to +125°C unless otherwise noted) (Notes 2 & 3)

Contact Arrangement	2 Form C (DPDT)	
Rated Duty	Continuous	
Contact Resistance	0.1 ohm max. before life; 0.2 ohm max. after life at 1A/28Vdc (measured 1/8" from header)	
Contact Load Ratings (DC) (See Fig. 2 for other DC resistive voltage/current ratings)	Resistive: 1 Amp/28Vdc Inductive: 200 mA/28Vdc (320 mH) Lamp: 100 mA/28Vdc Low Level: 10 to 50 μ A/10 to 50mV	
Contact Load Ratings (AC)	Resistive: 250 mA/115Vac, 60 and 400 Hz (Case not grounded) 100 mA/115Vac, 60 and 400 Hz (Case grounded)	
Contact Life Ratings	10,000,000 cycles (typical) at low level 1,000,000 cycles (typical) at 0.5A/28Vdc resistive 100,000 cycles min. at all other loads specified above	
Contact Overload Rating	2A/28Vdc Resistive (100 cycles min.)	
Contact Carry Rating	Contact factory	
Coil Operating Power	200 milliwatts typical at nominal rated voltage @ 25°C	
Operate Time	4.0 msec max. at nominal rated coil voltage	
Release Time	134 Series: 2.0 msec max. 134D, 134DD Series: 7.5 msec max.	
Contact Bounce	1.5 msec max.	
Intercontact Capacitance	0.4 pf typical	
Insulation Resistance	10,000 megohms min. between mutually isolated terminals	
Dielectric Strength	Atmospheric pressure: 500 Vrms/60Hz	70,000 ft.: 125 Vrms/60Hz
Negative Coil Transient (Vdc)	134D, 134DD	1.0 max
Diode P.I.V. (Vdc)	134D, 134DD	100 min.

DETAILED ELECTRICAL SPECIFICATIONS (-65°C to +125°C unless otherwise noted) (Note 3)

	BASE PART NUMBERS (See Note 8 for full P/N example)	➔	134-5	134-6	134-9	134-12	134-18	134-26
			134D-5 134DD-5	134D-6 134DD-6	134D-9 134DD-9	134D-12 134DD-12	134D-18 134DD-18	134D-26 134DD-26
Coil Voltage (Vdc)	Nom.		5.0	6.0	9.0	12.0	18.0	26.5
	Max.		7.5	10.0	15.0	20.0	30.0	40.0
Coil Resistance (Ohms \pm10% @25°C)	134, 134D		100	200	400	800	1600	3200
	134DD (Note 4)		64	125	400	800	1600	3200
Coil Current (mA_{dc} @25°C) (134DD Series)	Min.		56.8	36.3	18.1	12.5	9.6	7.2
	Max.		78.1	48.9	23.6	16.0	12.2	9.0
Pick-up Voltage (Vdc, Max.)	134, 134D		3.5	4.5	6.8	9.0	13.5	18.0
	134DD		3.7	4.8	8.0	11.0	14.5	19.0
Drop-out Voltage (Vdc)	134, 134D	Min.	0.12	0.18	0.35	0.41	0.59	0.89
		Max.	2.5	3.2	4.9	6.5	10.0	13.0
	134DD	Min.	0.7	0.8	0.9	1.0	1.1	1.3
		Max.	2.6	3.0	4.5	5.8	9.0	13.0

PERFORMANCE CURVES
(NOTE 2)

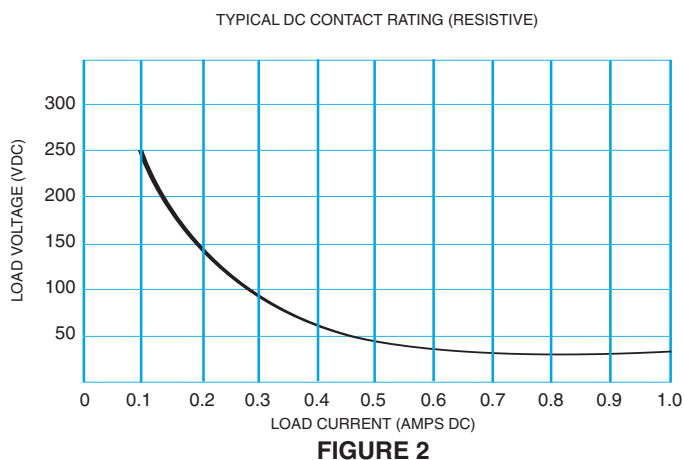
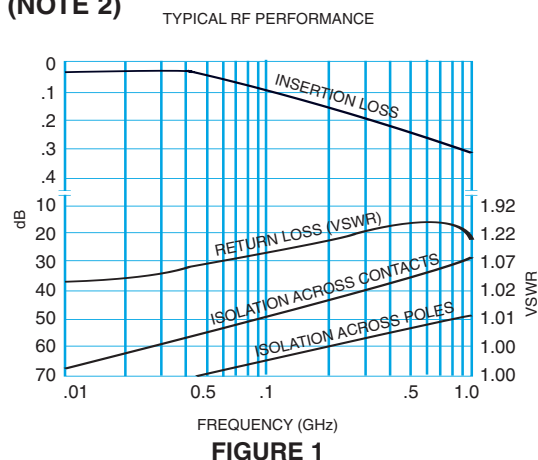

SERIES 134

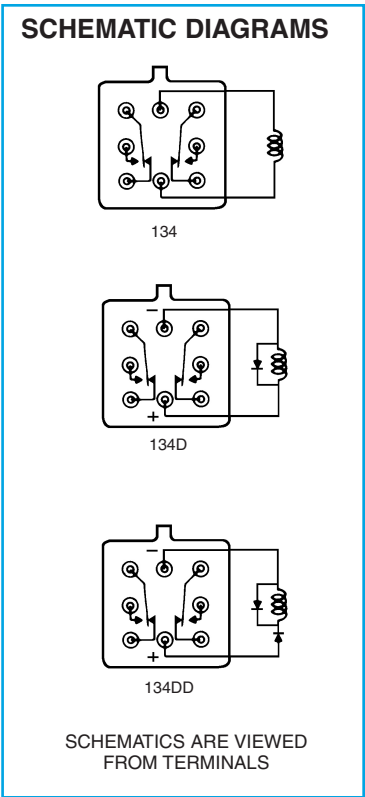
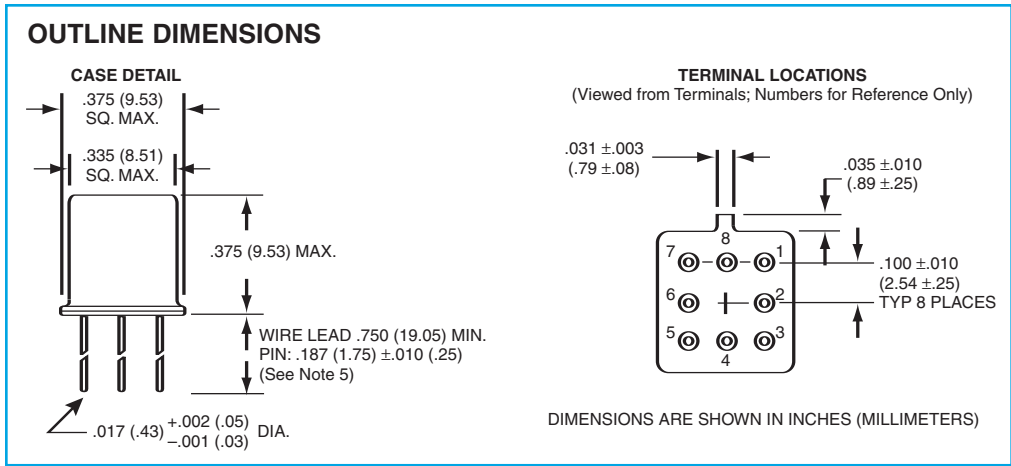

GENERAL NOTES

1. Relay contacts will exhibit no chatter in excess of 10 μsec or transfer in excess of 1 μsec.
2. "Typical" characteristics are based on available data and are best estimates. No on-going verification tests are performed.
3. Unless otherwise specified, parameters are initial values.
4. For reference only. Coil resistance not directly measurable at relay terminals due to internal series diode in 134DD only.
5. Unless otherwise specified, relays will be supplied with either gold-plated or solder-coated leads.
6. The slash and characters appearing after the slash are not marked on the relay.
7. Screened HI-REL versions available. Contact factory.
- 8.

ESTABLISHED RELIABILITY

Teledyne Part Numbering System for T²R[®] Established Reliability Relay

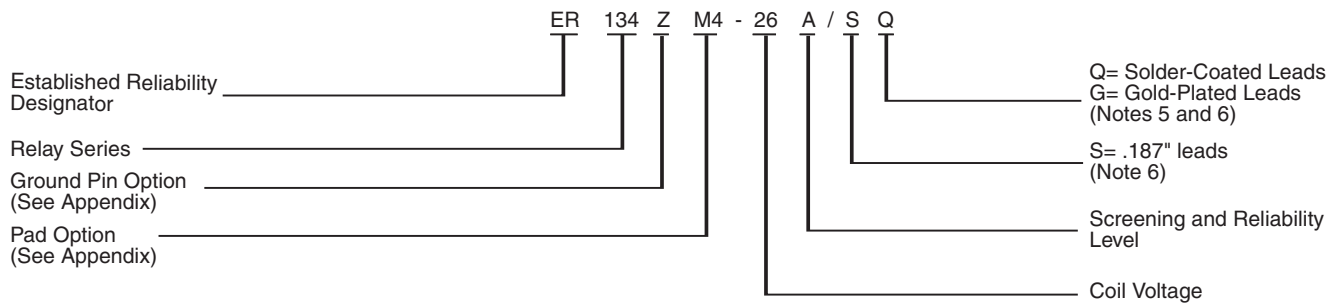

Teledyne Part Numbering System for Military Qualified (JAN) Relays

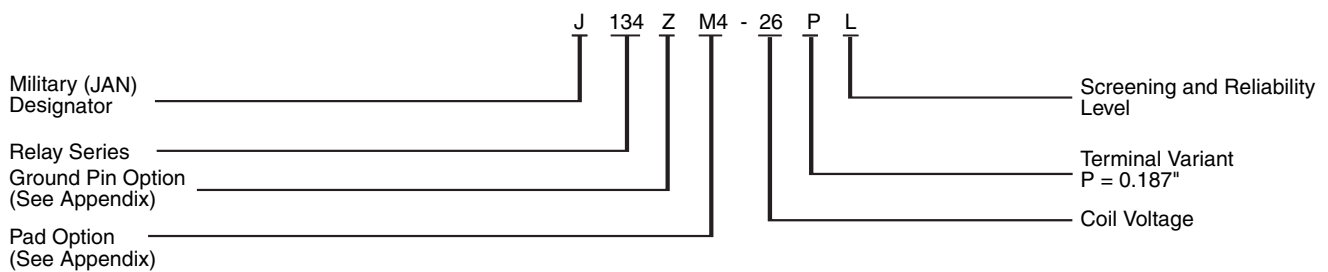

Spacer Pads

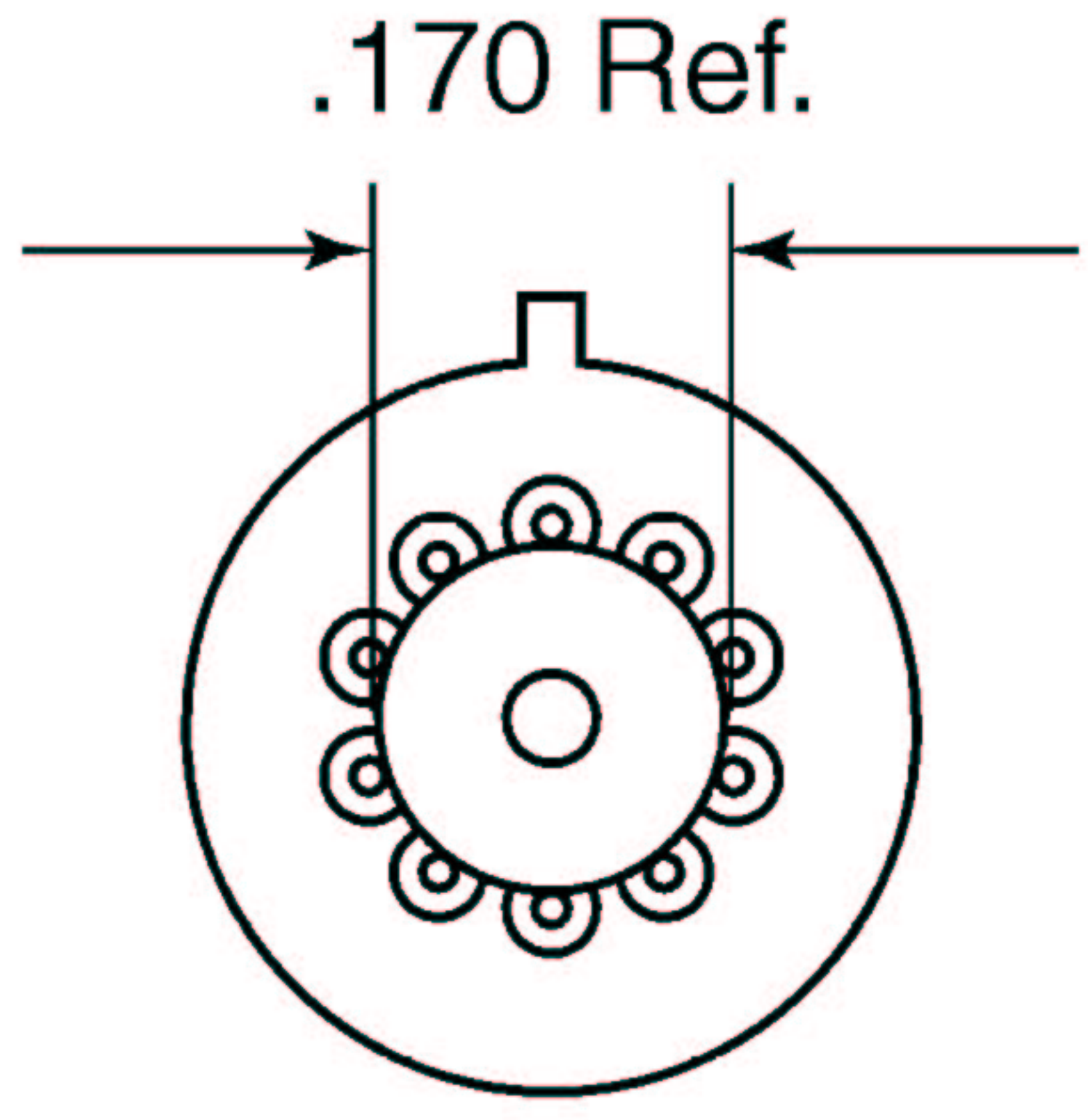
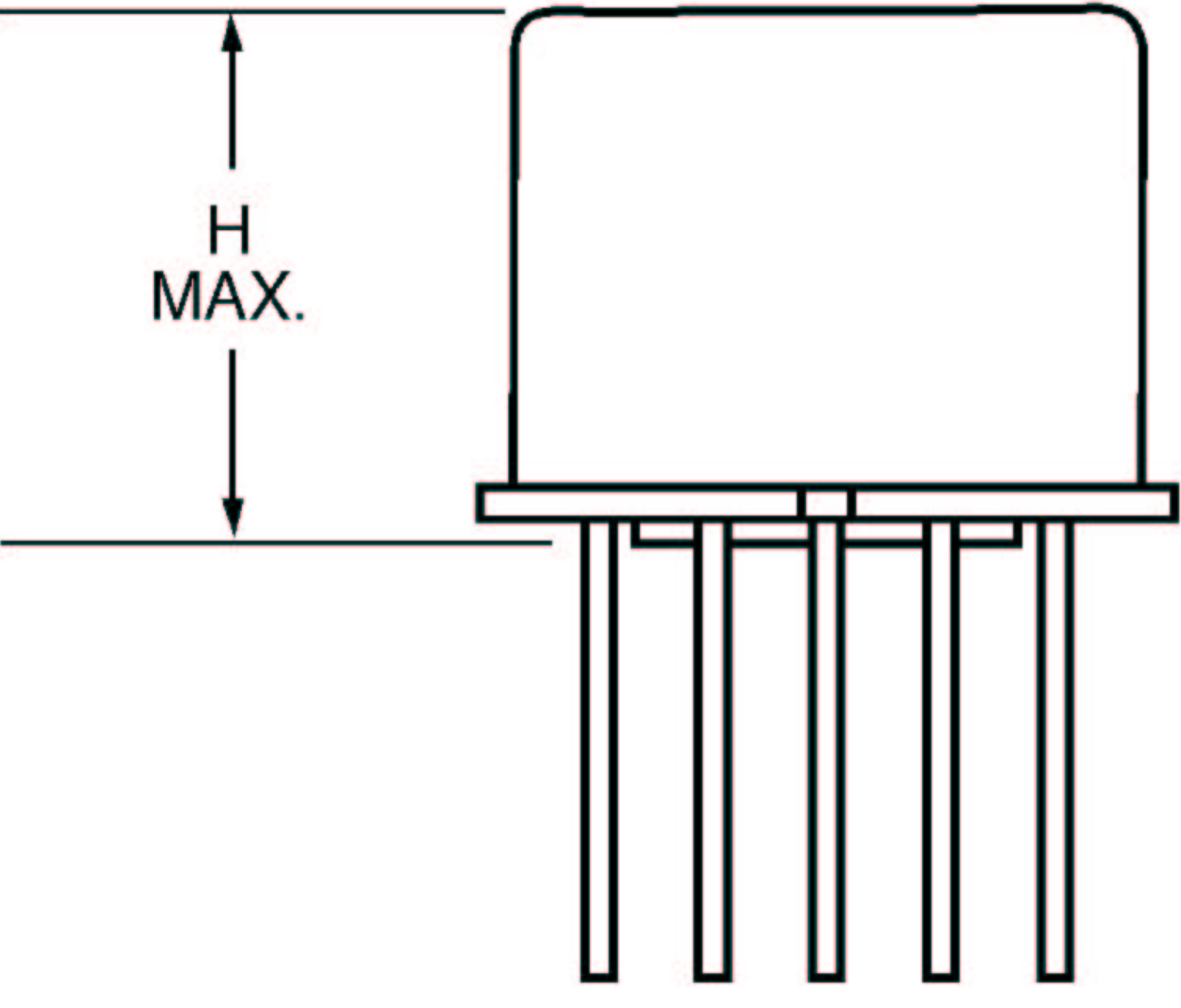
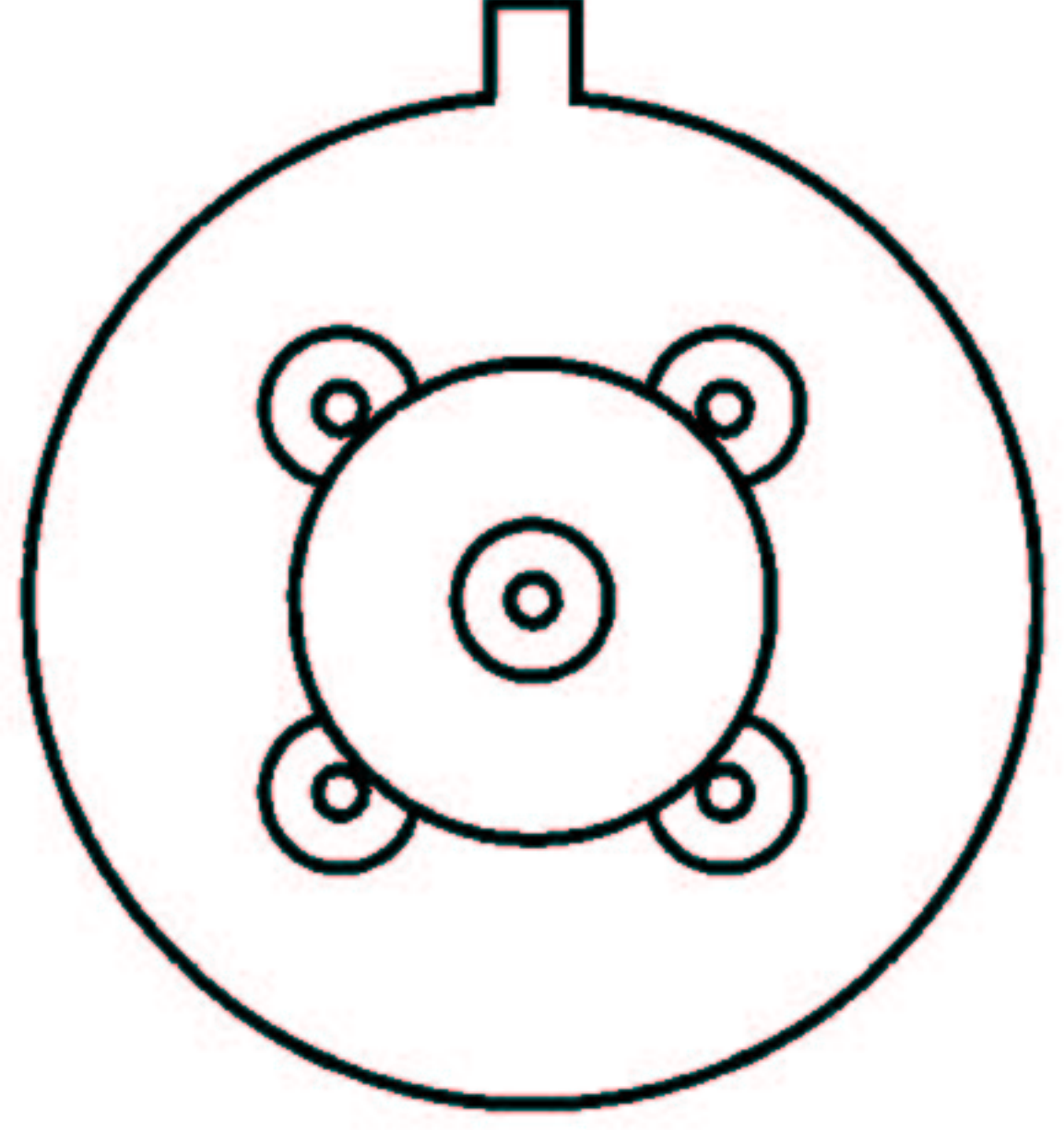
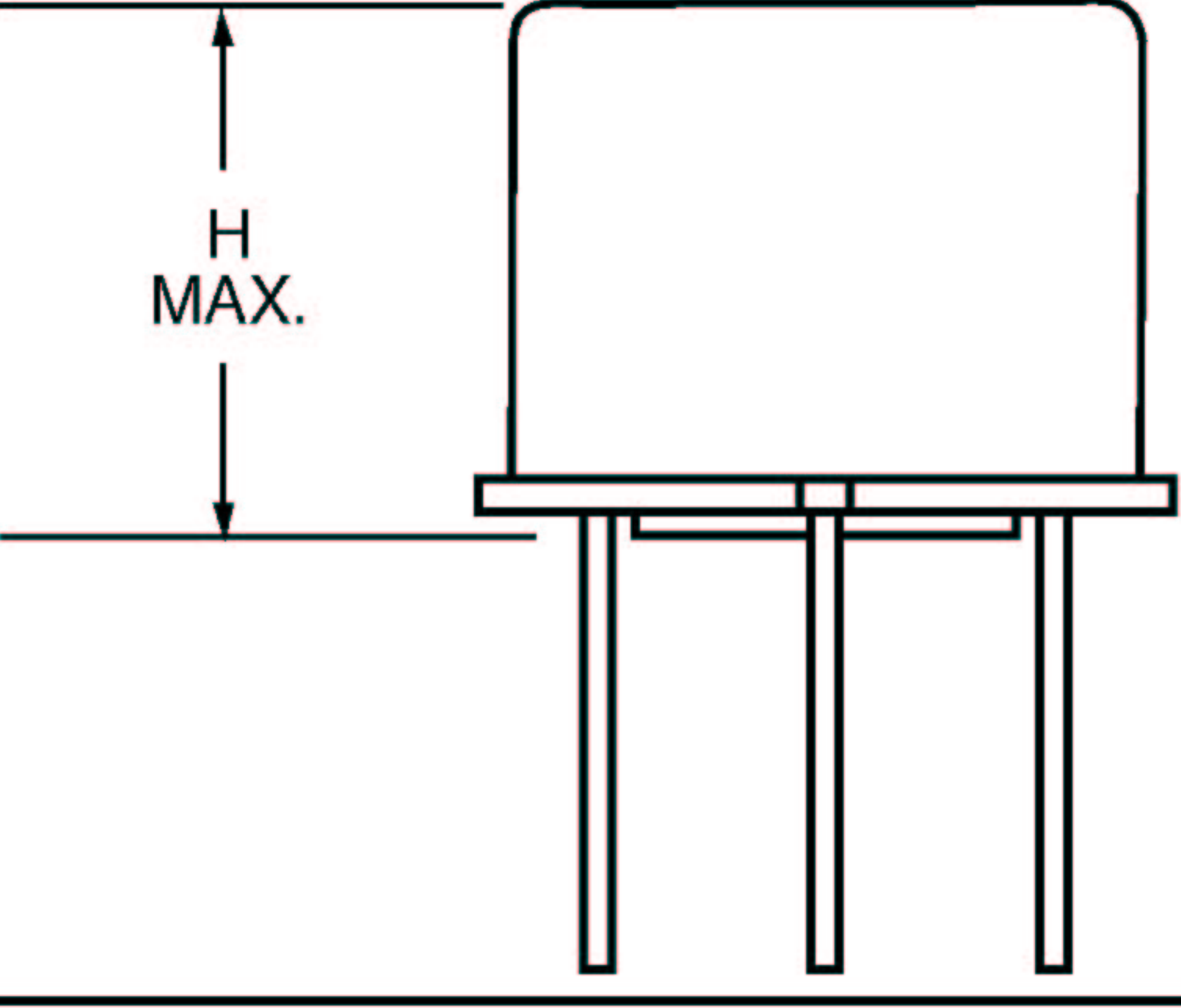
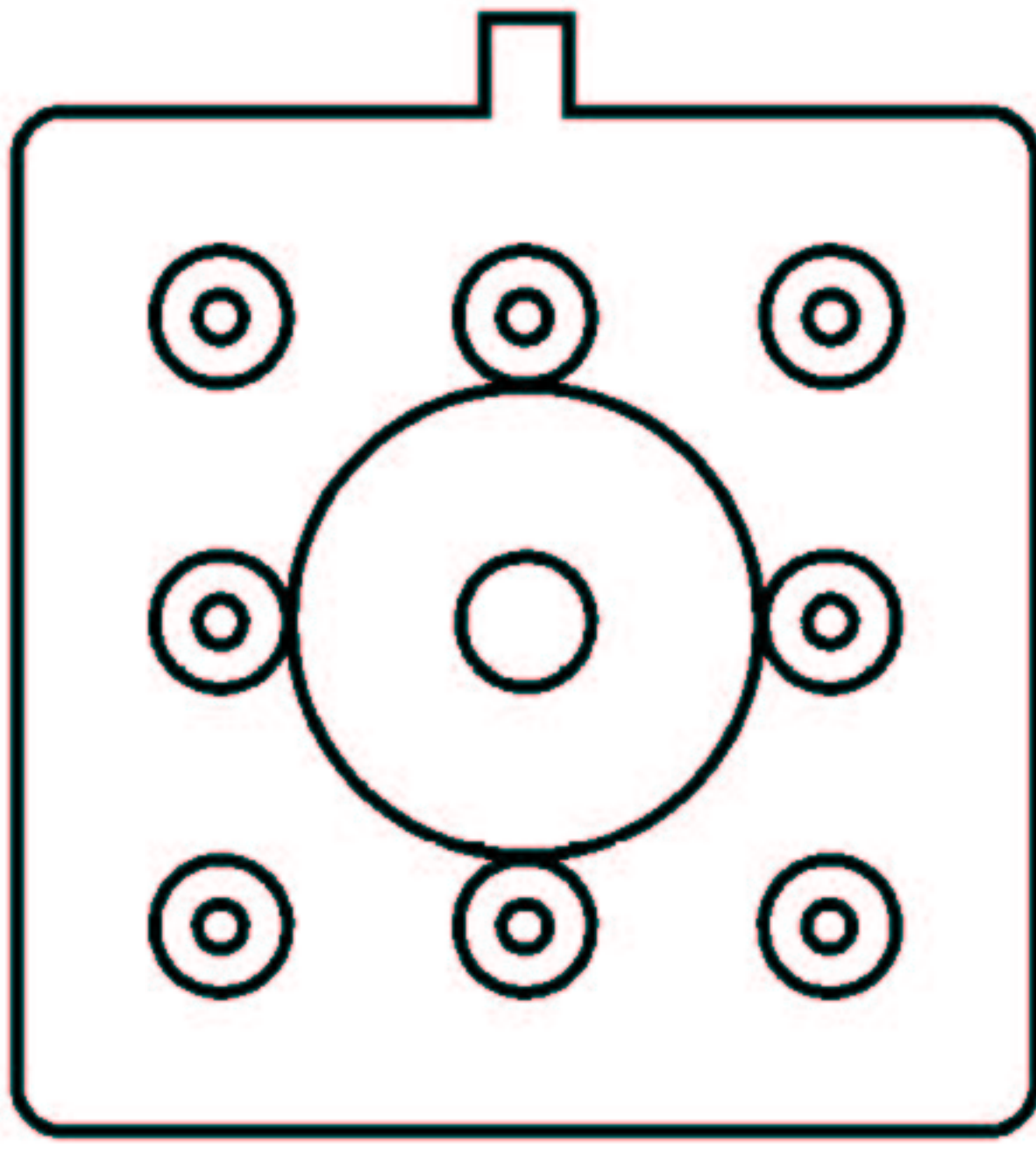
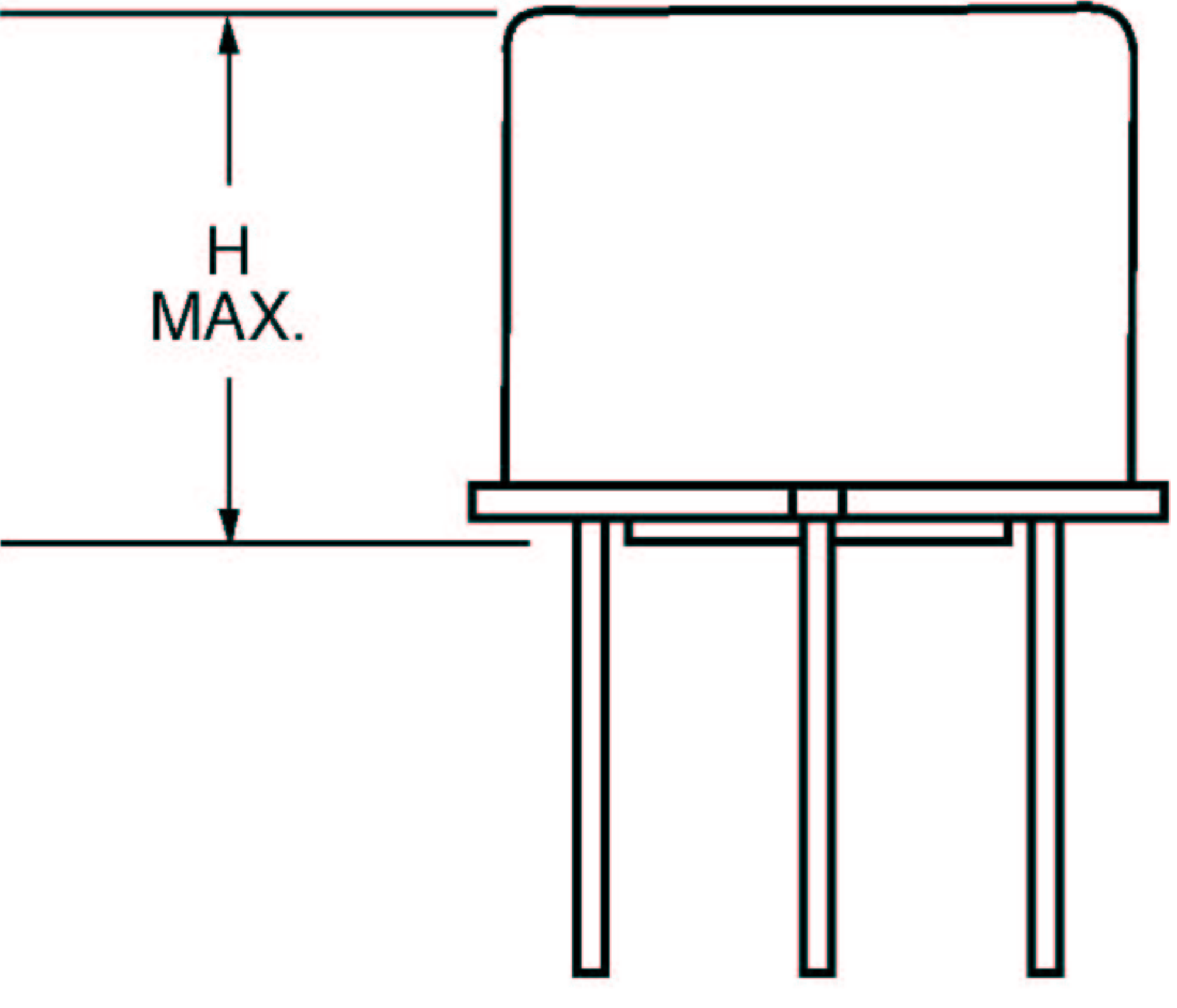
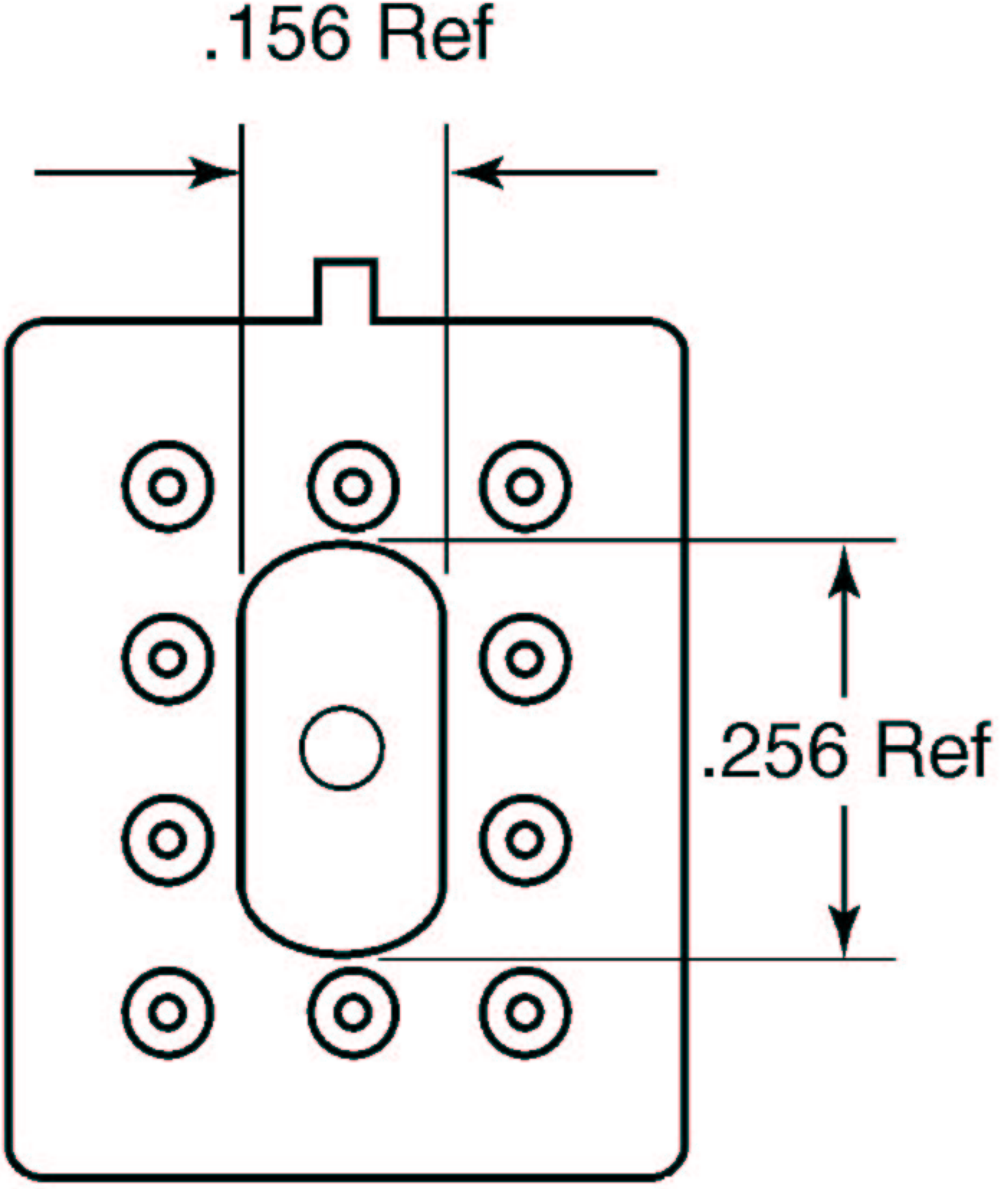
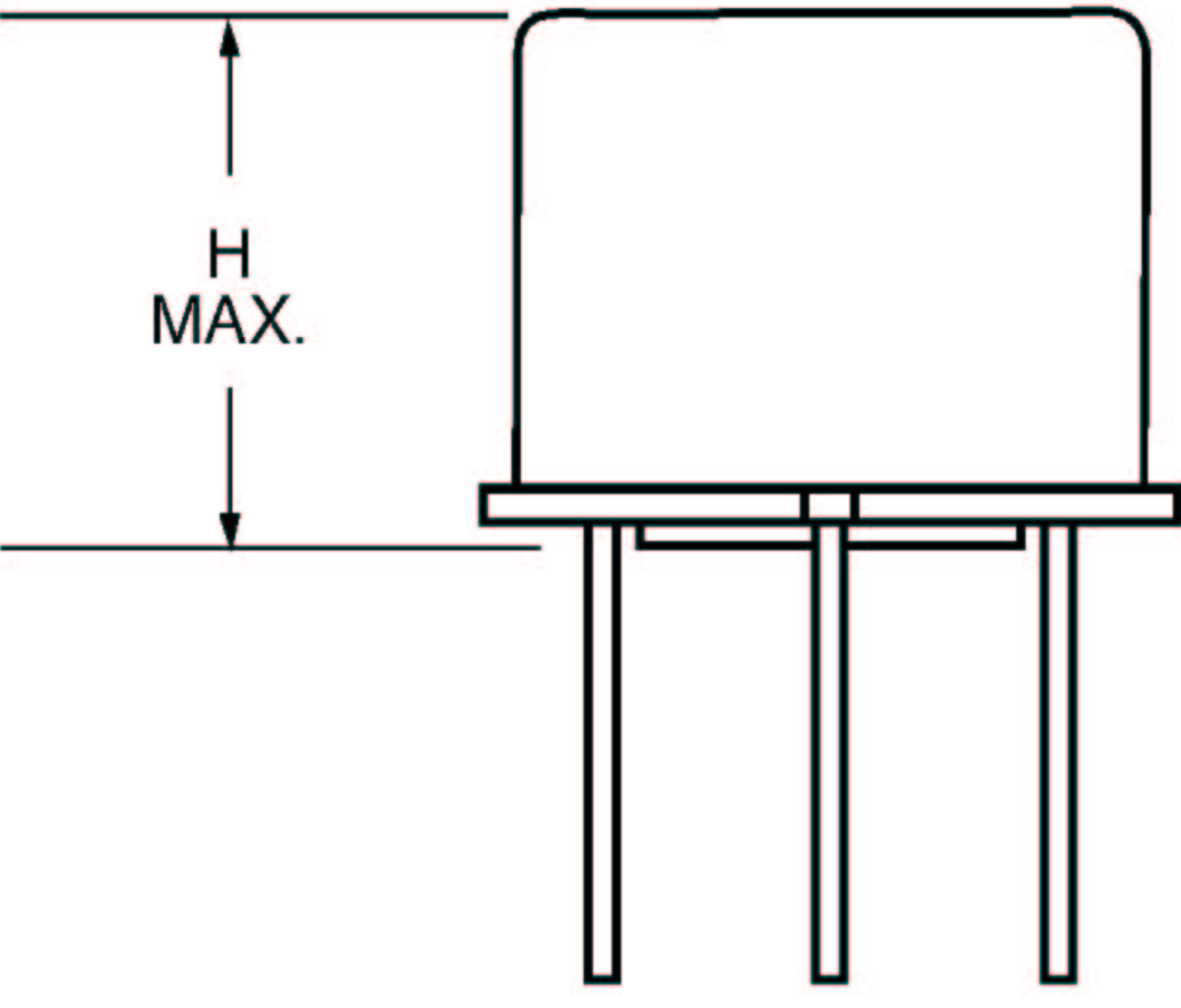
Pad designation and bottom view dimensions	Height	For use with the following relays	Dim. H Max
 <p>“M4” Pad for TO-5</p>		ER411T ER412, ER412D, ER412DD ER412T	.295 (7.49)
		712, 712D, 712TN	.300 (7.62)
		ER420, ER420D, ER420DD, ER421, ER421D, ER421DD, ER422, ER422D ER422DD, 722, 722D	.305 (7.75)
		ER431T ER432, ER432D, ER432DD ER432T	.400 (10.16)
		732, 732D, 732TN	.410 (10.41)
 <p>“M4” Pad for TO-5</p>		ER411, ER411D, ER411DD	.295 (7.49)
		ER431, ER431D, ER431DD	.400 (10.16)
 <p>“M4” Pad for Centigrid®</p>		172, 172D	/28 low profile .305 (7.75) high profile .405 (10.29)
		ER114, ER114D, ER114DD J114, J114D, J114DD	.300 (7.62)
		ER134, ER134D, ER134DD J134, J134D, J134DD	.400 (10.16)
 <p>“M9” Pad for Centigrid®</p>		122C	.320 (8.13)
		ER116C, J116C	.300 (7.62)
		ER1363C, J136C	.400 (10.16)

NOTES:

1. Spacer pad material: Polyester film.
2. To specify an “M4” or “M9” spacer pad, refer to the mounting variants portion of the part number example in the applicable data sheet.
3. Dimensions are in inches (mm).
4. Unless otherwise specified, tolerance is .010 (.25).
5. Add 10mΩ to the contact resistance shown in the data sheet.
6. Add .01 oz. (.25g) to the weight of the relay assembly shown in the data sheet.

Spreader Pads

Spreader pads are provided as a lead configuration option

Pad designation and bottom view dimensions	Height and lead length	Use with the following relays	Dim. H Max.
<p>"M" Pad 5/ 6/</p>		ER411T, J411T, ER412, ER412D, ER412DD, J412, J412D, J412DD, ER412T, J412T	.388 (9.86)
		712, 712D, 712TN	.393 (9.99)
		ER431T, J431T, ER432, ER432D, ER432DD, J432, J432D, J432DD, ER432T, J432T	.493 (12.52)
		732, 732D, 732TN	.503 (12.78)
		ER420, J420, ER420D, J420D, ER420DD, J420DD, ER421, J421, ER421D, J421D, ER421DD, J421DD, ER422, J422, ER422D, J422D, ER422DD, J422DD, 722	.398 (10.11)
<p>"M2" Pad 7/ 8/</p>		ER411T ER412, ER412D, ER412DD J412, J412D, J412DD	.441 (11.20)
		712, 712D	.451 (11.46)
		ER421, ER421D, ER421DD 722, 722DD	.451 (11.46)
		ER431T ER432, ER432D, ER432DD	.546 (13.87)
<p>"M3" Pad 5/ 6/ 9/</p>		ER411, ER411D, ER411DD ER411TX ER412X, ER412DX, ER412DDX ER412TX	.388 (9.86)
		712X, 712DX, 712TNX	.393 (9.99)
		ER420X, ER420DX, ER420DDX ER421X, ER421DX, ER421DDX ER422X, ER422DX, ER422DDX, 722X, 722DDX	.398 (10.11)
		ER431, ER431D, ER431DD ER431TX ER432X, ER432DX, ER432DDX ER432TX	.493 (12.52)
		732X, 732DX, 732TNX	.503 (12.78)

NOTES:

1. Spreader pad material: Diallyl Phthalate.
2. To specify an "M," "M2" or "M3" spreader pad, refer to the mounting variants portion of the part number example in the applicable data sheet.
3. Dimensions are in inches (mm).
4. Unless otherwise specified, tolerance is .010 (.25)
5. Add 25mΩ to the contact resistance shown in the data sheet.
6. Add .01 oz. (.25g) to the weight of the relay assembly shown in the data sheet.
7. Add 50mΩ to the contact resistance shown in the data sheet.
8. Add .025 oz. (.71g) to the weight of the relay assembly shown in the data sheet.
9. M3 pad to be used only when the relay has a center pin (e.g. ER411M3-12A, 722XM3-26).

APPENDIX

Ground Pin Positions

Centigrid® Relays: RF100, RF103, ER114, ER134, 172

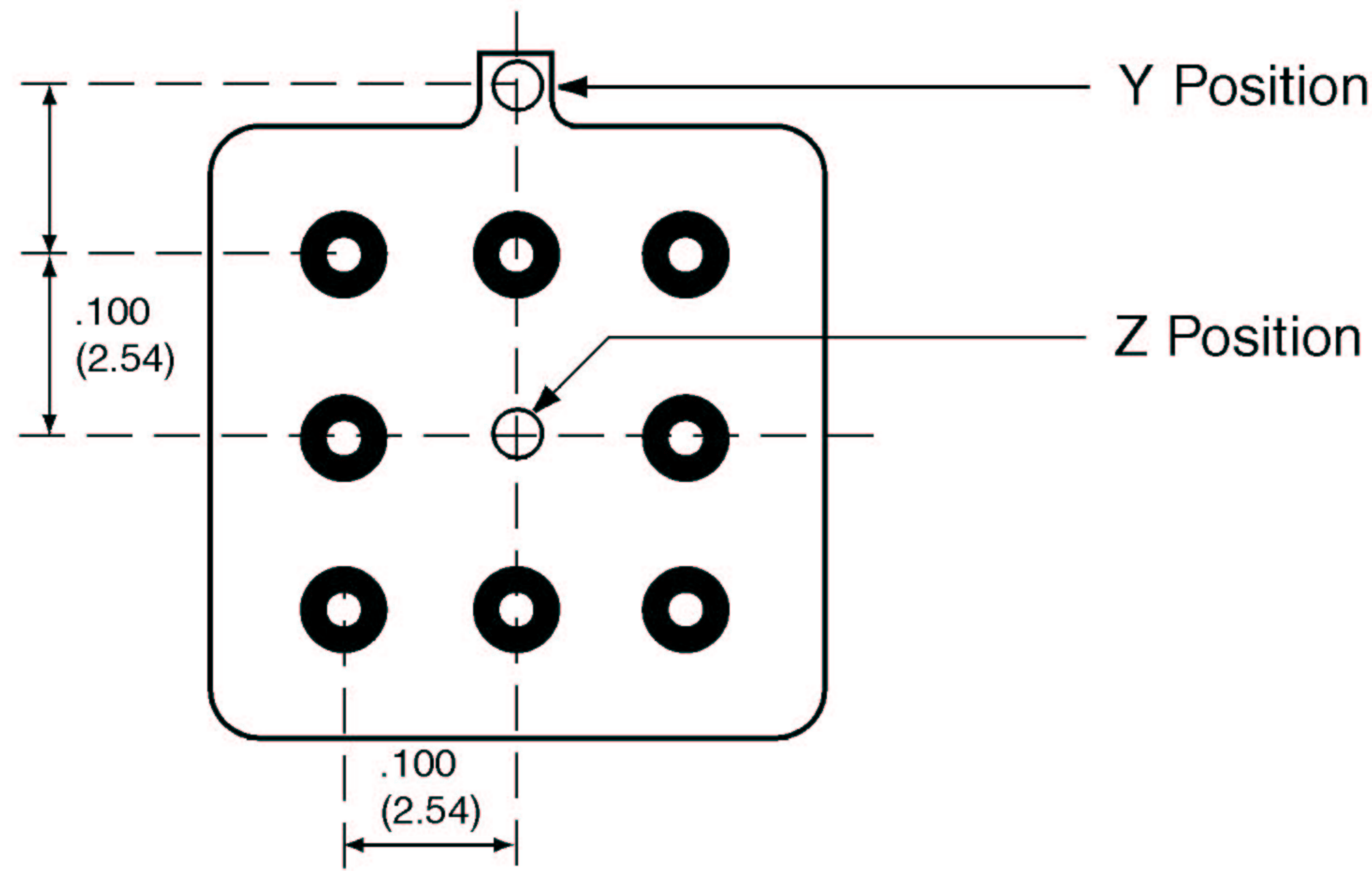

Centigrid® Relays: RF180, ER116C, 122C, ER136C

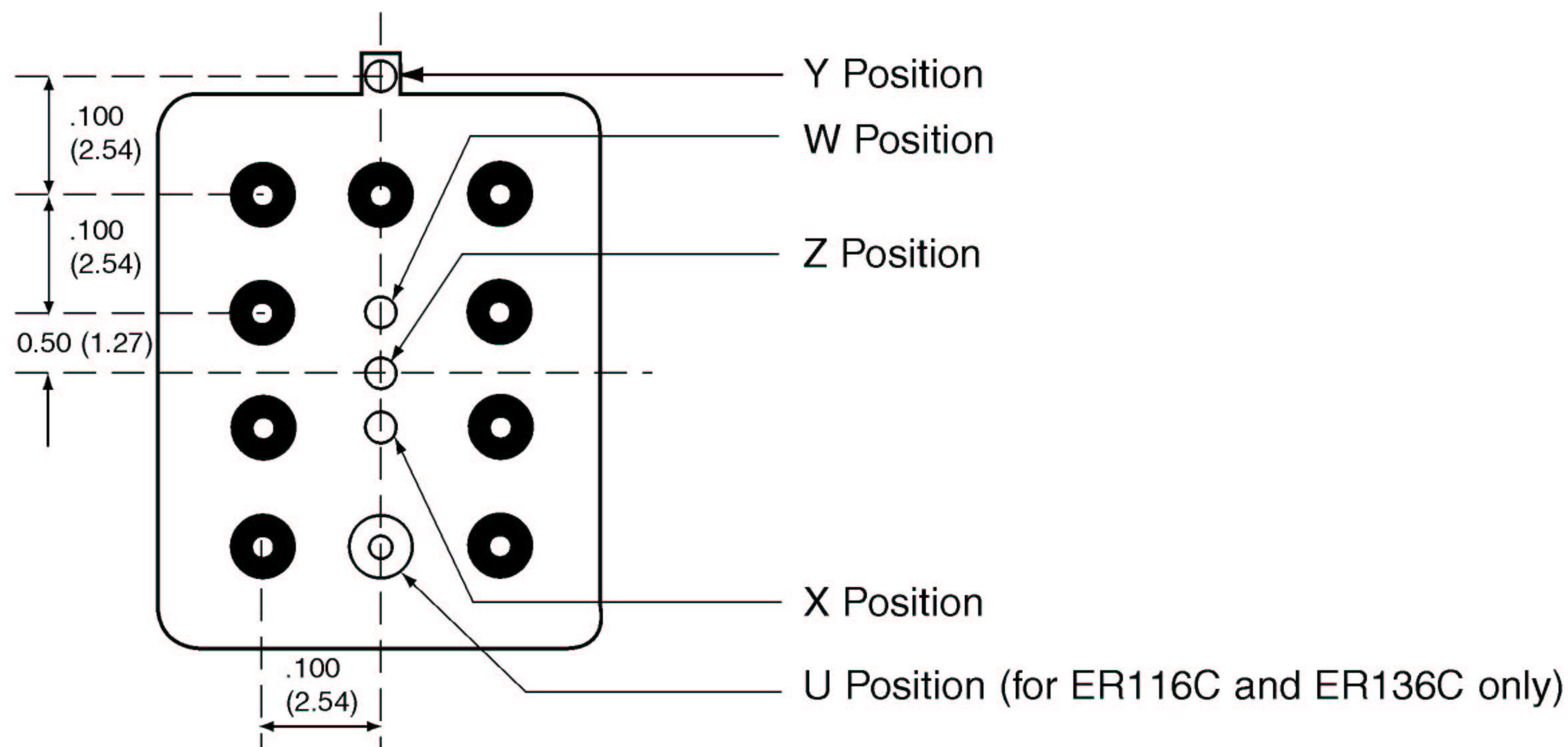

TO-5 Relays: ER411T, ER412, ER412T, ER420, ER421, ER422, ER431T, ER432, ER432T, 712, 712TN, 400H, 400K, 400V, RF300, RF303, RF341

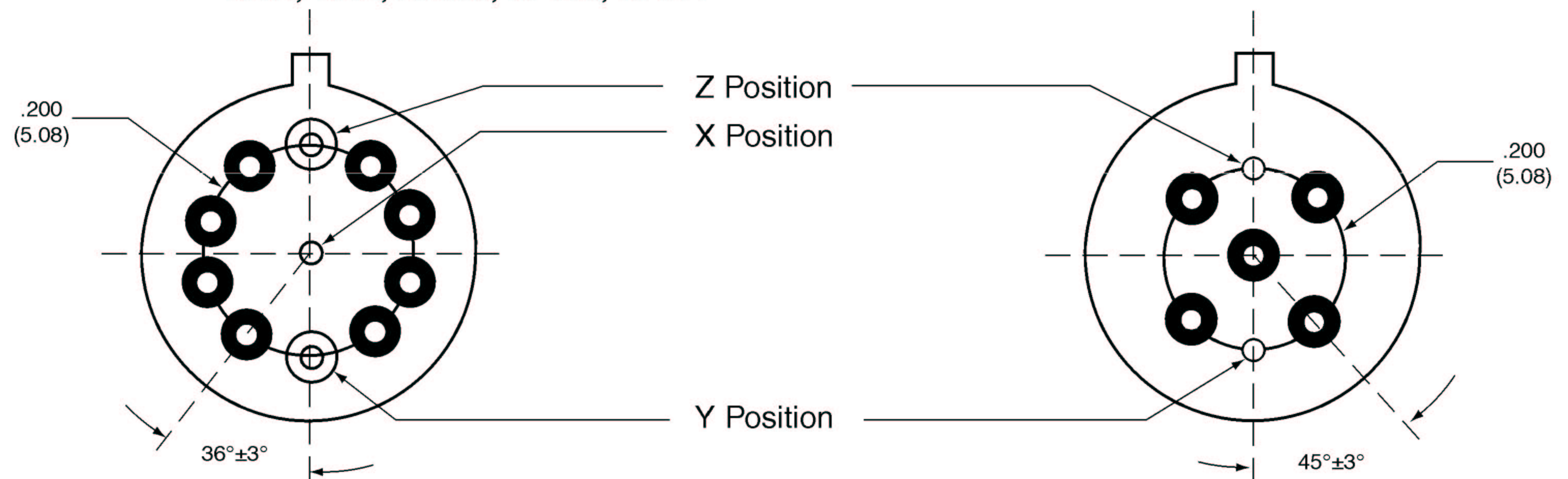

- Indicates ground pin position
- Indicates glass insulated lead position
- ◎ Indicates ground pin or lead position depending on relay type

NOTES

1. Terminal views shown.
2. Dimensions are in inches (millimeters)
3. Tolerances: ± 0.010 (± 0.25) unless otherwise specified
4. Ground pin positions are within 0.015 (0.38) dia. of true position
5. Ground pin head dia., 0.035 (0.89) ref: height 0.010 (0.25) ref.
6. Lead dia. 0.017 (0.43) nom.

Teledyne Relays Part Numbering System

RF Attenuator Relays

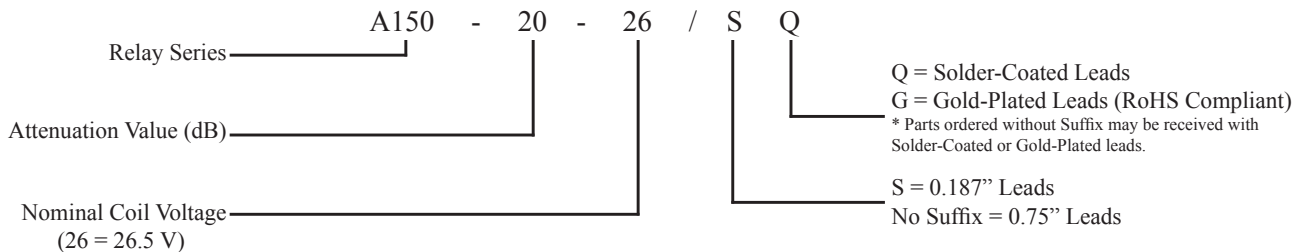

RF Relays

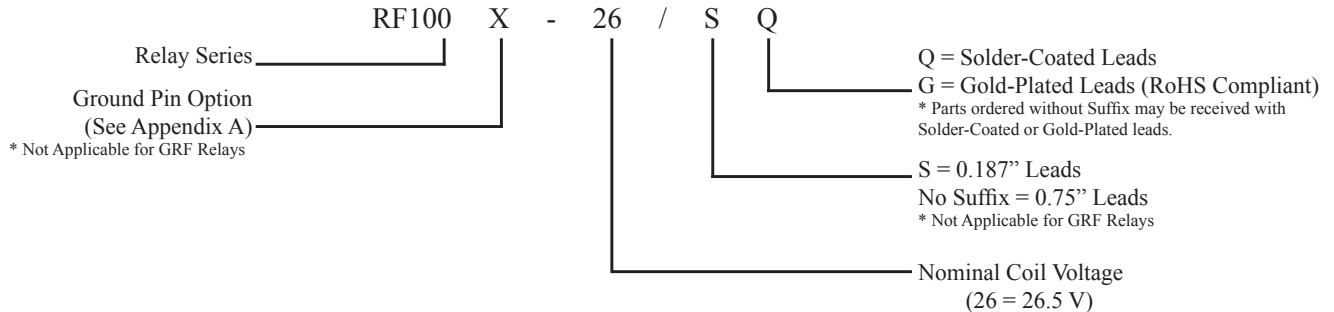

T²R Established Reliability Relays

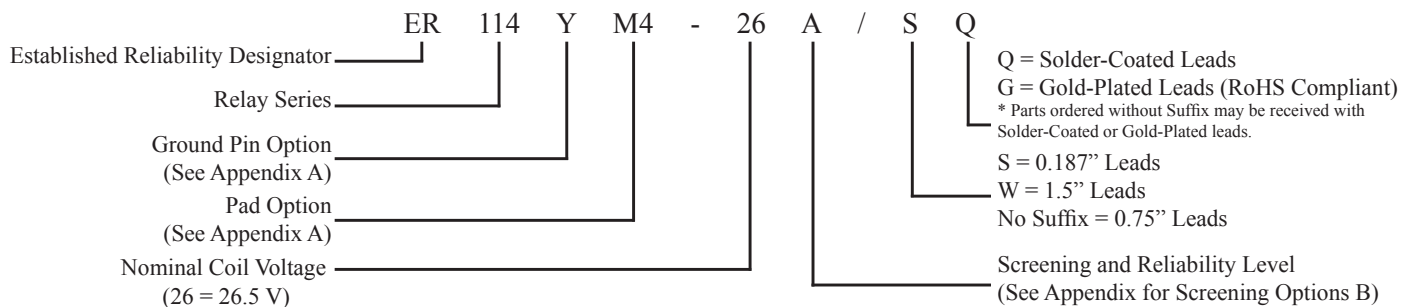

Military Qualified (JAN) Relays

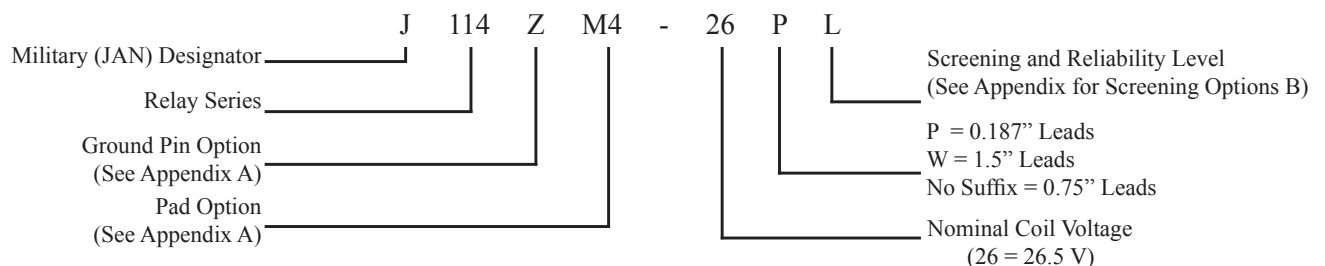

Appendix B: Teledyne Relays T²R Program

SCREENING LEVELS				
INSPECTION	Applicable To			
	<i>T²R</i> A Level 1.5%/10K Cycles	<i>T²R</i> B Level .75%/10K Cycles	JAN L Level 3%/10K Cycles	JAN M Level 1%/10K Cycles
Subgroup 1				
Screening, Internal Moisture AQL	*	*	*	*
Vibration (Sinusoidal) AQL			*	
Vibration (Sinusoidal) 100%		*		*
Screening, Burn-In (Hybrids only)		*	*	*
Screening, Run-In (Room Temperature)	*			
Screening, Run-In (+125°C and -65°C)		*	*	*
Subgroup 2				
Coil Resistance or Coil Current	*	*	*	*
Insulation Resistance	*	*	*	*
Dielectric Withstanding Voltage	*	*	*	*
Static Contact Resistance	*	*	*	*
Pickup and Dropout or Set and Reset Voltage	*	*	*	*
Operate and Release or Set and Reset Time	*	*	*	*
Hold Voltage			*	*
Turn-On and Turn-Off Time (Hybrids only)	*	*	*	*
Contact Bounce Time	*		*	
Contact Stabilization Time		*		*
Turn-On Current (T Hybrids only)	*	*	*	*
Turn-On voltage (C Hybrids only)	*	*	*	*
Turn-Off Voltage (Hybrids only)	*	*	*	*
Coil Transient Suppression (D, DD and Hybrids only)	*	*	*	*
Diode Blocking Integrity (DD only)	*	*	*	*
Zener Voltage (C Hybrid only)	*	*	*	*
Neutral Screen (Latching Relays only)	*	*	*	*
Break Before Make Verification			*	*
Contact Simultaneity			*	*
Subgroup 3				
Solderability 2 Samples per Daily Solderability Inspection Lot	*	*	*	*
Leak Test	*	*	*	*
External Visual and Mechanical Inspection 2/Lot for Dimension and Weight Check	*	*	*	*