

Title	<i>Engineering Prototype Report for EP-73 - 2.3 W CV/CC Charger/Adapter Using LinkSwitch® -HF (LNK354P)</i>
Specification	85-265 VAC Input, 5.7 V, 400 mA Output
Application	Low Cost Charger or Adapter
Author	Power Integrations Applications Department
Document Number	EPR-73
Date	25-Oct-04
Revision	1.0

Summary and Features

- Low cost, low component count battery charger or adapter solution
- No-load power consumption <300 mW at 265 VAC input meets worldwide energy conservation guidelines
- Output voltage (CV) tolerance: $\pm 10\%$ across operating range
- Output current (CC) tolerance: $\pm 12\%$ across operating range
- Meets EN550022 and CISPR-22 Class B EMI with low value Y1 safety capacitor
- Ultra-low leakage current: <10 μA at 265 VAC input

The products and applications illustrated herein (including circuits external to the products and transformer construction) may be covered by one or more U.S. and foreign patents or potentially by pending U.S. and foreign patent applications assigned to Power Integrations. A complete list of Power Integrations' patents may be found at www.powerint.com.

Table Of Contents

1	Introduction.....	3
2	Power Supply Specification	4
3	Schematic.....	6
4	Circuit Description	7
4.1	Input EMI Filtering	7
4.2	<i>LinkSwitch-HF</i> Primary.....	7
4.3	Output Rectification	7
4.4	Output Feedback.....	7
4.5	Design Aspects for EMI.....	8
5	PCB Layout	9
6	Bill Of Materials	10
7	Transformer Specification.....	11
7.1	Electrical Diagram	11
7.2	Electrical Specifications.....	11
7.3	Materials.....	11
7.4	Transformer Build Diagram	12
7.5	Transformer Construction.....	12
8	Transformer Design Spreadsheet.....	13
9	Performance Data	16
9.1	Efficiency.....	16
9.2	No-load Input Power.....	17
9.3	Regulation	17
9.3.1	CV and CC Output Characteristics.....	17
9.3.2	Load Regulation in CV	18
10	Thermal Performance	19
11	Line Surge.....	20
12	Waveforms.....	21
12.1	Drain Voltage and Current, Normal Operation.....	21
12.2	Output Voltage Start-up Profile.....	22
12.3	Drain Voltage and Current Start-up Profile	22
12.4	Load Transient Response (75% to 100% Load Step)	23
12.5	Output Ripple Measurements.....	24
12.5.1	Ripple Measurement Technique	24
12.5.2	Measurement Results	25
13	Conducted EMI	26
13.1	115 VAC Input, Full Load	26
13.2	230 VAC Input, Full Load	27
14	Appendix A.....	28
15	Revision History.....	33

Important Note:

Although this board is designed to satisfy safety isolation requirements, the engineering prototype has not been agency approved. Therefore, all testing should be performed using an isolation transformer to provide the AC input to the prototype board.

1 Introduction

This document is an engineering report describing a 5.7 V, 400 mA power supply utilizing a LNK354P device. This power supply is intended as a general purpose evaluation platform for *LinkSwitch-HF* devices in a battery charger application with secondary side CV/CC control.

The document contains the power supply specification, schematic, bill of materials, transformer documentation, printed circuit layout, and performance data.

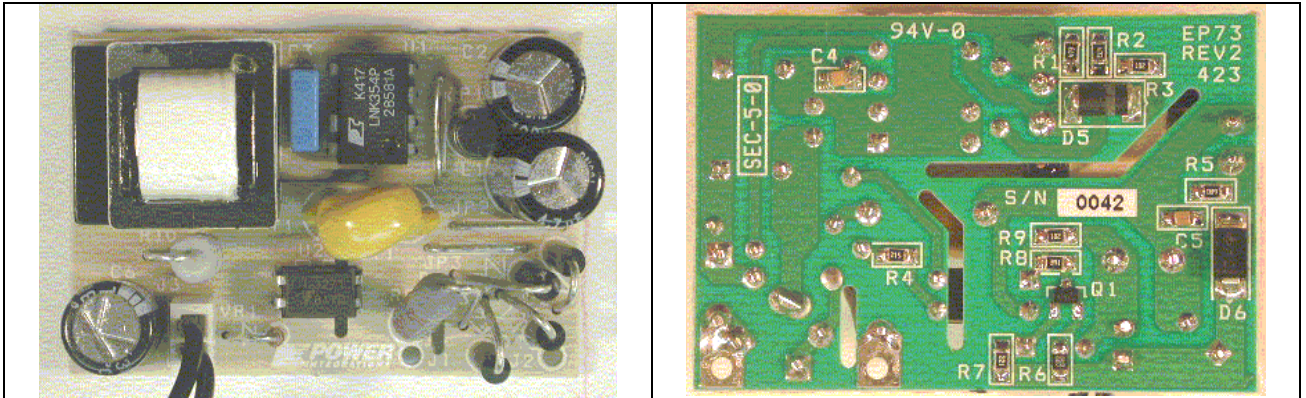

Figure 1 – EP73 Populated Circuit Board Photograph.

2 Power Supply Specification

Description	Symbol	Min	Typ	Max	Units	Comment
Input						
Voltage	V_{IN}	85		265	VAC	2 Wire – no P.E.
Frequency	f_{LINE}	47	50/60	64	Hz	
No-load Input Power (230 VAC)				0.3	W	
Output						
Output Voltage 1	V_{OUT1}	5.2	5.7	6.3	V	± 5% 20 MHz bandwidth With battery model attached to end of output cable, measured at 25 °C
Output Ripple Voltage 1	$V_{RIPPLE1}$			100	mV	
Output Current 1	I_{OUT1}	350	400	450	mA	
Total Output Power						
Continuous Output Power	P_{OUT}	1.82	2.3	2.8*	W	
Efficiency	η	55			%	Measured at P_{OUT} (1.8 W), 230 VAC, 25 °C
Environmental						
Conducted EMI		Meets CISPR22B / EN55022B				> 6 dB Margin
Safety		Designed to meet IEC950, UL1950 Class II				
Surge		2			kV	1.2/50 μ s surge, IEC 1000-4-5, Series Impedance: Differential Mode: 2 Ω Common Mode: 12 Ω
Surge		2			kV	100 kHz ring wave, 500 A short circuit current, differential and common mode
Ambient Temperature	T_{AMB}	0		50	°C	Free convection, sea level

* Maximum output power of the LNK354 is restricted by enclosure size – higher powers are possible with larger enclosures and PCB heatsink area.

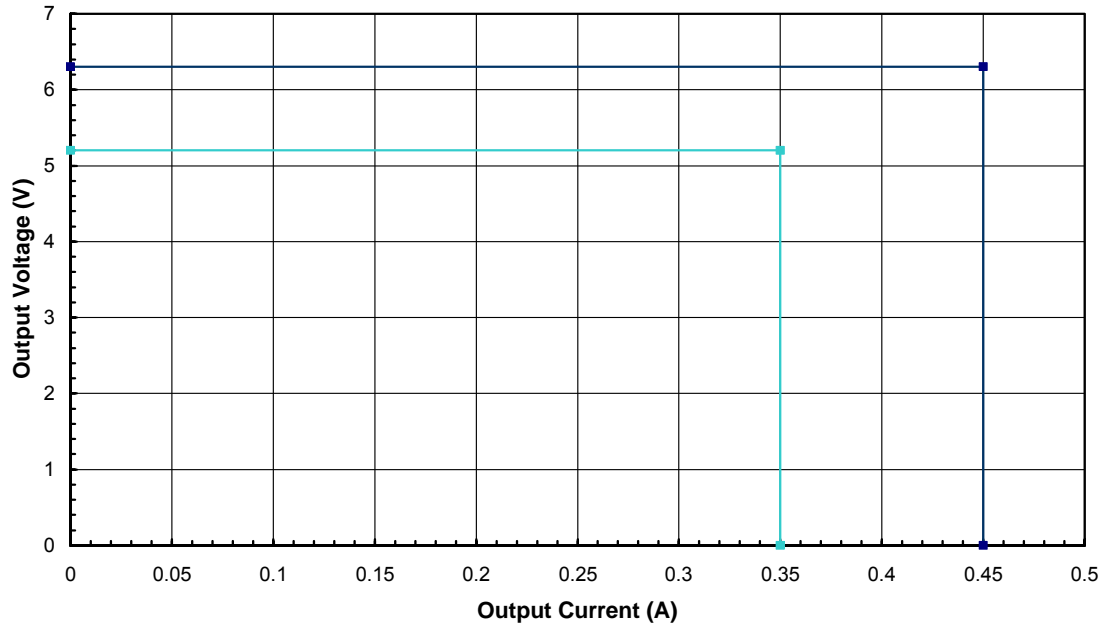

Figure 2 – Output CV/CC Envelope Specification.

3 Schematic

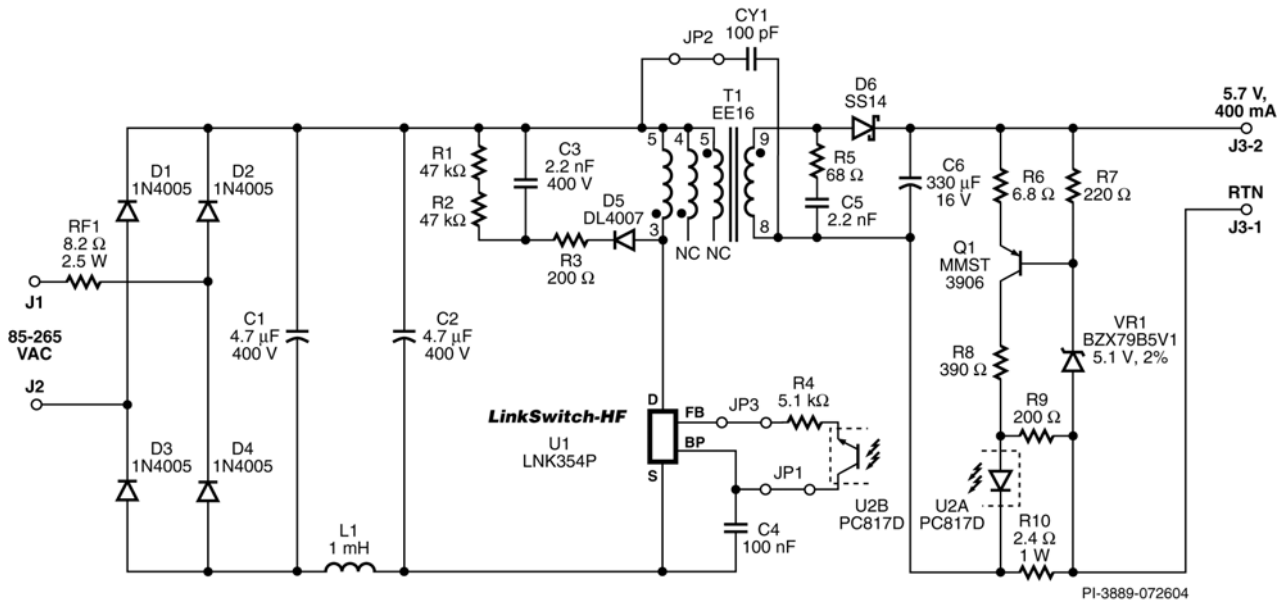

Figure 3 – EP73 Schematic.

4 Circuit Description

This circuit is configured as a flyback topology power supply utilizing the LNK354P. Secondary side constant voltage (CV) and constant current (CC) feedback circuitry provides characteristics required for battery charging applications.

4.1 Input EMI Filtering

The AC input voltage is rectified by input bridge D1 – D4. The rectified DC is then filtered by the bulk storage capacitors C1 and C2. Inductor L1, C1 and C2 form an input pi filter, which attenuates differential mode conducted EMI.

It is recommended that RF1 be of wire-wound construction to withstand input current surges while the input capacitor charges (metal film type are not recommended), and be compliant with safety flammability hazard requirements. Please consult your safety agency representative for requirements specific to your application.

4.2 LinkSwitch-HF Primary

The LNK354P device U1 integrates the power switching device, oscillator, control, startup, and protection functions. The integrated 700 V MOSFET has excellent switching characteristics allowing operation at the 200 kHz operating frequency.

The rectified and filtered input voltage is applied to the primary winding of T1. The other side of the transformer primary is driven by the integrated MOSFET in U1. Diode D5, C3, R1, R2, and R3 form the primary clamp network. This limits the peak drain voltage due to leakage inductance. Resistor R3 allows the use of a slow, low cost rectifier diode by limiting the reverse current through D5 when U1 turns on. The selection of a slow diode also improves conducted EMI.

To regulate the output, ON/OFF control is used. During normal operation, switching of the power MOSFET is disabled when a current greater than 49 μ A is delivered into the FEEDBACK pin. Current lower than this threshold allows a switching cycle to occur terminating when the peak primary current reaches the internal current limit.

Current into the FEEDBACK pin is fed, via optocoupler U2, from the BYPASS pin removing the need for an auxiliary bias winding on the transformer.

4.3 Output Rectification

Output rectification is provided by Schottky diode D6. The low forward voltage provides high efficiency across the operating range. Low ESR capacitor C6 achieves minimum output voltage ripple and noise in a small can size for the rated ripple current specification.

4.4 Output Feedback

Output voltage, in constant voltage (CV) mode, is set by the Zener diode VR1 plus emitter-base voltage of PNP transistor Q1. The V_{BE} of Q1 divided by the value of R7 sets

the bias current through VR1 (~2.7 mA). When the output voltage exceeds the threshold voltage determined by Q1 and VR1, Q1 is turned on and current flows through the LED of U2. As the LED current increases, the current fed into the FEEDBACK pin increases disabling further switching cycles of U1. At very light loads almost all switching cycles will be disabled, giving a low effective switching frequency and providing low no-load consumption.

Resistors R6 and R8 ensure that the ratings of Q1 are not exceeded during load transients.

Resistors R9 and R10 form the constant current (CC) sense circuit. Above approximately 400 mA, the voltage across the sense resistor exceeds the optocoupler diode forward conduction voltage of approximately 1 V. The current through the LED is therefore determined by the output current and CC control dominates the CV feedback loop.

4.5 Design Aspects for EMI

In addition to the simple input pi filter for differential mode EMI, this design makes use of shielding techniques in the transformer to reduce common mode EMI displacement currents. Resistor R5 and C5 are added to act as a damping network to reduce high frequency transformer ringing.

To return high frequency common mode displacement currents, a small value (100 pF) Y1 safety capacitor is placed across the isolation barrier. This is a small enough value to still meet the design requirement of low leakage current.

These techniques combined with the frequency jitter of *LinkSwitch-HF* give excellent conducted and radiated EMI performance.

5 PCB Layout

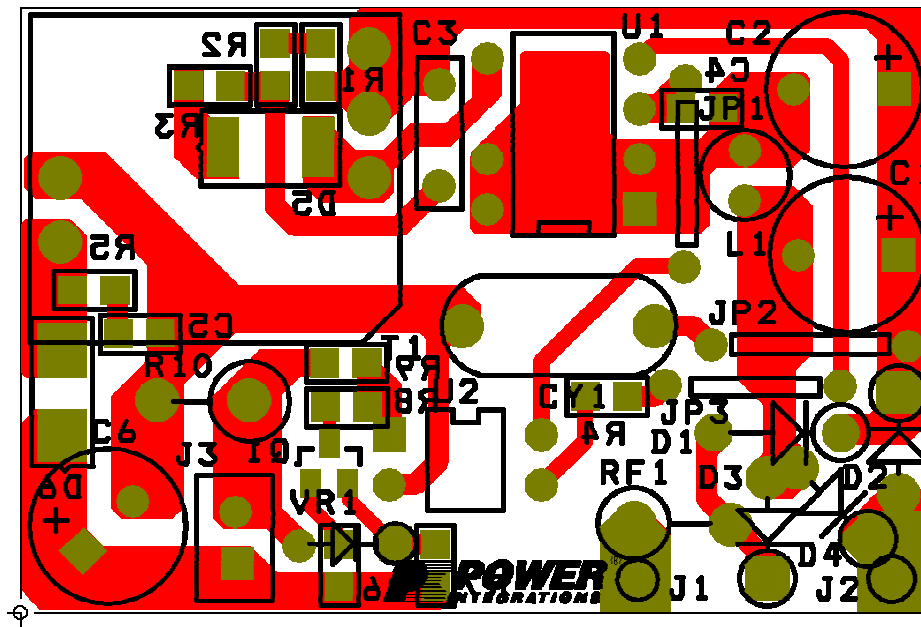

Figure 4 – Printed Circuit Layout (Approximately 1.2 x 1.8 inches).

6 Bill Of Materials

Item	Qty	Ref. Des.	Value	Description	Mfg Part Number	Manufacturer
1	2	C1, C2	4.7 μ F	4.7 μ F, 400 V, Electrolytic, (8 x 11.5) 4.7 μ F, 380 V, Electrolytic, (8 x 11.5)	SHD400WV 4.7uF XX380VB4R7M8X11LL	Sam Young United Chemi-Con
2	1	C3	2.2nF	2.2 nF, 400 V, Film	222237065222	Vishay (BC Components)
3	1	C4	100 nF	100 nF, 50 V, Ceramic, X7R, 0805	ECU-V1H221KBN	Panasonic
4	1	C5	2.2 nF	2.2 nF, 50 V, Ceramic, X7R, 0805	ECJ-2VB1H222K	Panasonic
5	1	C6	330 μ F	330 μ F, 16 V, Electrolytic, Very Low ESR, 72 m Ω , (8 x 11.5)	KZE16VB331MH11LL	Nippon Chemi-Con
6	1	CY1	100 pF	100 pF, Ceramic, Y1	440LT10	Vishay
7	4	D1, D2, D3, D4	1N4005	600 V, 1 A, Rectifier, DO-41	1N4005	Vishay
8	1	D5	DL4007	1000 V, 1 A, Rectifier, Glass Passivated, DO-213AA (MELF)	DL4007	Diodes Inc
9	1	D6	SS14	40 V, 1 A, Schottky, DO-214AC	SS14	Vishay
10	2	J1,J2	PCB Terminal 22 AWG	PCB Terminal Hole, 22 AWG	N/A	N/A
11	1	J3	Output Cable Assembly	6 ft, 0.25 Ω , 2.1 mm connector (custom)	3PH243	Anam Instruments (Korea)
12	3	JP1, JP2, JP3	J	Wire Jumper, Non insulated, 22 AWG, 0.4 in	298	Alpha
13	1	L1	1 mH	1 mH, 0.15 A, Ferrite Core	SBCP-47HY102B	Tokin
14	1	Q1	MMST3906	PNP, Small Signal BJT, 40 V, 0.2 A, SOT-323	MMST3906-7	Diodes Inc
15	2	R1, R2	47 k Ω	47 k Ω , 5%, 1/8 W, Metal Film, 0805	ERJ-6GEYJ473V	Panasonic
16	2	R3, R9	200 Ω	200 Ω , 5%, 1/8 W, Metal Film, 0805	ERJ-6GEYJ201V	Panasonic
17	1	R4	5.1 k Ω	5.1 k Ω , 5%, 1/8 W, Metal Film, 0805	ERJ-6GEYJ512V	Panasonic
18	1	R5	68 Ω	68 Ω , 5%, 1/8 W, Metal Film, 0805	ERJ-6GEYJ680V	Panasonic
19	1	R6	6.8 Ω	6.8 Ω , 5%, 1/8 W, Metal Film, 0805	ERJ-6GEYJ6R8V	Panasonic
20	1	R7	220 Ω	220 Ω , 5%, 1/8 W, Metal Film, 0805	ERJ-6GEYJ221V	Panasonic
21	1	R8	390 Ω	390 Ω , 5%, 1/8 W, Metal Film, 0805	ERJ-6GEYJ391V	Panasonic
22	1	R10	2.4 Ω	2.4 Ω , 5%, 1 W, Metal Oxide	RSF100JB-2R4	Yageo
23	1	RF1	8.2 Ω	8.2 Ω , 2.5 W, Fusible/Flame-Proof Wire-Wound	CRF253-4 5T 8R2	Vitrohm
24	1	T1	EE16	Custom	SiI6032 LSLA40331B IM 040 416 11	Hical Li Shin Vogt
25	1	U1	LNK354P	LinkSwitch-HF, LNK354P, DIP-8B	LNK354P	Power Integrations
26	1	U2	PC817D	Optocoupler, 80 V, CTR 300-600%, 4-DIP	PC817X4, IPC817D	Sharp, ISP
27	1	VR1	BZX79-B5V1	5.1 V, 500 mW, 2%, DO-35	BZX79-B5V1	Vishay

7 Transformer Specification

7.1 Electrical Diagram

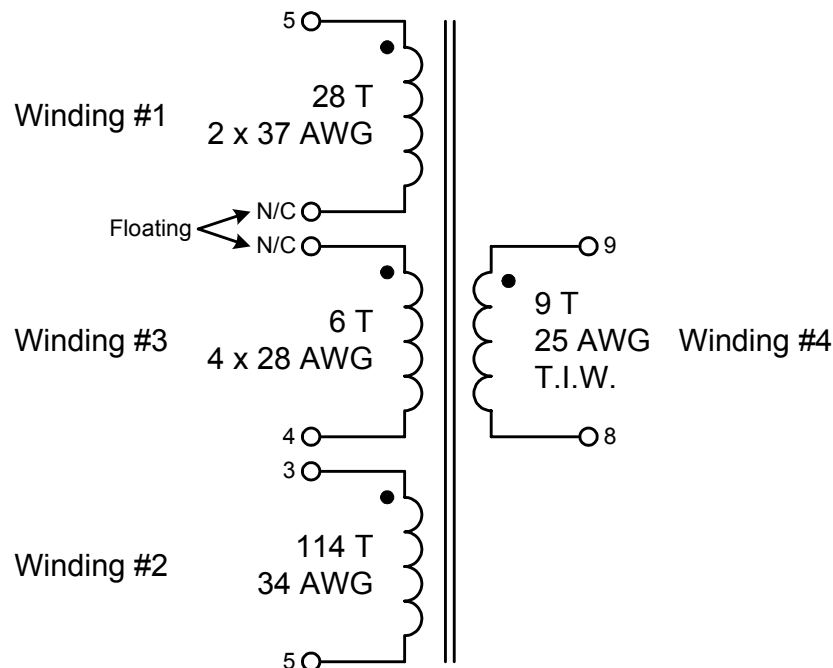

Figure 5 – Transformer Electrical Diagram.

7.2 Electrical Specifications

Electrical Strength	60 Hz 1 minute, from Pins 3-5 to Pins 6-10	3000 VAC
Primary Inductance	Pins 3-5, all other windings open, measured at 200 kHz, 0.4 VRMS	916 μ H, -/+12%
Resonant Frequency	Pins 3-5, all other windings open	900 kHz (Min.)
Primary Leakage Inductance	Pins 3-5, with Pins 8-9 shorted, measured at 200 kHz, 0.4 VRMS	75 μ H (Max.)

7.3 Materials

Item	Description
[1]	Core: PC40EE16-Z, TDK or equivalent Gapped for A_L of 70 nH/T ²
[2]	Bobbin: EE16 Horizontal 10 pin
[3]	Magnet Wire: #37 AWG
[4]	Magnet Wire: #34 AWG
[5]	Magnet Wire: #28 AWG
[6]	Triple Insulated Wire: #25 AWG.
[7]	Tape: 3M 1298 Polyester Film, 2.0 mils thick, 8.4 mm wide
[8]	Varnish

7.4 Transformer Build Diagram

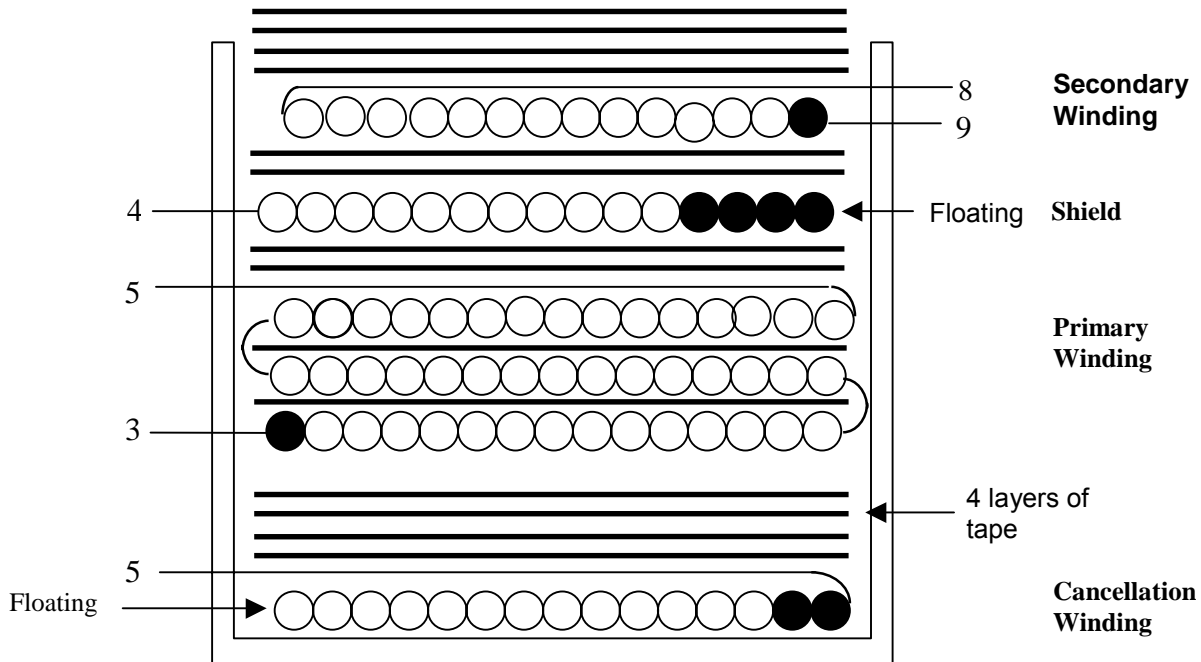

Figure 6 – Transformer Build Diagram.

7.5 Transformer Construction

First Winding - Cancellation	Primary pin side of the bobbin oriented to left-hand side. Start at Pin 8 temporarily. Wind 28 bifilar turns of item [3] from right to left. Wind with tight tension across entire bobbin evenly and leave the finish end free. Bend the free end 90° and draw the wire across the bobbin window cutting in the center of the bobbin. Move start end of winding from Pin 8 to Pin 5.
Insulation	4 Layers of tape [6] for insulation.
Second Winding - Primary	Start at Pin 3 wind 38 turns of item [4] from left to right. Add one layer of tape. Wind another 38 turns from right to left. Add one layer of tape. Wind 38 turns in third layer from left to right. Wind with tight tension across entire bobbin evenly. Finish at Pin 5.
Insulation	2 Layers of tape [6] for insulation.
Third Winding - Shield	Start at Pin 8 temporarily, wind 6 quadfilar turns of item [5]. Wind from right to left with tight tension in a single uniform layer across entire width of bobbin. Finish on Pin 4. Cut start end at Pin 8 ensuring uniformity of winding and tape down in place.
Insulation	2 Layers of tape [7] for insulation.
Fourth Winding	Start at Pin 9, wind 9 turns of item [6] from right to left. Wind uniformly, in a single layer across entire bobbin width. Finish on Pin 8.
Outer insulation	3 Layers of tape [7] for insulation.
Core Assembly	Assemble and secure core halves.
Varnish	Dip Varnish [8] – DO NOT VACUUM IMPREGNATE

8 Transformer Design Spreadsheet

ACDC_LinkSwitch-HF_060904; Rev1-1; Copyright Power Integrations Inc. 2004	INPUT	INFO	OUTPUT	UNIT	ACDC_LinkSwitch-HF_060904_Rev1-1.xls; LinkSwitch-TN_HF Continuous/Discontinuous Flyback Transformer Design Spreadsheet
ENTER APPLICATION VARIABLES					
VACMIN	85			Volts	Minimum AC Input Voltage
VACMAX	265			Volts	Maximum AC Input Voltage
fL	50			Hertz	AC Mains Frequency
VO	5.7			Volts	Output Voltage
IO	0.4			Amps	Power Supply Output Current
CC Threshold Voltage	1.04			Volts	Voltage drop across sense resistor. For CV only circuits enter "0"
PO			2.696	Watts	Output Power
n	0.57				Efficiency Estimate. For CV only designs enter 0.7 if no better data available
Z			0.75		Loss Allocation Factor
tC	3			mSeconds	Bridge Rectifier Conduction Time Estimate
CIN	9.4			uFarads	Input Capacitance
ENTER LinkSwitch-HF VARIABLES					
LinkSwitch-HF	LNK354			Universal	115 Doubled/230V
Chosen Device		LNK354	Power Out	4.5 W	5 W
ILIMITMIN			0.233	Amps	Minimum Current Limit
ILIMITMAX			0.268	Amps	Maximum Current Limit
fS			186000	Hertz	Minimum Device Switching Frequency
fS Full Load	178750		178750	Hertz	Maximum switching frequency at full load and LP min. For maximum power capability enter 186 kHz (fs_min), reducing this value will reduce EMI but lower power capability
VOR	91		91	Volts	Reflected Output Voltage
VDS			10	Volts	LinkSwitch-HF on-state Drain to Source Voltage
VD	0.45		0.45	Volts	Output Winding Diode Forward Voltage Drop
KP			1.15		Ripple to Peak Current Ratio (0.6<KRP<1.0 : 1.0<KDP<6.0)
ENTER TRANSFORMER CORE/CONSTRUCTION VARIABLES					
Core Type	EE16		EE16		User-Selected transformer core
Core		EE16		P/N:	PC40EE16-Z
Bobbin		EE16_BOBBIN		P/N:	EE16_BOBBIN
AE			0.192	cm^2	Core Effective Cross Sectional Area
LE			3.5	cm	Core Effective Path Length
AL			1140	nH/T^2	Ungapped Core Effective Inductance
BW			8.6	mm	Bobbin Physical Winding Width
M			0	mm	Safety Margin Width (Half the Primary to Secondary Creepage Distance)
L			3		Number of Primary Layers
NS	9		9		Number of Secondary Turns
DC INPUT VOLTAGE PARAMETERS					
VMIN			90	Volts	Minimum DC Input Voltage
VMAX			375	Volts	Maximum DC Input Voltage
CURRENT WAVEFORM SHAPE PARAMETERS					
DMAX			0.54		Maximum Duty Cycle
I AVG			0.05	Amps	Average Primary Current
IP			0.23	Amps	Minimum Peak Primary Current
IR			0.23	Amps	Primary Ripple Current
IRMS			0.09	Amps	Primary RMS Current

TRANSFORMER PRIMARY DESIGN PARAMETERS					
LP			916	uHenries	Typical Primary Inductance. +/- 12%
LP_TOLERANCE			12	%	Primary inductance tolerance
NP			114		Primary Winding Number of Turns
ALG			71	nH/T^2	Gapped Core Effective Inductance
BM		Caution	1298	Gauss	!!! Caution. Flux densities above ~ 1250 Gauss may produce audible noise. Verify with dip varnished sample transformers. Increase NS to greater than or equal to 10 turns or increase VOR
BAC			649	Gauss	AC Flux Density for Core Loss Curves (0.5 X Peak to Peak)
ur			1654		Relative Permeability of Ungapped Core
LG			0.32	mm	Gap Length (Lg > 0.1 mm)
BWE			25.8	mm	Effective Bobbin Width
OD			0.23	mm	Maximum Primary Wire Diameter including insulation
INS			0.05	mm	Estimated Total Insulation Thickness (= 2 * film thickness)
DIA			0.18	mm	Bare conductor diameter
AWG			34	AWG	Primary Wire Gauge (Rounded to next smaller standard AWG value)
CM			40	Cmils	Bare conductor effective area in circular mils
CMA			466	Cmils/Amp	Primary Winding Current Capacity (200 < CMA < 500)
TRANSFORMER SECONDARY DESIGN PARAMETERS					
Lumped parameters					
ISP			2.95	Amps	Peak Secondary Current
ISRMS			1.02	Amps	Secondary RMS Current
IRIPPLE			0.94	Amps	Output Capacitor RMS Ripple Current
CMS			205	Cmils	Secondary Bare Conductor minimum circular mils
AWGS			26	AWG	Secondary Wire Gauge (Rounded up to next larger standard AWG value)
DIAS			0.41	mm	Secondary Minimum Bare Conductor Diameter
ODS			0.96	mm	Secondary Maximum Outside Diameter for Triple Insulated Wire
INSS			0.27	mm	Maximum Secondary Insulation Wall Thickness
VOLTAGE STRESS PARAMETERS					
VDRAIN			586	Volts	Maximum Drain Voltage Estimate (Includes Effect of Leakage Inductance)
PIVS			35	Volts	Output Rectifier Maximum Peak Inverse Voltage
TRANSFORMER SECONDARY DESIGN PARAMETERS (MULTIPLE OUTPUTS)					
1st output					
VO1			5.7	Volts	Output Voltage (if unused, defaults to single output design)
IO1			0.473	Amps	Output DC Current
PO1			2.70	Watts	Output Power
VD1			0.45	Volts	Output Diode Forward Voltage Drop
NS1			8.34		Output Winding Number of Turns
ISRMS1			1.210	Amps	Output Winding RMS Current
IRIPPLE1			1.11	Amps	Output Capacitor RMS Ripple Current
PIVS1			33	Volts	Output Rectifier Maximum Peak Inverse Voltage
CMS1			242	Cmils	Output Winding Bare Conductor minimum circular mils
AWGS1			26	AWG	Wire Gauge (Rounded up to next larger standard AWG value)
DIAS1			0.41	mm	Minimum Bare Conductor Diameter
ODS1			1.03	mm	Maximum Outside Diameter for Triple Insulated Wire
2nd output					
VO2				Volts	Output Voltage
IO2				Amps	Output DC Current
PO2			0.00	Watts	Output Power
VD2				Volts	Output Diode Forward Voltage Drop
NS2			0.00		Output Winding Number of Turns
ISRMS2			0.000	Amps	Output Winding RMS Current
IRIPPLE2			0.00	Amps	Output Capacitor RMS Ripple Current
PIVS2			0	Volts	Output Rectifier Maximum Peak Inverse Voltage
CMS2			0	Cmils	Output Winding Bare Conductor minimum circular mils
AWGS2			N/A	AWG	Wire Gauge (Rounded up to next larger standard AWG value)
DIAS2			N/A	mm	Minimum Bare Conductor Diameter
ODS2			N/A	mm	Maximum Outside Diameter for Triple Insulated Wire

3rd output					
VO3				Volts	Output Voltage
IO3				Amps	Output DC Current
PO3			0.00	Watts	Output Power
VD3				Volts	Output Diode Forward Voltage Drop
NS3			0.00		Output Winding Number of Turns
ISRMS3			0.000	Amps	Output Winding RMS Current
IRIPPLE3			0.00	Amps	Output Capacitor RMS Ripple Current
PIVS3			0	Volts	Output Rectifier Maximum Peak Inverse Voltage
CMS3			0	Cmils	Output Winding Bare Conductor minimum circular mils
AWGS3			N/A	AWG	Wire Gauge (Rounded up to next larger standard AWG value)
DIAS3			N/A	mm	Minimum Bare Conductor Diameter
ODS3			N/A	mm	Maximum Outside Diameter for Triple Insulated Wire
Total power			2.696	Watts	Total Output Power

9 Performance Data

All measurements performed at room temperature, 60 Hz input frequency. A DC output cable was not included.

9.1 Efficiency

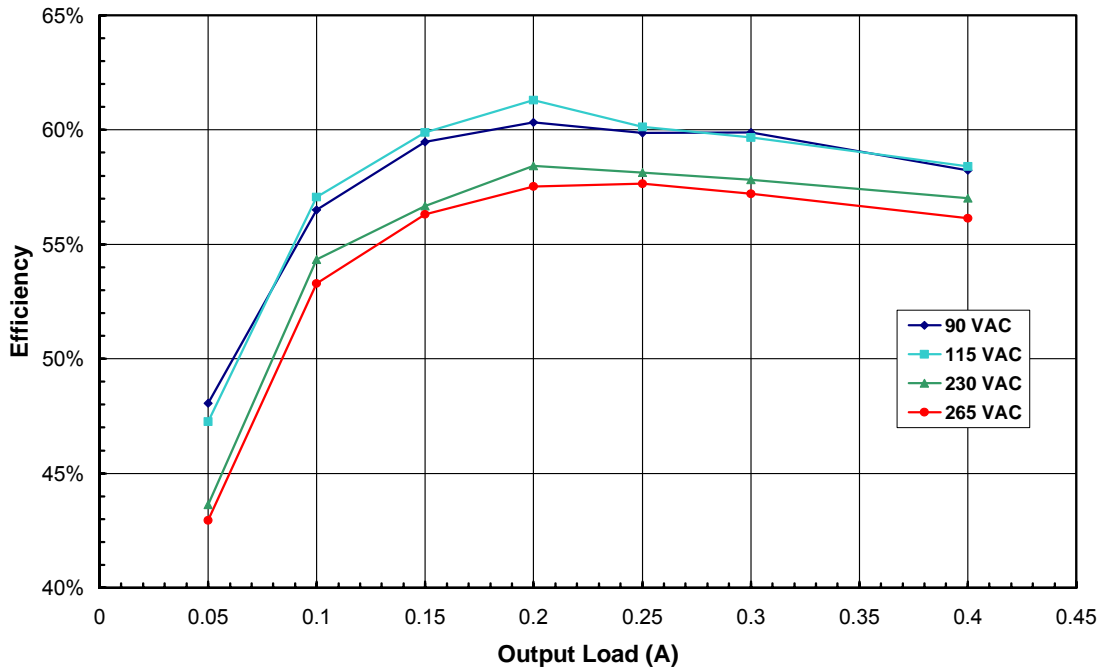

Figure 7 – Efficiency vs. Output Current (CV), Room Temperature, 60 Hz.

9.2 No-load Input Power

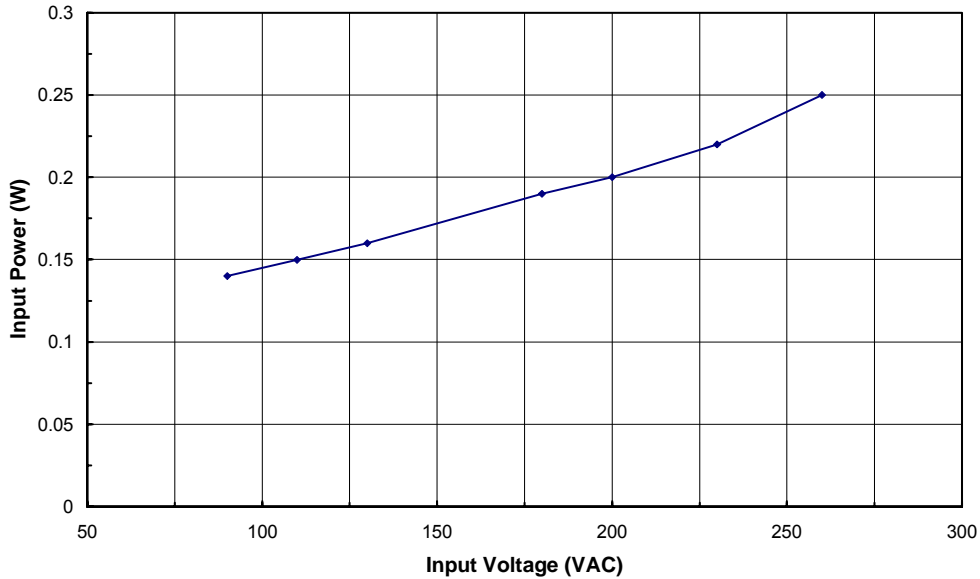

Figure 8 – Zero Load Input Power vs. Input Line Voltage, Room Temperature, 60 Hz.

9.3 Regulation

9.3.1 CV and CC Output Characteristics

No measurable difference was seen over line voltage variation.

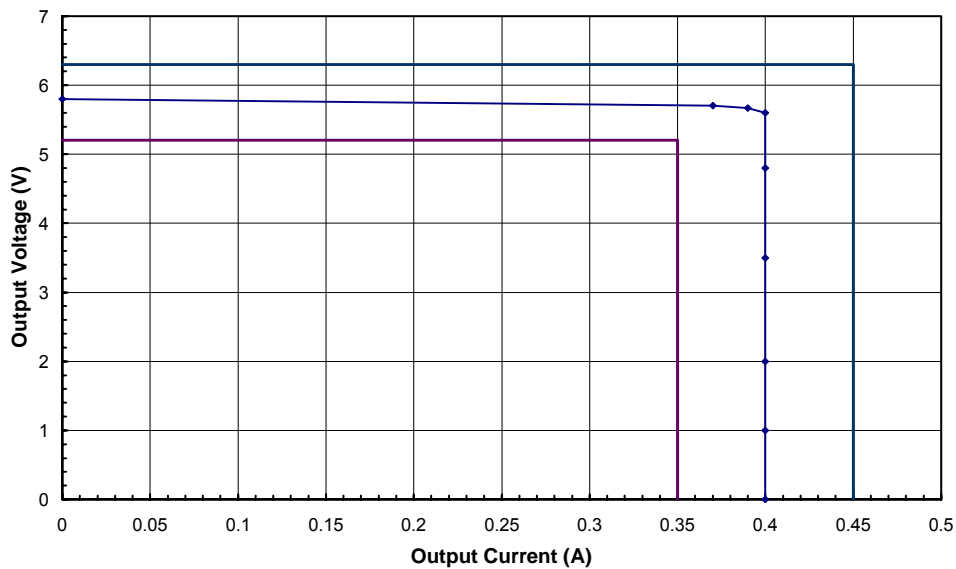

Figure 9 – CV/CC Output Characteristic with Specification Limits Added, Room Temperature.

9.3.2 Load Regulation in CV

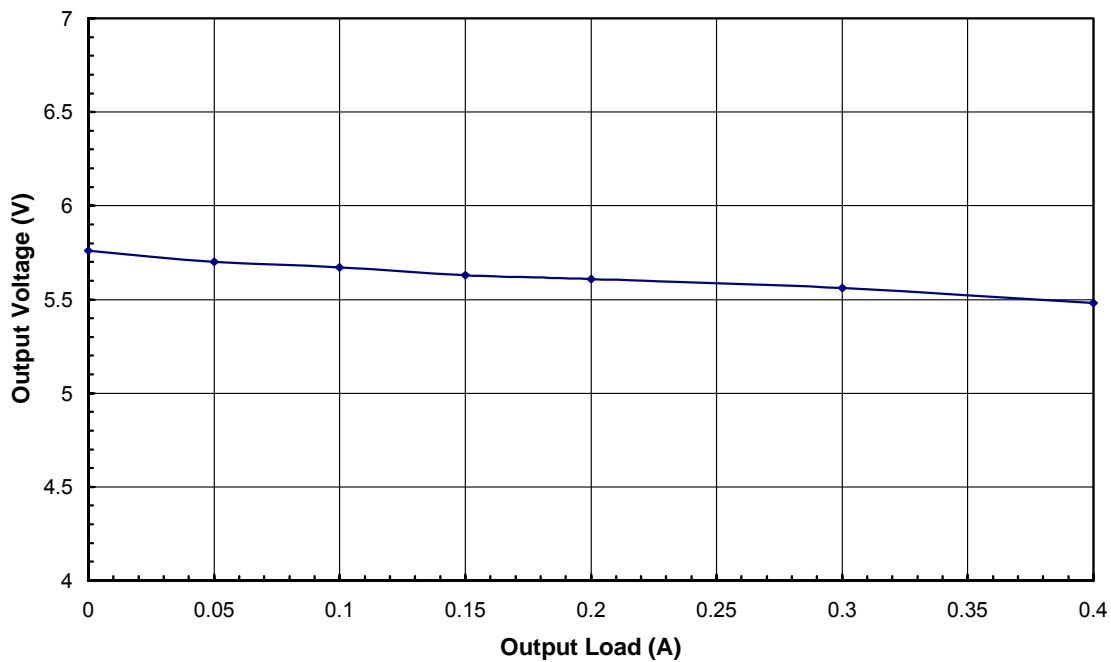

Figure 10 – Load Regulation in CV Operation, Room Temperature, Full Load.

10 Thermal Performance

Temperature of key components was recorded using a T-type thermocouple. Thermocouples were soldered directly to LNK354P SOURCE pin and cathode of output rectifier. Thermocouples were glued to the output capacitor and transformer external core/winding surfaces.

The unit was operated at full load in free convection in a thermal chamber inside an additional enclosure to eliminate airflow. The ambient was measured in the additional enclosure and maintained at 40 °C.

Temperature (°C)		
Item	85 VAC	265 VAC
Ambient	40	40
LNK354P (U1)	94	96
Transformer (T1)	80	82
Output Rectifier (D6)	67	64
Output Capacitor (C6)	60	58

For reference an infrared thermograph was taken with the unit operating at room ambient showing the relative temperature rise of the key supply components.

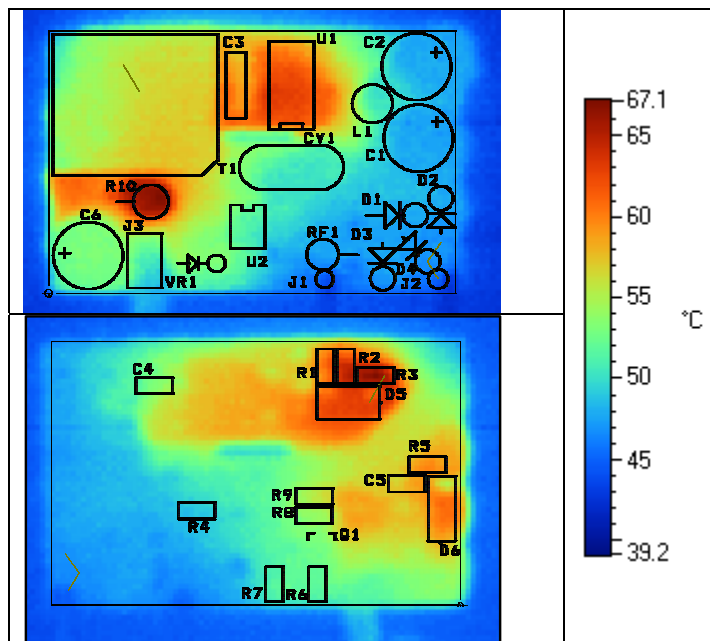

Figure 11 – Infrared Thermograph of PCB (85 VAC, Room Ambient).

11 Line Surge

Surge Voltage	Phase Angle	Generator Impedance	Number of Strikes	Test Result
2 kV	90°	2 Ω	10	PASS
2 kV	90°	12 Ω	10	PASS

12 Waveforms

12.1 Drain Voltage and Current, Normal Operation

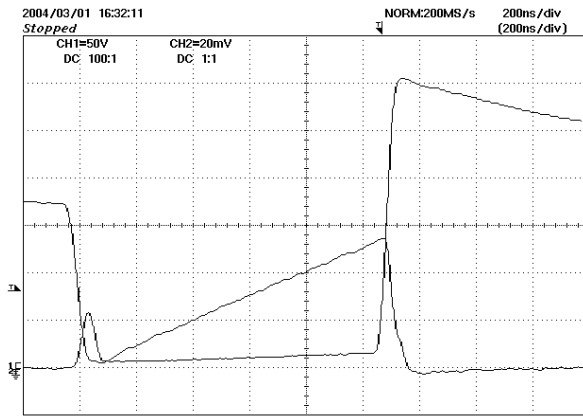

Figure 12 – 115 VAC, Full Load.
Upper: I_{DRAIN} , 0.1 A / div.
Lower: V_{DRAIN} , 50 V, 200 ns / div.

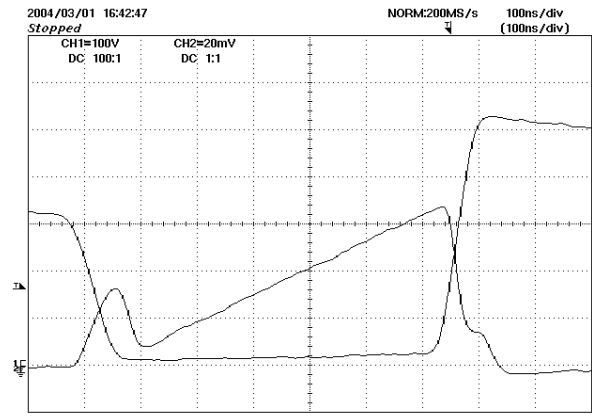

Figure 13 – 230 VAC, Full Load.
Upper: I_{DRAIN} , 0.1 A / div.
Lower: V_{DRAIN} , 100 V, 100 ns / div.

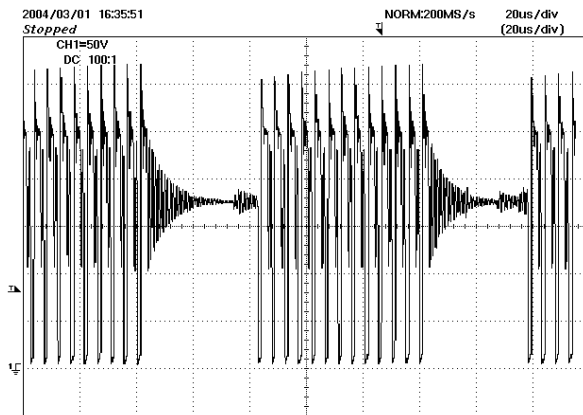

Figure 14 – 115 VAC, Full Load.
 V_{DRAIN} , 50 V, 20 μ s / div.

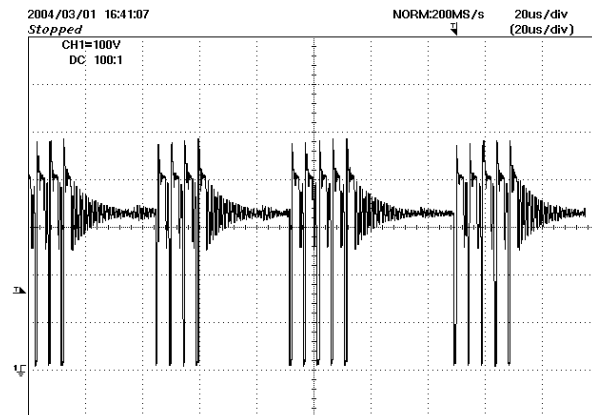

Figure 15 – 115 VAC, Full Load.
 V_{DRAIN} , 100 V, 20 μ s / div.

12.2 Output Voltage Start-up Profile

Startup into resistive full load and no-load was verified. Load resistor was sized at 13 Ω to maintain 300 mA under steady-state conditions.

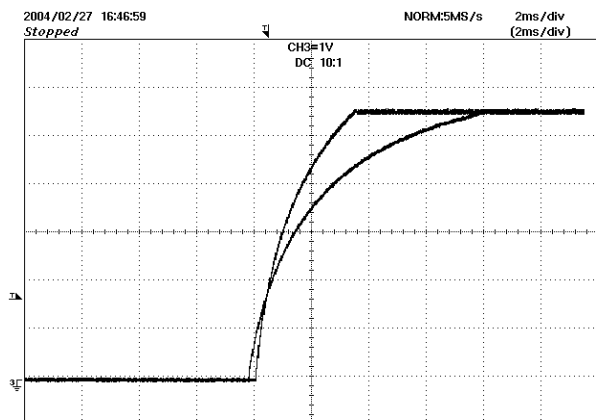

Figure 16 – Start-up Profile 115 VAC.
Fast trace is no load rise time.
Slower trace is maximum load (13 Ω)
1 V, 2 ms / div.

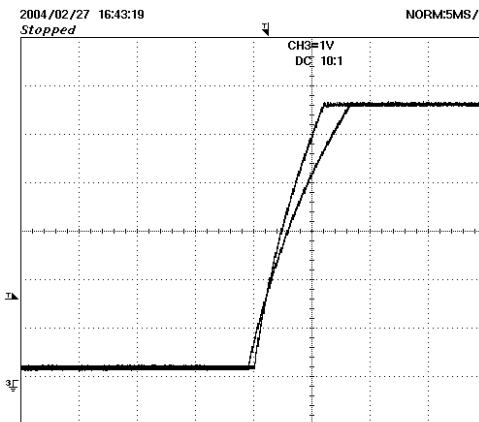

Figure 17 – Start-up Profile 230 VAC.
Fast trace is no load rise time.
Slower trace is maximum load (13 Ω)
1 V, 2 ms / div.

12.3 Drain Voltage and Current Start-up Profile

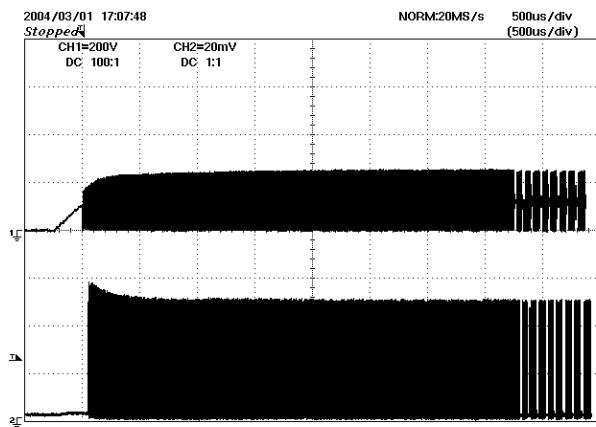

Figure 18 – 90 VAC Input and Maximum Load (Resistive Load).
Upper: 200 V & 500 μ s / div.
Lower: V_{DRAIN} , I_{DRAIN} , 0.1 A / div.

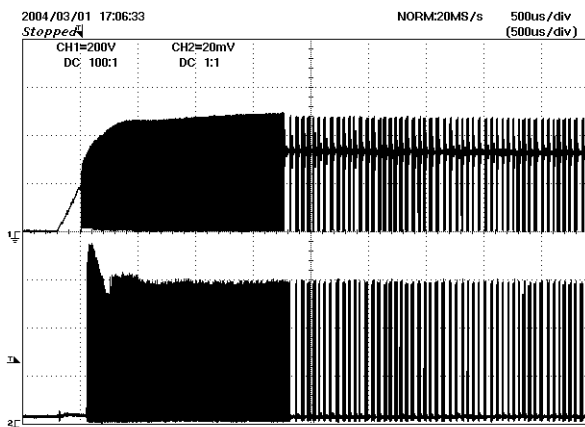

Figure 19 – 265 VAC Input and Maximum Load (Resistive Load).
Upper: 200 V & 500 μ s / div.
Lower: V_{DRAIN} , I_{DRAIN} , 0.1 A / div.

12.4 Load Transient Response (75% to 100% Load Step)

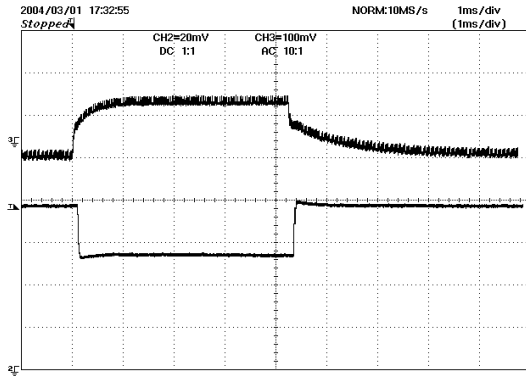

Figure 20 – Transient Response, 115 VAC, 75-100-75% Load Step.
Upper: V_{OUT} 20 mV, 1 ms / div.
Lower: I_{OUT} , 0.1 A / div.

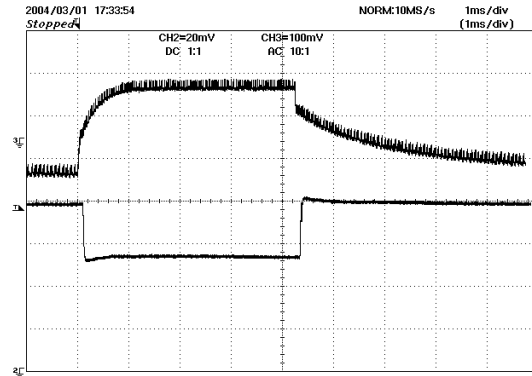

Figure 21 – Transient Response, 230 VAC, 75-100-75% Load Step.
Upper: V_{OUT} , 20 mV, 1ms / div.
Lower: I_{OUT} , 0.1 A / div.

12.5 Output Ripple Measurements

12.5.1 Ripple Measurement Technique

For DC output ripple measurements, a modified oscilloscope test probe must be utilized in order to reduce spurious signals due to pickup. Attach probe with end cap and ground clip removed to circuit shown below which is attached to end of output cable.

The 5125BA probe adapter is affixed

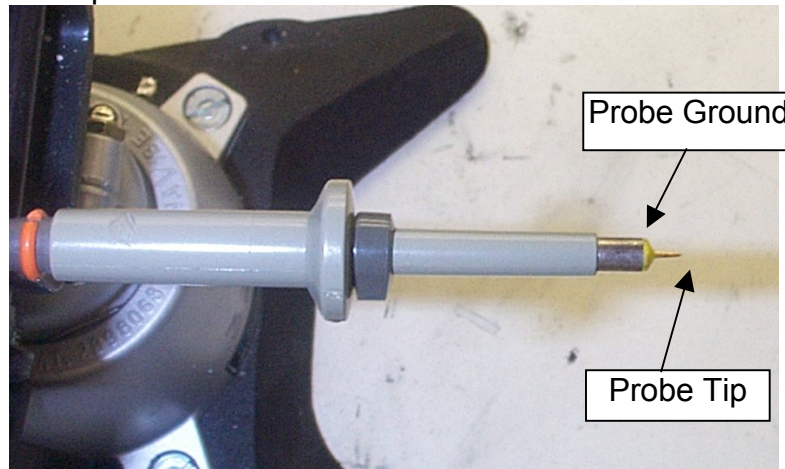

Figure 22 – Oscilloscope Probe Prepared for Ripple Measurement (End Cap and Ground Lead Removed).

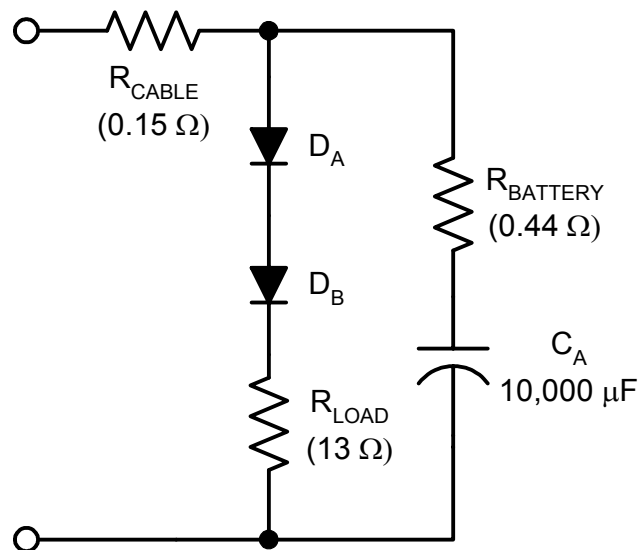

Figure 23 – Equivalent Battery Model Circuit.

12.5.2 Measurement Results

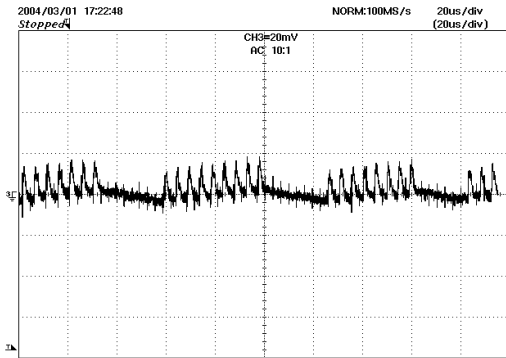

Figure 24 – Output Ripple, 115 VAC, Full Load.
20 μ s, 50 mV / div.

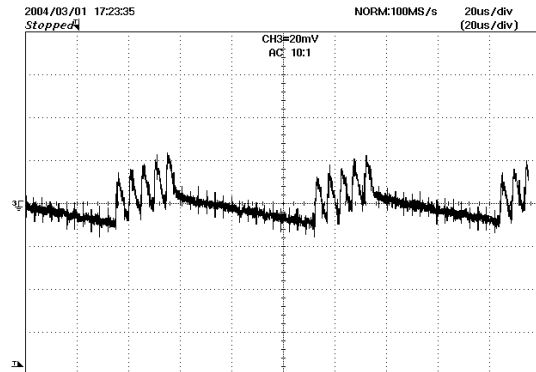

Figure 25 – Output Ripple, 230 VAC, Full Load.
20 μ s, 50 mV / div.

13 Conducted EMI

Conducted emissions tests were completed at 115 VAC and 230 VAC at full load, 5.5 V / 400 mA. Measurements were completed with Artificial Hand connection and floating DC output load resistor. An output DC cable was included.

Composite EN55022B / CISPR22B conducted limits are shown.

13.1 115 VAC Input, Full Load

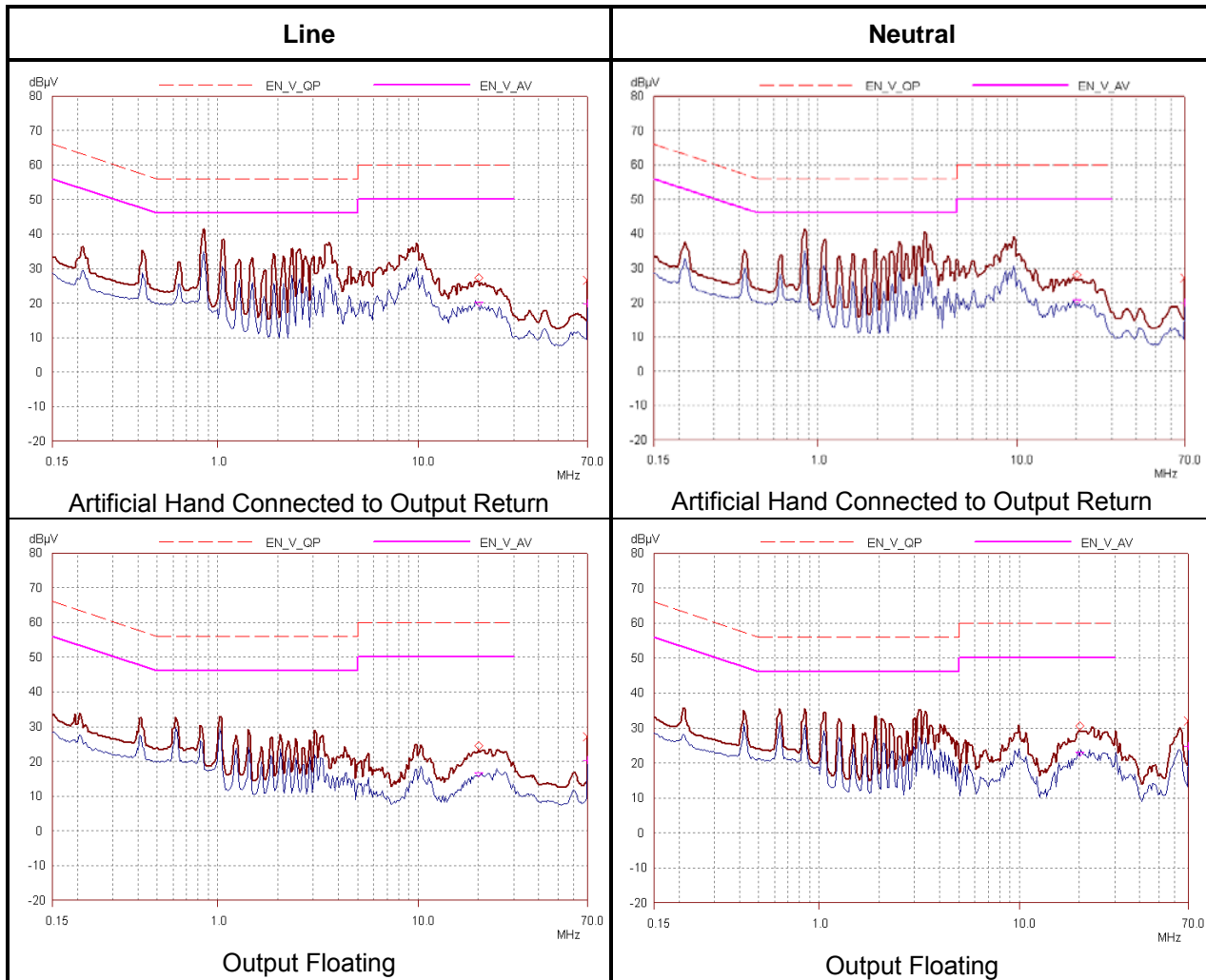

13.2 230 VAC Input, Full Load

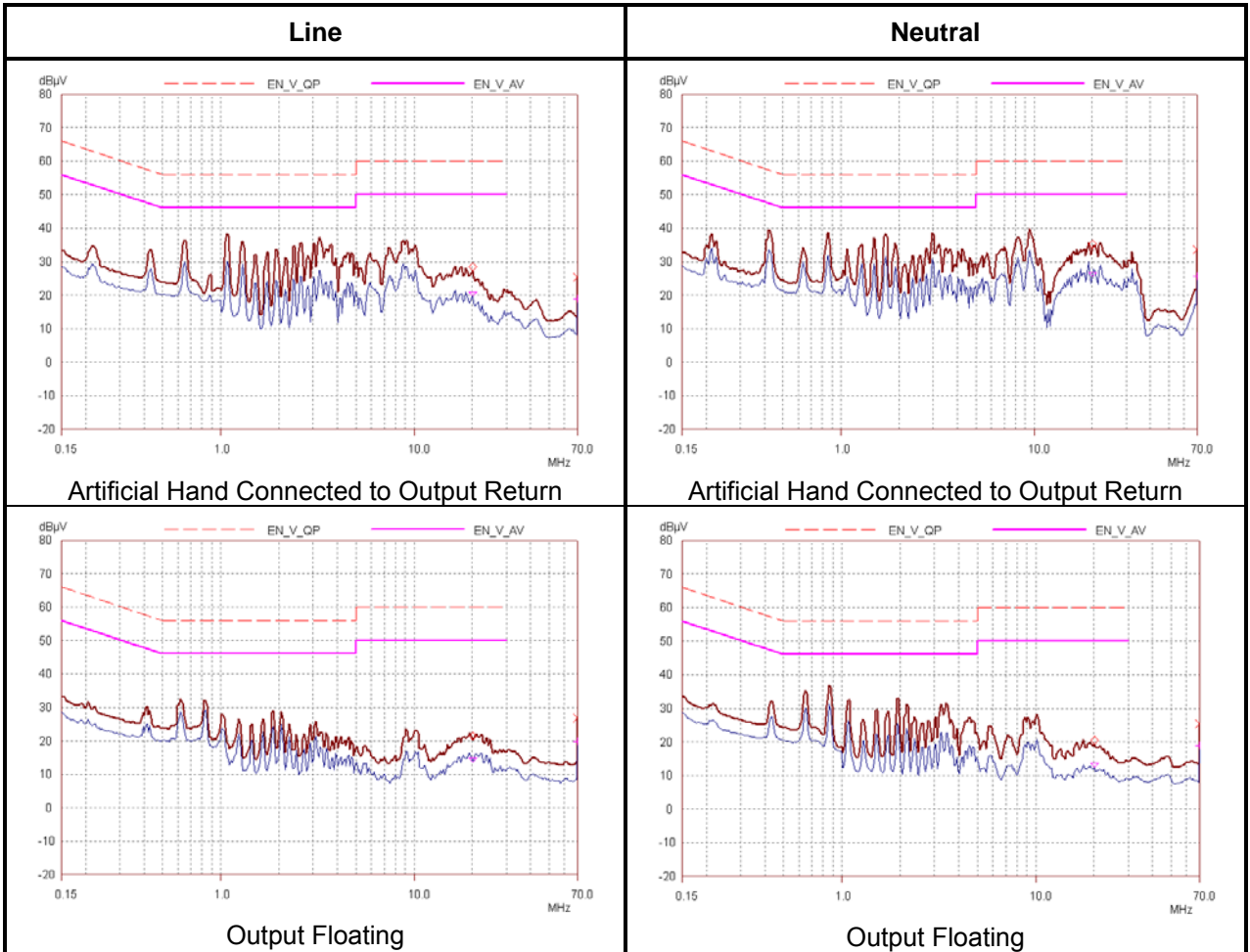

14 Appendix A – Design Modification Required To Remove Y Capacitor

In some applications where extremely low leakage current is required, it may be necessary to remove the Y capacitor (CY1) that bridges the primary-to-secondary isolation barrier.

In order to achieve this while still meeting conducted and radiated EMI requires re-optimization of the transformer. As with all no Y capacitor transformer designs, the mechanical arrangement and relative spacing of the windings has a large impact on the EMI performance of the supply. Therefore ensure that transformers are wound consistently to ensure repeatable EMI performance.

14.1 No Y capacitor Transformer Specification

14.1.1 Electrical Diagram

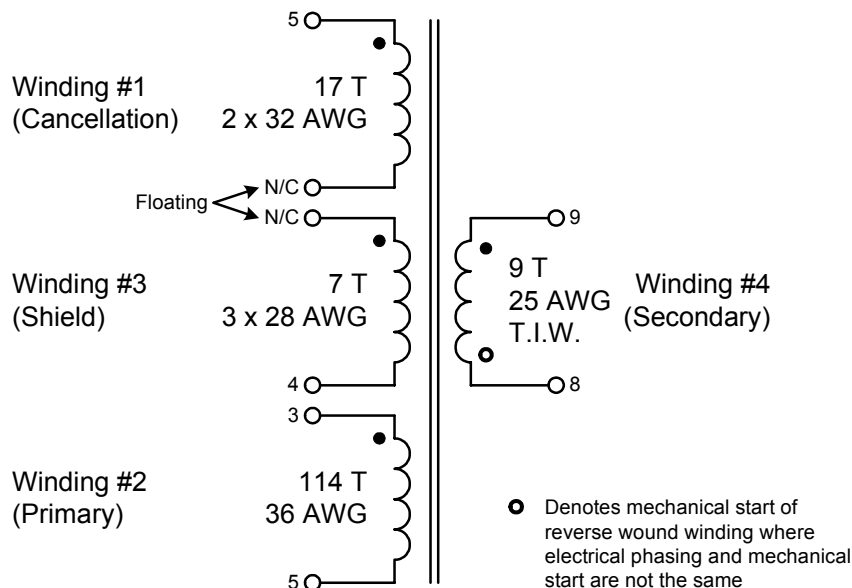

14.1.2 Electrical Specifications

Electrical Strength	60Hz 1minute, from Pins 3-5 to Pins 6-10	3000 VAC
Primary Inductance	Pins 3-5, all other windings open, measured at 200 kHz, 0.4 VRMS	916 μ H, -/+12%
Resonant Frequency	Pins 3-5, all other windings open	900 kHz (Min.)
Primary Leakage Inductance	Pins 3-5, with Pins 8-9 shorted, measured at 200 kHz, 0.4 VRMS	75 μ H (Max.)

14.1.3 Winding Instructions

WD1 Cancellation Winding	Primary pin side of the bobbin oriented to left-hand side. Add 1 layer of item [7] to the secondary side. Start at Pin 5. Wind 17 bifilar turns of item [3] from right to left. Wind with tight tension across entire bobbin evenly. Cut the ends of the bifilar and leave floating.
Insulation	4 Layers of tape [8] for insulation.
WD#2 Primary winding	Apply 1 layer of item [7] to the secondary side. Start at Pin 3. Wind 40 turns of item [4] from left to right. Add 1 layer of item [8] and 1 layer of item [7] to the secondary side. Wind another 40 turns from right to left. Add 1 layer of item [8] and 1 layer of item [7] to the secondary side. Wind 34 turns in third layer from left to right. Wind with tight tension across entire bobbin evenly. Finish at Pin 5.
Insulation	2 Layers of tape [8] for insulation.
WD #3 Shield Winding	Start at Pin 8 temporarily, wind 7 trifilar turns of item [5]. Wind from right to left with tight tension. Wind uniformly, in a single layer across entire width of bobbin. Finish on Pin 4. Cut the lead of the starting end and ensure that the void area around the starting end is entirely covered with the cut end. Tape down in place.
Insulation	2 Layers of tape [8] for insulation.
WD #4 Secondary Winding	Reverse orientation of bobbin such that secondary pin side is to the left-hand side. Start at Pin 8, wind 9 turns of item [6] from right to left. Wind uniformly, in a single layer across entire bobbin evenly. Finish on Pin 9.
Outer Insulation	3 Layers of tape [8] for insulation.
Core Assembly	Assemble and secure core halves using item [9].
Core Grounding	Solder 1 end of item [10] to Pin 5. Wrap 2 turns around entire transformer making sure that wire is in contact with cores. Terminate end to Pin 5.
Varnish	Dip Varnish, item [11]

14.1.4 Materials

Item	Description
[1]	Core: PC40EE16-Z, TDK or equivalent Gapped for A_L of 192 nH/T ²
[2]	Bobbin: EE16 Horizontal 10 pin
[3]	Magnet Wire: #32 AWG
[4]	Magnet Wire: #36 AWG
[5]	Magnet Wire: #28 AWG
[6]	Triple Insulated Wire: #25 AWG.
[7]	Tape: 3M # 44 Polyester web. 1.5 mm wide
[8]	Tape: 3M 1298 Polyester Film, 2.0 mils thick, 8.0 mm wide
[9]	Tape: 3M 1298 Polyester Film, 2.0 mils thick, 3.0 mm wide
[10]	Solid Wire: #28 AWG
[11]	Varnish

14.1.5 Transformer Build Diagram

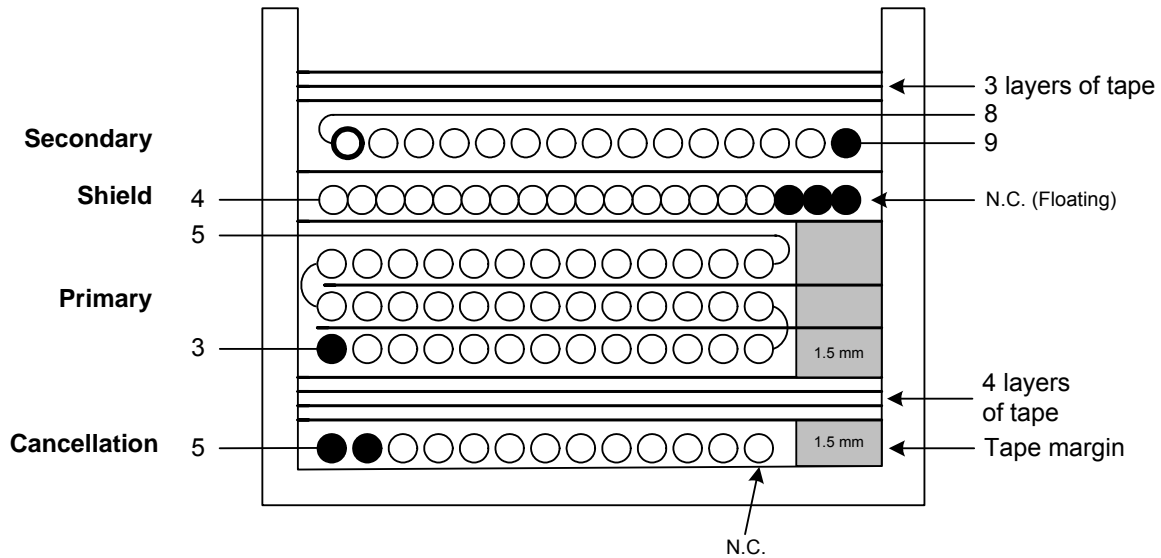

- Denotes mechanical start of winding where mechanical start and electrical phase are different
- Denotes mechanical start and electrical phase of winding where they are the same

14.2 EMI Results

Both conducted and radiated EMI results with the revised transformer and CY1 removed showed excellent margin to respective standards. Tests were performed on both line and neutral (conducted) with the output return connected to the artificial hand input of the LISN (line impedance stabilization network). The red trace represents EMI measured with a quasi peak detector and the blue an average detector. These results should be below the respective limit line of the same color.

Radiated results gave a margin of > 6dB.

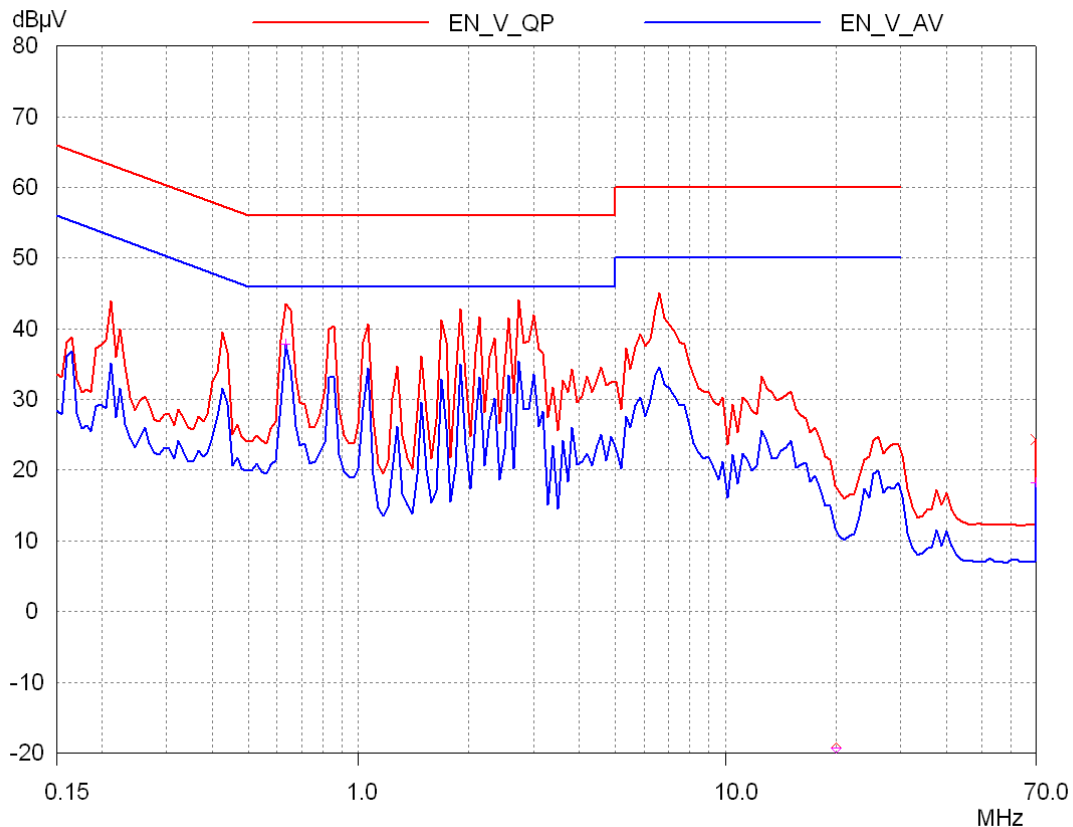

Figure 26 – No Y Capacitor Conducted EMI Results (115 VAC).

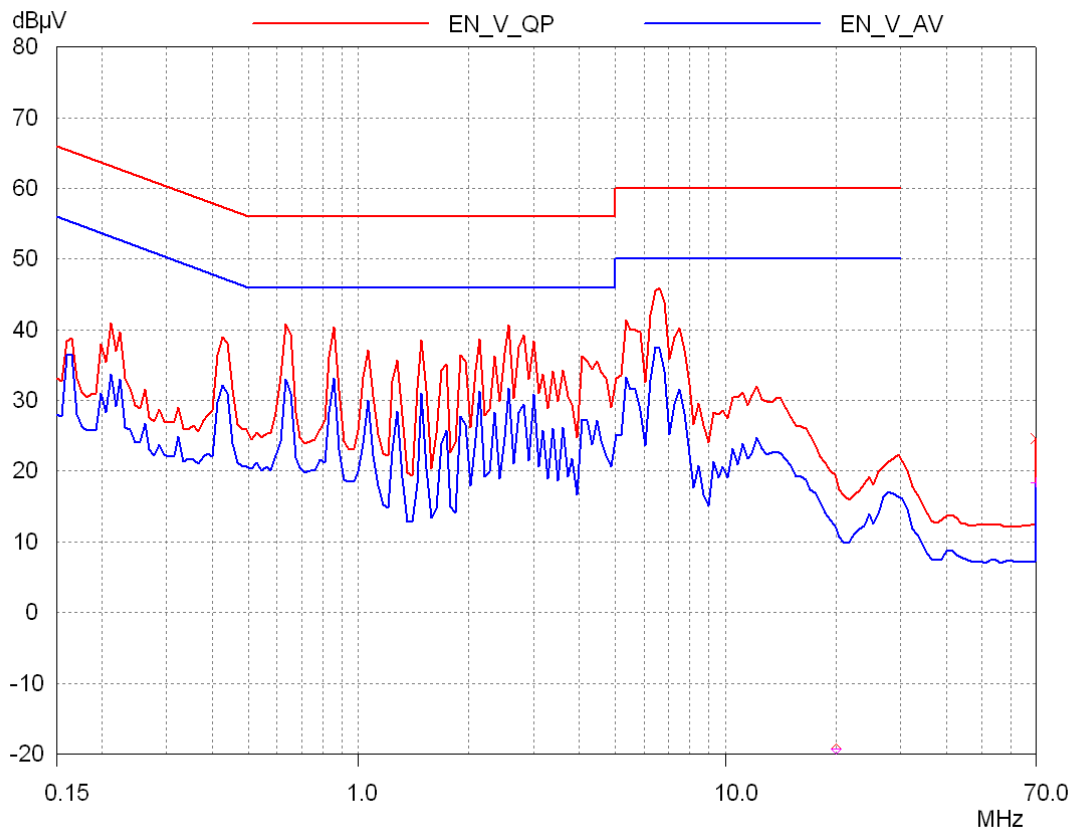

Figure 27 – No Y Capacitor Conducted EMI (230 VAC).

15 Revision History

Date	Author	Revision	Description & changes
01-Mar-04	AO	0.1	First Draft
01-Apr-04		0.2	Transformer and layout change
05-Apr-04	PV	0.3	Applied correct template, updated circuit description
08-Apr-04	PV	0.4	Reinserted Figure 4 (didn't printout)
28-Apr-04	AO	0.5	Updated BOM, Spreadsheet, Schematic and Transformer
02-May-04	PV	0.6	4.3: Change R2 to R3, replace terminated with disabled 4.4: Added 1 V opto threshold 6: Corrected description of D6 Fig 4: Added filar to diagram
20-May-04	AO	0.7	Added output characteristic spec
27-May-04	PV	0.8	Updated PCB layout, charts corrected
16-June-04	PV	0.81	R10 part number corrected Figure 2 updated (Q1 shown as NPN not PNP)
24-June-04	PV	0.9	Reinserted final spreadsheet
25-Oct-04	PV	1.0	Appendix A added for no Y cap solution



Notes



Notes



For the latest updates, visit our website: www.powerint.com

Power Integrations may make changes to its products at any time. Power Integrations has no liability arising from your use of any information, device or circuit described herein nor does it convey any license under its patent rights or the rights of others. POWER INTEGRATIONS MAKES NO WARRANTIES HEREIN AND SPECIFICALLY DISCLAIMS ALL WARRANTIES INCLUDING, WITHOUT LIMITATION, THE IMPLIED WARRANTIES OF MERCHANTABILITY, FITNESS FOR A PARTICULAR PURPOSE, AND NON-INFRINGEMENT OF THIRD PARTY RIGHTS.

PATENT INFORMATION

The products and applications illustrated herein (including circuits external to the products and transformer construction) may be covered by one or more U.S. and foreign patents or potentially by pending U.S. and foreign patent applications assigned to Power Integrations. A complete list of Power Integrations' patents may be found at www.powerint.com.

The PI Logo, **TOPSwitch**, **TinySwitch**, **LinkSwitch**, **DPA-Switch** and **EcoSmart** are registered trademarks of Power Integrations. **PI Expert** and **PI FACTS** are trademarks of Power Integrations. © Copyright 2004, Power Integrations.

Power Integrations Worldwide Sales Support Locations

WORLD HEADQUARTERS

5245 Hellyer Avenue,
San Jose, CA 95138, USA
Main: +1-408-414-9200
Customer Service:
Phone: +1-408-414-9665
Fax: +1-408-414-9765
e-mail: usasales@powerint.com

GERMANY

Rueckertstrasse 3,
D-80336, Munich, Germany
Phone: +49-895-527-3910
Fax: +49-895-527-3920
e-mail: eurossales@powerint.com

JAPAN

Keihin-Tatemono 1st Bldg.
12-20 Shin-Yokohama,
2-Chome,
Kohoku-ku, Yokohama-shi,
Kanagawa 222-0033, Japan
Phone: +81-45-471-1021
Fax: +81-45-471-3717
e-mail: japansales@powerint.com

TAIWAN

5F-1, No. 316, Nei Hu Rd., Sec. 1
Nei Hu Dist.
Taipei, Taiwan 114, R.O.C.
Phone: +886-2-2659-4570
Fax: +886-2-2659-4550
e-mail: taiwansales@powerint.com

CHINA (SHANGHAI)

Rm 807-808A, Pacheer,
Commercial Centre,
555 Nanjing West Road,
Shanghai, 200041, China
Phone: +86-21-6215-5548
Fax: +86-21-6215-2468
e-mail: chinasales@powerint.com

INDIA (TECHNICAL SUPPORT)

Innovatech
261/A, Ground Floor
7th Main, 17th Cross,
Sadashivanagar
Bangalore 560080
Phone: +91-80-5113-8020
Fax: +91-80-5113-8023
e-mail: indiasales@powerint.com

KOREA

RM 602, 6FL
Korea City Air Terminal B/D,
159-6,
Samsung-Dong, Kangnam-Gu,
Seoul, Korea
Phone: +82-2-2016-6610
Fax: +82-2-2016-6630
e-mail: koreasales@powerint.com

UK (EUROPE & AFRICA HEADQUARTERS)

1st Floor, St. James's House
East Street
Farnham, Surrey GU9 7TJ
United Kingdom
Phone: +44 (0) 1252-730-140
Fax: +44 (0) 1252-727-689
e-mail: eurossales@powerint.com

CHINA (SHENZHEN)

Room 2206-2207, Block A,
Electronics Science & Technology
Bldg.,
2070 Shennan Zhong Road,
Shenzhen, Guangdong,
China, 518031
Phone: +86-755-8379-3243
Fax: +86-755-8379-5828
e-mail: chinasales@powerint.com

ITALY

Via Vittorio Veneto 12,
Bresso
Milano, 20091, Italy
Phone: +39-028-928-6001
Fax: +39-028-928-6009
e-mail: eurossales@powerint.com

SINGAPORE

51 Newton Road,
#15-08/10 Goldhill Plaza,
Singapore, 308900
Phone: +65-6358-2160
Fax: +65-6358-2015
e-mail: singaporesales@powerint.com

APPLICATIONS HOTLINE

World Wide +1-408-414-9660

APPLICATIONS FAX

World Wide +1-408-414-9760