

Single-Stage Power Factor Corrected Off-Line Switching Regulators

Features and Benefits

- Integrated on-width control circuit (it realizes high power factor by average current control)
- Integrated startup circuit (no external startup circuit necessary)
- Integrated soft-start circuit (reduces power stress during start-up on the incorporated power MOSFET and rectifier)
- Integrated bias assist circuit (improves the startup performance, suppresses V_{CC} voltage droop during operation, allows reduction of V_{CC} capacitor value as well as use of a ceramic capacitor)
- Integrated Leading Edge Blanking (LEB) circuit
- Integrated maximum on-time limit circuit
- Dual-chip structure, with an avalanche-guaranteed power MOSFET (allows simplified surge suppressing circuits)
- Protection features:
 - Overcurrent protection (OCP): pulse-by-pulse
 - Overvoltage protection (OVP): latched shutdown
 - Overload protection (OLP): latched shutdown
 - Thermal shutdown (TSD): latched shutdown

Package: 8-pin DIP



Not to scale

Description

LC5540LD series is a quasi-resonant topology switching power supply IC, designed for input capacitorless applications, and making it possible for systems to comply with the harmonics standard (IEC61000-3-2 class C). It incorporates separate controller and power MOSFET chips. The controller adapts the average current control method for realizing high power factors, and the quasi-resonant topology contributes to high efficiency and low EMI noise. The rich set of protection features helps to realize low component counts, and high performance-to-cost power supply.

The LC5540LD devices are intended for isolated designs. The incorporated MOSFET has a V_{DSS(min)} rating from 650 V (LC5545LD and LC5546LD) to 800 V (LC5548LD). The R_{DS(on)(max)} is 1.9 Ω (LC5546LD) to 3.95 Ω (LC5545LD). It is capable of a maximum output power of 20 W on 230 VAC supply to 16 W on universal supply (LC5546LD) based on the thermal rating. Note that the maximum output power can be up to 120% to 140% of this value. However, it may be limited in applications with low output voltage or short duty cycle.

Applications

- LED lighting fixtures
- LED light bulbs

Typical Application

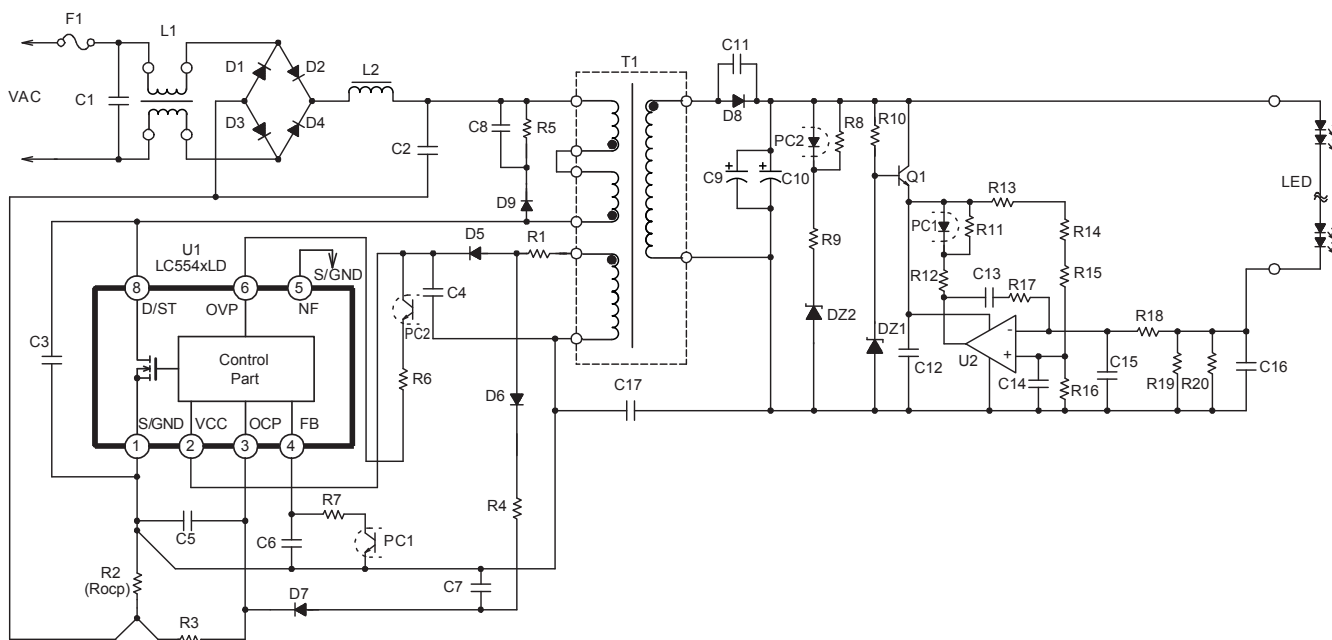

LC5540LD Series

Single-Stage Power Factor Corrected Off-Line Switching Regulators

Selection Guide

Part Number	MOSFET $V_{DS(s)}$ (min) (V)	$R_{DS(on)}$ (max) (Ω)	PWM Operation Frequency, $f_{osc}(typ)$ (kHz)	On-Time $t_{ON(MAX)}(typ)$ (μ s)	P_{OUT}^* (W)	
					230 VAC	Universal
LC5545LD	650	3.95	72	9.3	13	10
LC5546LD		1.9	60	11.2	20	16
LC5548LD	800	3.5	72	9.3	13	10

*Based on the thermal rating; the allowable maximum output power can be up to 120% to 140% of this value. However, maximum output power may be limited in such an application with low output voltage or short duty cycle.

The polarity value for current specifies a sink as "+," and a source as "–," referencing the IC.

Absolute Maximum Ratings Unless specifically noted, T_A is 25°C

Characteristic	Symbol	Notes	Pins	Rating	Unit
Drain Current ¹	I_{DPeak}	LC5545LD	8 – 1	2.5	A
		LC5546LD		4.0	A
		LC5548LD		2.6	A
Single Pulse Avalanche Energy ²	E_{AS}	LC5545LD	8 – 1	47	mJ
		LC5546LD		86	mJ
		LC5548LD		56	mJ
Input Voltage for Control Part (MIC)	V_{CC}		2 – 1	35	V
OCP Pin Voltage	V_{OCP}		3 – 1	–1.0 to 5.0	V
FB Pin Voltage	V_{FB}		4 – 1	–0.3 to 7.0	V
OVP Pin Voltage	V_{OVP}		6 – 1	–0.3 to 5.0	V
Allowable Power Dissipation of MOSFET ³	P_{D1}	Mounted on a 15 mm × 15 mm PCB	8 – 1	0.97	W
Operating Ambient Temperature	T_{OP}		—	–55 to 125	°C
Storage Temperature	T_{stg}		—	–55 to 125	°C
Channel Temperature	T_{ch}		—	150	°C

¹Refer to MOSFET Safe Operating Area Curve.

²Refer to MOSFET Avalanche Energy Derating Coefficient Curve.

³Refer to MOSFET Temperature versus Power Dissipation Curve.

LC5540LD Series

Single-Stage Power Factor Corrected Off-Line Switching Regulators

Electrical Characteristics of Control Part (MIC) $T_A = 25^\circ\text{C}$, $V_{CC} = 20\text{ V}$, unless otherwise specified

Characteristic	Symbol	Test Conditions	Pins	Min.	Typ.	Max.	Unit
Power Supply Startup Operation							
Operation Start Voltage	$V_{CC(ON)}$		2 – 1	13.8	15.1	17.3	V
Operation Stop Voltage*	$V_{CC(OFF)}$		2 – 1	8.4	9.4	10.7	V
Circuit Current in Operation	$I_{CC(ON)}$		2 – 1	–	–	4.7	mA
Startup Circuit Operation Voltage	$V_{STARTUP}$		8 – 1	18	21	24	V
Startup Current	$I_{CC(STARTUP)}$	$V_{CC} = 13\text{ V}$	2 – 1	–8.5	–4.0	–1.5	mA
Startup Current Threshold Biasing Voltage*	$V_{CC(BIAS)}$		2 – 1	9.5	11.0	12.5	V
Normal Operation							
PWM Operation Frequency	f_{OSC}	LC5545LD	8 – 1	60	72	84	kHz
		LC5546LD		50	60	70	kHz
		LC5548LD		60	72	84	kHz
Maximum On-Time	$t_{ON(MAX)}$	LC5545LD	8 – 1	8.0	9.3	11.2	μs
		LC5546LD		9.0	11.2	13.4	μs
		LC5548LD		8.0	9.3	11.2	μs
FB Pin Control Minimum Voltage	$V_{FB(MIN)}$		4 – 1	0.50	0.85	1.20	V
Maximum Feedback Current	$I_{FB(MAX)}$		4 – 1	–40	–25	–10	μA
Leading Edge Blanking Time	$t_{ON(LEB)}$		3 – 1	–	600	–	ns
Quasi-Resonant Operation Threshold Voltage-1	$V_{BD(TH1)}$		3 – 1	0.14	0.24	0.34	V
Quasi-Resonant Operation Threshold Voltage-2	$V_{BD(TH2)}$		3 – 1	0.11	0.16	0.21	V
Protected Operation							
OCP Pin Overcurrent Protection (OCP) Threshold Voltage	V_{OCP}		3 – 1	–0.66	–0.60	–0.54	V
OCP Pin Source Current	I_{OCP}		3 – 1	–120	–40	–10	μA
OCP Pin Overvoltage Protection (OVP) Operation Voltage	$V_{BD(OVP)}$		3 – 1	2.2	2.6	3.0	V
Overload Protection (OLP) Threshold Voltage	$V_{FB(OLP)}$		4 – 1	4.1	4.5	4.9	V
OVP Pin OVP Threshold Voltage	$V_{OVP(OVP)}$		6 – 1	1.6	2.0	2.4	V
VCC Pin OVP Threshold Voltage	$V_{CC(OVP)}$		2 – 1	28.5	31.5	34.0	V
Thermal Shutdown Activating Temperature	$T_{J(TSD)}$		–	135	–	–	$^\circ\text{C}$

* $V_{CC(BIAS)} > V_{CC(OFF)}$ always.

ELECTRICAL CHARACTERISTICS (MOSFET) $T_A = 25^\circ\text{C}$, unless otherwise specified

Characteristic	Symbol	Test Conditions		Pins	Min.	Typ.	Max.	Unit
Drain-to-Source Breakdown Voltage	V_{DSS}	LC5545LD		8 – 1	650	—	—	V
		LC5546LD			650	—	—	V
		LC5548LD			800	—	—	V
Drain Leakage Current	I_{DSS}			8 – 1	—	—	300	μA
On-Resistance	$R_{DS(ON)}$	LC5545LD		8 – 1	—	—	3.95	Ω
		LC5546LD			—	—	1.9	Ω
		LC5548LD			—	—	3.5	Ω
Switching Time	t_r	LC5545LD		8 – 1	—	—	250	ns
		LC5546LD			—	—	400	ns
		LC5548LD			—	—	400	ns
Thermal Resistance	$R_{\theta\text{ch-c}}$	LC5545LD	Between channel and case; case temperature, T_C , measured at the center of the marking side	—	—	—	42	$^\circ\text{C/W}$
		LC5546LD			—	—	35.5	$^\circ\text{C/W}$
		LC5548LD			—	—	40	$^\circ\text{C/W}$

Characteristic Performance LC5545LD

S. O. A. Temperature Derating Coefficient Curve

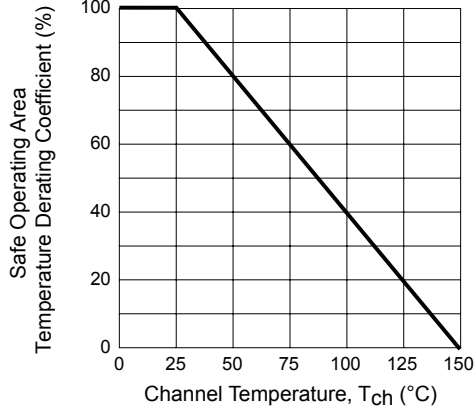

MOSFET Safe Operating Area Curve

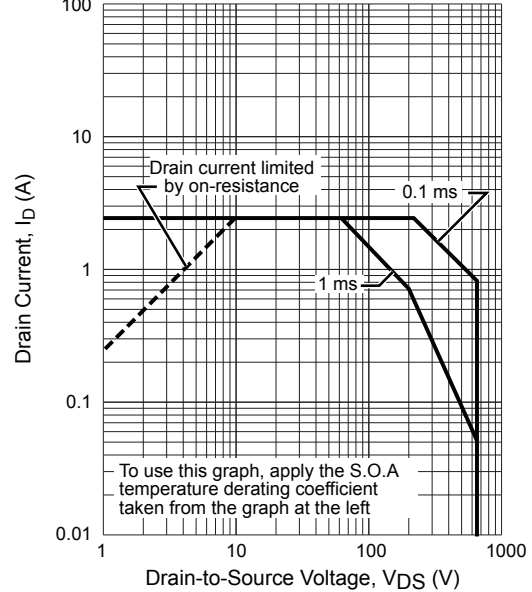

MOSFET Avalanche Energy Derating Coefficient Curve

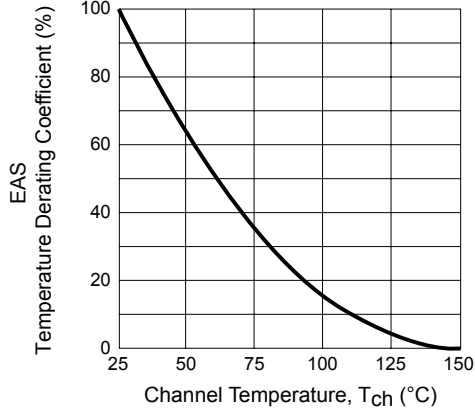

MOSFET Temperature versus Power Dissipation Curve

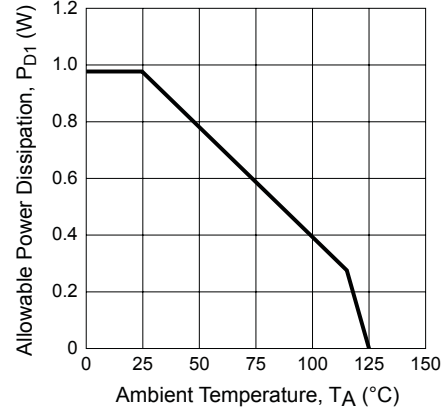

Transient Thermal Resistance Curve

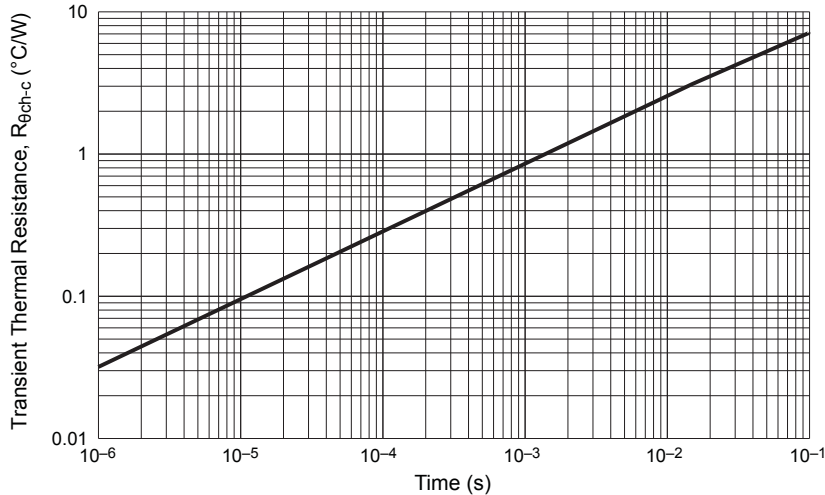

Characteristic Performance LC5546LD

S. O. A. Temperature Derating Coefficient Curve

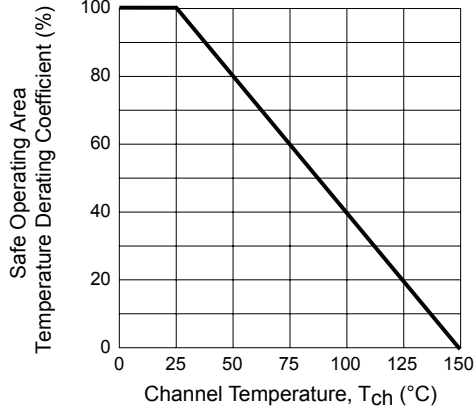

MOSFET Safe Operating Area Curve

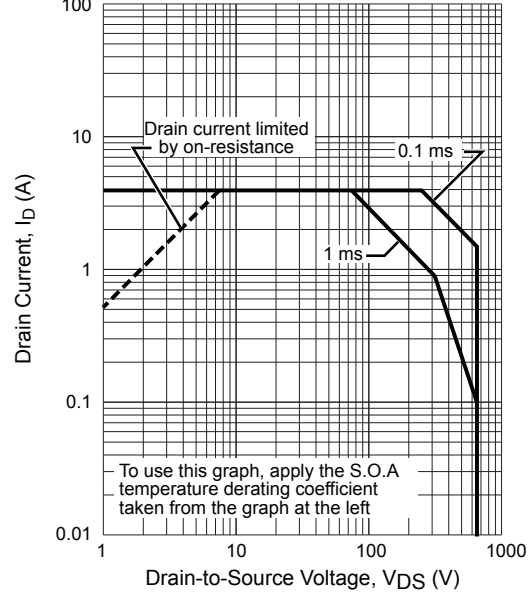

MOSFET Avalanche Energy Derating Coefficient Curve

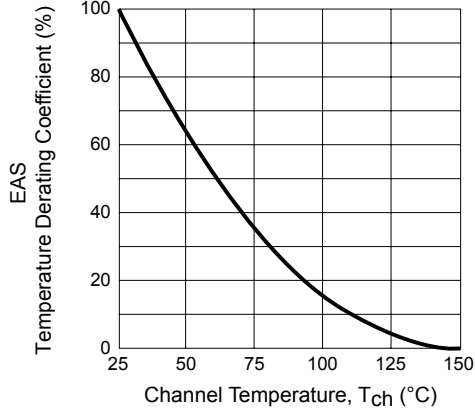

MOSFET Temperature versus Power Dissipation Curve

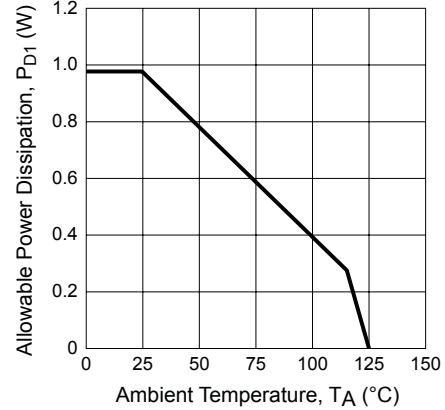

Transient Thermal Resistance Curve

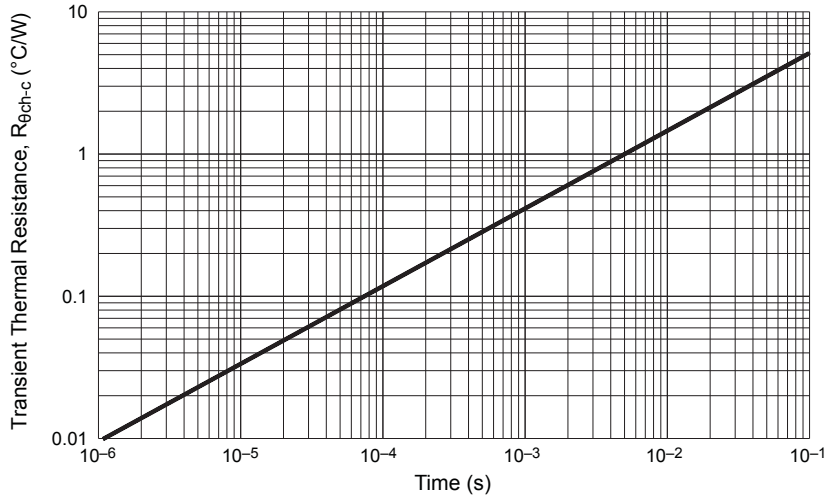

Characteristic Performance LC5548LD

S. O. A. Temperature Derating Coefficient Curve

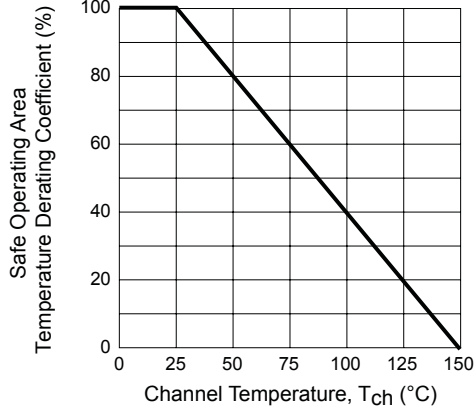

MOSFET Safe Operating Area Curve

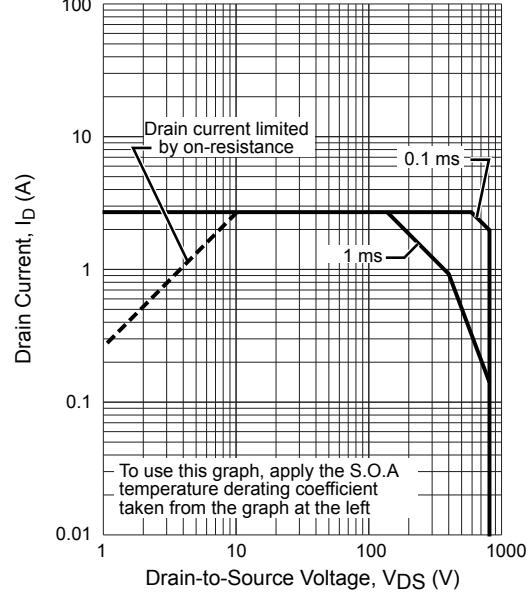

MOSFET Avalanche Energy Derating Coefficient Curve

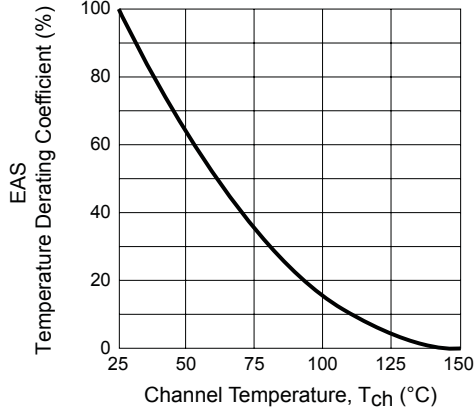

MOSFET Temperature versus Power Dissipation Curve

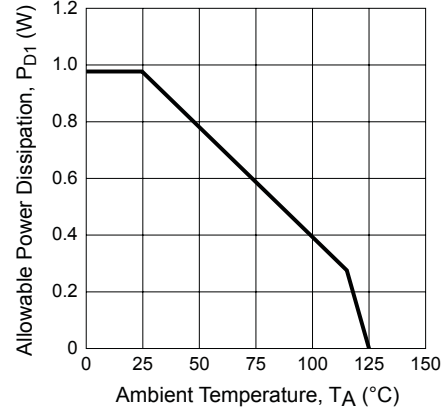

Transient Thermal Resistance Curve

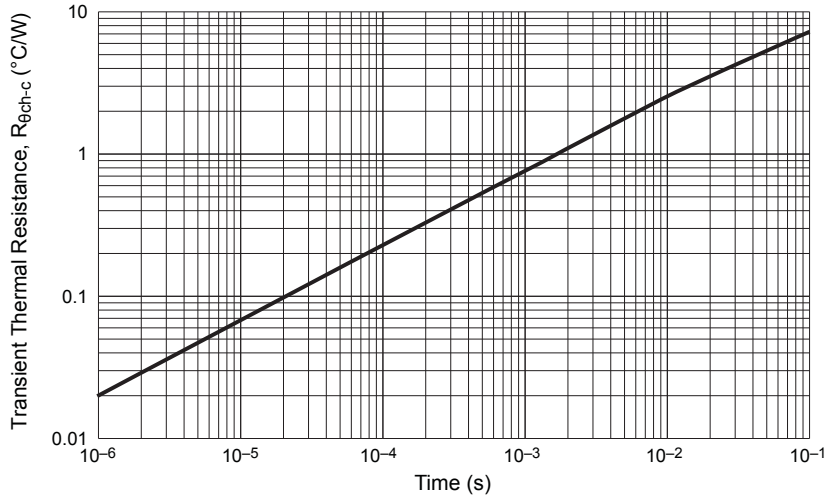

Functional Block Diagram

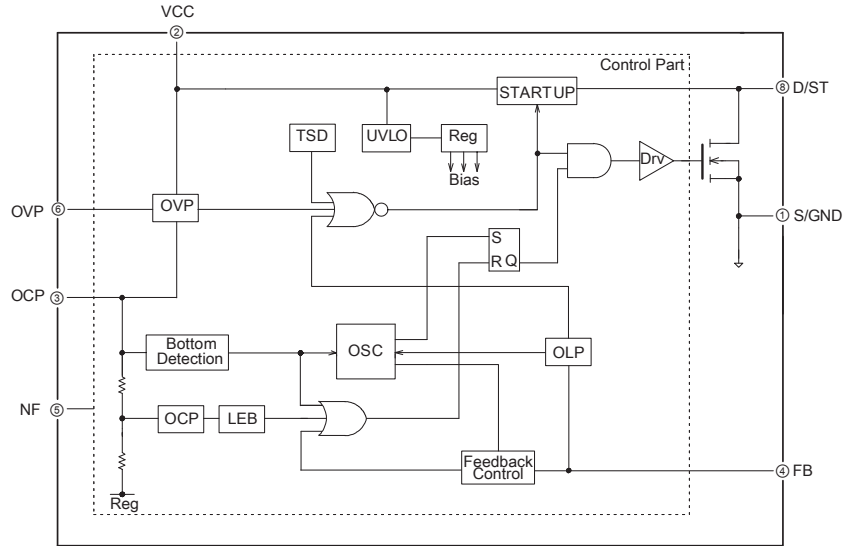

Pin List Table

Number	Name	Function
1	S/GND	MOSFET source and GND pin for the Control Part
2	VCC	Supply voltage input and Overvoltage Protection (OVP) signal input
3	OCP	Overcurrent Protection (OCP), quasi-resonant signal input, and Overvoltage Protection (OVP) signal input
4	FB	Feedback phase-compensation input and Overload Protection (OLP) signal input
5	NF	No function; must be externally connected to S/GND pin with as short a trace as possible, for stable operation of the IC
6	OVP	Overvoltage Protection (OVP) signal input
7	—	Pin removed
8	D/ST	MOSFET drain pin and input of the startup current

Pin-out Diagram

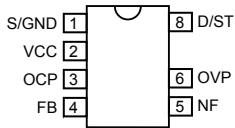

LC5540LD Series

Single-Stage Power Factor Corrected Off-Line Switching Regulators

Package Outline Drawing, DIP8

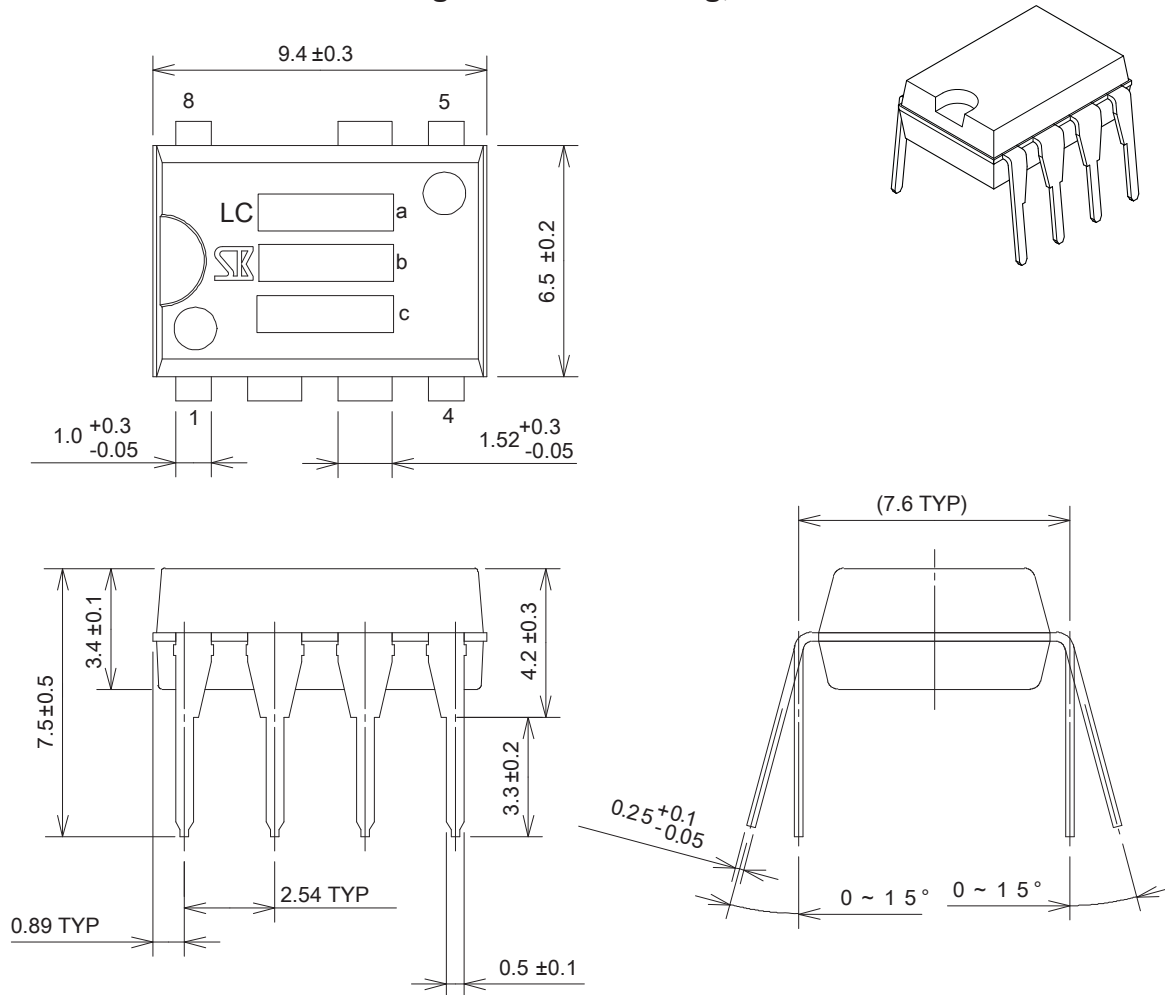

Unit: mm
Leadframe Material: Cu
Pin treatment: Solder Plating
Weight: Approximately 0.51g

a: Part #: 554x
b: Lot number 3 digits, plus L
1st letter: Last digit of year
2nd letter: Month
Jan to September: Numeric
October: O
November: N
December: D
3rd letter: Week
Date 1 to 10: 1
Date 11 to 20: 2
Date 21 to 31: 3
c: Internal use control number



*Pb-free. Device composition compliant
with the RoHS directive.*

Because reliability can be affected adversely by improper storage environments and handling methods, please observe the following cautions.

Cautions for Storage

- Ensure that storage conditions comply with the standard temperature (5°C to 35°C) and the standard relative humidity (around 40% to 75%); avoid storage locations that experience extreme changes in temperature or humidity.
- Avoid locations where dust or harmful gases are present and avoid direct sunlight.
- Reinspect for rust on leads and solderability of products that have been stored for a long time.

Cautions for Testing and Handling

When tests are carried out during inspection testing and other standard test periods, protect the products from power surges from the testing device, shorts between the product pins, and wrong connections.

Remarks About Using Silicone Grease with a Heatsink

- When silicone grease is used in mounting this product on a heatsink, it shall be applied evenly and thinly. If more silicone grease than required is applied, it may produce excess stress.
- Volatile-type silicone greases may crack after long periods of time, resulting in reduced heat radiation effect. Silicone grease with low consistency (hard grease) may cause cracks in the mold resin when screwing the product to a heatsink.
- Our recommended silicone greases for heat radiation purposes, which will not cause any adverse effect on the product life, are indicated below:

Type	Suppliers
G746	Shin-Etsu Chemical Co., Ltd.
YG6260	MOMENTIVE Performance Materials, Inc
SC102	Dow Corning Toray Co., Ltd.

Soldering

- When soldering the products, please be sure to minimize the working time, within the following limits:
260±5°C 10±1 s (Flow, 2 times)
380±10°C 3.5±0.5 s (Solder iron, 1 time)
- Soldering iron should be at a distance of at least 1.5 mm from the body of the products

Electrostatic Discharge

- When handling the products, the operator must be grounded. Grounded wrist straps worn should have at least 1 MΩ of resistance from the operator to ground to prevent shock hazard, and it should be placed near the operator.
- Workbenches where the products are handled should be grounded and be provided with conductive table and floor mats.
- When using measuring equipment such as a curve tracer, the equipment should be grounded.
- When soldering the products, the head of soldering irons or the solder bath must be grounded in order to prevent leak voltages generated by them from being applied to the products.
- The products should always be stored and transported in Sanken shipping containers or conductive containers, or be wrapped in aluminum foil.

- The contents in this document are subject to changes, for improvement and other purposes, without notice. Make sure that this is the latest revision of the document before use.
- Application and operation examples described in this document are quoted for the sole purpose of reference for the use of the products herein and Sanken can assume no responsibility for any infringement of industrial property rights, intellectual property rights or any other rights of Sanken or any third party which may result from its use.
- Although Sanken undertakes to enhance the quality and reliability of its products, the occurrence of failure and defect of semiconductor products at a certain rate is inevitable. Users of Sanken products are requested to take, at their own risk, preventative measures including safety design of the equipment or systems against any possible injury, death, fires or damages to the society due to device failure or malfunction.
- Sanken products listed in this document are designed and intended for the use as components in general purpose electronic equipment or apparatus (home appliances, office equipment, telecommunication equipment, measuring equipment, etc.).
When considering the use of Sanken products in the applications where higher reliability is required (transportation equipment and its control systems, traffic signal control systems or equipment, fire/crime alarm systems, various safety devices, etc.), and whenever long life expectancy is required even in general purpose electronic equipment or apparatus, please contact your nearest Sanken sales representative to discuss, prior to the use of the products herein.
The use of Sanken products without the written consent of Sanken in the applications where extremely high reliability is required (aerospace equipment, nuclear power control systems, life support systems, etc.) is strictly prohibited.
- In the case that you use our semiconductor devices or design your products by using our semiconductor devices, the reliability largely depends on the degree of derating to be made to the rated values. Derating may be interpreted as a case that an operation range is set by derating the load from each rated value or surge voltage or noise is considered for derating in order to assure or improve the reliability. In general, derating factors include electric stresses such as electric voltage, electric current, electric power etc., environmental stresses such as ambient temperature, humidity etc. and thermal stress caused due to self-heating of semiconductor devices. For these stresses, instantaneous values, maximum values and minimum values must be taken into consideration.
In addition, it should be noted that since power devices or IC's including power devices have large self-heating value, the degree of derating of junction temperature (T_j) affects the reliability significantly.
- When using the products specified herein by either (i) combining other products or materials therewith or (ii) physically, chemically or otherwise processing or treating the products, please duly consider all possible risks that may result from all such uses in advance and proceed therewith at your own responsibility.
- Anti radioactive ray design is not considered for the products listed herein.
- Sanken assumes no responsibility for any troubles, such as dropping products caused during transportation out of Sanken's distribution network.
- The contents in this document must not be transcribed or copied without Sanken's written consent.