

PLEASE CHECK WWW.MOLEX.COM FOR LATEST PART INFORMATION

Part Number: **0334821602**
Status: **Active**
Overview: mx150 sealed connector system
Description: 3.50mm (.138") Pitch MX150™ Sealed Male Connector, Dual Row, 16 Circuits, Polarization B, without Connector Position Assurance, Gray

Documents:

[3D Model](#)
[Application Specification \(PDF\)](#)
[Drawing \(PDF\)](#)
[Product Specification PS-33472-000 \(PDF\)](#)
[RoHS Certificate of Compliance \(PDF\)](#)

General

Product Family	Crimp Housings
Series	<u>33482</u>
Comments	No Connector Position Assurance (CPA)
More Detailed Tech Information	http://ewcap.uscarteams.org
Overview	<u>mx150 sealed connector system</u>
Product Name	MX150™

Physical

Circuits (maximum)	16
Circuits Detail	16
Color - Resin	Black, Gray (Light), Natural
Gender	Male
Glow-Wire Compliant	No
Keying to Mating Part	Yes
Lock to Mating Part	Yes
Material - Resin	Modified Polystyrene Alloy
Number of Rows	2
Packaging Type	Bag
Panel Mount	No
Pitch - Mating Interface (in)	0.138 In
Pitch - Mating Interface (mm)	3.50 mm
Polarized to Mating Part	Yes
Stackable	No
Temperature Range - Operating	-40°C to +125°C

Electrical

Current - Maximum per Contact	22A
-------------------------------	-----

Material Info

Reference - Drawing Numbers

Application Specification	AS-33472-100
Packaging Specification	PK-30907-811, PK-31300-635
Product Specification	PS-33472-000
Sales Drawing	SD-33482-161



EU RoHS

ELV and RoHS Compliant
REACH SVHC Contains SVHC: No
Halogen-Free Status
Not Reviewed

China RoHS



Need more information on product environmental compliance?

Email productcompliance@molex.com
 For a multiple part number RoHS Certificate of Compliance, [click here](#)

Please visit the [Contact Us](#) section for any non-product compliance questions.

Search Parts in this Series

33482Series

Mates With

33472 Female Dual Row Sealed Connector

Use With

33000 MX150™ Tin (Sn) Male Terminal,
33011 Gold (Au) Male Terminal

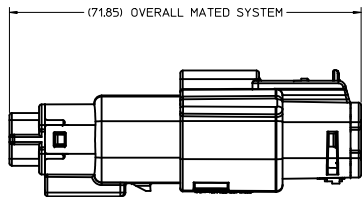

SCALE 1:1

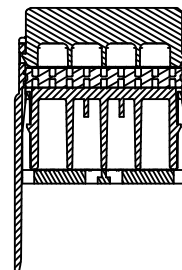
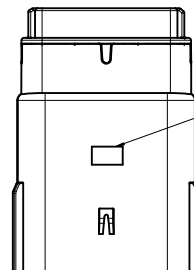
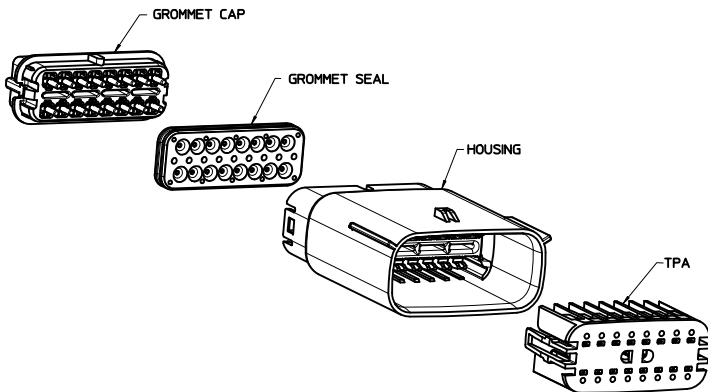

SECTION A-A

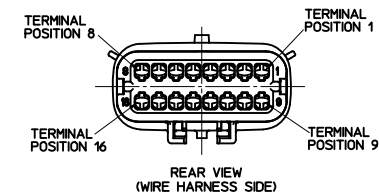

REAR VIEW
(WIRE HARNESS SIDE)

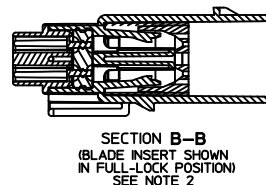

SECTION B-B
(BLADE INSERT SHOWN
IN FULL-LOCK POSITION)
SEE NOTE 2

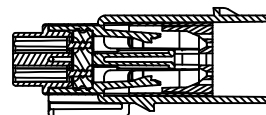

SECTION E-E
(BLADE INSERT SHOWN
IN PRE-LOCK POSITION)
SEE NOTE 2

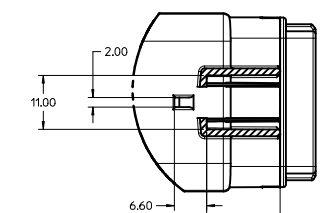
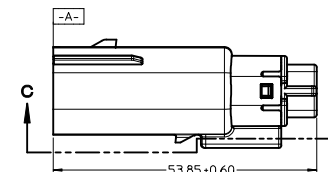
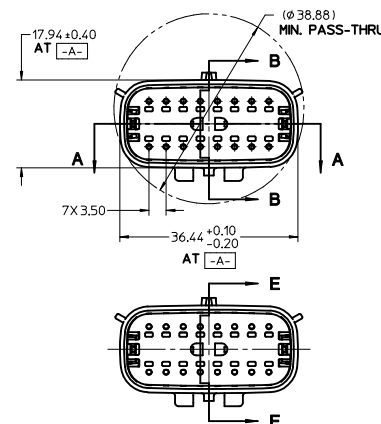

SECTION C-C

NOTES: UNLESS OTHERWISE STATED

- DESIGNED TO MATE WITH RECEPTACLE HOUSING ASSEMBLY SPECIFIED IN MOLEX CHARTED DRAWING SD-33472-161.
- ASSEMBLY SHIPPED WITH BLADE INSERT IN PRE-LOCKED POSITION (SEE SECTION E-E PRE-LOCK). UPON FULL TERMINAL ASSEMBLY EACH BLADE INSERT MUST BE SNAPPED INTO ITS FINAL-LOCK POSITION.
- FOR BLADE TERMINALS TO BE USED WITH THIS ASSEMBLY SEE DRAWING SD-33000-001.
- SYSTEM TO BE USED WITH WIRE WITHIN DIAMETER RANGE OF 1.5mm TO 2.5mm.
- MATERIAL: SPS/NYLON BLEND, 20% GLASS FILLED.
- SHALL CONFORM TO PACKAGING SPECIFICATION PK-31300-635.
- SHALL CONFORM TO PRODUCT SPECIFICATION PS-33472-000.
- ASSEMBLY CONFORMS TO SAE/USCAR-2 REV 4 WITH THE FOLLOWING EXCEPTIONS: TERMINAL INSERTION FORCE FOR WIRE SIZE ABOVE 2.5mm NOT EXCEEDING 2.69mm SHALL NOT EXCEED 45 NEWTONS.

ENTER DESCRIPTION IEC NO. UAU2010-1593 DRAWN BY CHKD BY APPR. BY DATE 2010/03/30 2010/03/30 2010/04/06	QUALITY SYMBOLS ∇=0 ∇=0 ∇=0	GENERAL TOLERANCES (UNLESS SPECIFIED) mm INCH		DIMENSION STYLE MM ONLY	SCALE 2:1	DESIGN UNITS METRIC	THIRD ANGLE PROJECTION
		4 PLACES ± .10 3 PLACES ± .15 2 PLACES ± 0.10 1 PLACE ± 0.3	4 PLACES ± .004 3 PLACES ± .005 2 PLACES ± 0.004 1 PLACE ± 0.008	DRAWN BY DGRIFITHS	DATE 05-29-03	TITLE MX150 BLADE CONNECTOR ASSEMBLY 2 ROW SEALED, 16 WAY	MOLEX INCORPORATED
DRAFT WHERE APPLICABLE MUST REMAIN WITHIN DIMENSIONS	MATERIAL NO. SEE TABLE	DATE 2010/04/06	APPROVED BY VKOSHY	DOCUMENT NO. SD-33482-161	SHEET NO. 1 OF 3	THIS DRAWING CONTAINS INFORMATION THAT IS PROPRIETARY TO MOLEX INCORPORATED AND SHOULD NOT BE USED WITHOUT WRITTEN PERMISSION	

ASSEMBLY PART NUMBER	COLOR	KEYING OPTION	DIMENSIONS (DEGREES)		CAVITY TYPE & STATUS (X = PLUGGED)															
			A	B	1	2	3	4	5	6	7	8	9	10	11	12	13	14	15	16
33482-1601	BLACK	A	60	60																
33482-1602	LT.GRAY	B	25	60																
33482-1603	BROWN	C	60	25																
33482-1604	GREEN	D	25	25																
33482-1605	CUSTOM	TBD																		
33482-1606	BLACK	A	60	60									X							
33482-1607	LT.GRAY	B	25	60									X							
33482-1608	BROWN	C	60	25									X							
33482-1609	GREEN	D	25	25									X							
33482-1610	CUSTOM	TBD											X							
33482-1611	BLACK	A	60	60									X	X						
33482-1612	LT.GRAY	B	25	60									X	X						
33482-1613	BROWN	C	60	25									X	X						
33482-1614	GREEN	D	25	25									X	X						
33482-1615	CUSTOM	TBD											X	X						
33482-1616	BLACK	A	60	60	X								X	X						
33482-1617	LT.GRAY	B	25	60	X								X	X						
33482-1618	BROWN	C	60	25	X								X	X						
33482-1619	GREEN	D	25	25	X								X	X						
33482-1620	CUSTOM	TBD			X								X	X						
33482-1621	BLACK	A	60	60	X	X	X	X	X	X	X	X	X	X	X	X	X	X	X	X
33482-1622	LT.GRAY	B	25	60	X	X	X	X	X	X	X	X	X	X	X	X	X	X	X	X
33482-1623	BROWN	C	60	25	X	X	X	X	X	X	X	X	X	X	X	X	X	X	X	X
33482-1624	GREEN	D	25	25	X	X	X	X	X	X	X	X	X	X	X	X	X	X	X	X
33482-1625	CUSTOM	TBD			X	X	X	X	X	X	X	X	X	X	X	X	X	X	X	X
33482-1626	BLACK	A	60	60															X	
33482-1627	BLACK	A	60	60	X								X	X						X
33482-1628	LT.GRAY	B	25	60	X								X	X						X
33482-1629	BROWN	C	60	25	X								X	X						X
33482-1630	GREEN	D	25	25	X								X	X						X
33482-1631	CUSTOM	TBD			X								X	X						X
33482-1632	BLACK	A	60	60				X					X	X		X	X	X		
33482-1633	BLACK	A	60	60			X	X	X				X	X	X	X	X	X	X	X
33482-1634	BLACK	A	60	60								X	X		X	X				
33482-1635	LT.GRAY	B	25	60								X	X			X	X	X	X	
33482-1636	BLACK	A	60	60								X	X		X	X	X	X		
33482-1637	BLACK	A	60	60								X	X						X	
33482-1638	BLACK	A	60	60								X	X	X	X				X	X
33482-1639	BLACK	A	60	60															X	
33482-1640	BLACK	A	60	60					X											X
33482-1641	BLACK	A	60	60					X											
33482-1642	LT.GRAY	B	25	60			X		X	X	X			X		X				
33482-1643	BLACK	A	60	60															X	X
33482-1644	LT.GRAY	B	25	60			X													
33482-1645	LT.GRAY	B	25	60			X		X	X	X									
33482-1646	BLACK	A	60	60			X		X	X	X				X					
33482-1647	BLACK	A	60	60																X
33482-1648	BLACK	A	60	60			X							X						
33482-1649	LT.GRAY	B	25	60																X
33482-1650	LT.GRAY	B	25	60				X						X		X				

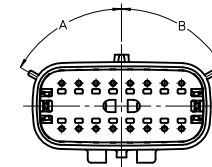

KEYING OPTION
SEE TABLE
SCALE 2:1

ENTER DESCRIPTION ELEC NO: UAU2010-1593 DRAWN BY: CHKO/SYERZYL APPR: VKOSHY 2010/03/30 2010/04/06	QUALITY SYMBOLS ∇=0 ∇=0 ∇=0	GENERAL TOLERANCES (UNLESS SPECIFIED) mm INCH		DIMENSION STYLE MM ONLY		SCALE 2:1	DESIGN UNITS METRIC	THIRD ANGLE PROJECTION	
		4 PLACES ±---	±---	DRAWN BY	DATE	TITLE MX150 BLADE CONNECTOR ASSEMBLY 2 ROW SEALED, 16 WAY			
		3 PLACES ±---	±---	CHECKED BY	DATE	MOLEX INCORPORATED			
		2 PLACES ±0.10	±---	APPROVED BY	DATE	MATERIAL NO. SD-33482-161 DOCUMENT NO. 2 OF 3			
DRAFT WHERE APPLICABLE MUST REMAIN WITHIN DIMENSIONS		ANGULAR ± 3°		SIZE D		THIS DRAWING CONTAINS INFORMATION THAT IS PROPRIETARY TO MOLEX INCORPORATED AND SHOULD NOT BE USED WITHOUT WRITTEN PERMISSION			

ASSEMBLY PART NUMBER	COLOR	KEYING OPTION	DIMENSIONS (DEGREES)		CAVITY TYPE & STATUS (X = PLUGGED)															
			A	B	1	2	3	4	5	6	7	8	9	10	11	12	13	14	15	16
33482-1651	LT.GRAY	B	25	60														X		
33482-1652	LT.GRAY	B	25	60						X	X	X						X		
33482-1653	BLACK	A	60	60								X						X		
33482-1654	BLACK	A	60	60				X				X			X					
33482-1655	LT.GRAY	B	25	60				X				X			X			X		
33482-1656	LT.GRAY	B	25	60								X						X		
33482-1657	BLACK	A	60	60	X							X								
33482-1658	LT.GRAY	B	25	60		X		X		X	X	X			X			X		
33482-1659	LT.GRAY	B	25	60		X				X	X	X						X		
33482-1660	LT.GRAY	B	25	60		X						X						X		
33482-1661	BLACK	A	60	60		X		X				X					X			
33482-1662	LT.GRAY	B	25	60		X		X				X					X			
33482-1663	BLACK	A	60	60		X						X								
33482-1664	BLACK	A	60	60			X					X	X					X	X	
33482-1665	BLACK	A	60	60			X	X	X	X	X	X	X	X				X	X	
33482-1666	BLACK	A	60	60		X				X	X	X					X	X	X	
33482-1667	BLACK	A	60	60		X			X	X		X				X	X	X	X	
33482-1668	BLACK	A	60	60		X			X	X		X	X			X	X	X	X	
33482-1669	BLACK	A	60	60		X			X			X				X	X			
33482-1670	BLACK	A	60	60		X		X	X	X	X	X	X	X	X	X	X	X	X	
33482-1671	BLACK	A	60	60		X		X	X	X		X			X	X	X	X	X	
33482-1672	BLACK	A	60	60			X				X									
33482-1673	BLACK	A	60	60		X				X	X	X								
33482-1674	BLACK	A	60	60		X				X	X									
33482-1675	BLACK	A	60	60		X				X	X			X						
33482-1676	BLACK	A	60	60					X	X	X	X								
33482-1677	BLACK	A	60	60					X	X	X	X		X			X			
33482-1678	BLACK	A	60	60					X	X	X	X		X	X	X				
33482-1679	BLACK	A	60	60					X	X	X	X		X	X	X	X			
33482-1680	BLACK	A	60	60					X	X	X	X		X	X	X	X	X		
33482-1681	BLACK	A	60	60							X							X		
33482-1682	BLACK	A	60	60					X	X	X							X	X	
33482-1683	BLACK	A	60	60					X	X	X	X						X	X	
33482-1684	BLACK	A	60	60	X	X	X	X	X	X	X					X	X	X	X	
33482-1685	BLACK	A	60	60							X					X	X	X	X	
33482-1686	BLACK	A	60	60							X					X	X	X	X	
33482-1687	BLACK	A	60	60						X	X			X	X	X	X	X		
33482-1688	BLACK	A	60	60						X	X			X	X	X	X	X		
33482-1689	BLACK	A	60	60						X	X			X						
33482-1690	BLACK	A	60	60						X	X				X					
33482-1691	BLACK	A	60	60					X						X					
33482-1692	BLACK	A	60	60		X						X	X					X	X	
33482-1693	BLACK	A	60	60		X						X						X		
33482-1694	BLACK	A	60	60		X			X	X	X	X	X	X	X		X	X	X	
33482-1695	BLACK	A	60	60		X			X	X	X	X		X			X	X		
33482-1700	BLACK	A	60	60	X	X	X	X	X	X	X			X	X	X	X	X	X	
33482-1701	BLACK	A	60	60	X	X	X	X	X	X				X	X	X	X	X	X	
33482-1702	BLACK	A	60	60						X	X	X	X	X	X	X	X	X	X	
33482-1703	BLACK	A	60	60						X	X	X	X	X	X	X	X	X	X	
33482-1704	BLACK	A	60	60	X	X	X	X	X	X								X	X	
33482-1705	BLACK	A	60	60							X	X	X	X	X	X	X	X	X	
33482-1706	BLACK	A	60	60								X	X	X	X	X	X	X	X	
33482-1707	BLACK	A	60	60						X	X	X	X							
33482-1708	BLACK	A	60	60														X	X	
33482-1709	BLACK	A	60	60														X	X	
33482-1710	BLACK	A	60	60	X	X	X	X	X	X	X	X	X	X	X	X	X	X	X	

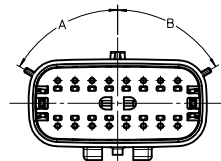

ENTER DESCRIPTION IEC NO: UAU2010-1593 DRAWN BY: 2010/03/30 CHKD: SVRZYL APPR: VKOSHY 2010/04/06 REV: AA	QUALITY SYMBOLS ∇=0 ∇=0 ∇=0	GENERAL TOLERANCES (UNLESS SPECIFIED) mm INCH 4 PLACES ±0.10 ±0.004 3 PLACES ±0.15 ±0.006 2 PLACES ±0.25 ±0.010 1 PLACE ±0.50 ±0.020 ANGULAR ± 3°	DIMENSION STYLE MM ONLY	SCALE 2:1 DESIGN UNITS METRIC THIRD ANGLE PROJECTION	DRAWN BY: DGR1FF DATE: 05-29-03 CHECKED BY: DGR1FF DATE: 05-29-03 APPROVED BY: VKOSHY DATE: 2010/04/06	MATERIAL NO. SEE TABLE DOCUMENT NO. SD-33482-161	TITLE: MX150 BLADE CONNECTOR ASSEMBLY 2 ROW SEALED, 16 WAY MOLEX INCORPORATED	SHEET NO. 3 OF 3
	DRAFT WHERE APPLICABLE MUST REMAIN WITHIN DIMENSIONS							
	THIS DRAWING CONTAINS INFORMATION THAT IS PROPRIETARY TO MOLEX INCORPORATED AND SHOULD NOT BE USED WITHOUT WRITTEN PERMISSION							
	SIZE D							