



YENYO

# HFR30A06

Glass Passivated Hyperfast Recovery Rectifier

## Features

- ★ Fast switching for high efficiency
- ★ Low noise
- ★  $T_{rr} = 40\text{ns}$
- ★ Low reverse leakage current
- ★ High voltage super FRD
- ★ PFC application

## Mechanical Data

- ★ Case: Molded plastic TO-220AC
- ★ Epoxy: UL 94V-0 rate flame retardant ,
- ★ Terminals: Solderable per MIL-STD-202 method 208
- ★ Mounting position: Any
- ★ Weight: 2.07 grams

**Voltage Range 600 V  
Current 30.0 Ampere**

## TO-220AC

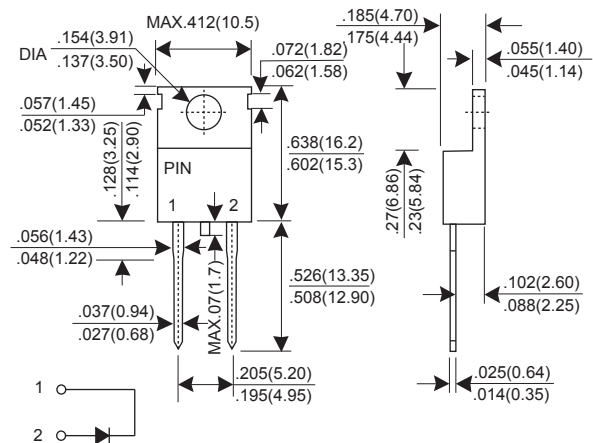

Dimensions in inches and (millimeters)

## MAXIMUM RATINGS AND ELECTRICAL CHARACTERISTICS

Rating at 25°C ambient temperature unless otherwise specified.

Single phase, half wave, 60Hz, resistive or inductive load.

For capacitive load, derate current by 20%.

CHARACTERISTIC	SYMBOL	HFR30A06			UNIT
		Min.	Typ.	Max.	
Recurrent Peak Reverse Voltage	VRRM	-	-	600	V
RMS Voltage	VRMS	-	-	420	V
DC Blocking Voltage	VDC	-	-	600	V
Average Forward Rectified Current $T_c=140^\circ\text{C}$	IF(AV)	-	-	30.0	A
Peak Forward Surge Current, 8.3ms single Half sine-wave superimposed on rated load (JEDEC method)	IFSM	-	-	325	A
Instantaneous Forward Voltage @30A(25°C) @30A(150°C)	VF	-	-	2.5 2.2	V
DC Reverse Current @ $T_J=25^\circ\text{C}$ At Rated DC Blocking Voltage @ $T_J=150^\circ\text{C}$	IR	-	-	20 500	uA
Maximum Reverse Recovery Time (Note 1)	Trr	-	-	40	nS
Maximum Reverse Recovery Time (Note 2)	Trr	-	-	65	nS
Typical junction Capacitance (Note 3)	CJ	-	60	-	pF
Typical Thermal Resistance (Note 4)	RθJC	-	-	1.5	°CW
Operating Junction and Storage Temperature Range	TJ, TSTG	-65	-	175	°C

NOTES : (1) Reverse recovery test conditions  $I_F = 0.5\text{A}$ ,  $I_R = 1.0\text{A}$ ,  $I_{rr} = 0.25\text{A}$ .  
 (2) Reverse recovery test conditions  $I_F = 15\text{A}$ ,  $diF/dt = 100\text{A/us}$   
 (3) Junction Capacitance test conditions :  $V_R = 10\text{V}$ ,  $I_F = 0\text{A}$ .  
 (4) Thermal Resistance junction to case.

# RATINGS AND CHARACTERISTIC CURVES HFR30A06

FIG.1 - FORWARD CURRENT DERATING CURVE

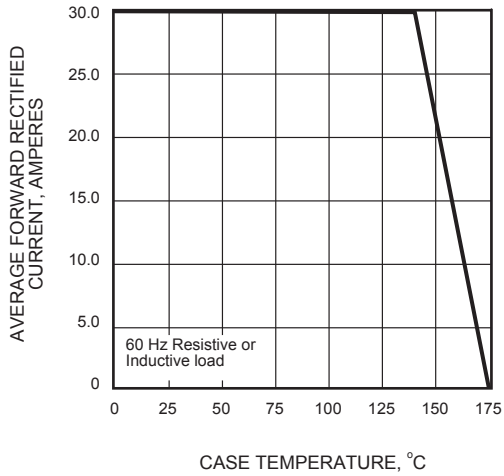

FIG.2 - MAXIMUM NON-REPETITIVE PEAK FORWARD SURGE CURRENT

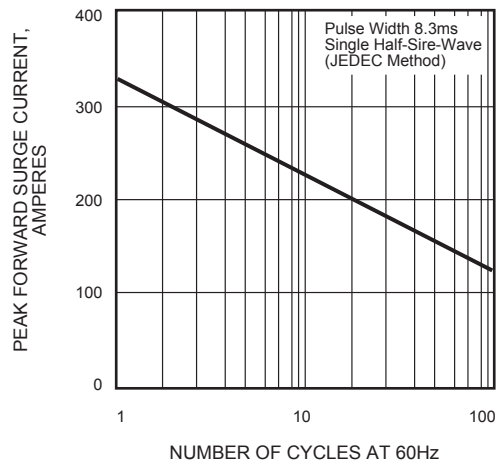

FIG.3 - TYPICAL INSTANTANEOUS FORWARD CHARACTERISTICS

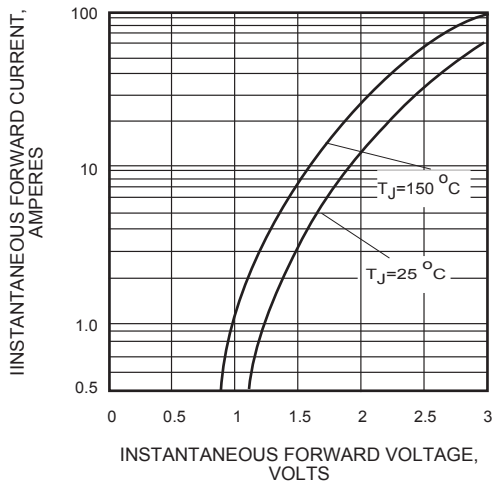

FIG.4 - TYPICAL REVERSE CHARACTERISTICS

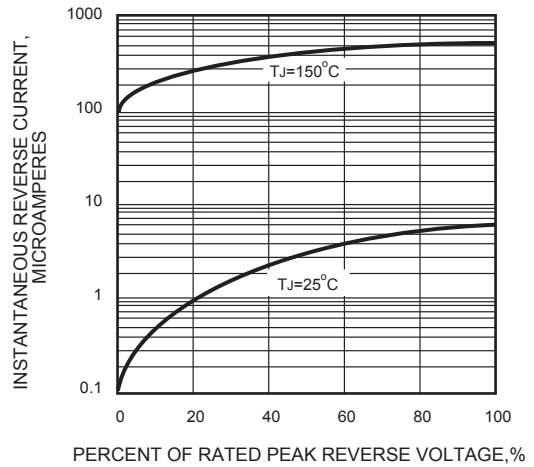

FIG.5 -  $t_{rr}$ ,  $t_a$  AND  $t_b$  CURVES vs FORWARD CURRENT

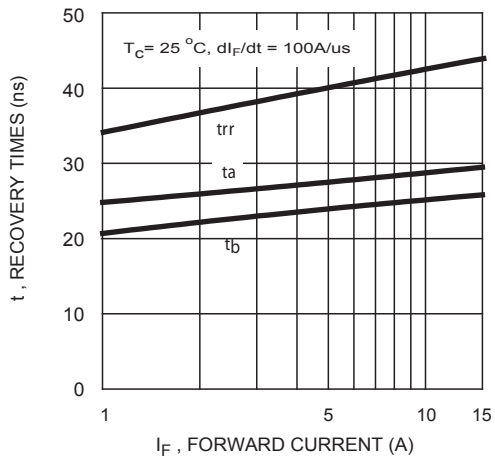
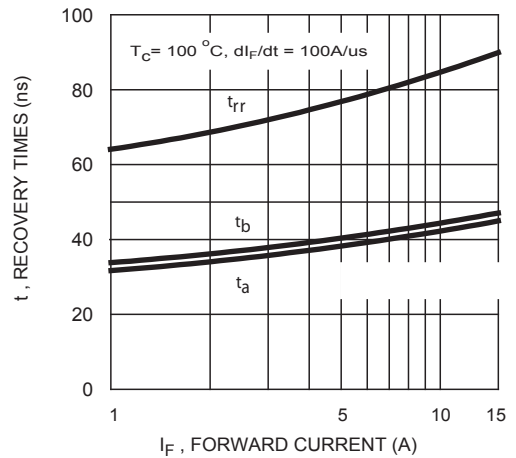

FIG.6 -  $t_{rr}$ ,  $t_a$  AND  $t_b$  CURVES vs FORWARD CURRENT



# RATINGS AND CHARACTERISTIC CURVES HFR30A06

FIG.7 -  $T_{rr}$ ,  $t_a$  AND  $t_b$  CURVES vs FORWARD CURRENT

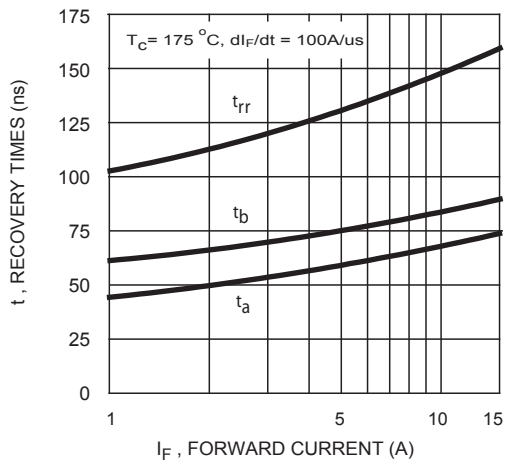
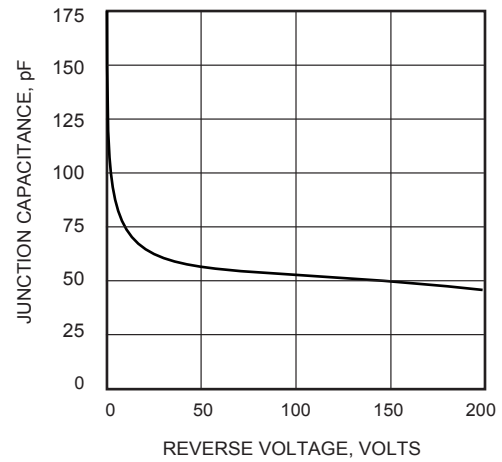

FIG.8 - TYPICAL JUNCTION CAPACITANCE



## Test Circuits and Waveforms

FIG.9 -  $t_{rr}$  TEST CIRCUIT

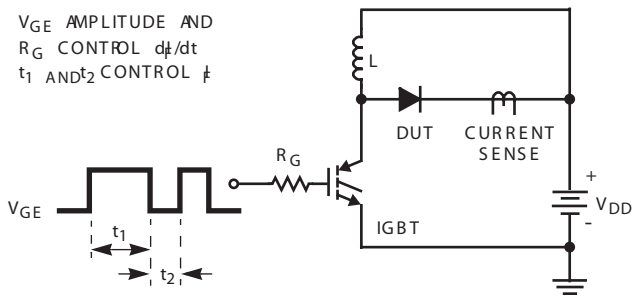

FIG.10  $t_{rr}$  WAVEFORMS AND DEFINITIONS

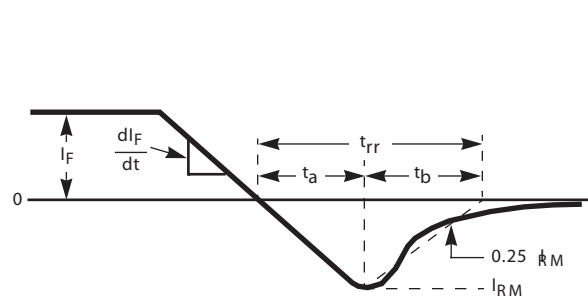

FIG.11 AVALANCHE ENERGY TEST CIRCUIT

$I_{MAX} = 1A$   
 $L = 40mH$   
 $R < 0.1$   
 $E_{AVL} = 1/2 L I_L^2 [V_{R(AVL)}/(V_{R(AVL)} - V_{DD})]$   
 $Q_1 = IGBT (BV_{ES} > DUVR(AVL))$

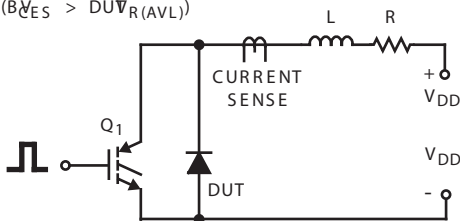

FIG.12 AVALANCHE CURRENT AND VOLTAGE WAVEFORMS

