

XC6213 Series



High Speed LDO Regulators, Low ESR Cap. Compatible, Ultra Small Package

- ◆ Input Voltage Range : 2.0 ~ 6.0V
- ◆ Output Voltage Range : 1.2 ~ 5.0V
- ◆ Output Current : 150mA
($V_{OUT}=3.0V$, $V_{IN}=4.0V$)
- ◆ Low ESR Capacitor Compatible
- ◆ Ultra Small Packages : SSOT-24
SOT-25 (SOT-23-5)
USP-4

GENERAL DESCRIPTION

The XC6213 series are highly precise, low noise, positive voltage LDO regulators manufactured using CMOS processes. The series achieves high ripple rejection and low dropout and consists of a voltage reference, an error amplifier, a current limiter and a phase compensation circuit plus a driver transistor. Output voltage is selectable in 50mV increments within a range of 1.2V ~ 5.0V.

The series is also compatible with low ESR ceramic capacitors, which give added output stability.

The current limiter's foldback circuit also operates as a short protect for the output current limiter and the output pin.

The CE function enables the output to be turned off, resulting in greatly reduced power consumption.

Ultra small package, SSOT-24, SOT-25, and USP-4 are available.

APPLICATIONS

- Mobile phones (PDC, GSM, CDMA, IMT2000 etc.)
- Cordless phones,
wireless communication equipment
- Portable games
- Cameras, Video recorders
- Portable AV equipment
- PDAs

FEATURES

- Maximum Output Current** : 150mA @ $V_{OUT}=3.0V$, $V_{IN}=4.0V$
- Dropout Voltage** : 400mV @ $I_{OUT} = 100mA$
- Input Voltage Range** : 2.0 ~ 6.0V
- Output Voltage Range** : 1.2 ~ 5.0V (50mV Increments)
- Highly Accurate** : $\pm 2\%$
- Low Power Consumption** : 35 μA (TYP.)
- Stand-by Current** : Less than 0.1 μA
- High Ripple Rejection** : 60dB @ 10kHz
- Operating Temperature Range** : -40°C ~ 85°C
- Low ESR Capacitor Compatible** : Ceramic capacitor
- Ultra Small Packages** : SSOT-24
SOT-25
USP-4

TYPICAL APPLICATION CIRCUIT

- SSOT-24 package

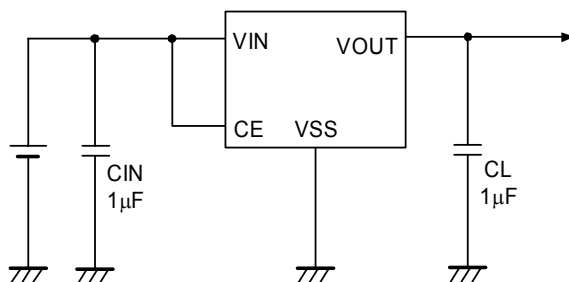

TYPICAL PERFORMANCE CHARACTERISTICS

- Ripple Rejection Rate vs. Ripple Frequency

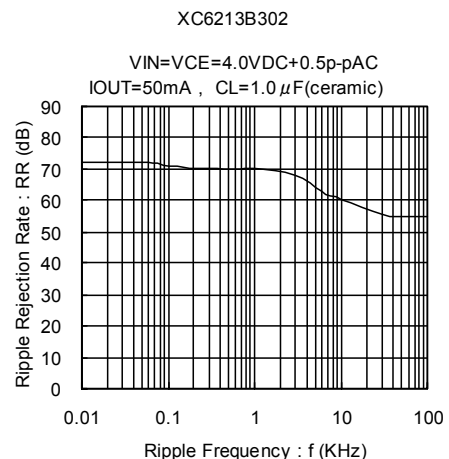

PIN CONFIGURATION

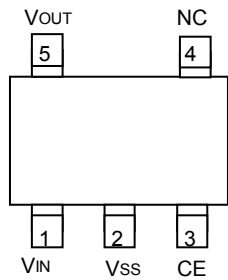

SOT-25 (SOT-23-5)
(TOP VIEW)

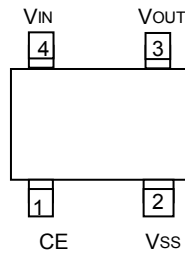

SSOT-24
(TOP VIEW)

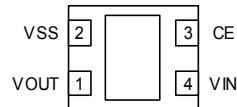

USP-4
(BOTTOM VIEW)

*The dissipation pad for the USP-4 package should be solder-plated in recommended mount pattern and metal masking so as to enhance mounting strength and heat release. If the pad needs to be connected to other pins, it should be connected to the Vss pin.

PIN ASSIGNMENT

PIN NUMBER			PIN NAME	FUNCTION
SOT-25	SSOT-24	USP-4		
3	1	3	CE	On / Off Switch
2	2	2	Vss	Ground
5	3	1	VOUT	Output
1	4	4	VIN	Power Supply
4	-	-	NC	No Connection

PRODUCT CLASSIFICATION

Ordering Information

XC6213①②③④⑤⑥

MARK	DESCRIPTION	SYMBOL	DESCRIPTION
①	Type of Regulator	B	: High Active with no pull-down resistor (standard)
②③	Output Voltage	12~50	: Output Voltage: ex.) 3.0V → ② = 3, ③ = 0
④	Output Voltage Accuracy	2	: 100mV increments, ±2% accuracy ex.) 2.80V → ②=2, ③= 8, ④= 2
		A	: 50mV increments, ±2% accuracy ex.) 2.85V → ②=2, ③= 8, ④= A
⑤	Package	M	: SOT-25 (SOT-23-5)
		N	: SSOT-24
		G	: USP-4
⑥	Device Orientation	R	: Embossed tape, standard feed
		L	: Embossed tape, reverse feed

PACKAGING INFORMATION

● SOT-25(SOT-23-5)

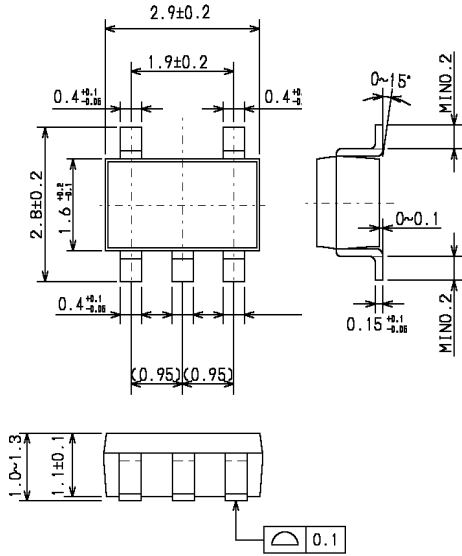

● SSOT-24

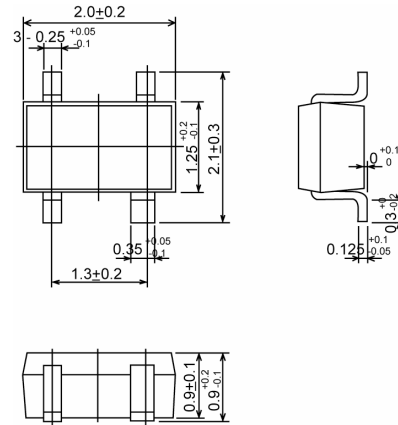

● USP-4

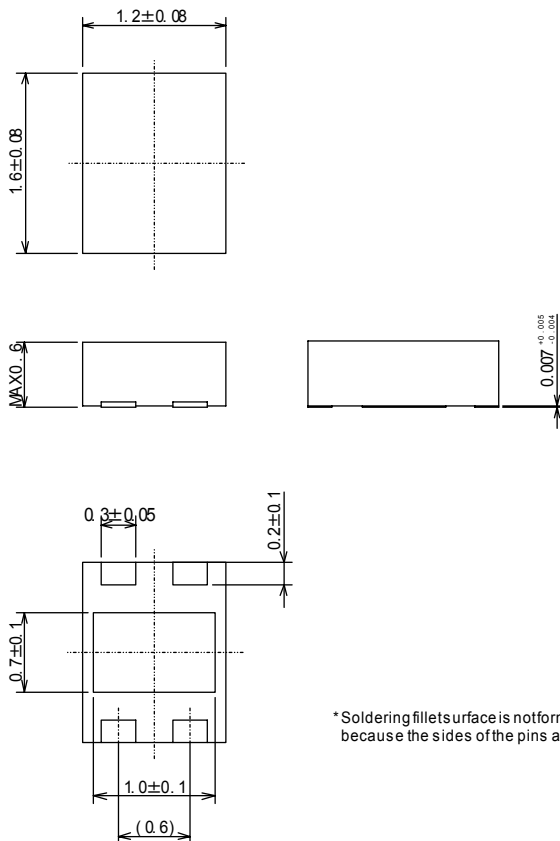

*Soldering fillets surface is not formed because the sides of the pins are plated.

XC6213 Series

MARKING RULE

●SOT-25 & USP-4

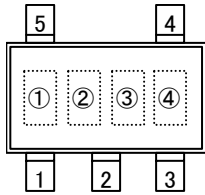

SOT-25
(TOP VIEW)

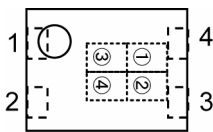

USP-4
(TOP VIEW)

①Represents product series

MARK	PRODUCT SERIES
C	XC6213xxxxxx

②③Represents type of regulator

MARK				PRODUCT SERIES
VOLTAGE =0.1~3.0V	VOLTAGE =3.1~6.0V	VOLTAGE =0.15~3.05V	VOLTAGE =3.15~6.05V	
X	B	F	M	XC6213xxxxxx

③Represents output voltage

MARK	OUTPUT VOLTAGE (V)			MARK	OUTPUT VOLTAGE (V)				
0	-	3.1	-	3.15	F	1.6	4.6	1.65	4.65
1	-	3.2	-	3.25	H	1.7	4.7	1.75	4.75
2	-	3.3	-	3.35	K	1.8	4.8	1.85	4.85
3	-	3.4	-	3.45	L	1.9	4.9	1.95	4.95
4	-	3.5	-	3.55	M	2.0	5.0	2.05	-
5	-	3.6	-	3.65	N	2.1	-	2.15	-
6	-	3.7	-	3.75	P	2.2	-	2.25	-
7	-	3.8	-	3.85	R	2.3	-	2.35	-
8	-	3.9	-	3.95	S	2.4	-	2.45	-
9	-	4.0	-	4.05	T	2.5	-	2.55	-
A	-	4.1	-	4.15	U	2.6	-	2.65	-
B	1.2	4.2	1.25	4.25	V	2.7	-	2.75	-
C	1.3	4.3	1.35	4.35	X	2.8	-	2.85	-
D	1.4	4.4	1.45	4.45	Y	2.9	-	2.95	-
E	1.5	4.5	1.55	4.55	Z	3.0	-	3.05	-

④Represents production lot number

0 to 9, to Z reverse character 0 to 9, A to Z repeated (G, I, J, O, Q, W excepted)

●SSOT-24

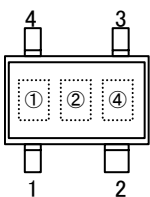

SSOT-24(SC-82)
(TOP VIEW)

①Represents integer of output voltage

MARK	VOLTAGE (V)	PRODUCT SERIES
3	3.X	XC6213B3xxNx
5	5.X	XC6213B5xxNx

②Represents decimal point of output voltage

MARK	VOLTAGE (V)	PRODUCT SERIES	MARK	VOLTAGE (V)	PRODUCT SERIES
0	X.0	XC6213Bx0xNx	A	X.05	XC6213Bx0ANx
1	X.1	XC6213Bx1xNx	B	X.15	XC6213Bx1ANx
2	X.2	XC6213Bx2xNx	C	X.25	XC6213Bx2ANx
3	X.3	XC6213Bx3xNx	D	X.35	XC6213Bx3ANx
4	X.4	XC6213Bx4xNx	E	X.45	XC6213Bx4ANx
5	X.5	XC6213Bx5xNx	F	X.55	XC6213Bx5ANx
6	X.6	XC6213Bx6xNx	H	X.65	XC6213Bx6ANx
7	X.7	XC6213Bx7xNx	K	X.75	XC6213Bx7ANx
8	X.8	XC6213Bx8xNx	L	X.85	XC6213Bx8ANx
9	X.9	XC6213Bx9xNx	M	X.95	XC6213Bx9ANx

④Represents production lot number

0 to 9, A to Z repeated (G, I, J, O, Q, W excepted). Note: No character inversion used.

■ BLOCK DIAGRAM

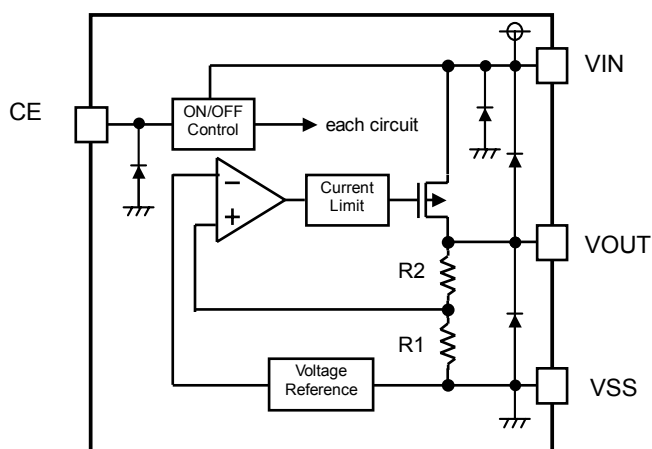

*Diode inside the circuit is a protection diode.

■ ABSOLUTE MAXIMUM RATINGS

Ta = 25°C

PARAMETER	SYMBOL	RATINGS	UNITS
Input Voltage	V _{IN}	V _{SS} - 0.3 ~ 7.0	V
Output Current	I _{OUT}	500*	mA
Output Voltage	V _{OUT}	V _{SS} - 0.3 ~ V _{IN} + 0.3	V
CE Input Voltage	V _{CE}	V _{SS} - 0.3 ~ 7.0	V
Power Dissipation	SOT-25	250	mW
	SSOT-24	150	
	USP-4	120	
Operating Temperature Range	T _{opr}	- 40 ~ + 85	°C
Storage Temperature Range	T _{stg}	- 55 ~ + 125	°C

* I_{OUT}=Pd/(V_{IN}-V_{OUT})

ELECTRICAL CHARACTERISTICS

XC6213B series

Ta=25°C

PARAMETER	SYMBOL	CONDITIONS	MIN.	TYP.	MAX.	UNITS	CIRCUITS
Output Voltage (*2)	V _{OUT(E)}	I _{OUT} =30mA, CE=V _{IN}	V _{OUT(T)} x 0.98	V _{OUT(T)}	V _{OUT(T)} x 1.02	V	①
Maximum Output Current	I _{OUTMAX}	V _{IN} =V _{OUT(T)} +1.0V, V _{OUT(T)} =1.20~1.45V, CE=V _{IN}	100	-	-	mA	①
		V _{IN} =V _{OUT(T)} +1.0V, V _{OUT(T)} =1.50~2.95V, CE=V _{IN}	120	-	-		
		V _{IN} =V _{OUT(T)} +1.0V, V _{OUT(T)} =3.00~4.05V, CE=V _{IN}	150	-	-		
		V _{IN} =V _{OUT(T)} +1.0V, V _{OUT(T)} =4.10~5.00V, CE=V _{IN}	200	-	-		
Load Regulation	ΔV _{OUT}	V _{IN} =V _{OUT(T)} +1.0V, 1mA ≤ I _{OUT} ≤ 100mA, CE=V _{IN}	-	15	50	mV	①
Dropout Voltage (*3)	V _{dif1}	I _{OUT} = 30mA, CE=V _{IN}	E-1			mV	①
	V _{dif2}	I _{OUT} =100mA, CE=V _{IN}	E-2			mV	①
Supply Current	I _{DD}	V _{IN} =V _{OUT(T)} +1.0V, CE=V _{IN}	25	35	50	μA	②
Stand-by Current	I _{stby}	V _{IN} =V _{OUT(T)} +1.0V~6.0V, CE=V _{SS}	-	0.01	0.10	μA	②
Line Regulation	$\frac{\Delta V_{OUT}}{\Delta V_{IN} \cdot V_{OUT}}$	V _{OUT(T)} +1.0V ≤ V _{IN} ≤ 6V I _{OUT} =30mA, CE=V _{IN}	-	0.01	0.20	%/V	①
Input Voltage	V _{IN}	-	2.0	-	6.0	V	-
Output Voltage Temperature Characteristics	$\frac{\Delta V_{OUT}}{\Delta T_{opr} \cdot V_{OUT}}$	I _{OUT} =30mA, CE=V _{IN} - 40°C ≤ T _{opr} ≤ 85°C	-	±100	-	ppm/ °C	①
Ripple Rejection Rate	PSRR	V _{IN} =[V _{OUT(T)} +1.0 V] +0.5V _{p-pAC} I _{OUT} =50mA, f=10kHz, CE=V _{IN}	-	60	-	dB	③
Short Circuit Current	I _{short}	V _{IN} =V _{OUT(T)} + 1.0V, CE=V _{IN}	-	50	-	mA	①
CE 'H' Level Voltage	V _{CEH}	-	1.3	-	6.0	V	①
CE 'L' Level Voltage	V _{CEL}	-	-	-	0.25	V	②
CE 'H' Level Current	I _{CEH}	V _{CE} = V _{IN} =V _{OUT(T)} + 1.0V	- 0.1	-	0.1	μA	②
CE 'L' Level Current	I _{CEL}	V _{IN} =V _{OUT(T)} + 1.0V, V _{CE} =V _{SS}	- 0.1	-	0.1	μA	②

NOTE:

- *1: V_{OUT(T)}: Setting output voltage
- *2: V_{OUT(E)} = Effective output voltage
(i.e. the output voltage when "V_{OUT(T)} + 1.0V" is provided at the V_{IN} pin while maintaining a certain I_{OUT} value).
- *3: V_{dif} = { V_{IN1} ^{(*)5} - V_{OUT1} ^{(*)4} }
- *4: V_{OUT1} = A voltage equal to 98% of the output voltage whenever an amply stabilized I_{OUT} { V_{OUT(T)} + 1.0V } is input.
- *5: V_{IN1} = The input voltage when V_{OUT1} appears as input voltage is gradually decreased.
- *6: Unless otherwise stated, (V_{IN} = V_{OUT(T)} + 1.0V).
- *7: V_{OUT(T)} ≤ 1.45V = Minimum: V_{OUT(T)}-30mV, Maximum: V_{OUT(T)}+30mV

■ ELECTRICAL CHARACTERISTICS (Continued)

● Dropout Voltage Chart

Ta=25°C

SYMBOL	E-0		E-1		E-2	
	OUTPUT VOLTAGE		DROPOUT VOLTAGE 1		DROPTOUT VOLTAGE 2	
	(V)		I _{OUT} =30mA (mV)		I _{OUT} =100mA (mV)	
	V _{OUT(T)}	V _{OUT}		V _{dif1}	V _{dif1}	V _{dif2}
MIN.		MAX.	TYP.	MAX.	TYP.	MAX.
1.20	1.170	1.230	760	800	850	1000
1.25	1.220	1.280	760	800	850	1000
1.30	1.270	1.330	660	700	810	960
1.35	1.320	1.380	660	700	810	960
1.40	1.370	1.430	560	600	770	920
1.45	1.420	1.480	560	600	770	920
1.50	1.470	1.530	460	500	730	880
1.55	1.519	1.581	460	500	730	880
1.60	1.568	1.632	360	400	690	840
1.65	1.617	1.683	360	400	690	840
1.70	1.666	1.734	260	300	650	800
1.75	1.715	1.785	260	300	650	800
1.80	1.764	1.836	200	240	600	750
1.85	1.813	1.887	200	240	600	750
1.90	1.862	1.938	200	240	600	750
1.95	1.911	1.989	200	240	600	750
2.00	1.960	2.040	190	230	530	670
2.05	2.009	2.091	190	230	530	670
2.10	2.058	2.142	190	230	530	670
2.15	2.107	2.193	190	230	530	670
2.20	2.156	2.244	190	230	530	670
2.25	2.205	2.295	190	230	530	670
2.30	2.254	2.346	190	230	530	670
2.35	2.303	2.397	190	230	530	670
2.40	2.352	2.448	190	230	530	670
2.45	2.401	2.499	190	230	530	670
2.50	2.450	2.550	180	210	470	580
2.55	2.499	2.601	180	210	470	580
2.60	2.548	2.652	180	210	470	580
2.65	2.597	2.703	180	210	470	580
2.70	2.646	2.754	180	210	470	580
2.75	2.695	2.805	180	210	470	580
2.80	2.744	2.856	180	210	470	580
2.85	2.793	2.907	180	210	470	580
2.90	2.842	2.958	180	210	470	580
2.95	2.891	3.009	180	210	470	580
3.00	2.940	3.060	150	180	400	500
3.05	2.989	3.111	150	180	400	500
3.10	3.038	3.162	150	180	400	500
3.15	3.087	3.213	150	180	400	500
3.20	3.136	3.264	150	180	400	500
3.25	3.185	3.315	150	180	400	500
3.30	3.234	3.366	150	180	400	500
3.35	2.283	3.417	150	180	400	500
3.40	2.332	3.468	150	180	400	500
3.45	3.381	3.519	150	180	400	500

■ ELECTRICAL CHARACTERISTICS (Continued)

● Dropout Voltage Chart (Continued)

Ta=25°C

SYMBOL	E-0		E-1		E-2	
	OUTPUT VOLTAGE (V)		DROPOUT VOLTAGE 1		DROPTOUT VOLTAGE 2	
			I _{OUT} =30mA (mV)		I _{OUT} =100mA (mV)	
V _{OUT(T)}	V _{OUT}		V _{dif1}	V _{dif1}	V _{dif2}	V _{dif2}
	MIN.	MAX.	TYP.	MAX.	TYP.	MAX.
3.50	3.430	3.570	140	170	350	450
3.55	3.479	3.621	140	170	350	450
3.60	3.528	3.672	140	170	350	450
3.65	3.577	3.723	140	170	350	450
3.70	3.626	3.774	140	170	350	450
3.75	3.675	3.825	140	170	350	450
3.80	3.724	3.876	140	170	350	450
3.85	3.773	3.927	140	170	350	450
3.90	3.822	3.978	140	170	350	450
3.95	3.871	4.029	140	170	350	450
4.00	3.920	4.080	130	160	320	420
4.05	3.969	4.131	130	160	320	420
4.10	4.018	4.182	130	160	320	420
4.15	4.067	4.233	130	160	320	420
4.20	4.116	4.284	130	160	320	420
4.25	4.165	4.335	130	160	320	420
4.30	4.214	4.386	130	160	320	420
3.35	4.263	4.437	130	160	320	420
4.40	4.312	4.488	130	160	320	420
4.45	4.361	4.539	130	160	320	420
4.50	4.410	4.590	120	150	300	400
4.55	4.459	4.641	120	150	300	400
4.60	4.508	4.692	120	150	300	400
4.65	4.557	4.743	120	150	300	400
4.70	4.606	4.794	120	150	300	400
4.75	4.655	4.845	120	150	300	400
4.80	4.704	4.896	120	150	300	400
4.85	4.753	4.947	120	150	300	400
7.90	4.802	4.998	120	150	300	400
4.95	4.851	5.049	120	150	300	400
5.00	4.900	5.100	120	150	300	400

TEST CIRCUITS

● Circuit ①

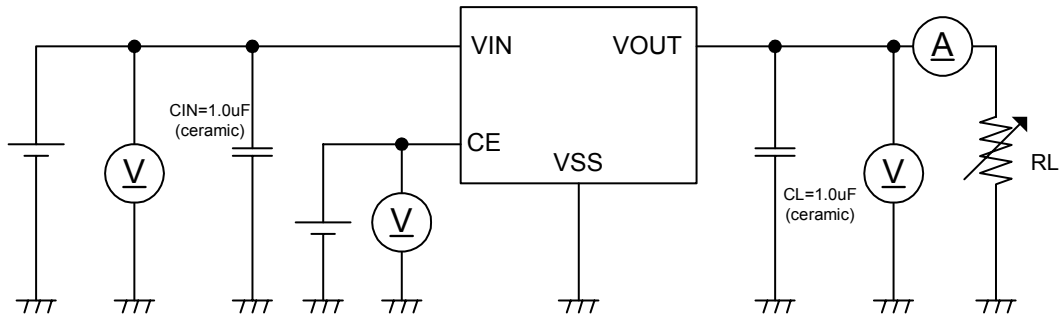

● Circuit ②

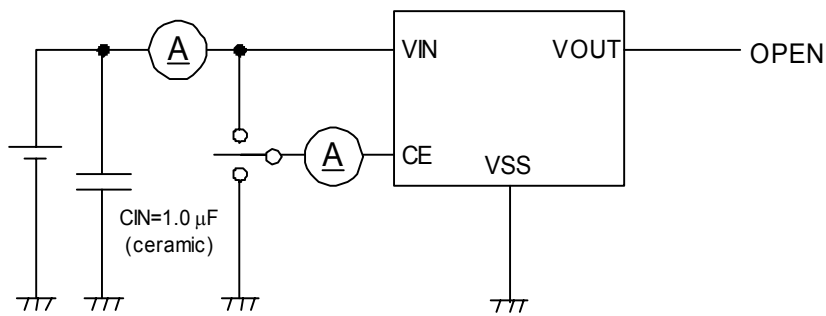

● Circuit ③

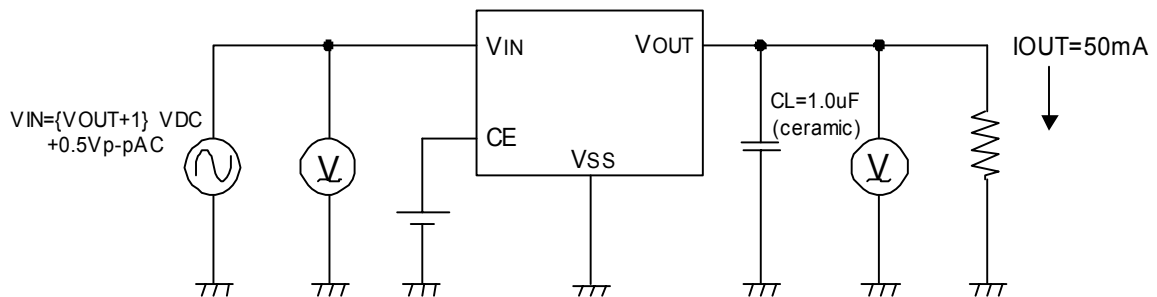

OPERATIONAL EXPLANATION

<Output Voltage Regulator Control>

The voltage, divided by resistors R1 & R2, which are connected to the VOUT pin is compared with the internal reference voltage by the error amplifier. The P-channel MOSFET, which is connected to the VOUT pin, is then driven by the subsequent output signal. The output voltage at the VOUT pin is controlled & stabilized by negative feedback. The current limit circuit and short circuit protection operate in relation to the level of output current. Further, the voltage regulator's internal circuitry can be shutdown via the CE pin's signal.

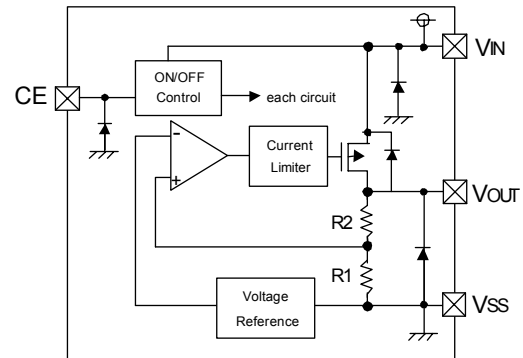

<Low ESR Capacitor>

With the XC6213 series regulator, a stable output voltage is achievable even if low ESR capacitors are used, as a phase compensation circuit is built-in to the regulator. In order to ensure the effectiveness of the phase compensation, please connect an output capacitor (CL) with a capacitance, based on the chart below. The equivalent serial resistor (ESR) of the output capacitor (CL) should be within the range as the graph below shown. We also suggest an input capacitor (CIN) of 1.0 μ F: this should be connected between VIN and VSS in order to stabilize input power source.

Output Capacitor Corresponding Chart

SETTING VOLTAGE	1.2 ~ 1.75V	1.8 ~ 5.0V
CL	More than 3.3 μ F	More than 1.0 μ F

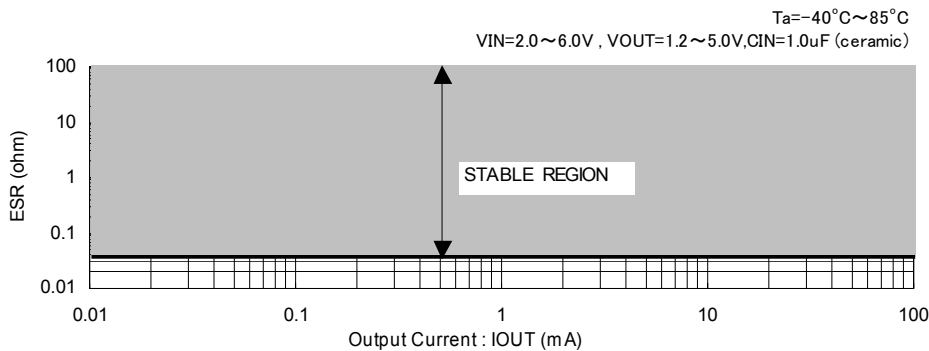

<Short-Circuit Protection>

The XC6213 series regulator offers circuit protection by means of a built-in foldback circuit. When the load current reaches the current limit level, the fixed current limiter circuit operates and output voltage drops. As a result of this drop in output voltage, the foldback circuit operates, the output voltage drops further and output current decreases. When the output pin is shorted, a current of about 50mA flows.

<CE Pin>

The IC's internal regulator circuitry can be shut down via the signal from the CE pin with the XC6213 series. In shutdown mode, output at the VOUT pin will be pulled down to the VSS level. Note that as the XC6213B types are 'High Active / No Pull-Down', operations will become unstable with the CE pin open. We suggest that you use this IC with either a VIN voltage or a VSS voltage input at the CE pin. If this IC is used with the correct specifications for the CE pin, the IC will operate normally. However, supply current may increase as a result of through current in the IC's internal circuitry if a voltage other than VIN or VSS is applied.

<Minimum Operating Voltage>

Please apply input voltage more than 2.0V or more in order to stabilize the operation of the IC's. Normal output voltage may not be obtained when the input voltage is lower than 2.0V.

NOTES ON USE

1. Please use this IC within the stated absolute maximum ratings. The IC is liable to malfunction should the ratings be exceeded.
2. Where wiring impedance is high, operations may become unstable due to noise and/or phase lag depending on output current. Please strengthen VIN and VSS wiring in particular.
3. Please wire the input capacitor (CIN) and the output capacitor (CL) as close to the IC as possible. Should rapid input fluctuation or load fluctuation occur, please increase the capacitor value such as CIN or CL to stabilize the operation.
4. Make sure not to use the IC with large current at high temperature. When exceeding power dissipation of a package, heat occurs before short protection operates, and the IC may break.

■ TYPICAL PERFORMANCE CHARACTERISTICS

(1) Output Voltage vs. Output Current

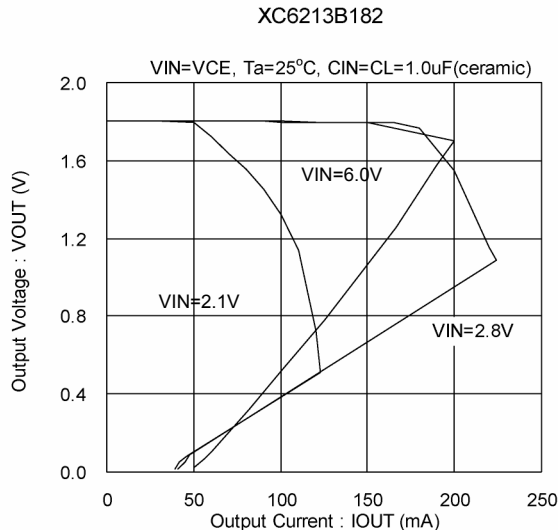
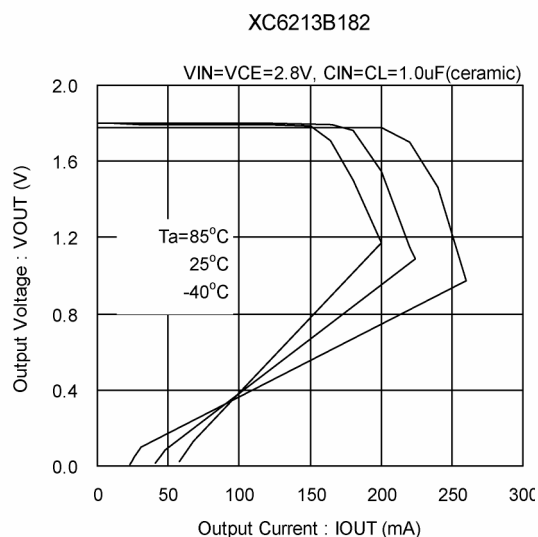
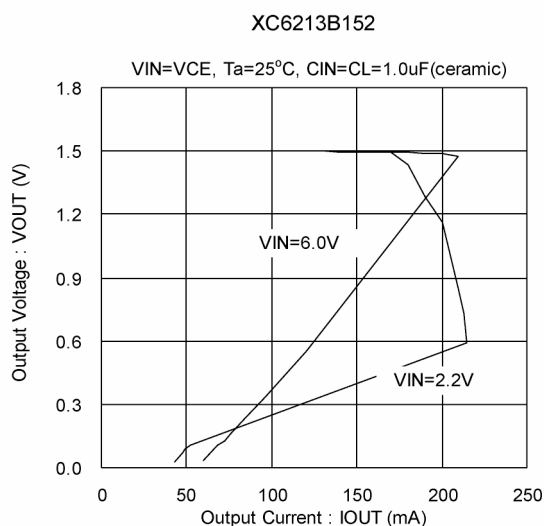
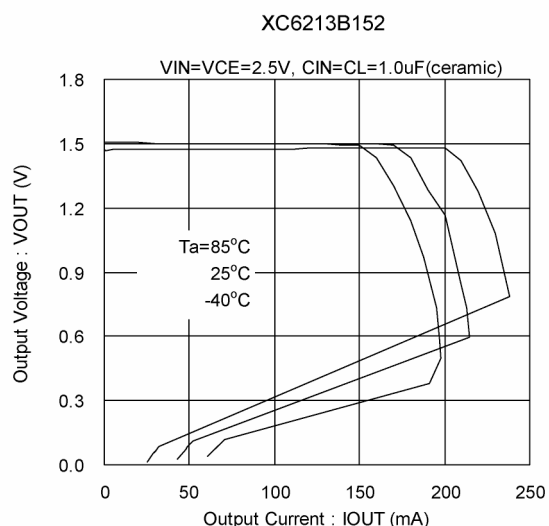
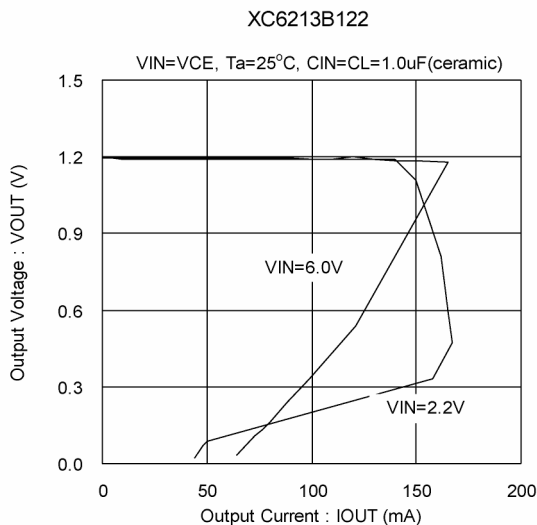
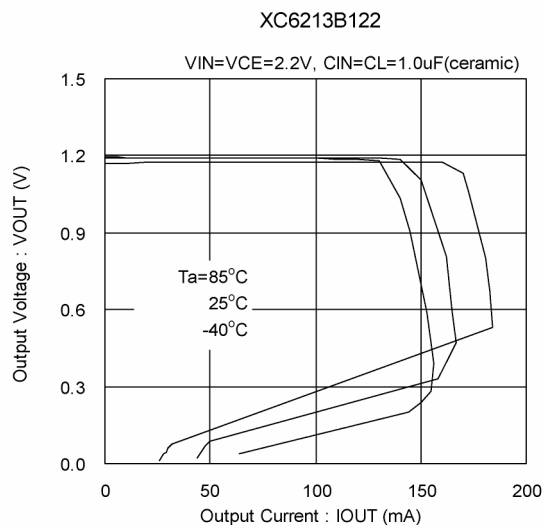

■ TYPICAL PERFORMANCE CHARACTERISTICS (Continued)

(1) Output Voltage vs. Output Current (Continued)

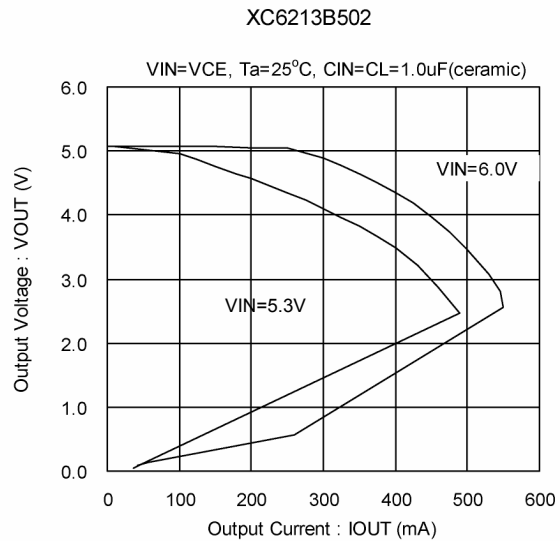
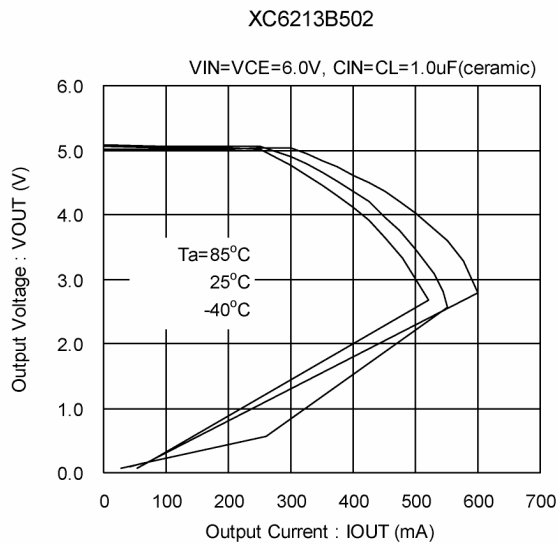
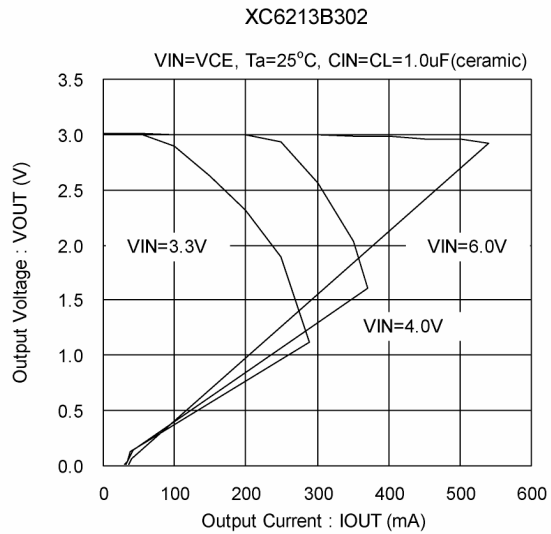
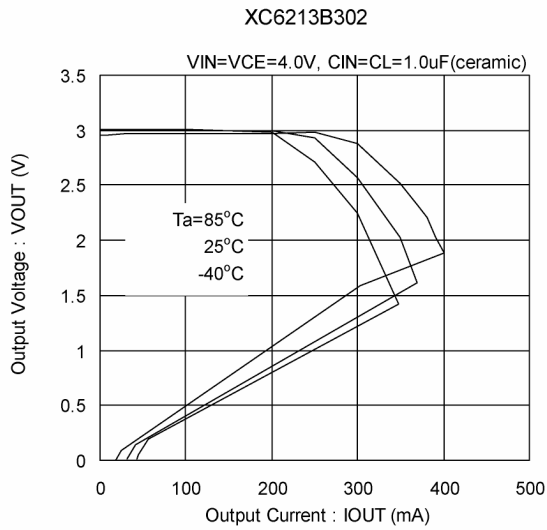

■ TYPICAL PERFORMANCE CHARACTERISTICS (Continued)

(2) Output Voltage vs. Input Voltage

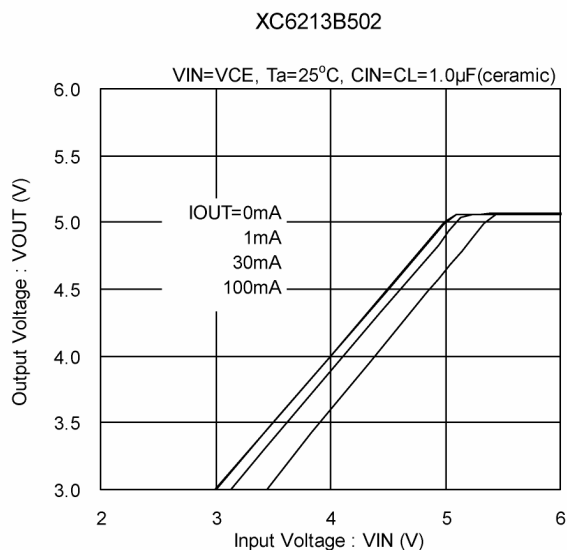
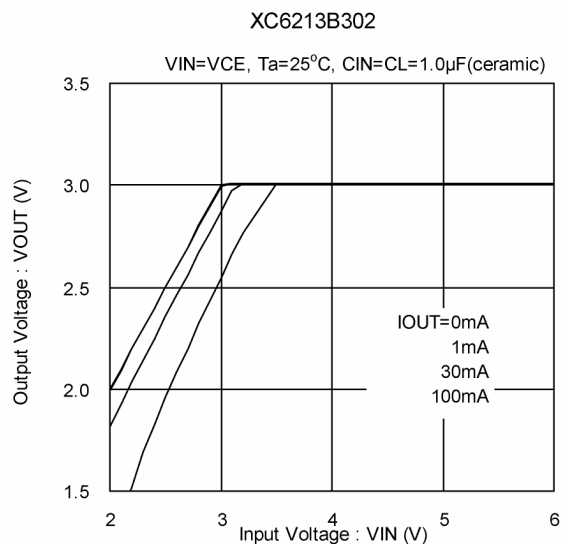
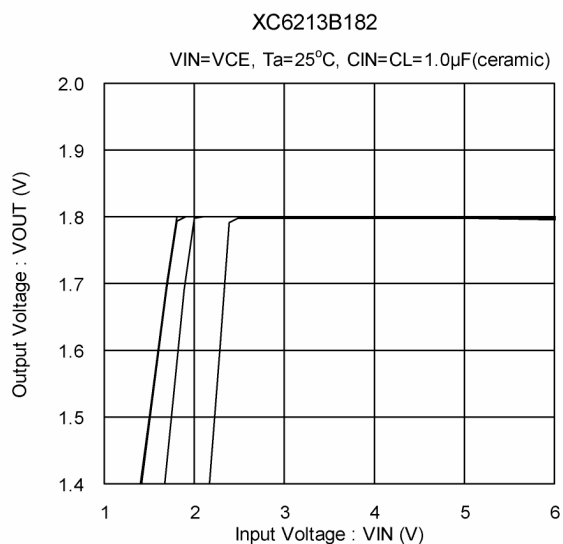
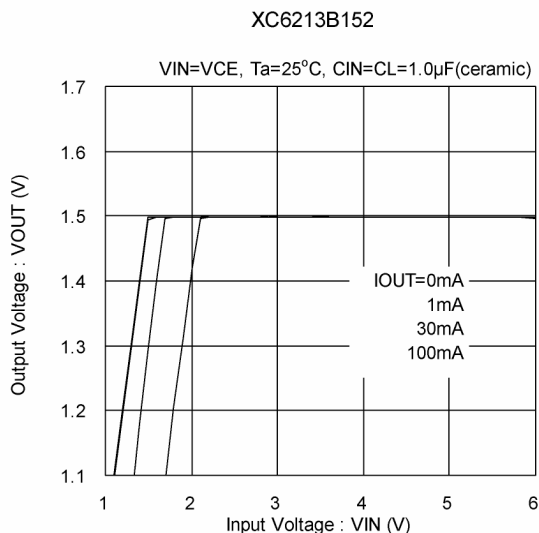
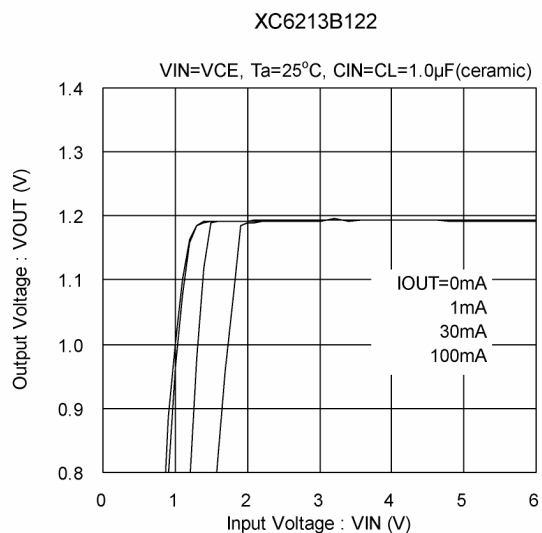

■ TYPICAL PERFORMANCE CHARACTERISTICS (Continued)

(3) Dropout Voltage vs. Output Current

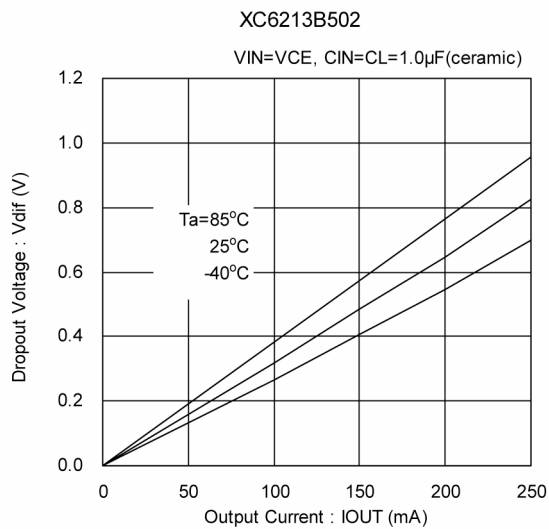
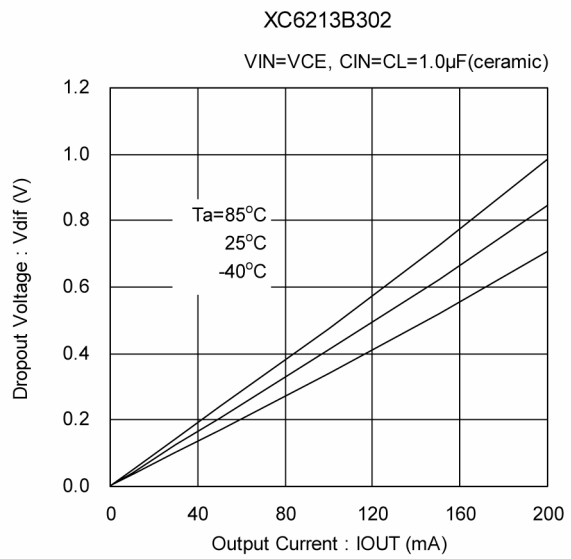
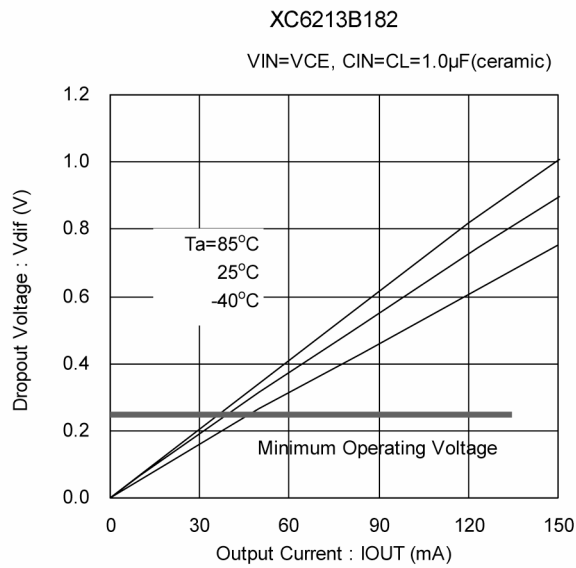
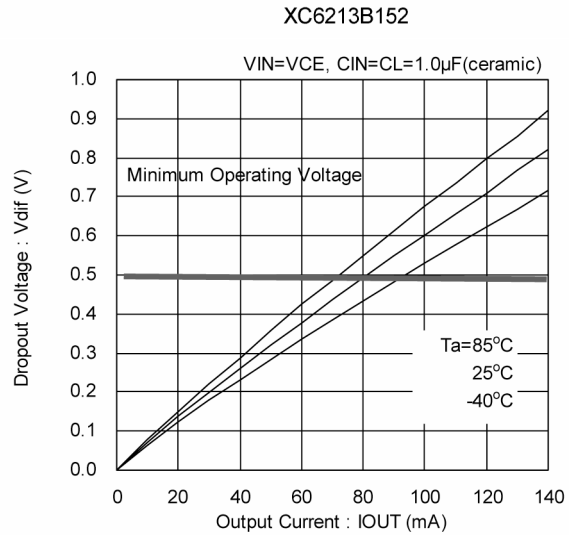
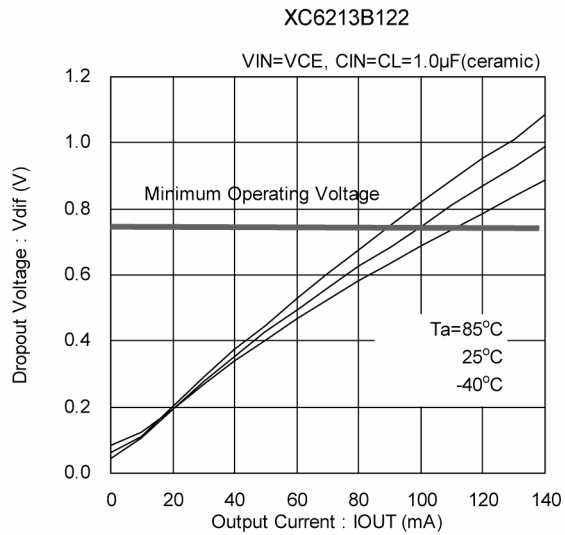

■ TYPICAL PERFORMANCE CHARACTERISTICS (Continued)

(4) Supply Current vs. Input Voltage

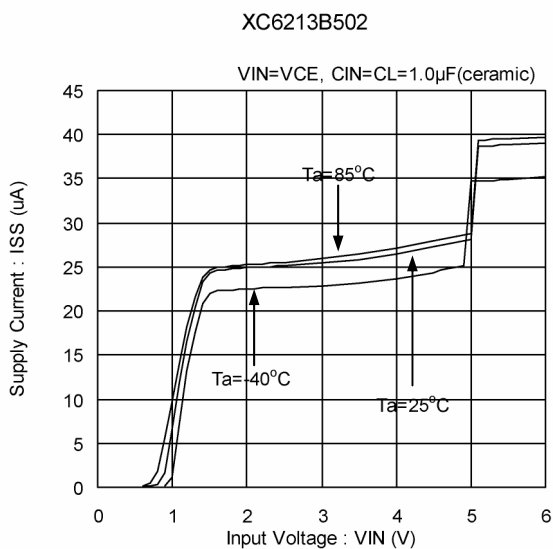
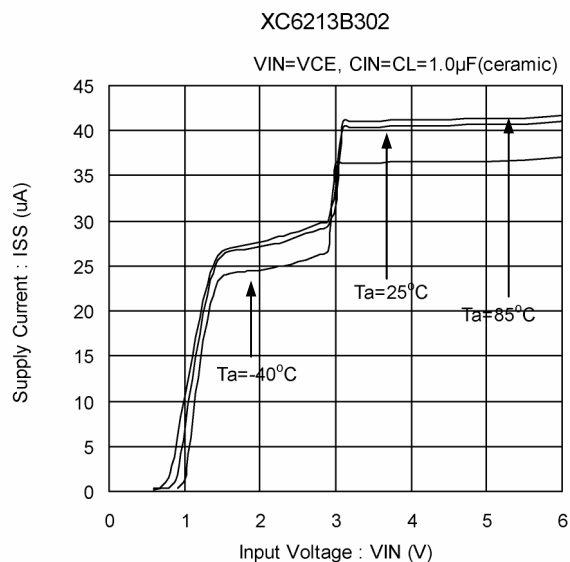
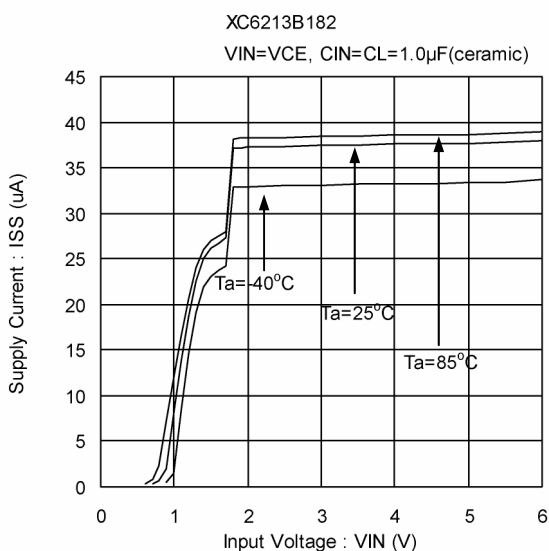
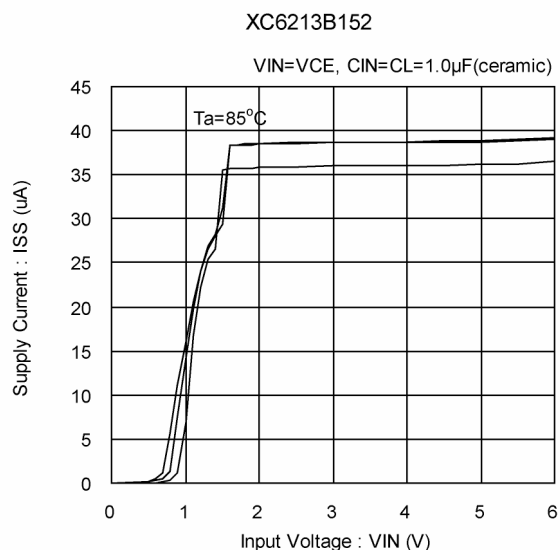
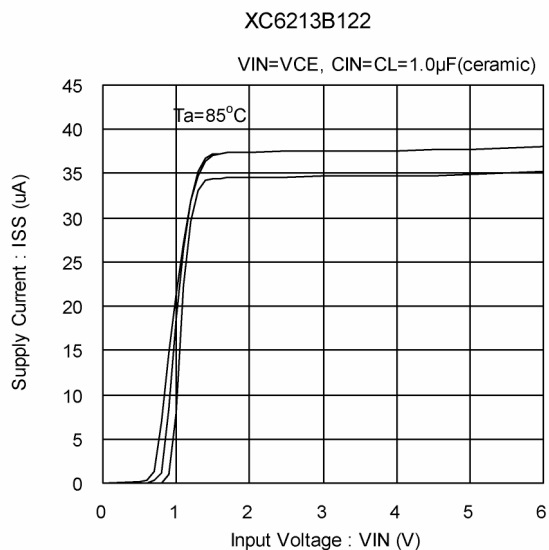

■ TYPICAL PERFORMANCE CHARACTERISTICS (Continued)

(5) Output Voltage vs. Ambient Temperature

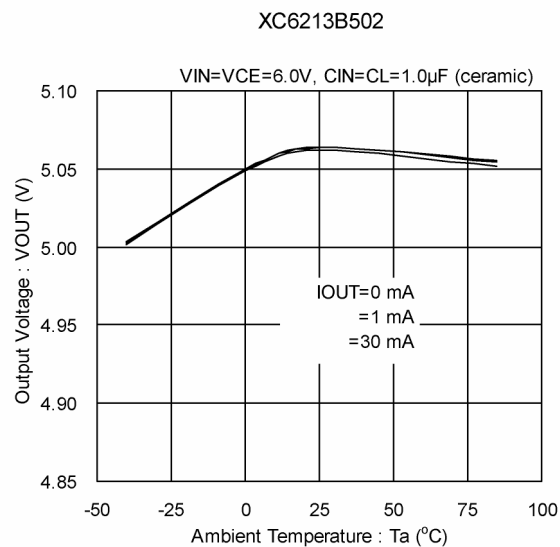
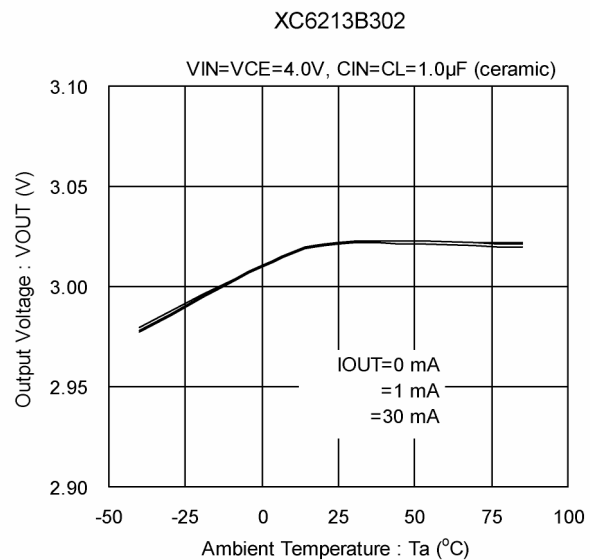
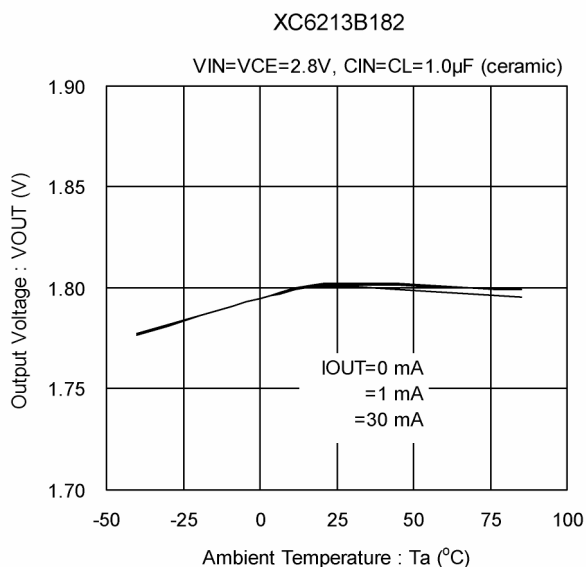
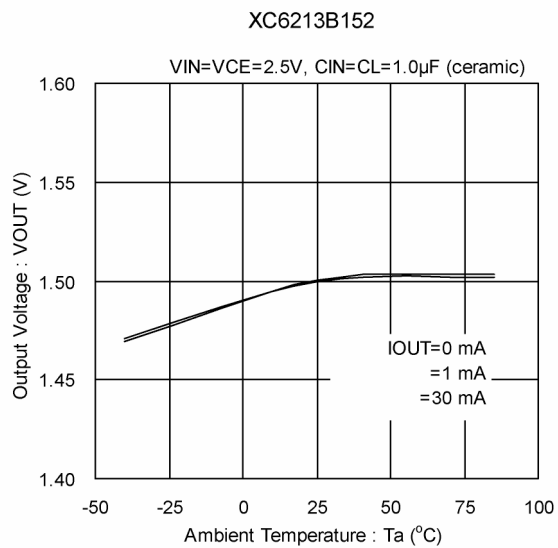
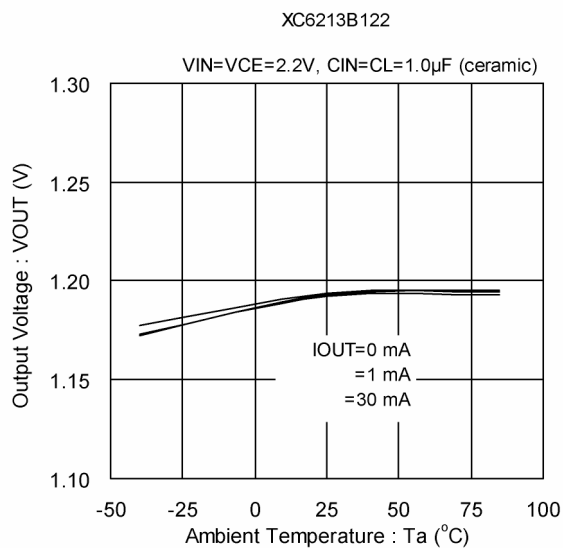

■ TYPICAL PERFORMANCE CHARACTERISTICS (Continued)

(6) Supply Current vs. Ambient Temperature

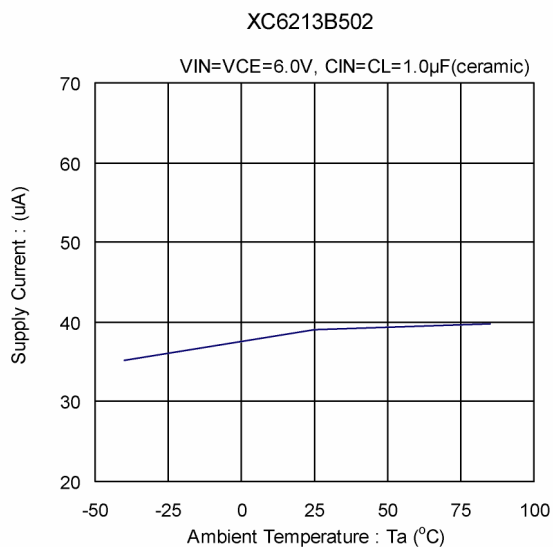
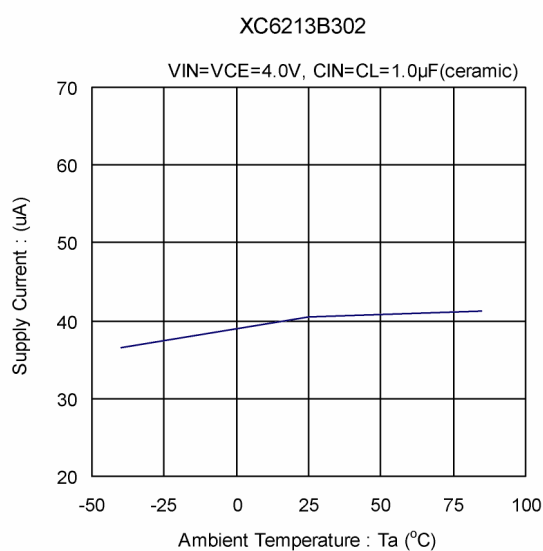
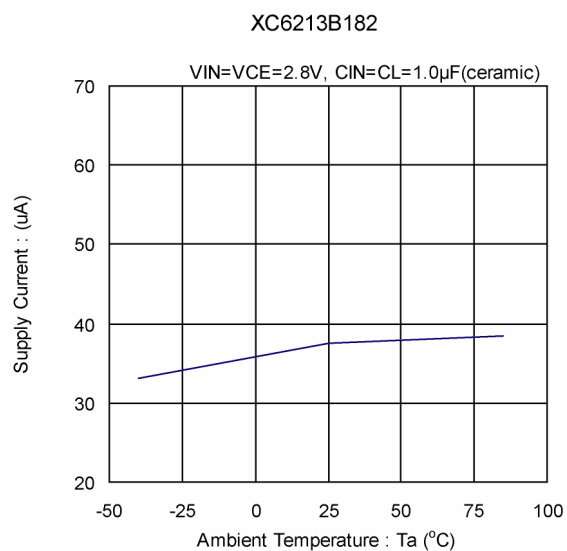
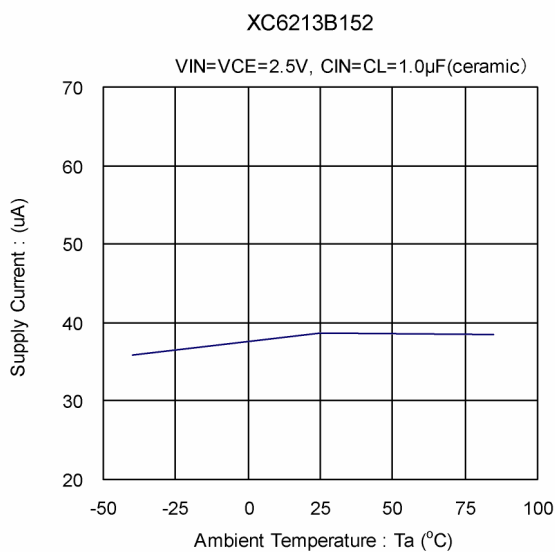
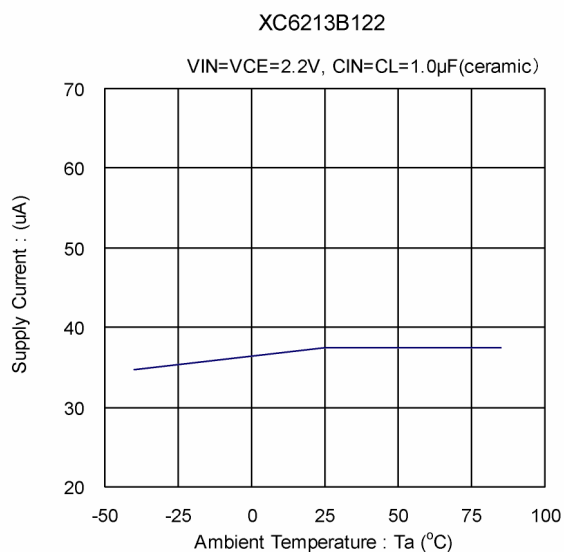

(7) CE Threshold Voltage vs. Ambient Temperature

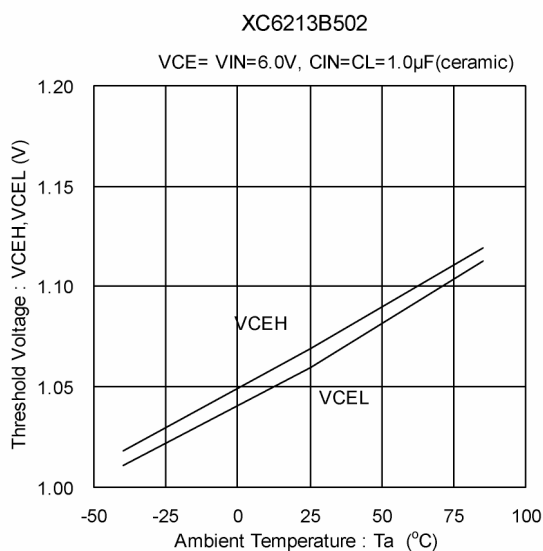

■ TYPICAL PERFORMANCE CHARACTERISTICS (Continued)

(8) Input Transient Response

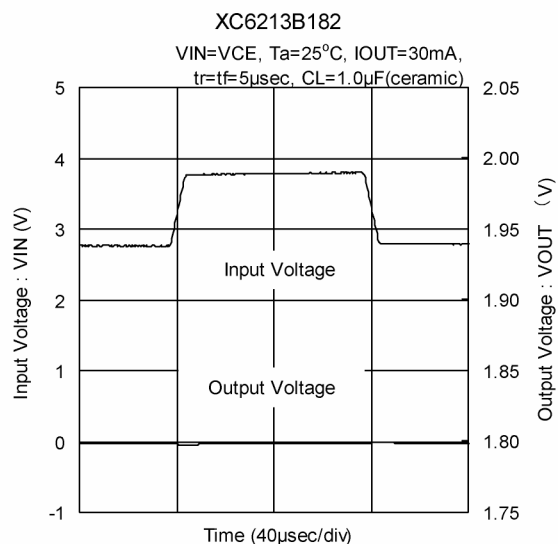
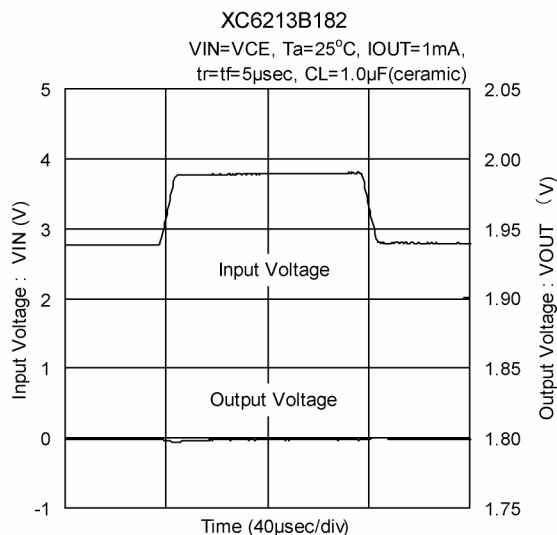
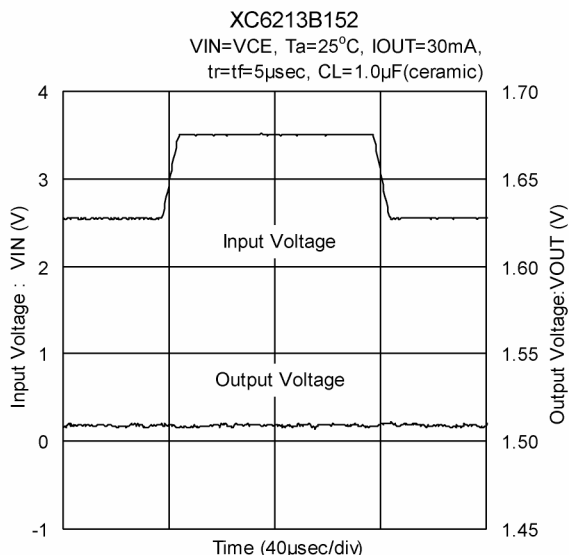
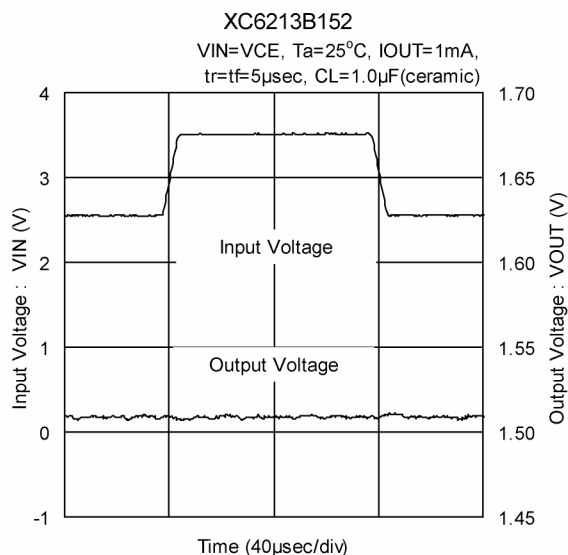
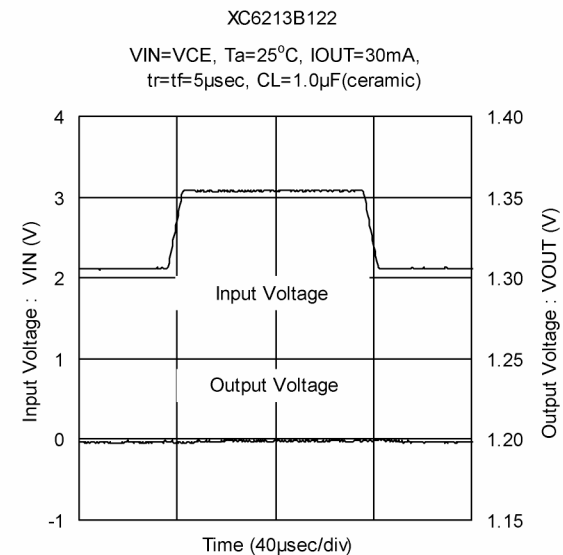
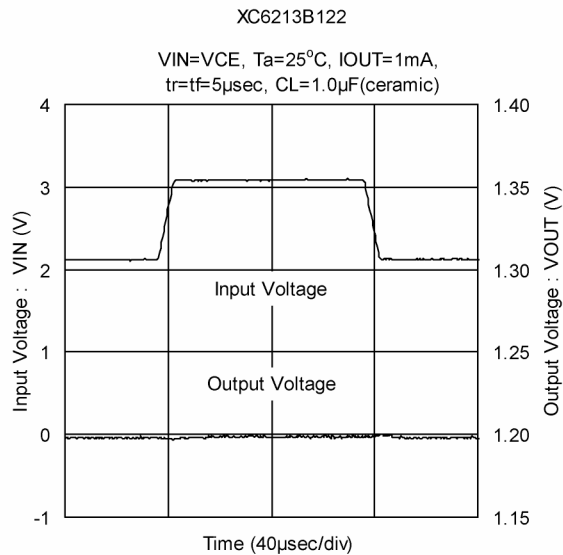

■ TYPICAL PERFORMANCE CHARACTERISTICS (Continued)

(8) Input Transient Response (continued)

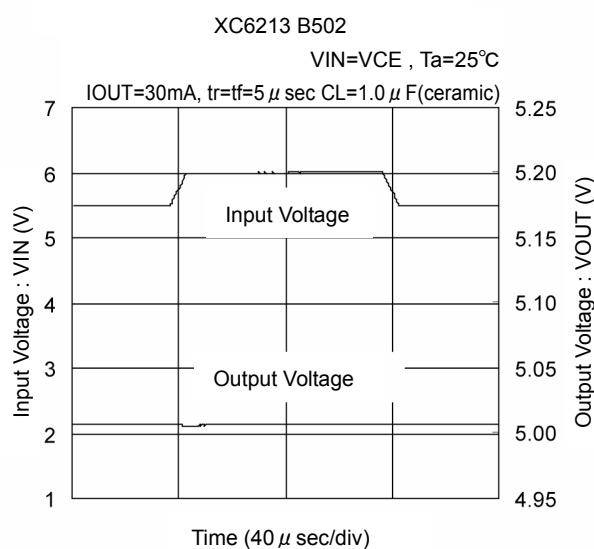
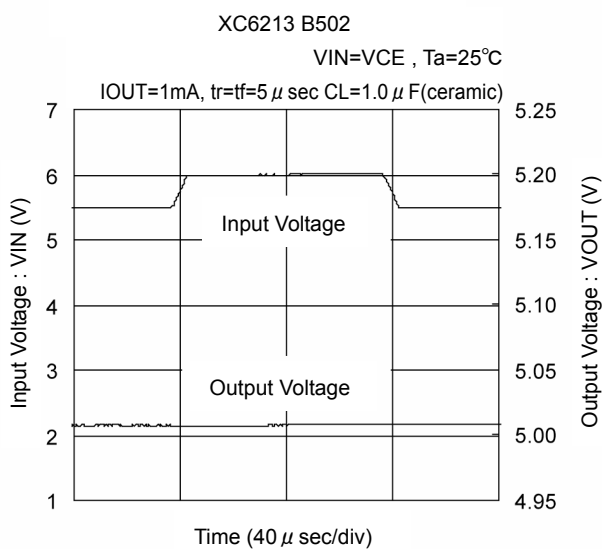
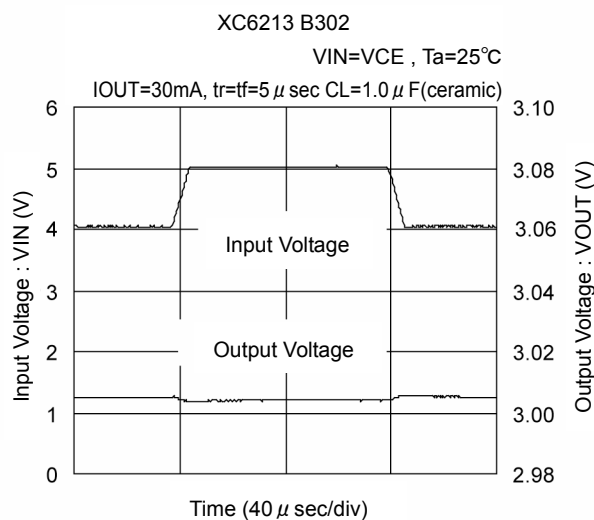
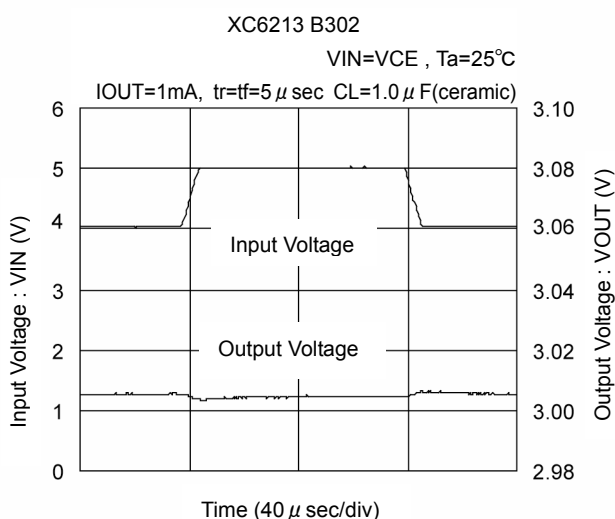

■ TYPICAL PERFORMANCE CHARACTERISTICS (Continued)

(9) Load Transient Response

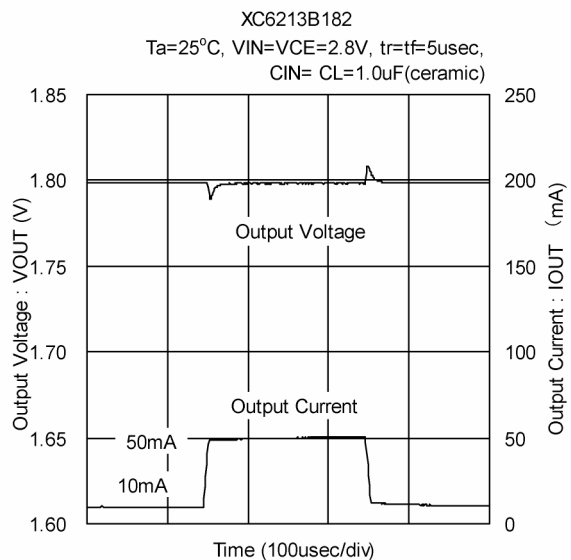
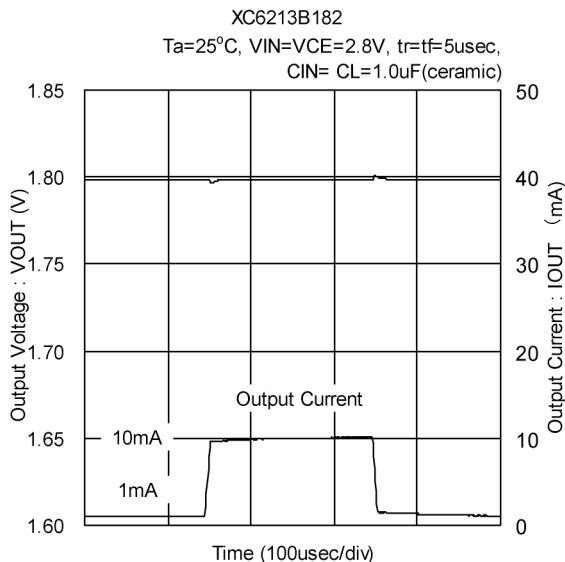
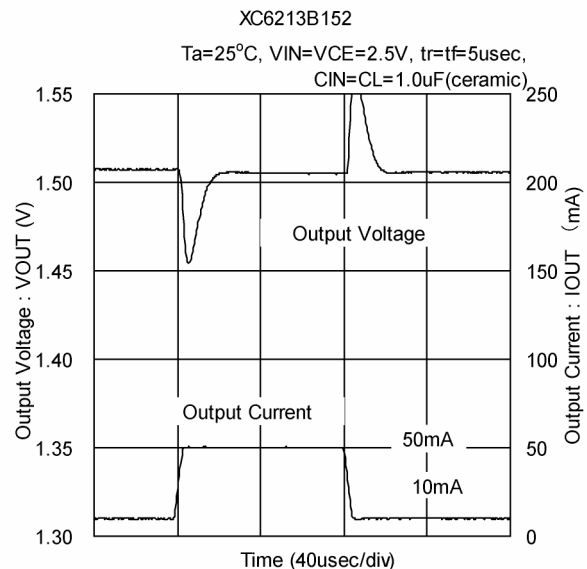
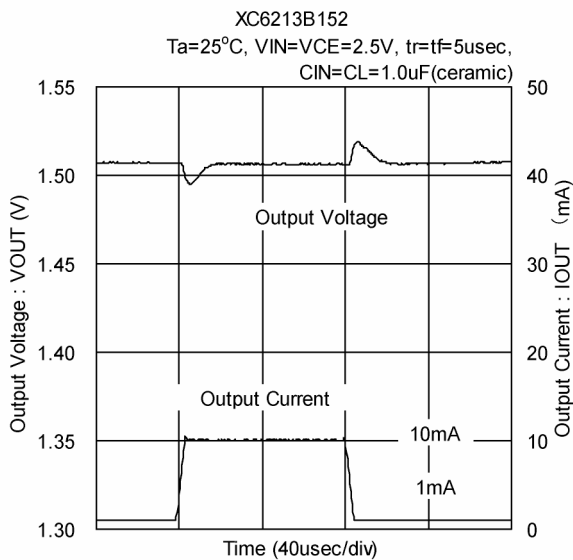
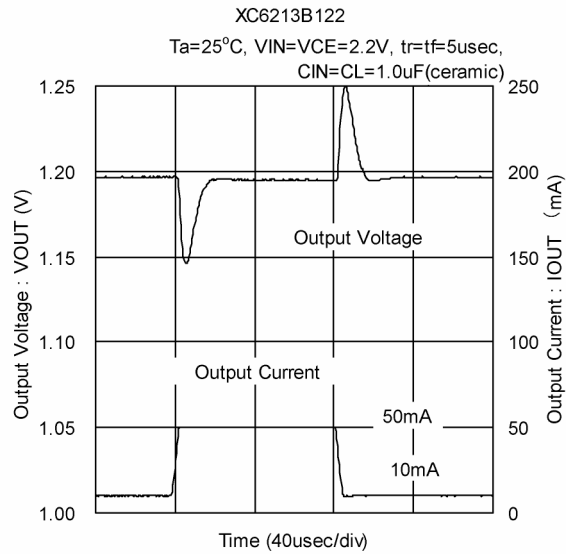
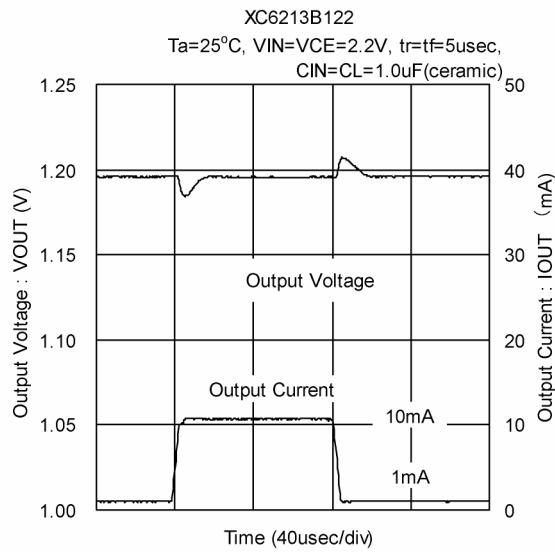

■ TYPICAL PERFORMANCE CHARACTERISTICS (Continued)

(9) Load Transient Response (Continued)

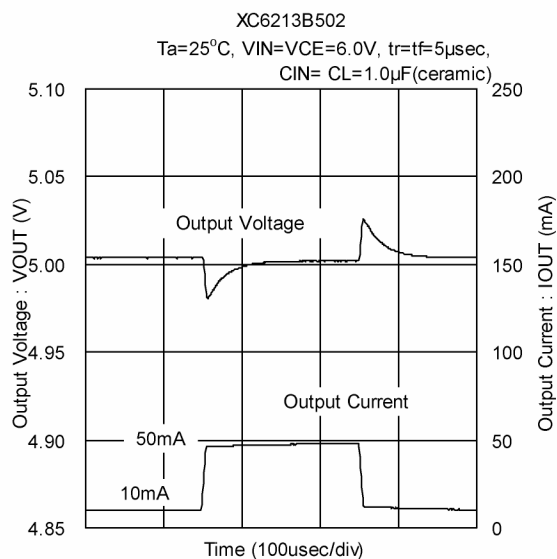
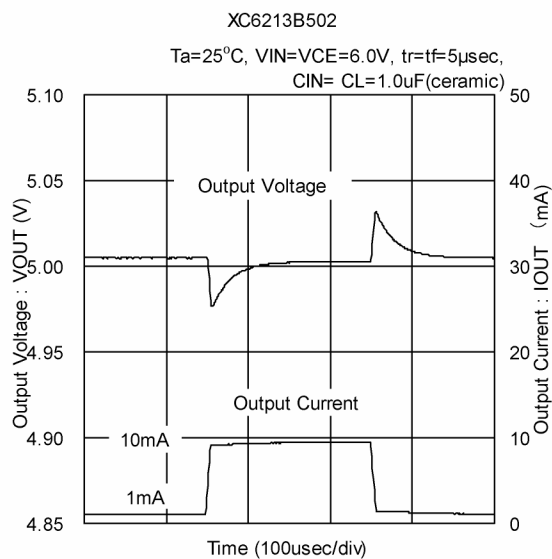
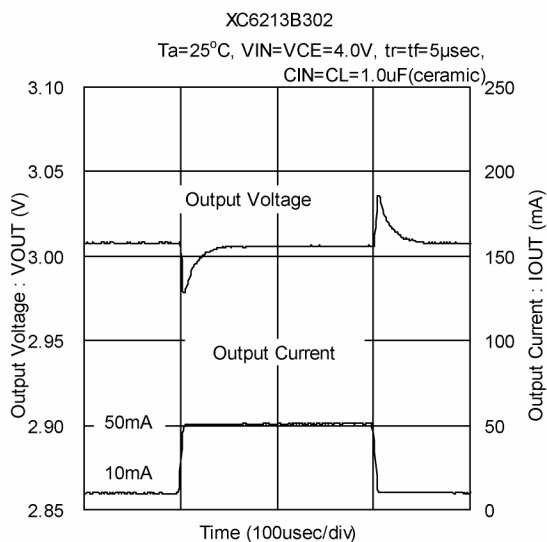
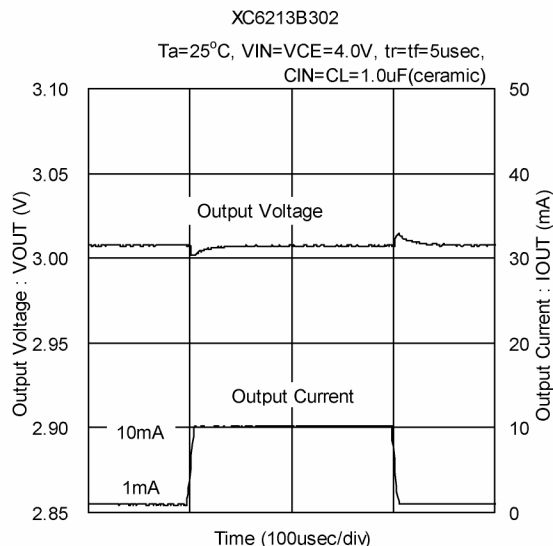

■ TYPICAL PERFORMANCE CHARACTERISTICS (Continued)

(10) Turn-On Response

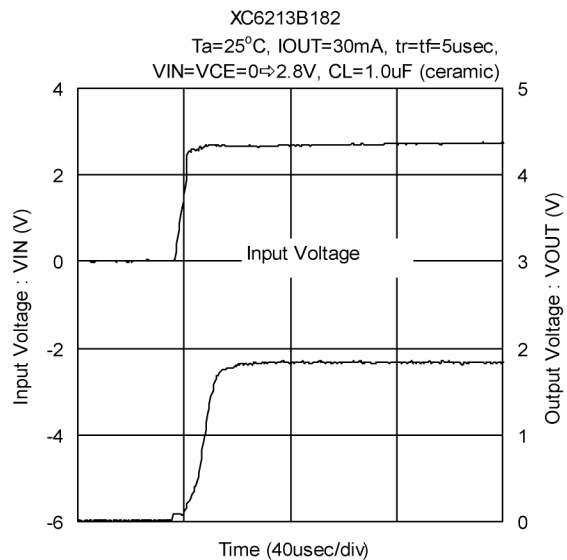
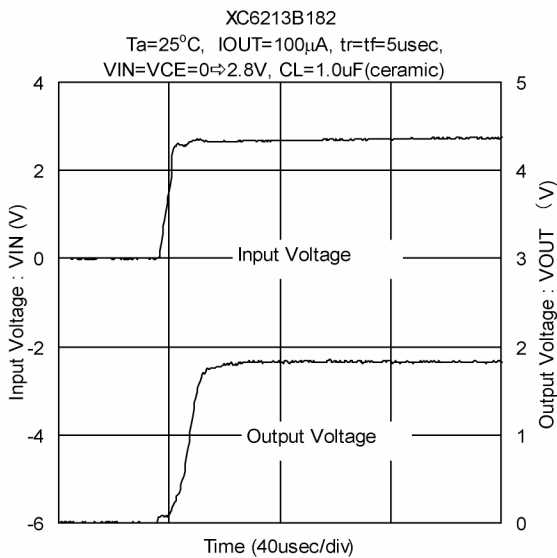
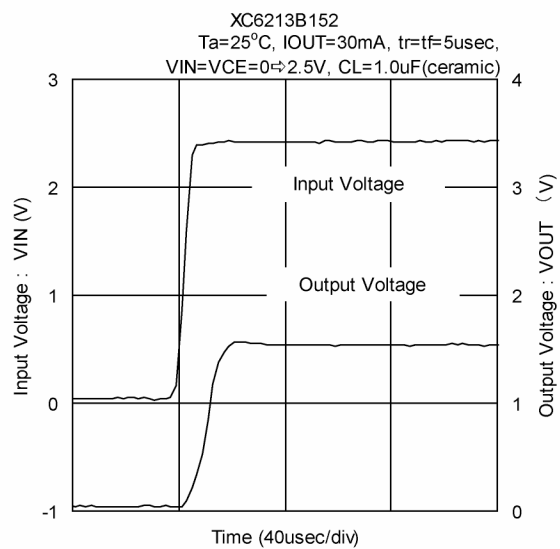
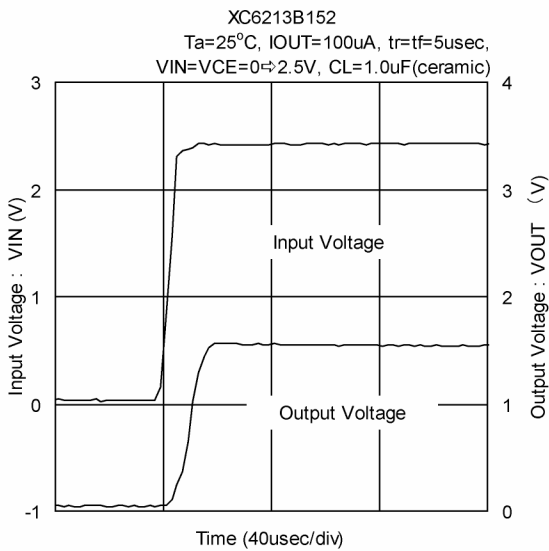
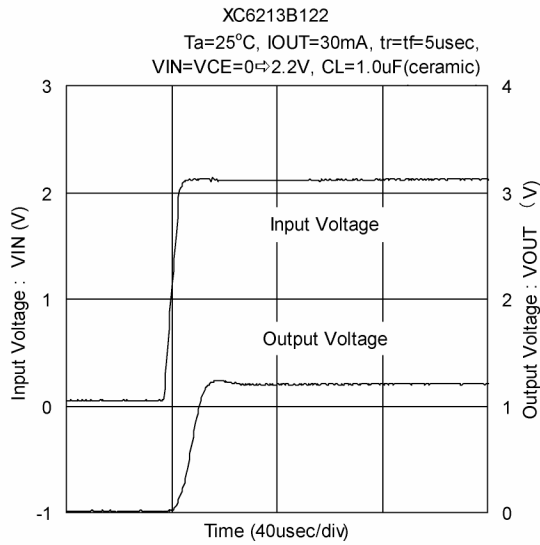
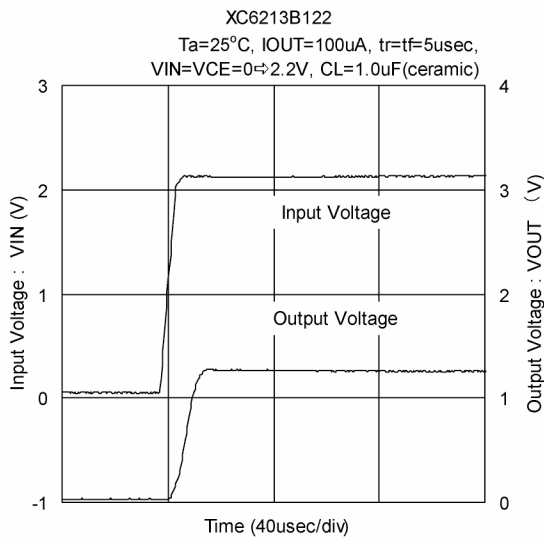

■ TYPICAL PERFORMANCE CHARACTERISTICS (Continued)

(10) Turn-On Response (Continued)

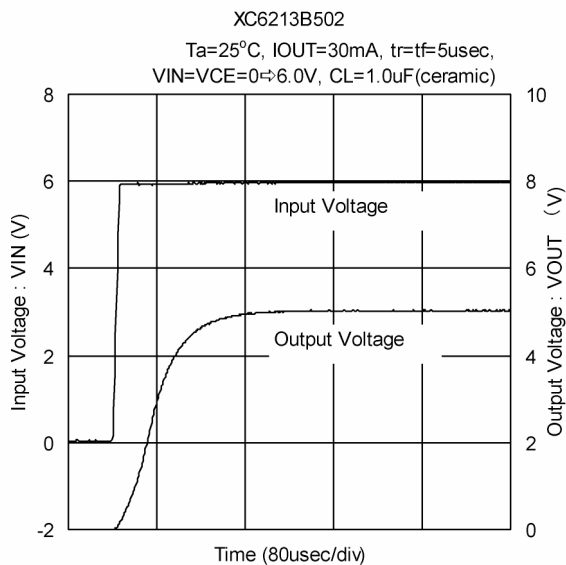
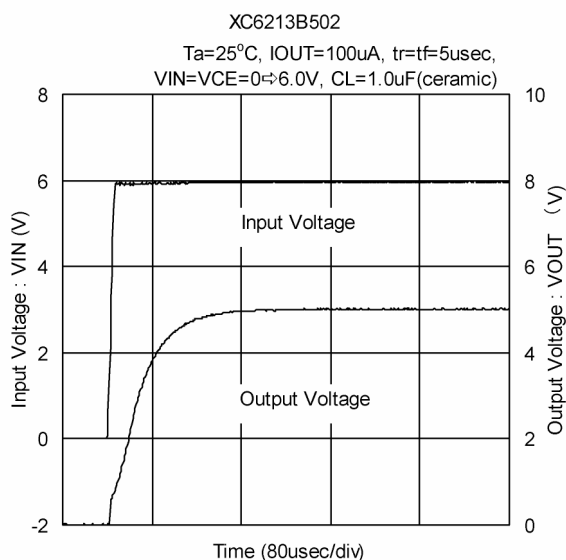
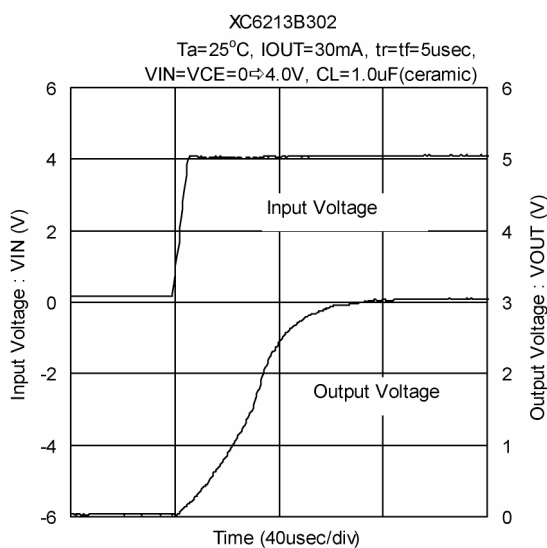
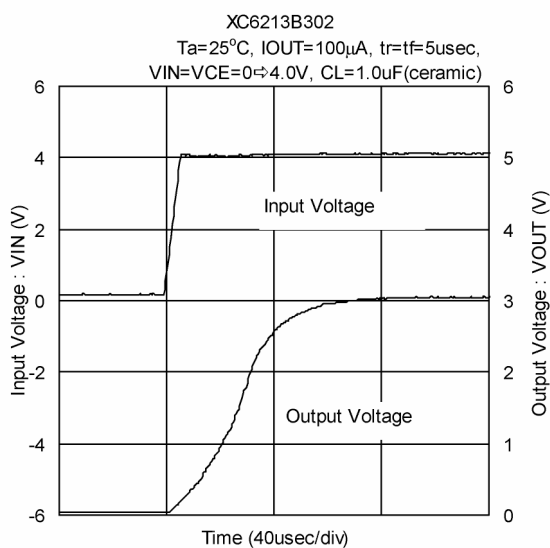

■ TYPICAL PERFORMANCE CHARACTERISTICS (Continued)

(11) Enable Response

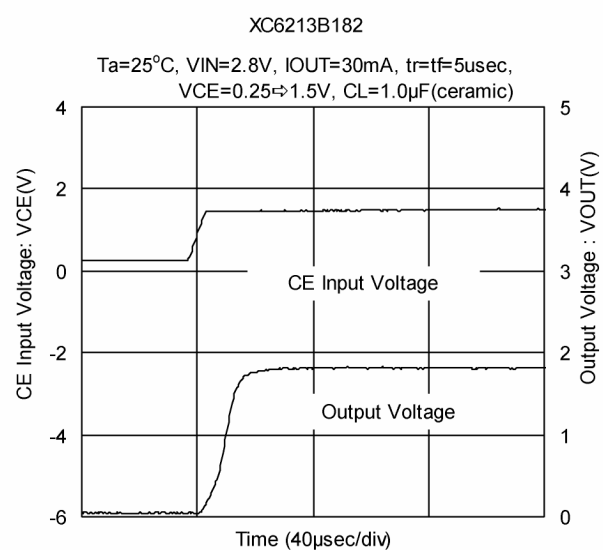
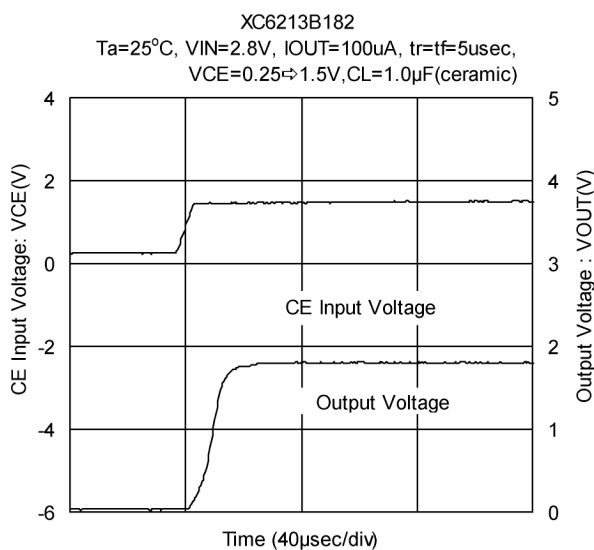
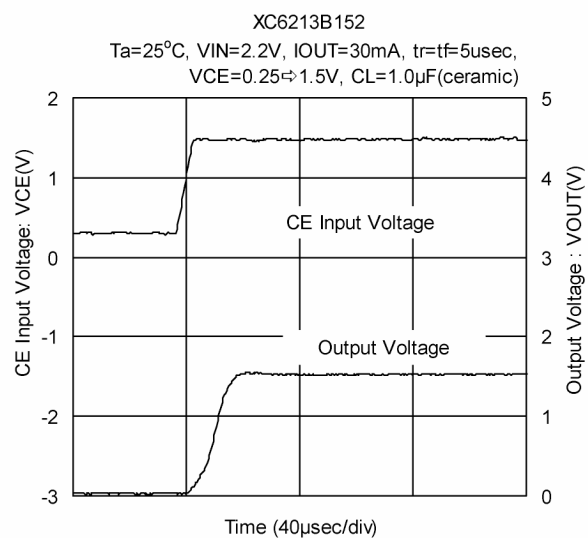
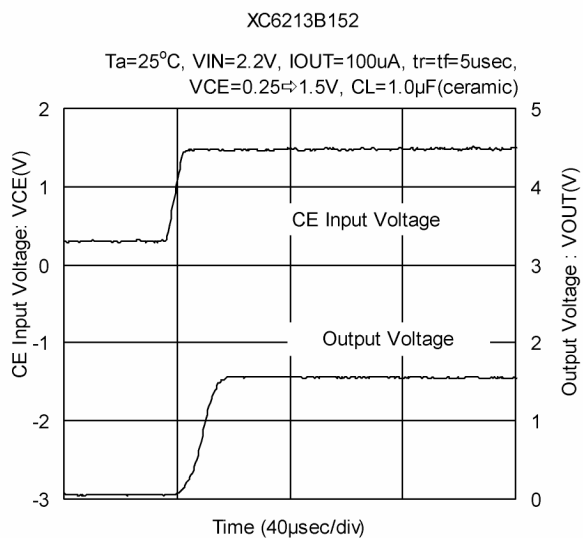
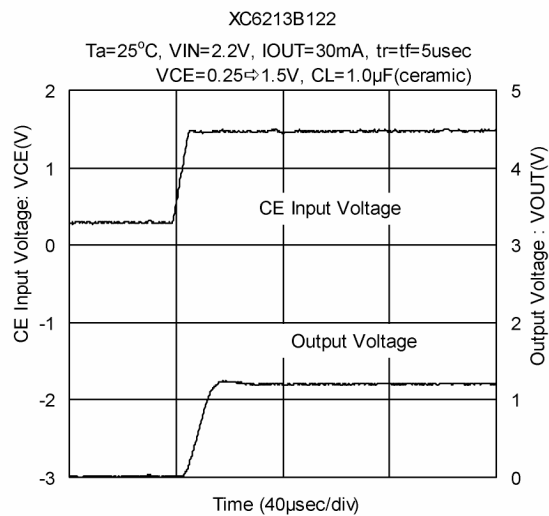
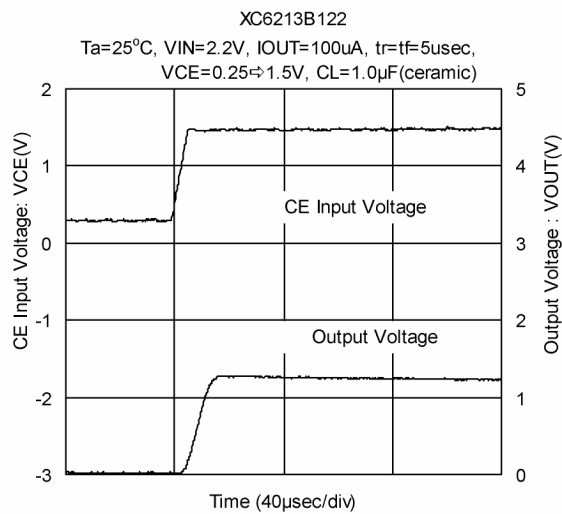

■ TYPICAL PERFORMANCE CHARACTERISTICS (Continued)

(11) Enable Response (Continued)

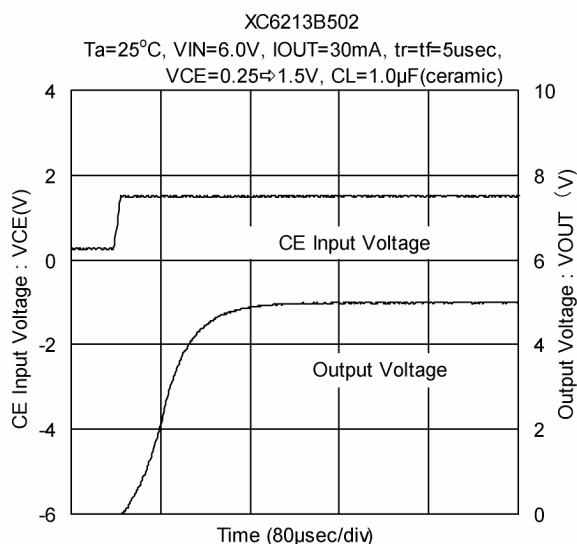
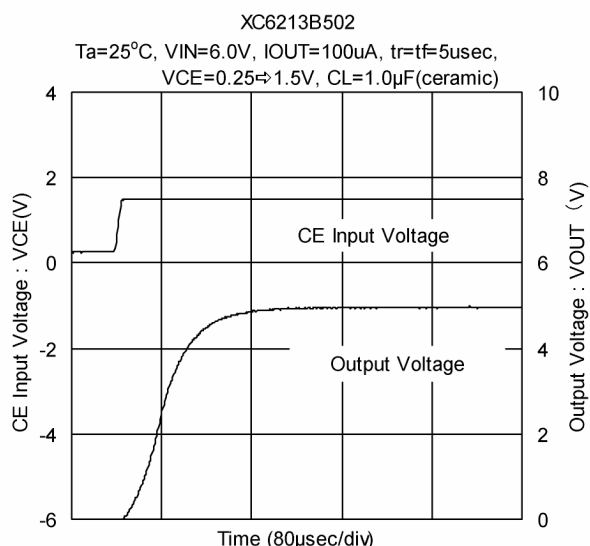
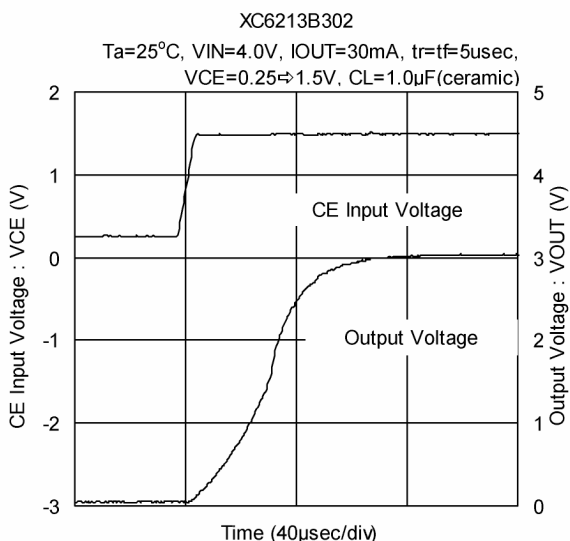
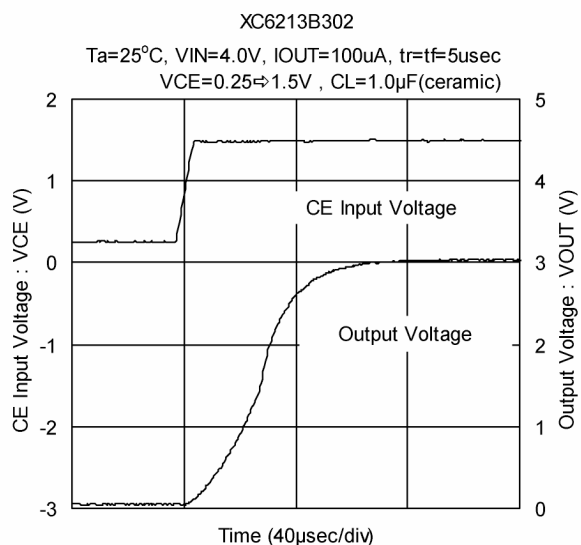

■ TYPICAL PERFORMANCE CHARACTERISTICS (Continued)

(12) Ripple Rejection Rate

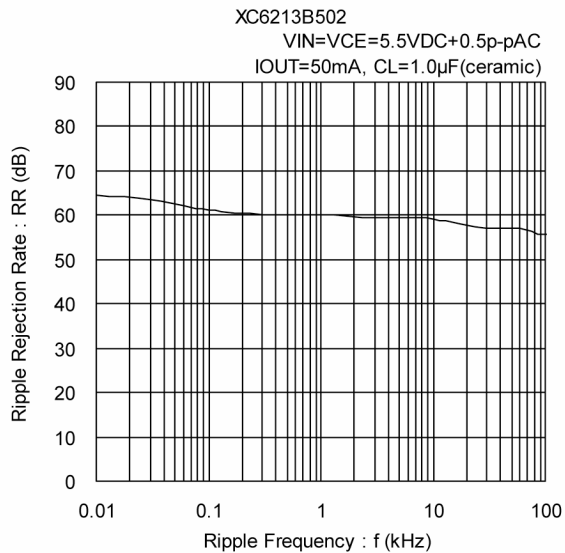
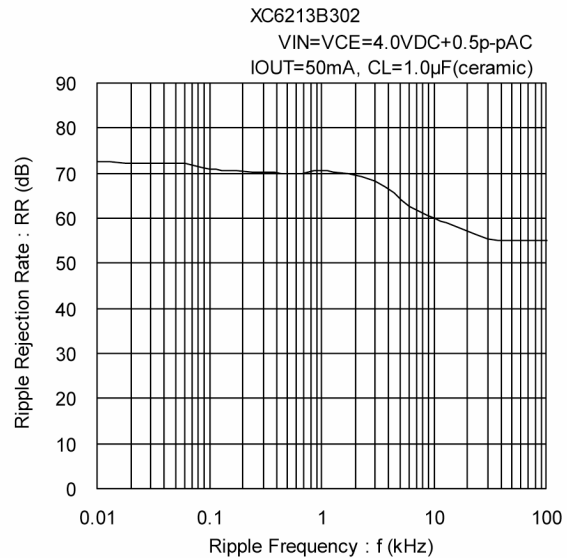
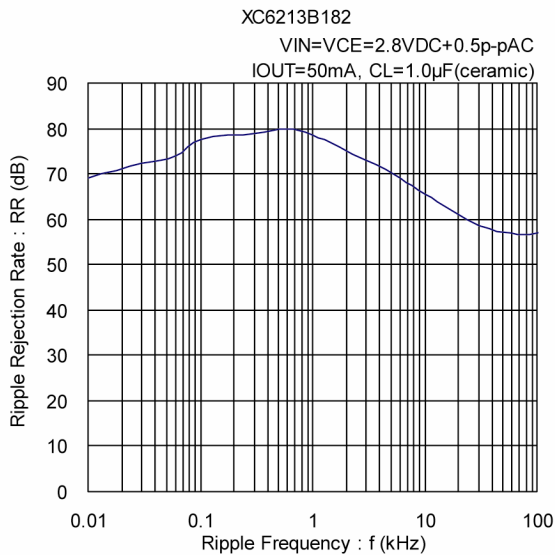
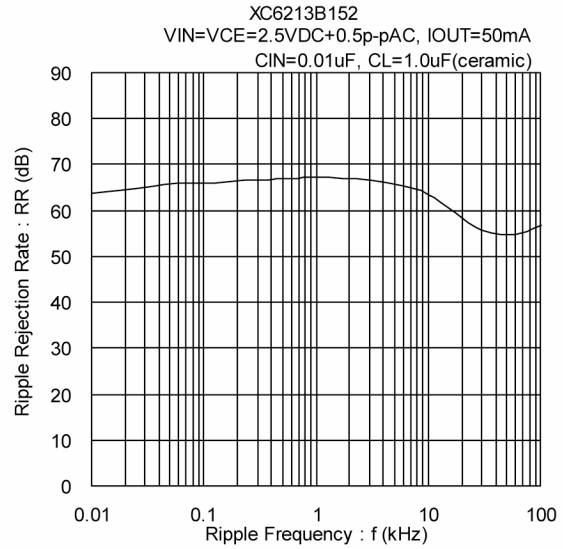
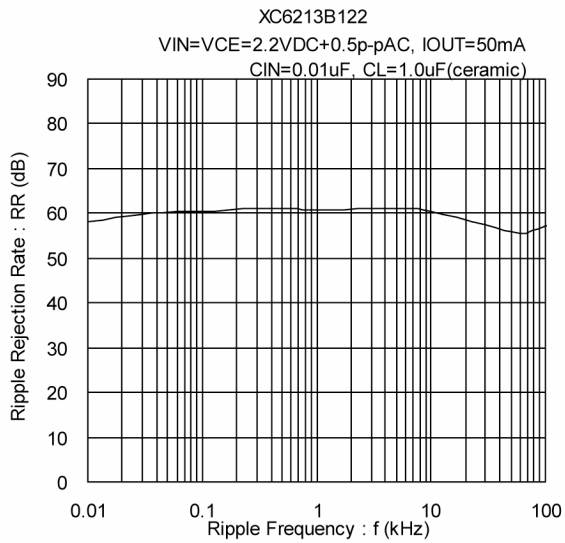

1. The products and product specifications contained herein are subject to change without notice to improve performance characteristics. Consult us, or our representatives before use, to confirm that the information in this catalog is up to date.
2. We assume no responsibility for any infringement of patents, patent rights, or other rights arising from the use of any information and circuitry in this catalog.
3. Please ensure suitable shipping controls (including fail-safe designs and aging protection) are in force for equipment employing products listed in this catalog.
4. The products in this catalog are not developed, designed, or approved for use with such equipment whose failure of malfunction can be reasonably expected to directly endanger the life of, or cause significant injury to, the user.
(e.g. Atomic energy; aerospace; transport; combustion and associated safety equipment thereof.)
5. Please use the products listed in this catalog within the specified ranges.
Should you wish to use the products under conditions exceeding the specifications, please consult us or our representatives.
6. We assume no responsibility for damage or loss due to abnormal use.
7. All rights reserved. No part of this catalog may be copied or reproduced without the prior permission of Torex Semiconductor Ltd.

TOREX SEMICONDUCTOR LTD.