

PolarHV™ HiPerFET Power MOSFET

IXFC16N50P

(Electrically Isolated Back Surface)

N-Channel Enhancement Mode
Avalanche Rated
Fast Intrinsic Diode

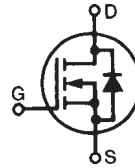

$V_{DSS} = 500V$
 $I_{D25} = 10A$
 $R_{DS(on)} \leq 450m\Omega$
 $t_{rr} \leq 200ns$

Symbol	Test Conditions	Maximum Ratings	
V_{DSS}	$T_J = 25^\circ C$ to $150^\circ C$	500	V
V_{DGR}	$T_J = 25^\circ C$ to $150^\circ C$, $R_{GS} = 1M\Omega$	500	V
V_{GSS}	Continuous	± 30	V
V_{GSM}	Transient	± 40	V
I_{D25}	$T_C = 25^\circ C$	10	A
I_{DM}	$T_C = 25^\circ C$, pulse width limited by T_{JM}	35	A
I_A	$T_C = 25^\circ C$	10	A
E_{AS}	$T_C = 25^\circ C$	750	mJ
dV/dt	$I_S \leq I_{DM}$, $V_{DD} \leq V_{DSS}$, $T_J \leq 150^\circ C$	10	V/ns
P_D	$T_C = 25^\circ C$	125	W
T_J		-55 ... +150	$^\circ C$
T_{JM}		150	$^\circ C$
T_{stg}		-55 ... +150	$^\circ C$
T_L	1.6mm (0.062 in.) from Case for 10s	300	$^\circ C$
T_{SOLD}	Plastic Body for 10s	260	$^\circ C$
V_{ISOL}	50/60 Hz, RMS $I_{ISOL} \leq 1mA$	$t = 1min$ $t = 1s$	2500 3000 V~ V~
M_d	Mounting Force	11..65 / 2.5..14.6	N/lb.
Weight		2	g

ISOPLUS 220™

E153432

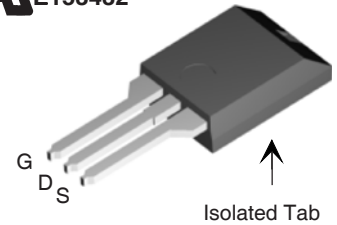

G = Gate
D = Drain
S = Source

Features

- UL Recognized Package
- Silicon Chip on Direct-Copper-Bond Substrate
 - High Power Dissipation
 - Isolated Mounting Surface
 - 2500V Electrical Isolation
- Avalanche Rated
- Fast Intrinsic Diode

Advantages

- Easy to Mount
- Space Savings
- High Power Density

Applications:

- Switched-Mode and Resonant-Mode Power Supplies
- DC-DC Converters
- Laser Drivers
- AC and DC Motor Drives
- Robotics and Servo Controls

Symbol	Test Conditions ($T_J = 25^\circ C$, Unless Otherwise Specified)	Characteristic Values		
		Min.	Typ.	Max.
BV_{DSS}	$V_{GS} = 0V$, $I_D = 250\mu A$	500		V
$V_{GS(th)}$	$V_{DS} = V_{GS}$, $I_D = 2.5mA$	3.0		5.5 V
I_{GSS}	$V_{GS} = \pm 30V$, $V_{DS} = 0V$			± 100 nA
I_{DSS}	$V_{DS} = V_{DSS}$, $V_{GS} = 0V$ $T_J = 125^\circ C$			15 μA 250 μA
$R_{DS(on)}$	$V_{GS} = 10V$, $I_D = 8A$, Note 1			450 m Ω

Symbol	Test Conditions ($T_J = 25^\circ\text{C}$, Unless Otherwise Specified)	Characteristic Values		
		Min.	Typ.	Max.
g_{fs}	$V_{DS} = 20\text{V}$, $I_D = 8\text{A}$, Note 1	9	16	S
C_{iss}	$V_{GS} = 0\text{V}$, $V_{DS} = 25\text{V}$, $f = 1\text{MHz}$		2480	pF
C_{oss}			237	pF
C_{rss}			18	pF
$t_{d(on)}$	Resistive Switching Times $V_{GS} = 10\text{V}$, $V_{DS} = 0.5 \cdot V_{DSS}$, $I_D = 8\text{A}$ $R_G = 10\Omega$ (External)		23	ns
t_r			25	ns
$t_{d(off)}$			70	ns
t_f			22	ns
$Q_{g(on)}$	$V_{GS} = 10\text{V}$, $V_{DS} = 0.5 \cdot V_{DSS}$, $I_D = 8\text{A}$		43	nC
Q_{gs}			15	nC
Q_{gd}			12	nC
R_{thJC}			1.0	$^\circ\text{C/W}$
R_{thCS}		0.21		$^\circ\text{C/W}$

Source-Drain Diode

Symbol	Test Conditions ($T_J = 25^\circ\text{C}$, Unless Otherwise Specified)	Characteristic Values		
		Min.	Typ.	Max.
I_S	$V_{GS} = 0\text{V}$			16 A
I_{SM}	Repetitive, Pulse Width Limited by T_{JM}			64 A
V_{SD}	$I_F = I_S$, $V_{GS} = 0\text{V}$, Note 1			1.5 V
t_{rr}	$I_F = 16\text{A}$, $-di/dt = 100\text{A}/\mu\text{s}$ $V_R = 100\text{V}$, $V_{GS} = 0\text{V}$			200 ns
Q_{RM}			6.0	nC
I_{RM}			0.6	A

Note 1: Pulse Test, $t \leq 300\mu\text{s}$; Duty Cycle, $d \leq 2\%$.

ISOPLUS220™ (IXFC) Outline

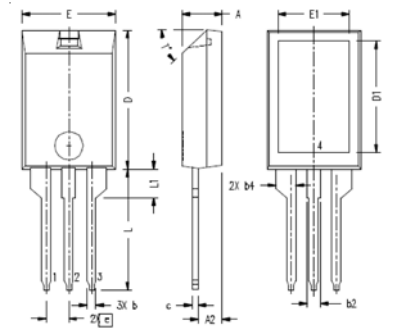

Note:
Bottom heatsink (Pin 4) is electrically isolated from Pin 1, 2, or 3.

SYM	INCHES		MILLIMETERS	
	MIN	MAX	MIN	MAX
A	.157	.197	4.00	5.00
A2	.098	.118	2.50	3.00
b	.035	.051	0.90	1.30
b2	.049	.065	1.25	1.65
b4	.093	.100	2.35	2.55
c	.028	.039	0.70	1.00
D	.591	.630	15.00	16.00
D1	.472	.512	12.00	13.00
E	.394	.433	10.00	11.00
E1	.295	.335	7.50	8.50
e	.100 BASIC		2.55 BASIC	
L	.512	.571	13.00	14.50
L1	.118	.138	3.00	3.50
T*			42.5*	47.5*

Ref: IXYS CO 0177 R0

IXYS Reserves the Right to Change Limits, Test Conditions, and Dimensions.

IXYS MOSFETs and IGBTs are covered by one or more of the following U.S. patents:

4,835,592	4,931,844	5,049,961	5,237,481	6,162,665	6,404,065 B1	6,683,344	6,727,585	7,005,734 B2	7,157,338B2
4,850,072	5,017,508	5,063,307	5,381,025	6,259,123 B1	6,534,343	6,710,405 B2	6,759,692	7,063,975 B2	
4,881,106	5,034,796	5,187,117	5,486,715	6,306,728 B1	6,583,505	6,710,463	6,771,478 B2	7,071,537	

Fig. 1. Output Characteristics @ 25°C

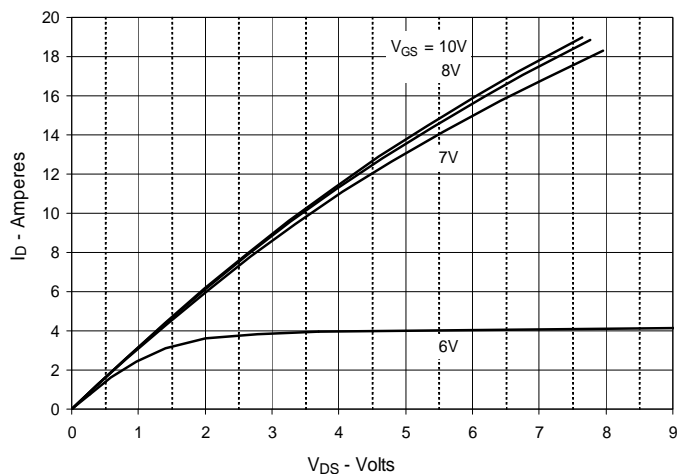

Fig. 2. Output Characteristics @ 125°C

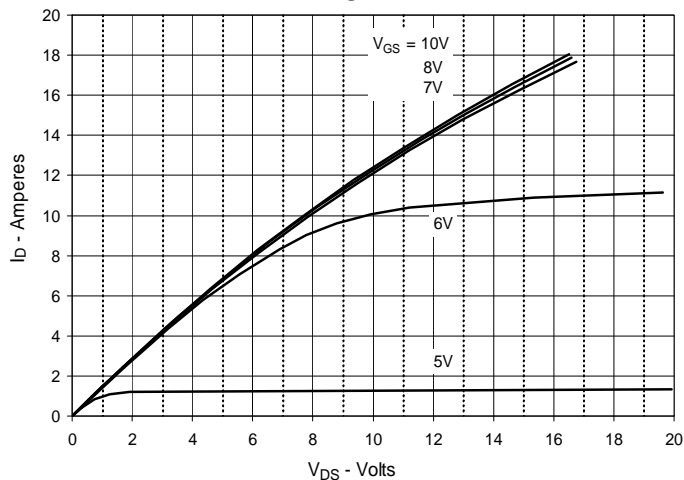

Fig. 3. $R_{DS(on)}$ Normalized to $I_D = 8A$ Value vs. Junction Temperature

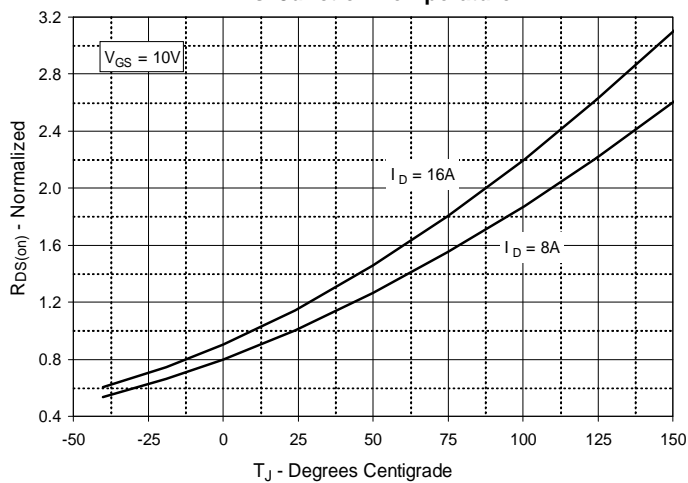

Fig. 4. $R_{DS(on)}$ Normalized to $I_D = 8A$ Value vs. Drain Current

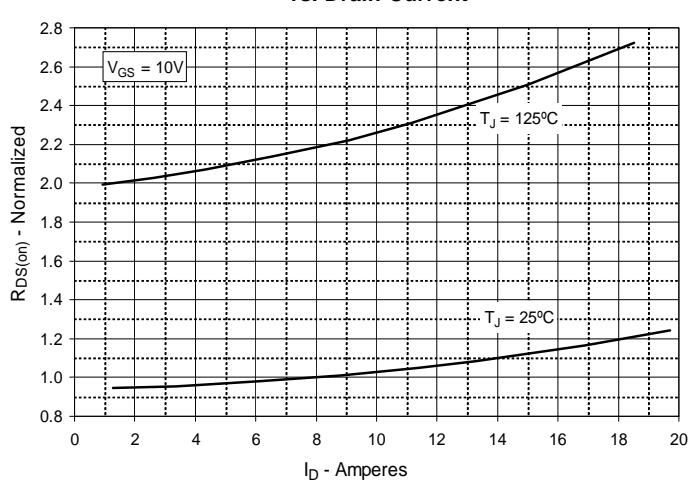

Fig. 5. Maximum Drain Current vs. Case Temperature

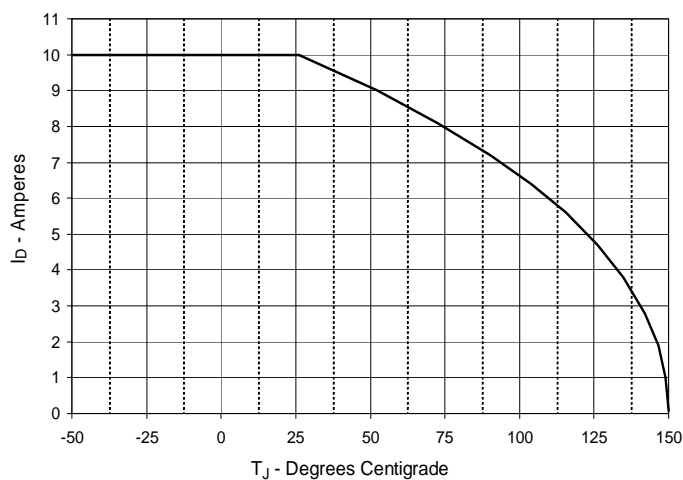

Fig. 6. Input Admittance

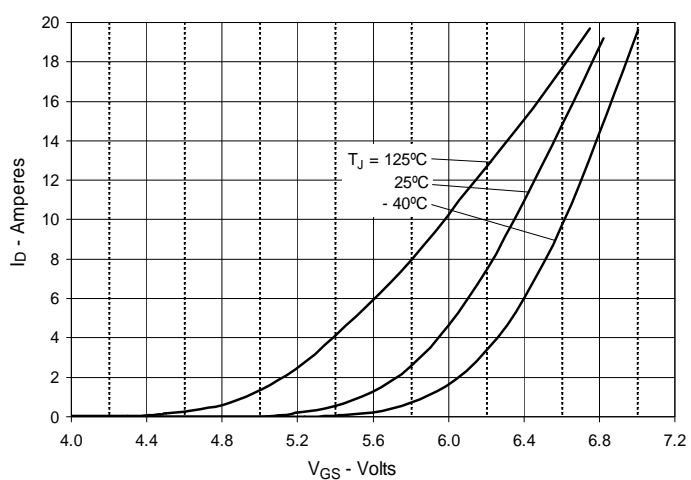

Fig. 7. Transconductance

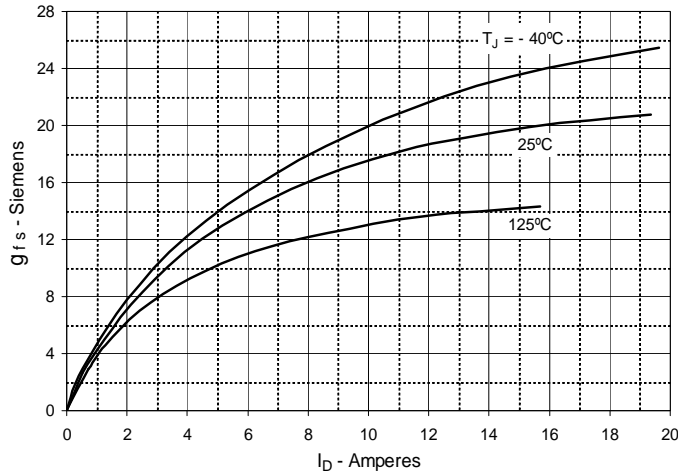

Fig. 8. Forward Voltage Drop of Intrinsic Diode

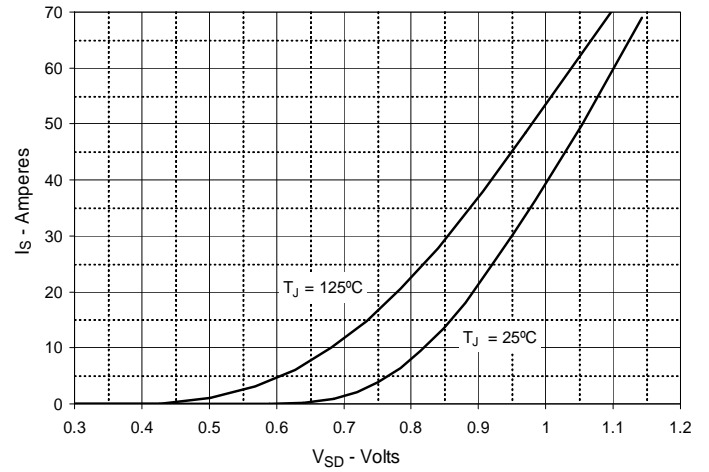

Fig. 9. Gate Charge

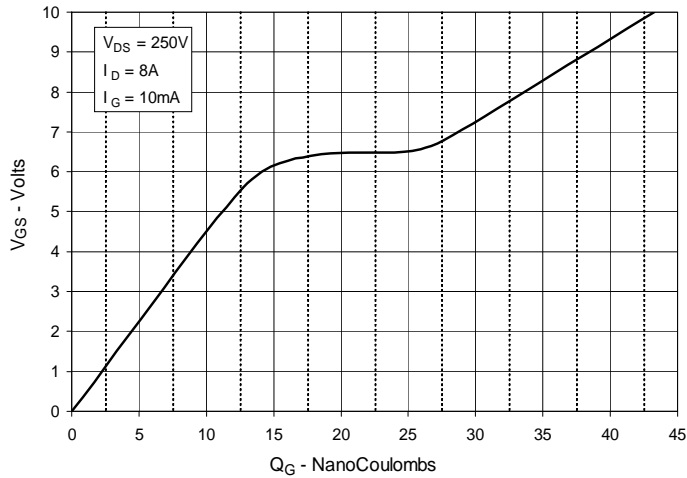

Fig. 10. Capacitance

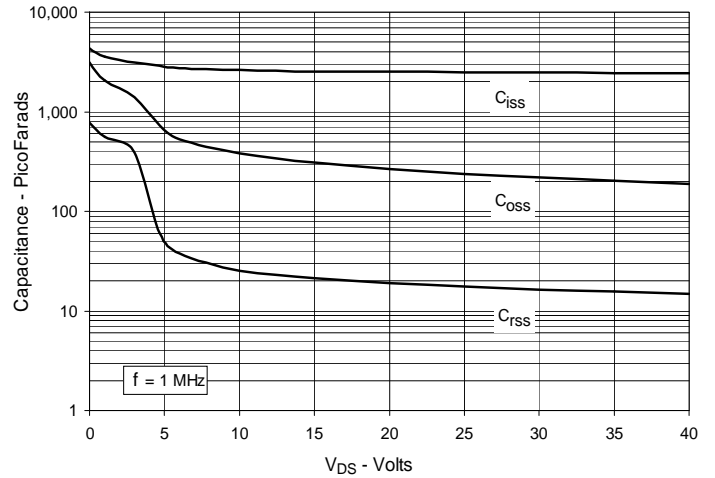

Fig. 11. Forward-Bias Safe Operating Area

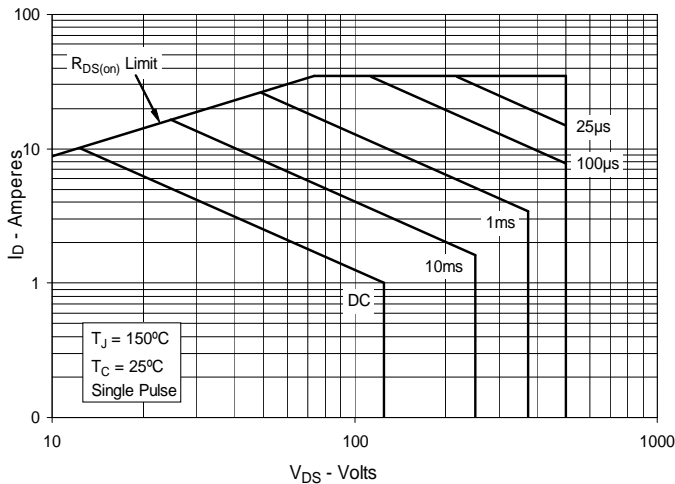

Fig. 12. Maximum Transient Thermal Impedance

