

ADCMP350/ADCMP352/ADCMP354/ADCMP356

FEATURES

Comparators with 0.6 V on-chip references

Output stages:

Open-drain active-low (ADCMP350)

Push-pull active-low (ADCMP352)

Open-drain active-high (ADCMP354)

Push-pull active-high (ADCMP356)

High voltage (up to 22 V) tolerance on V_{IN} and open-drain output pins

Low power consumption (10 μ A)

10 nA input bias current

15 mV hysteresis

5 μ s propagation delay

Specified over -40°C to $+125^{\circ}\text{C}$ temperature range

4-lead SC70 package

APPLICATIONS

Voltage detectors

Microprocessor systems

Computers

Battery monitors

Intelligent instruments

Portable equipment

FUNCTIONAL BLOCK DIAGRAMS

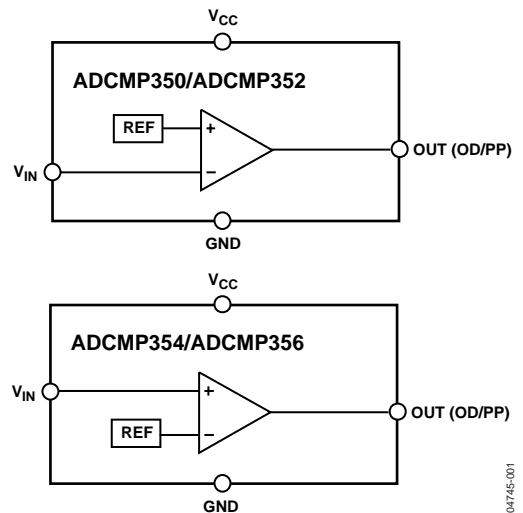

Figure 1.

GENERAL DESCRIPTION

The ADCMP350/ADCMP352/ADCMP354/ADCMP356 parts are comparator and reference circuits suitable for use in general-purpose applications. The high voltage input and output structures will allow voltages of up to 22 V on the input of all devices and the output of the open-drain devices. High performance over the -40°C to $+125^{\circ}\text{C}$ temperature range makes them suitable for use in automotive and other thermally harsh applications, while low power consumption and space-efficient SC70 packaging make them ideal for battery-powered portable equipment.

Table 1. Selection Table

Part No.	Reference Voltage (V)	Input Connection	Output
ADCMP350	0.6	Inverting	Open Drain
ADCMP352	0.6	Inverting	Push-Pull
ADCMP354	0.6	Noninverting	Open Drain
ADCMP356	0.6	Noninverting	Push-Pull

Rev. 0

Information furnished by Analog Devices is believed to be accurate and reliable. However, no responsibility is assumed by Analog Devices for its use, nor for any infringements of patents or other rights of third parties that may result from its use. Specifications subject to change without notice. No license is granted by implication or otherwise under any patent or patent rights of Analog Devices. Trademarks and registered trademarks are the property of their respective owners.

ADCMP350/ADCMP352/ADCMP354/ADCMP356

TABLE OF CONTENTS

Specifications.....	3	Applications.....	9
Absolute Maximum Ratings.....	4	Adding Hysteresis.....	9
ESD Caution.....	4	Voltage Detector	9
Pin Configuration and Function Descriptions.....	5	Outline Dimensions	10
Typical Performance Characteristics	6	Ordering Guide	10

REVISION HISTORY

10/04—Revision 0: Initial Version

SPECIFICATIONS

V_{CC} = Full operating range, T_A = -40°C to $+125^{\circ}\text{C}$, unless otherwise noted.

Table 2.

Parameter	Min	Typ	Max	Unit	Test Conditions/Comments
SUPPLY					
V_{CC} Operating Voltage Range	2.25		5.5	V	
V_{IN} Operating Voltage Range	0		22	V	
Supply Current		10	15	μA	
V_{IN} THRESHOLD RISING	0.579	0.6	0.621	V	$V_{CC} = 3.3\text{V}$, $T_A = -40^{\circ}\text{C}$ to $+85^{\circ}\text{C}$
	0.579	0.6	0.624	V	$V_{CC} = 3.3\text{V}$, $T_A = -40^{\circ}\text{C}$ to $+125^{\circ}\text{C}$
V_{IN} THRESHOLD FALLING	0.564	0.585	0.606	V	$V_{CC} = 3.3\text{V}$, $T_A = -40^{\circ}\text{C}$ to $+85^{\circ}\text{C}$
	0.564	0.585	0.609	V	$V_{CC} = 3.3\text{V}$, $T_A = -40^{\circ}\text{C}$ to $+125^{\circ}\text{C}$
INPUT BIAS CURRENT		10		nA	$V_{IN} = 0.6\text{V}$
		170		μA	$V_{IN} = 22\text{V}$
THRESHOLD TEMPERATURE COEFFICIENT		30		ppm/ $^{\circ}\text{C}$	
V_{IN} TO OUT DELAY		5		μs	$V_{IN} = V_{TH}$ to $(V_{TH} - 100\text{mV})$
OUT VOLTAGE LOW			0.4	V	$V_{IN} < V_{TH\text{min}}$, $I_{SINK} = 1.2\text{mA}$
OUT VOLTAGE HIGH	$0.8 \times V_{CC}$			V	$V_{IN} > V_{TH\text{max}}$, $I_{SOURCE} = 500\mu\text{A}$, Push-pull only
OUTPUT RISE TIME		30		ns	$C_{out} = 15\text{pF}$
OUTPUT FALL TIME		45		ns	$C_{out} = 15\text{pF}$
OUTPUT LEAKAGE CURRENT			1	μA	OUT = 22 V, open drain only

ADCMP350/ADCMP352/ADCMP354/ADCMP356

ABSOLUTE MAXIMUM RATINGS

T_A = 25°C, unless otherwise noted.

Table 3.

Parameter	Rating
V _{CC}	−0.3 V to +6 V
V _{IN}	−0.3 V to +25 V
OUT (Open Drain)	−0.3 V to +25 V
OUT (Push-Pull)	−0.3 V to (V _{CC} + 0.3 V)
Operating Temperature Range	−40°C to +125°C
Storage Temperature Range	−65°C to +150°C
θ _{JA} Thermal Impedance, SC70	146°C/W
Lead Temperature	
Soldering (10 sec)	300°C
Vapor Phase (60 sec)	215°C
Infrared (15 sec)	220°C

Stresses above those listed under Absolute Maximum Ratings may cause permanent damage to the device. This is a stress rating only and functional operation of the device at these or any other conditions above those indicated in the operational section of this specification is not implied. Exposure to absolute maximum rating conditions for extended periods may affect device reliability.

ESD CAUTION

ESD (electrostatic discharge) sensitive device. Electrostatic charges as high as 4000 V readily accumulate on the human body and test equipment and can discharge without detection. Although this product features proprietary ESD protection circuitry, permanent damage may occur on devices subjected to high energy electrostatic discharges. Therefore, proper ESD precautions are recommended to avoid performance degradation or loss of functionality.



ADCMP350/ADCMP352/ADCMP354/ADCMP356

PIN CONFIGURATION AND FUNCTION DESCRIPTIONS

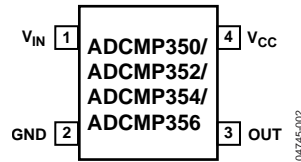

Figure 2. Pin Configuration

Table 4. Pin Function Descriptions

Pin No.	Mnemonic	Description
1	V _{IN}	Monitors Analog Input Voltage. Connected to inverting or noninverting input, depending on model number.
2	GND	Ground.
3	OUT	Digital Output. Open-drain or push-pull options, depending on model number.
4	V _{CC}	Power Supply.

ADCMP350/ADCMP352/ADCMP354/ADCMP356

TYPICAL PERFORMANCE CHARACTERISTICS

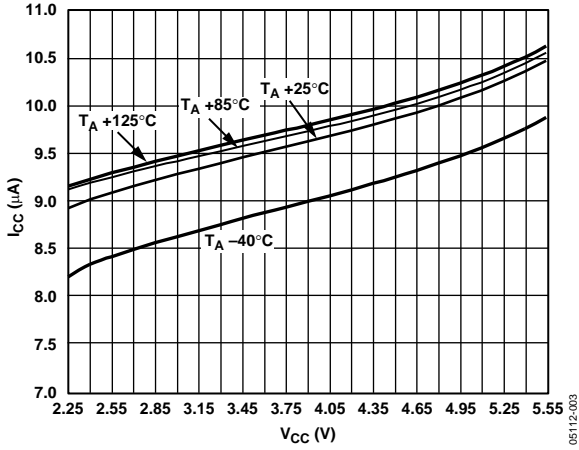

Figure 3. I_{CC} vs. V_{CC} over Temperature.

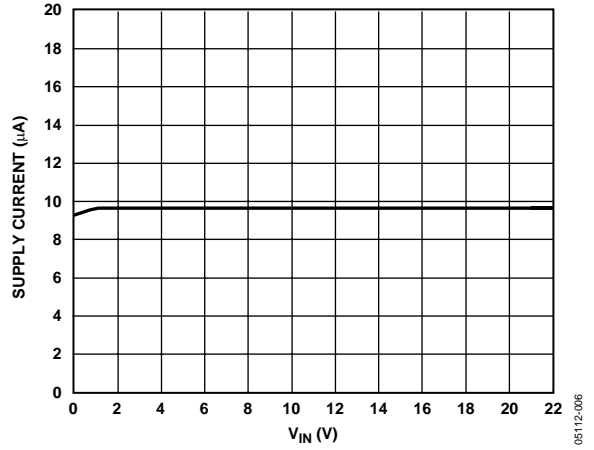

Figure 6. Supply Current vs. Input Voltage

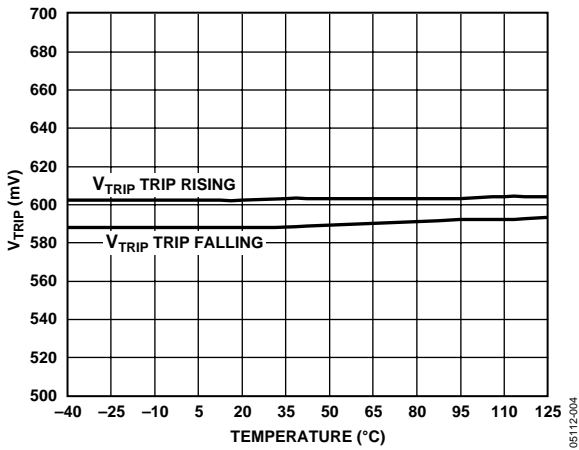

Figure 4. V_{IN} Trip Threshold vs. Temperature. ($V_{CC} = 3.3V$)

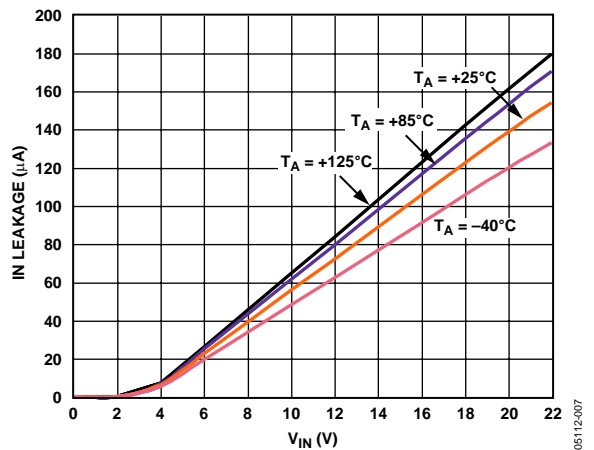

Figure 7. Input Leakage vs. Input Voltage

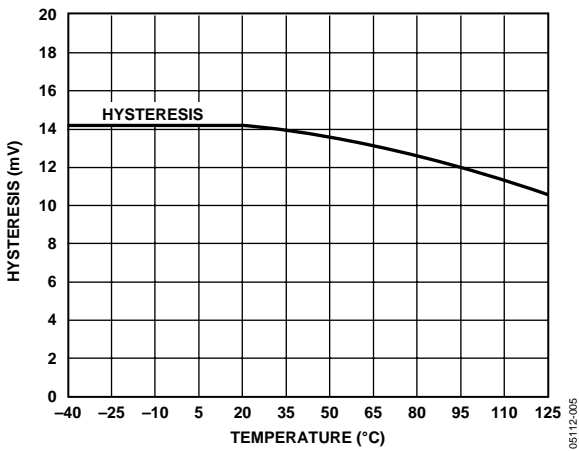

Figure 5. V_{IN} Trip Hysteresis vs. Temperature

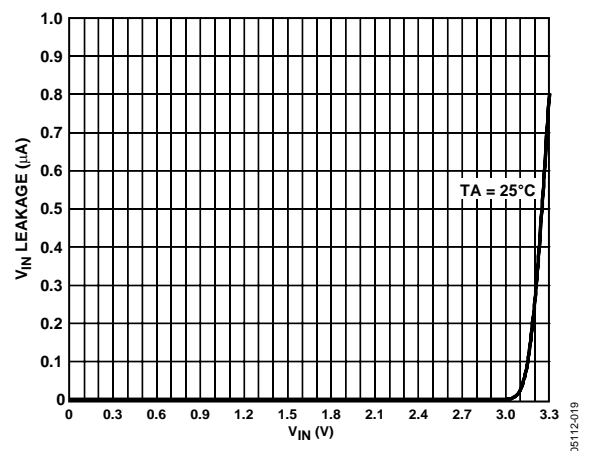

Figure 8. V_{IN} Leakage Current vs. V_{IN} Voltage ($V_{CC} = 3.8V$)

ADCMP350/ADCMP352/ADCMP354/ADCMP356

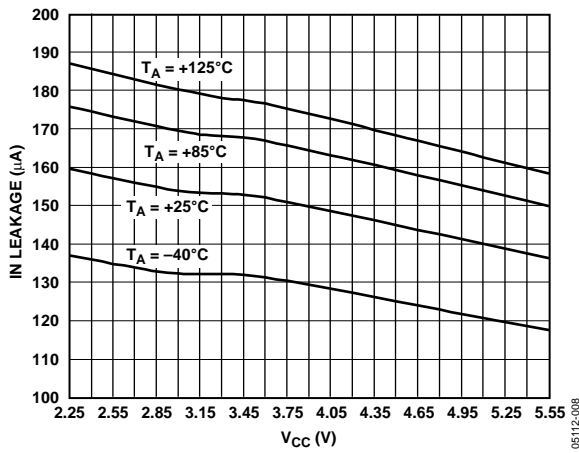

Figure 9. Input Leakage vs. Supply Voltage ($V_{IN} = 22\text{ V}$)

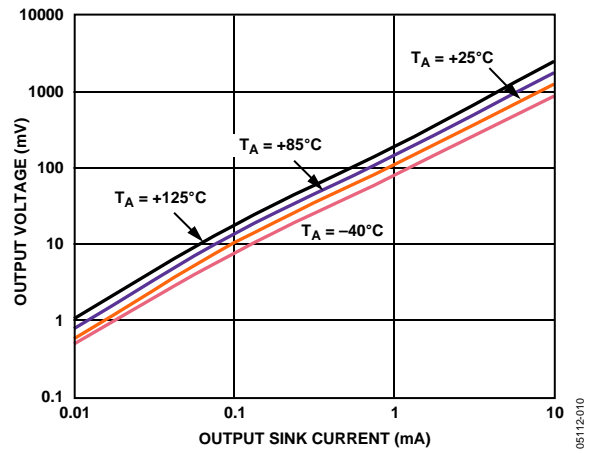

Figure 12. Output Voltage vs. Output Sink Current ($I_{sink} = 500\text{ mA}$)

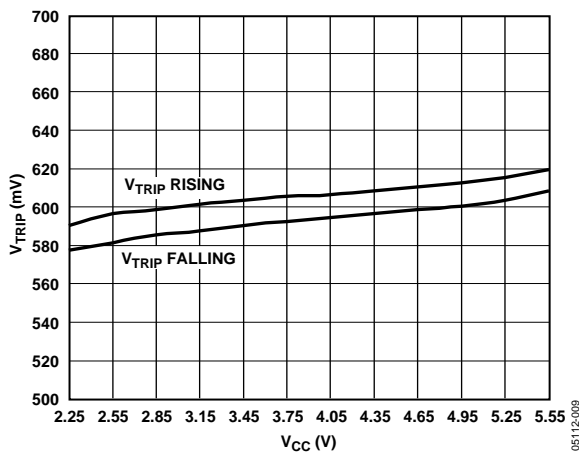

Figure 10. V_{IN} Trip Threshold vs. V_{CC}

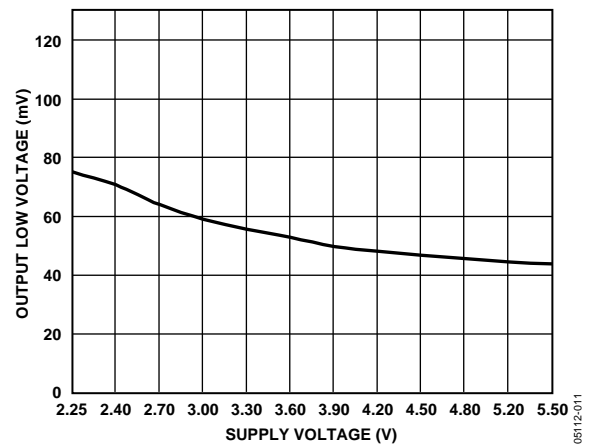

Figure 13. Output Low Voltage vs. Supply Voltage ($I_{sink} = 500\text{ mA}$)

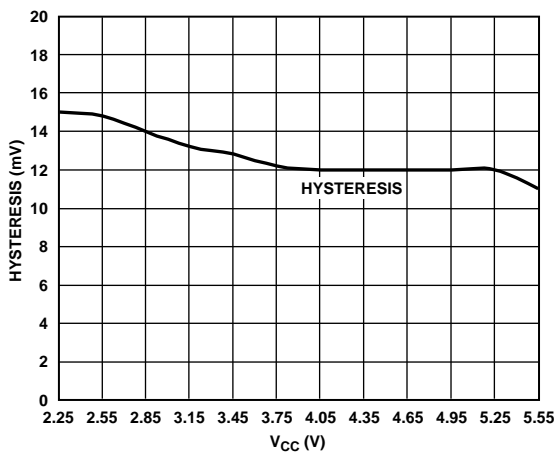

Figure 11. V_{IN} Trip Hysteresis vs. V_{CC}

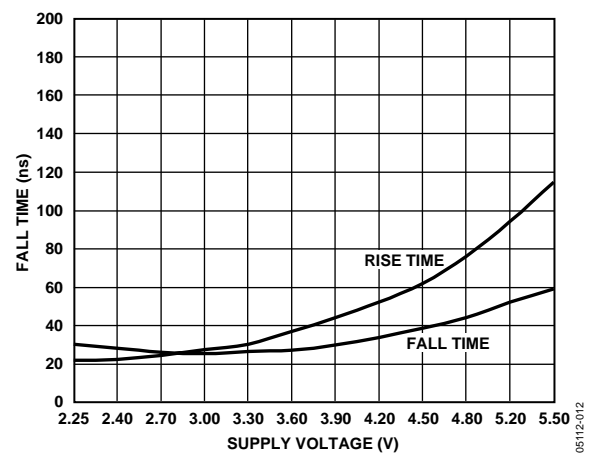

Figure 14. Fall Time vs. Supply Voltage

ADCMP350/ADCMP352/ADCMP354/ADCMP356

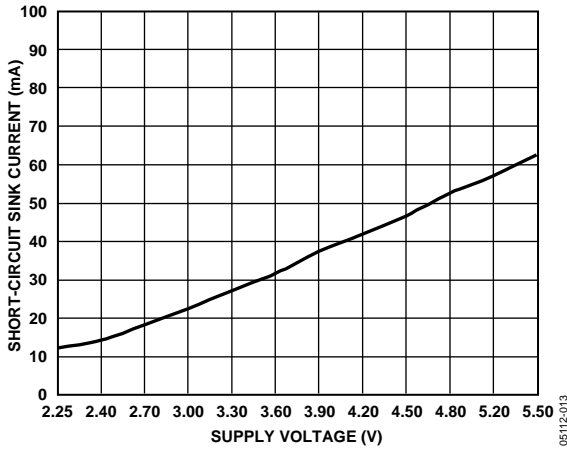

Figure 15. Short-Circuit Sink Current vs. Supply Voltage ($V_{CC} = 3.3$, PUSH-PULL Only)

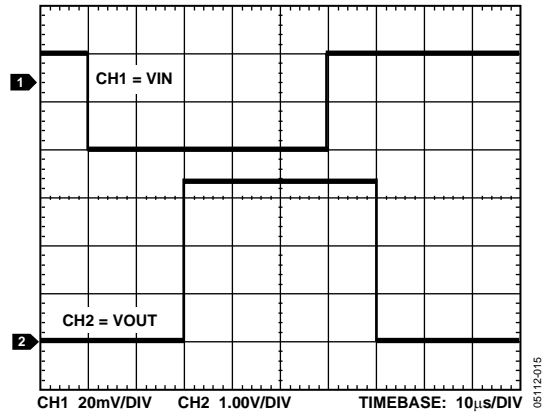

Figure 17. Propagation Delay Timing, 10 mV Overdrive

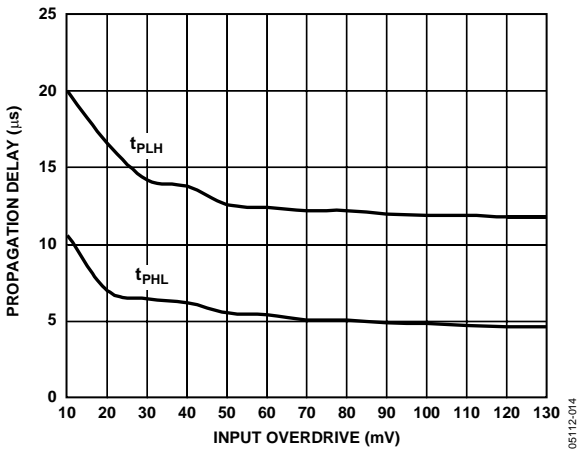

Figure 16. Propagation Delay vs. Input Overdrive ($V_{CC} = 3.3$, PUSH-PULL Only)

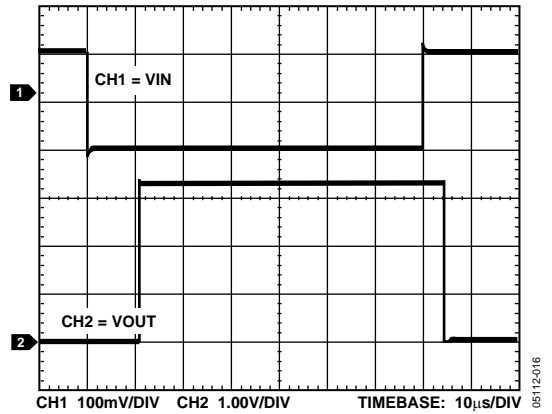

Figure 18. Propagation Delay Timing, 100 mV Overdrive

APPLICATIONS

ADDING HYSTERESIS

To prevent oscillations at the output caused by noise or slowly moving signals passing the switching threshold, positive feedback can be used to add hysteresis to the noninverting parts (ADCMP354 and ADCMP356).

For the noninverting configuration shown in Figure 19, two resistors are used to create different switching thresholds, depending on whether the input signal is increasing or decreasing in magnitude. When the input voltage is increasing, the threshold is above V_{REF} , and when it's decreasing, the threshold is below V_{REF} .

The upper input threshold level is given by

$$V_{IN_HI} = \frac{V_{REF}(R1 + R2) - V_{CC}R1}{R2}$$

where $V_{REF} = 0.6$ V.

The lower input threshold level is given by

$$V_{IN_LO} = \frac{V_{REF}(R1 + R2)}{R2}$$

The hysteresis is the difference between these voltage levels and is given by

$$\Delta V_{IN} = \frac{V_{CC}R1}{R2}$$

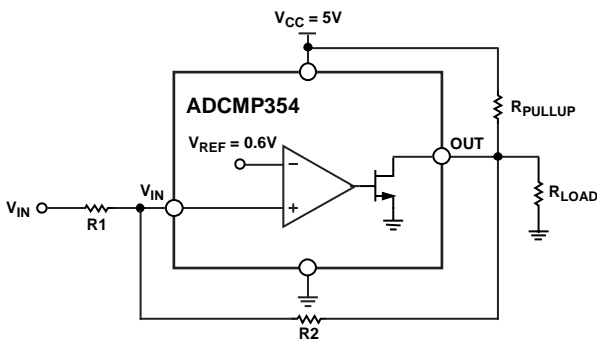

Figure 19. Noninverting Comparator Configuration with Hysteresis

VOLTAGE DETECTOR

The ADCMP35x parts can be used to monitor voltages, such as battery monitoring or threshold detectors. Using a resistor divider at the input to select the appropriate trip voltage, the comparator can be configured to give a logic output when the input passes that threshold. Figure 20 shows the typical configuration of the ADCMP354 for monitoring a supply to indicate that the voltage is above a certain level.

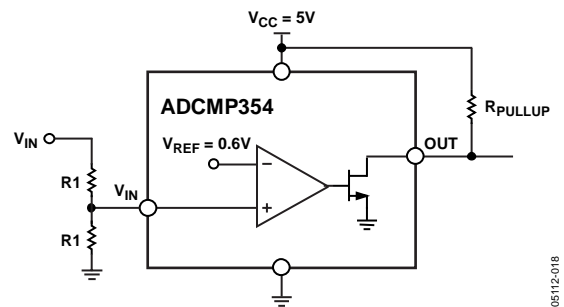
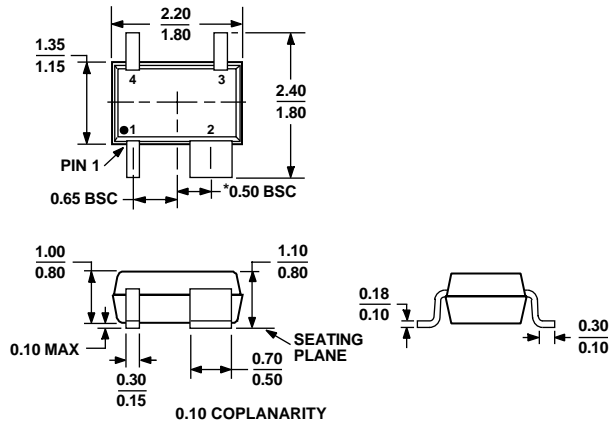

Figure 20. Voltage Detector Application

ADCMP350/ADCMP352/ADCMP354/ADCMP356

OUTLINE DIMENSIONS



*PACKAGE OUTLINE CORRESPONDS IN FULL TO EIAJ SC82 EXCEPT FOR WIDTH OF PIN-2 AS SHOWN

Figure 21. 4-Lead Thin Shrink Small Outline Transistor Package [SC70]
(EIAJ SC82 body)
(KS-4)

Dimensions shown in millimeters

ORDERING GUIDE

Model	Temperature Range	Package Description	Branding	Package Option
ADCMP350YKS-REEL7	-40°C to +125°C	4-Lead SC70	M0Z	KS-4
ADCMP352YKS-REEL7	-40°C to +125°C	4-Lead SC70	M11	KS-4
ADCMP354YKS-REEL7	-40°C to +125°C	4-Lead SC70	M13	KS-4
ADCMP356YKS-REEL7	-40°C to +125°C	4-Lead SC70	M15	KS-4

NOTES

ADCMP350/ADCMP352/ADCMP354/ADCMP356

NOTES