

BLF6G27L-50BN; BLF6G27LS-50BN

Power LDMOS transistor

Rev. 2 — 7 April 2011

Product data sheet

1. Product profile

1.1 General description

50 W LDMOS power transistor for base station applications at frequencies from 2500 MHz to 2700 MHz.

Table 1. Typical performance

RF performance at $T_{case} = 25\text{ °C}$ in a common source class-AB production test circuit.

Mode of operation	f (MHz)	I_{Dq} (mA)	V_{DS} (V)	$P_{L(AV)}$ (W)	G_p (dB)	η_D (%)	ACPR (dBc)
2-carrier W-CDMA	2500 to 2700	430	28	3	16.5	14.5	-47 ^[1]

[1] Test signal: 3GPP; test model 1; 64 DPCH; PAR = 8.4 dB at 0.01 % probability on CCDF per carrier; carrier spacing 5 MHz

1.2 Features and benefits

- Typical 2-carrier W-CDMA performance at frequencies of 2500 MHz and 2700 MHz, a supply voltage of 28 V and an I_{Dq} of 430 mA:
 - ◆ Average output power = 3 W
 - ◆ Power gain = 16.5 dB (typical)
 - ◆ Efficiency = 14.5 %
 - ◆ ACPR = -47 dBc
- Easy power control
- Integrated ESD protection
- Excellent ruggedness
- High efficiency
- Excellent thermal stability
- Designed for broadband operation (2500 MHz to 2700 MHz)
- Internally matched for ease of use
- Integrated current sense
- Compliant to Restriction of Hazardous Substances (RoHS) Directive 2002/95/EC

1.3 Applications

- RF power amplifiers for base stations and multi carrier applications in the 2500 MHz to 2700 MHz frequency range



2. Pinning information

Table 2. Pinning

Pin	Description	Simplified outline	Graphic symbol
BLF6G27L-50BN (SOT1112A)			
1	drain		
2	gate		
3	source		
4, 5	sense drain		
6, 7	sense gate		
BLF6G27LS-50BN (SOT1112B)			
1	drain		
2	gate		
3	source		
4, 5	sense drain		
6, 7	sense gate		

[1] Connected to flange.

3. Ordering information

Table 3. Ordering information

Type number	Package		
	Name	Description	Version
BLF6G27L-50BN	-	flanged ceramic package; 2 mounting holes; 6 leads	SOT1112A
BLF6G27LS-50BN	-	earless flanged ceramic package; 6 leads	SOT1112B

4. Limiting values

Table 4. Limiting values

In accordance with the Absolute Maximum Rating System (IEC 60134).

Symbol	Parameter	Conditions	Min	Max	Unit
V_{DS}	drain-source voltage		-	65	V
V_{GS}	gate-source voltage		-0.5	+13	V
$V_{GS(sense)}$	sense gate-source voltage		-0.5	+9	V
I_D	drain current		-	12	A
T_{stg}	storage temperature		-65	+150	°C
T_j	junction temperature		-	200	°C

5. Thermal characteristics

Table 5. Thermal characteristics

Symbol	Parameter	Conditions	Typ	Unit
$R_{th(j-case)}$	thermal resistance from junction to case	$T_{case} = 80\text{ °C}; P_L = 12.5\text{ W (CW)}$	1.3	K/W

6. Characteristics

Table 6. Characteristics

$T_j = 25\text{ °C}$ per section; unless otherwise specified

Symbol	Parameter	Conditions	Min	Typ	Max	Unit
$V_{(BR)DSS}$	drain-source breakdown voltage	$V_{GS} = 0\text{ V}; I_D = 0.5\text{ mA}$	65	-	-	V
$V_{GS(th)}$	gate-source threshold voltage	$V_{DS} = 10\text{ V}; I_D = 72\text{ mA}$	1.4	1.9	2.4	V
I_{Dq}	quiescent drain current	sense transistor: $I_{DS} = 9.1\text{ mA};$ $V_{DS} = 26.5\text{ V}$ main transistor: $V_{DS} = 28\text{ V}$	380	430	480	mA
I_{DSS}	drain leakage current	$V_{GS} = 0\text{ V}; V_{DS} = 28\text{ V}$	-	-	1.5	μA
I_{DSX}	drain cut-off current	$V_{GS} = V_{GS(th)} + 3.75\text{ V};$ $V_{DS} = 10\text{ V}$	10	12	-	A
I_{GSS}	gate leakage current	$V_{GS} = 11\text{ V}; V_{DS} = 0\text{ V}$	-	-	150	nA
g_{fs}	forward transconductance	$V_{DS} = 10\text{ V}; I_D = 3.6\text{ A}$	-	5.0	-	S
$R_{DS(on)}$	drain-source on-state resistance	$V_{GS} = V_{GS(th)} + 3.75\text{ V};$ $I_D = 2.52\text{ A}$	-	0.25	-	Ω

7. Application information

Table 7. 2-carrier W-CDMA application information

All testing performed in Class-AB production test circuit; test signal 3GPP; test model 1; 64 DPCH; PAR = 8.4 dB at 0.01 % probability on CCDF per carrier; carrier spacing 5 MHz; $f_1 = 2500\text{ MHz};$ $f_2 = 2600\text{ MHz};$ $f_3 = 2700\text{ MHz};$ RF performance at $V_{DS} = 28\text{ V}; I_{Dq} = 430\text{ mA}; T_{case} = 25\text{ °C};$ unless otherwise specified.

Symbol	Parameter	Conditions	Min	Typ	Max	Unit
$P_{L(AV)}$	average output power		-	3	-	W
G_p	power gain	$P_{L(AV)} = 3\text{ W}$	15.3	16.5	-	dB
η_D	drain efficiency	$P_{L(AV)} = 3\text{ W}$	12.5	14.5	-	%
ACPR	adjacent channel power ratio	$P_{L(AV)} = 3\text{ W}$	-	-47	-43	dBc
I_{Dq}	quiescent drain current	$V_{DD} = 28\text{ V}$	-	430	-	mA

Table 8. 1-carrier W-CDMA application information

All testing performed in Class-AB production test circuit; test signal 3GPP; test model 1; 64 DPCH; PAR = 7.2 dB at 0.01 % probability on CCDF per carrier; f = 2700 MHz; RF performance at $V_{DS} = 28\text{ V}$; $I_{Dq} = 430\text{ mA}$; $T_{case} = 25\text{ }^\circ\text{C}$; unless otherwise specified.

Symbol	Parameter	Conditions	Min	Typ	Max	Unit
PAR _O	output peak-to-average ratio	$P_{L(AV)} = 16\text{ W}$	4.1	4.7	5.3	dB

7.1 Ruggedness in Class-AB operation

The BLF6G27L-50BN and BLF6G27LS-50BN are capable of withstanding a load mismatch corresponding to VSWR = 10 : 1 through all phases under the following conditions: $V_{DS} = 28\text{ V}$; $I_{Dq} = 430\text{ mA}$; $P_L = 40\text{ W (CW)}$; f = 2500 MHz.

7.2 Single carrier IS-95

Single carrier IS-95 with pilot, paging, sync and 6 traffic channels (Walsh codes 8 - 13). PAR = 9.7 dB at 0.01 % probability on the CCDF. Channel bandwidth is 1.2288 MHz.

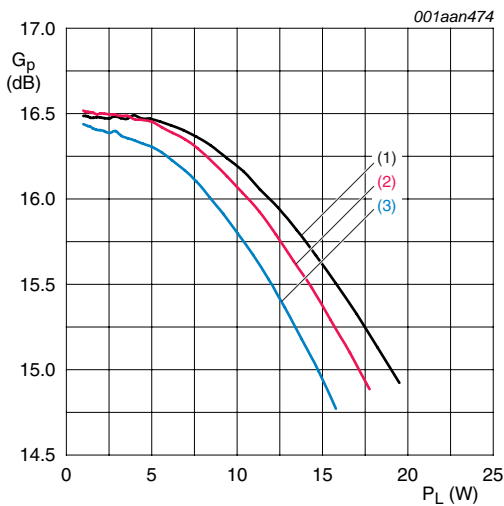

$V_{DS} = 28\text{ V}$; $I_{Dq} = 430\text{ mA}$.

- (1) f = 2500 MHz
- (2) f = 2600 MHz
- (3) f = 2700 MHz

Fig 1. Single carrier IS-95 power gain as a function of load power; typical values

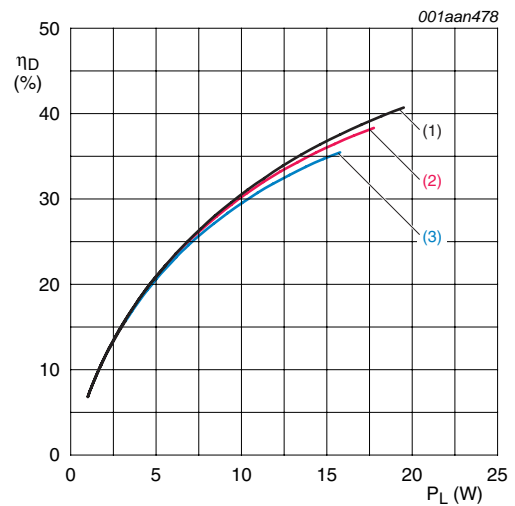

$V_{DS} = 28\text{ V}$; $I_{Dq} = 430\text{ mA}$.

- (1) f = 2500 MHz
- (2) f = 2600 MHz
- (3) f = 2700 MHz

Fig 2. Single carrier IS-95 drain efficiency as a function of load power; typical values

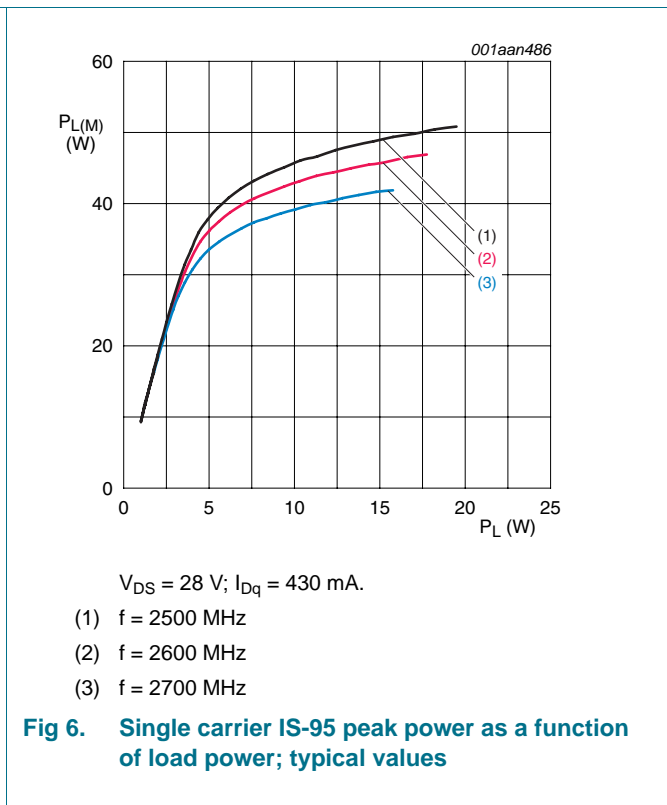
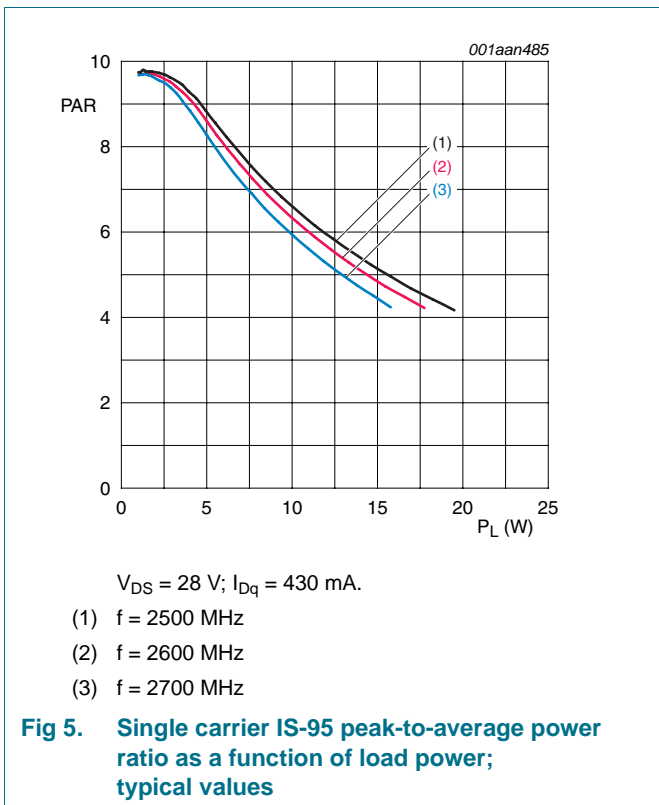
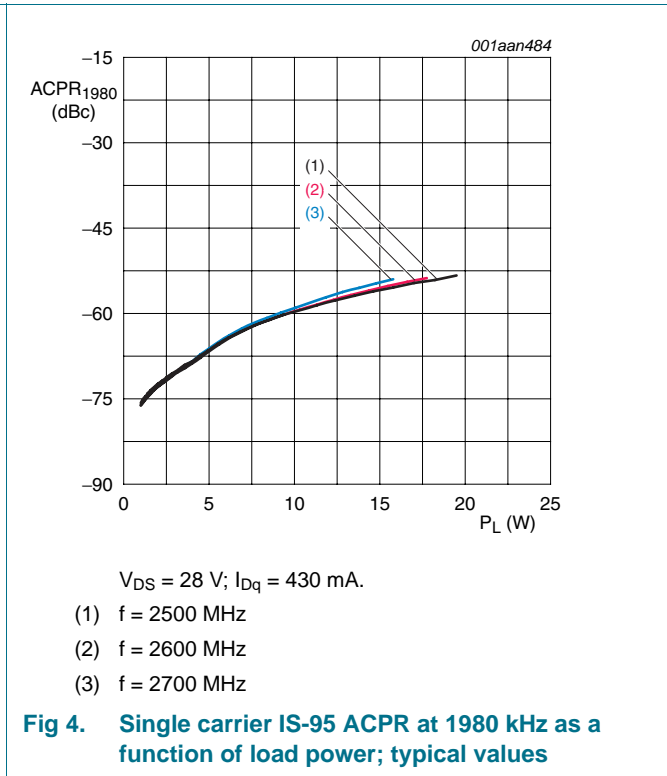
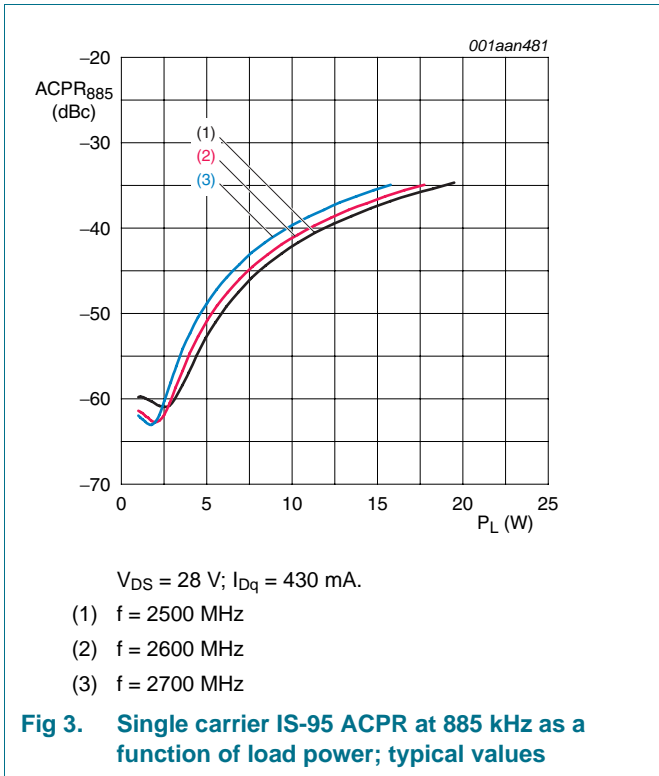

7.3 Pulsed CW

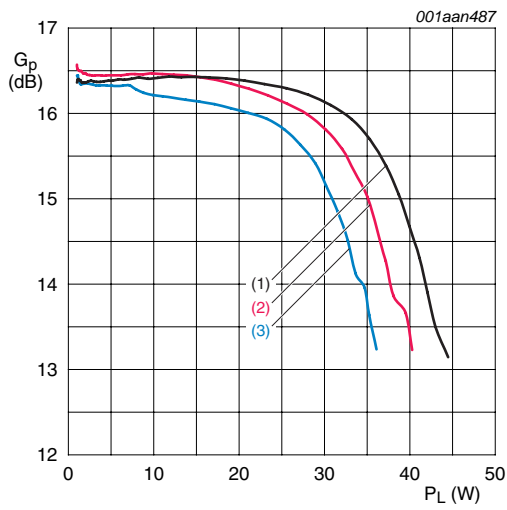

$V_{DS} = 28\text{ V}; I_{Dq} = 430\text{ mA}.$
 (1) $f = 2500\text{ MHz}$
 (2) $f = 2600\text{ MHz}$
 (3) $f = 2700\text{ MHz}$

Fig 7. Pulsed CW power gain as a function of load power; typical values

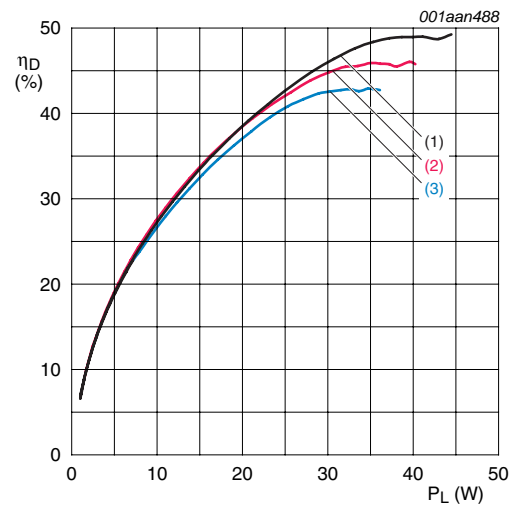

$V_{DS} = 28\text{ V}; I_{Dq} = 430\text{ mA}.$
 (1) $f = 2500\text{ MHz}$
 (2) $f = 2600\text{ MHz}$
 (3) $f = 2700\text{ MHz}$

Fig 8. Pulsed CW drain efficiency as a function of load power; typical values

7.4 2-carrier W-CDMA

All testing performed in Class-AB production test circuit; test signal 3GPP; test model 1; 64 DPCH; PAR = 8.4 dB at 0.01 % probability on CCDF per carrier; carrier spacing 5 MHz; $f_1 = 2500$ MHz; $f_2 = 2600$ MHz; $f_3 = 2700$ MHz; $T_{case} = 25$ °C; unless otherwise specified.

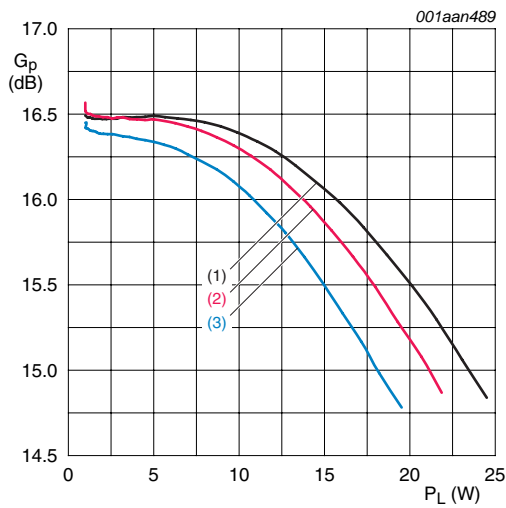

$V_{DS} = 28$ V; $I_{Dq} = 430$ mA.
 (1) $f = 2500$ MHz
 (2) $f = 2600$ MHz
 (3) $f = 2700$ MHz

Fig 9. 2-carrier W-CDMA power gain as a function of load power; typical values

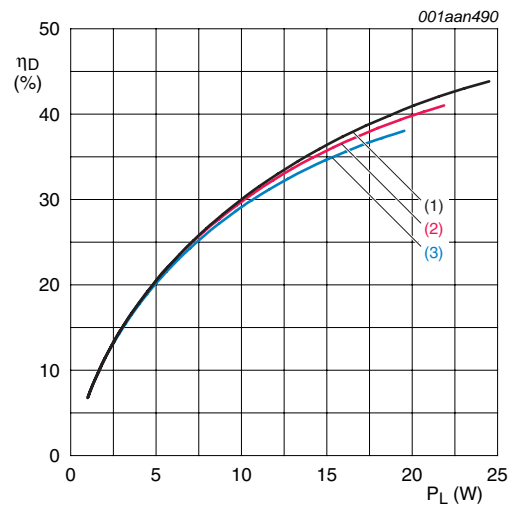

$V_{DS} = 28$ V; $I_{Dq} = 430$ mA.
 (1) $f = 2500$ MHz
 (2) $f = 2600$ MHz
 (3) $f = 2700$ MHz

Fig 10. 2-carrier W-CDMA drain efficiency as a function of load power; typical values

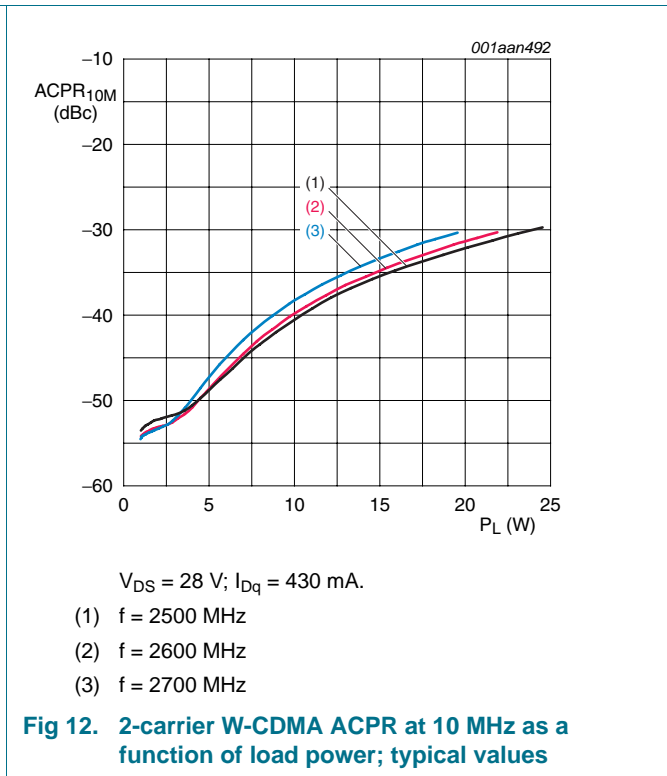
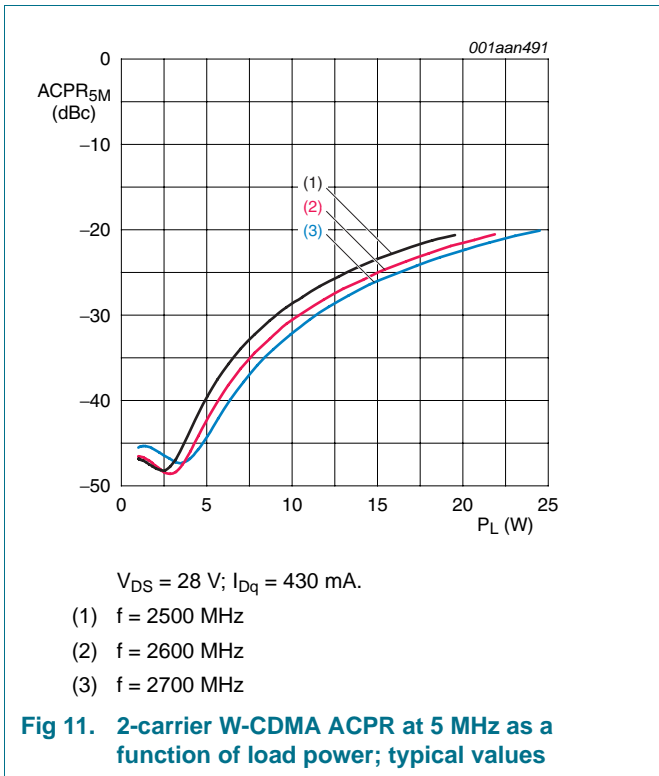

7.5 Single carrier W-CDMA

All testing performed in Class-AB production test circuit; test signal 3GPP; test model 1; 64 DPCH; PAR = 7.2 dB at 0.01 % probability on CCDF per carrier; f = 2700 MHz; $T_{case} = 25\text{ }^{\circ}\text{C}$; unless otherwise specified.

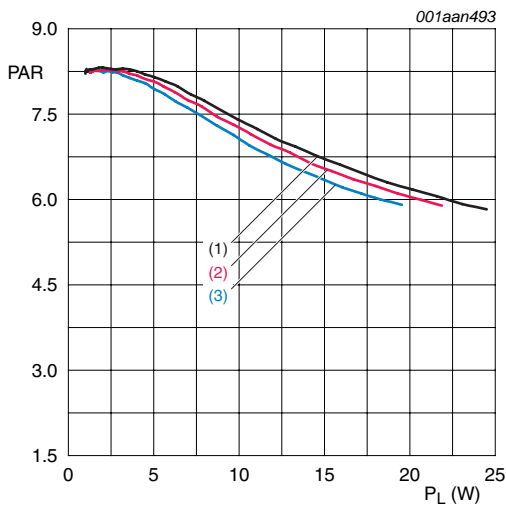

$V_{DS} = 28\text{ V}$; $I_{Dq} = 430\text{ mA}$.
 (1) f = 2500 MHz
 (2) f = 2600 MHz
 (3) f = 2700 MHz

Fig 13. Single carrier W-CDMA peak-to-average power ratio as a function of load power; typical values

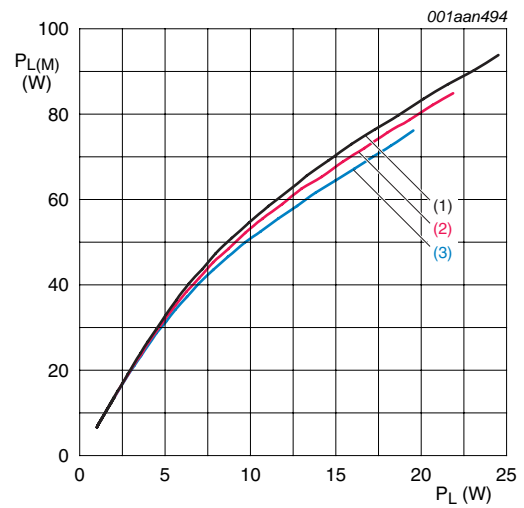

$V_{DS} = 28\text{ V}$; $I_{Dq} = 430\text{ mA}$.
 (1) f = 2500 MHz
 (2) f = 2600 MHz
 (3) f = 2700 MHz

Fig 14. Single carrier W-CDMA peak output power as a function of load power; typical values

8. Package outline

Flanged ceramic package; 2 mounting holes; 6 leads

SOT1112A

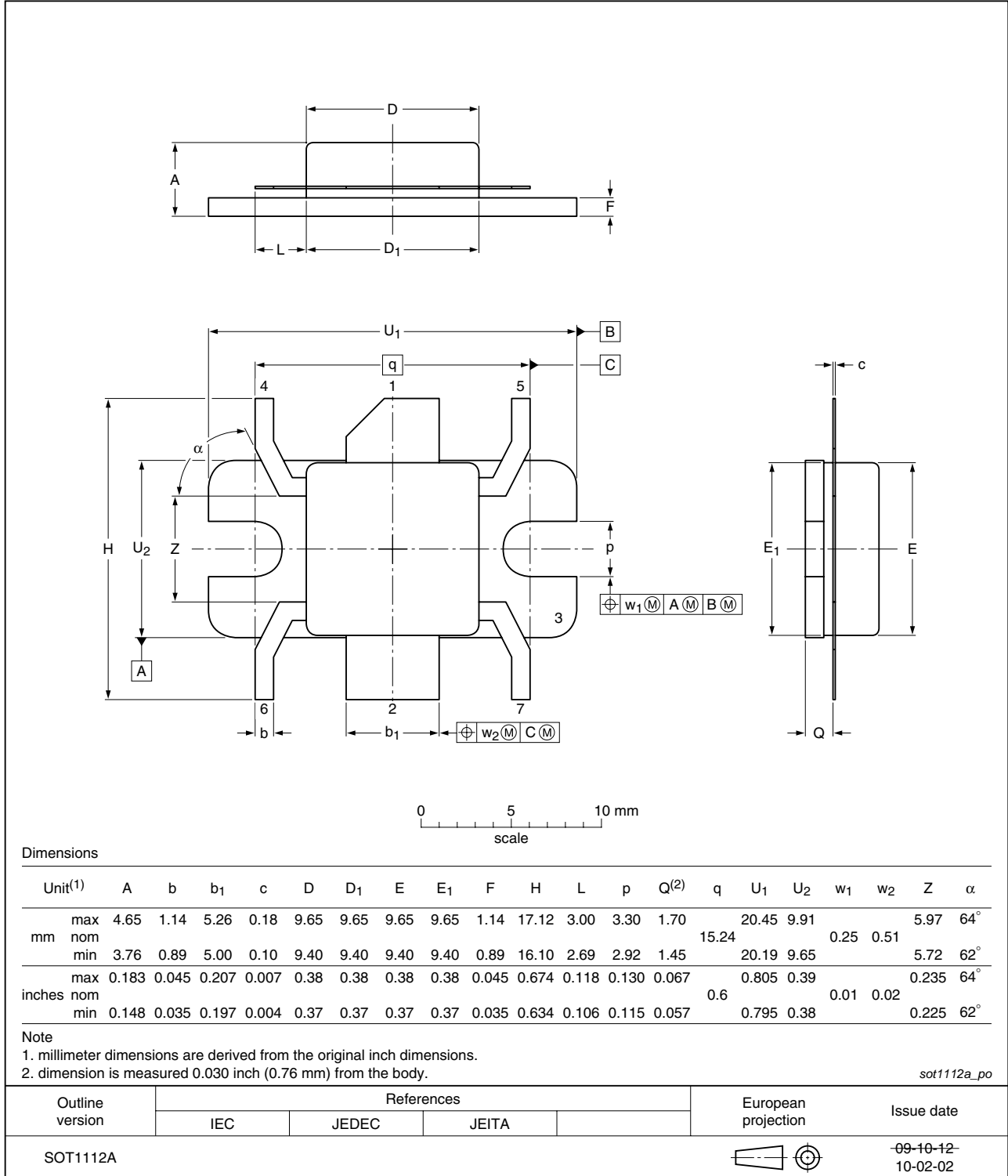

Fig 15. Package outline SOT1112A

Earless flanged ceramic package; 6 leads

SOT1112B

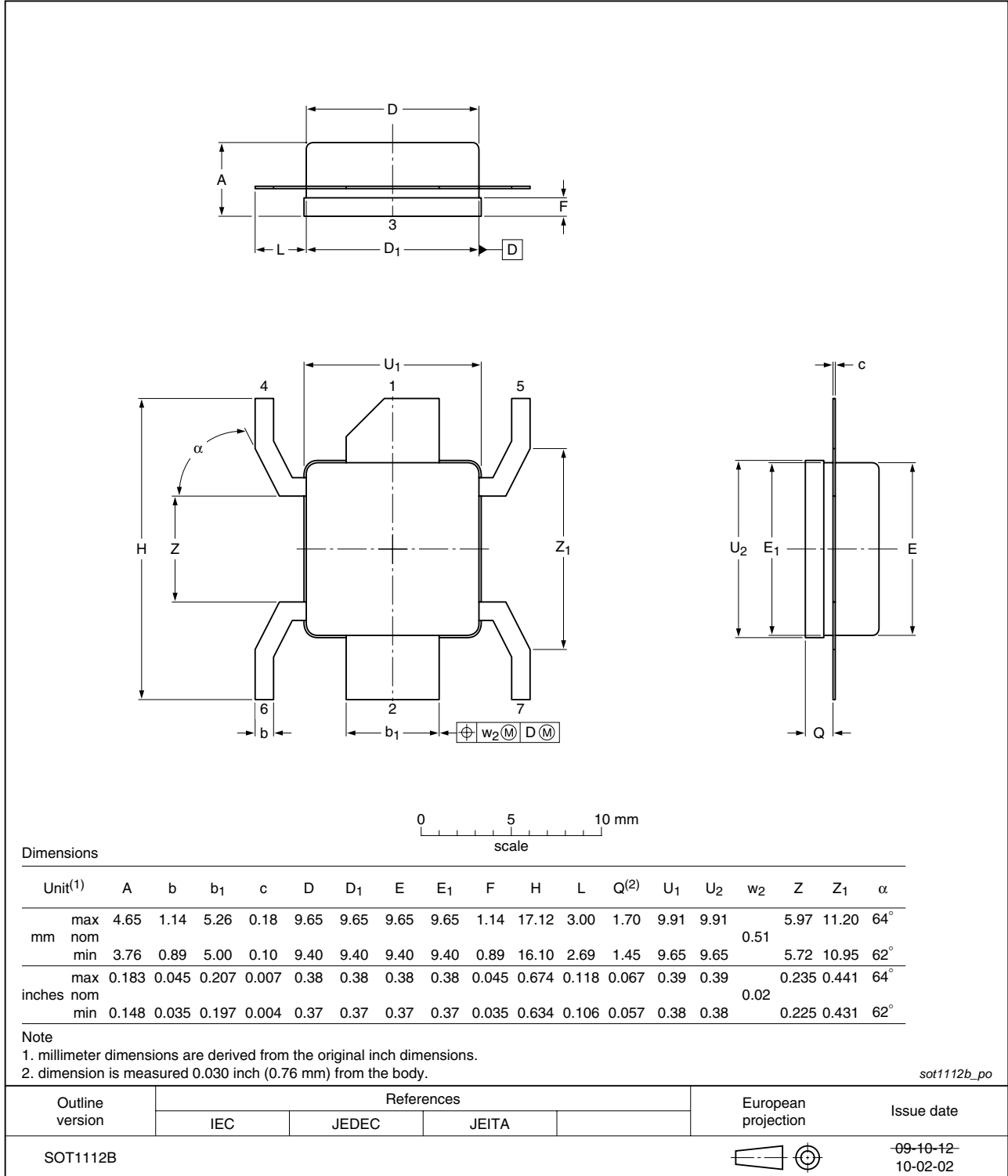

Fig 16. Package outline SOT1112B

9. Handling information

CAUTION



This device is sensitive to ElectroStatic Discharge (ESD). Observe precautions for handling electrostatic sensitive devices.

Such precautions are described in the *ANSI/ESD S20.20*, *IEC/ST 61340-5*, *JESD625-A* or equivalent standards.

10. Abbreviations

Table 9. Abbreviations

Acronym	Description
3GPP	3rd Generation Partnership Project
CCDF	Complementary Cumulative Distribution Function
CW	Continuous Wave
DPCH	Dedicated Physical CHannel
ESD	ElectroStatic Discharge
LDMOS	Laterally Diffused Metal-Oxide Semiconductor
PAR	Peak-to-Average power Ratio
RF	Radio Frequency
VSWR	Voltage Standing-Wave Ratio
W-CDMA	Wideband Code Division Multiple Access

11. Revision history

Table 10. Revision history

Document ID	Release date	Data sheet status	Change notice	Supersedes
BLF6G27L-50BN_6G27LS-50BN v.2	20110407	Product data sheet	-	BLF6G27L-50BN_6G27LS-50BN v.1
Modifications: <ul style="list-style-type: none"> • Section 1.1 on page 1: 45 W has been changed to 50 W. • Table 1 on page 1: several changes have been made. • The ESD warning has been moved to Section 9 on page 12. • Section 1.2 on page 1: the value of efficiency has been changed. • Section 1.3 on page 1: the term W-CDMA has been removed from the sentence. • Table 4 on page 2: the limiting values for I_D have been added. • Table 5 on page 3: The value for $R_{th(j-case)}$ has been changed. • Table 6 on page 3: several changes have been made. • Table 7 on page 3: several changes have been made. • Table 8 on page 4: several changes have been made. • Section 7.1 on page 4: several changes have been made. • Section 7.2 on page 4: section has been added. • Section 7.3 on page 5: section has been added. • Section 7.4 on page 7: section has been added. • Section 7.5 on page 9: section has been added. • Section 9 on page 12: section has been added. 				
BLF6G27L-50BN_6G27LS-50BN v.1	20100916	Objective data sheet	-	-

12. Legal information

12.1 Data sheet status

Document status ^{[1][2]}	Product status ^[3]	Definition
Objective [short] data sheet	Development	This document contains data from the objective specification for product development.
Preliminary [short] data sheet	Qualification	This document contains data from the preliminary specification.
Product [short] data sheet	Production	This document contains the product specification.

[1] Please consult the most recently issued document before initiating or completing a design.

[2] The term 'short data sheet' is explained in section "Definitions".

[3] The product status of device(s) described in this document may have changed since this document was published and may differ in case of multiple devices. The latest product status information is available on the Internet at URL <http://www.nxp.com>.

12.2 Definitions

Draft — The document is a draft version only. The content is still under internal review and subject to formal approval, which may result in modifications or additions. NXP Semiconductors does not give any representations or warranties as to the accuracy or completeness of information included herein and shall have no liability for the consequences of use of such information.

Short data sheet — A short data sheet is an extract from a full data sheet with the same product type number(s) and title. A short data sheet is intended for quick reference only and should not be relied upon to contain detailed and full information. For detailed and full information see the relevant full data sheet, which is available on request via the local NXP Semiconductors sales office. In case of any inconsistency or conflict with the short data sheet, the full data sheet shall prevail.

Product specification — The information and data provided in a Product data sheet shall define the specification of the product as agreed between NXP Semiconductors and its customer, unless NXP Semiconductors and customer have explicitly agreed otherwise in writing. In no event however, shall an agreement be valid in which the NXP Semiconductors product is deemed to offer functions and qualities beyond those described in the Product data sheet.

12.3 Disclaimers

Limited warranty and liability — Information in this document is believed to be accurate and reliable. However, NXP Semiconductors does not give any representations or warranties, expressed or implied, as to the accuracy or completeness of such information and shall have no liability for the consequences of use of such information.

In no event shall NXP Semiconductors be liable for any indirect, incidental, punitive, special or consequential damages (including - without limitation - lost profits, lost savings, business interruption, costs related to the removal or replacement of any products or rework charges) whether or not such damages are based on tort (including negligence), warranty, breach of contract or any other legal theory.

Notwithstanding any damages that customer might incur for any reason whatsoever, NXP Semiconductors' aggregate and cumulative liability towards customer for the products described herein shall be limited in accordance with the *Terms and conditions of commercial sale* of NXP Semiconductors.

Right to make changes — NXP Semiconductors reserves the right to make changes to information published in this document, including without limitation specifications and product descriptions, at any time and without notice. This document supersedes and replaces all information supplied prior to the publication hereof.

Product specification — The information and data provided in a Product data sheet shall define the specification of the product as agreed between NXP Semiconductors and its customer, unless NXP Semiconductors and

customer have explicitly agreed otherwise in writing. In no event however, shall an agreement be valid in which the NXP Semiconductors product is deemed to offer functions and qualities beyond those described in the Product data sheet.

Applications — Applications that are described herein for any of these products are for illustrative purposes only. NXP Semiconductors makes no representation or warranty that such applications will be suitable for the specified use without further testing or modification.

Customers are responsible for the design and operation of their applications and products using NXP Semiconductors products, and NXP Semiconductors accepts no liability for any assistance with applications or customer product design. It is customer's sole responsibility to determine whether the NXP Semiconductors product is suitable and fit for the customer's applications and products planned, as well as for the planned application and use of customer's third party customer(s). Customers should provide appropriate design and operating safeguards to minimize the risks associated with their applications and products.

NXP Semiconductors does not accept any liability related to any default, damage, costs or problem which is based on any weakness or default in the customer's applications or products, or the application or use by customer's third party customer(s). Customer is responsible for doing all necessary testing for the customer's applications and products using NXP Semiconductors products in order to avoid a default of the applications and the products or of the application or use by customer's third party customer(s). NXP does not accept any liability in this respect.

Limiting values — Stress above one or more limiting values (as defined in the Absolute Maximum Ratings System of IEC 60134) will cause permanent damage to the device. Limiting values are stress ratings only and (proper) operation of the device at these or any other conditions above those given in the Recommended operating conditions section (if present) or the Characteristics sections of this document is not warranted. Constant or repeated exposure to limiting values will permanently and irreversibly affect the quality and reliability of the device.

Terms and conditions of commercial sale — NXP Semiconductors products are sold subject to the general terms and conditions of commercial sale, as published at <http://www.nxp.com/profile/terms>, unless otherwise agreed in a valid written individual agreement. In case an individual agreement is concluded only the terms and conditions of the respective agreement shall apply. NXP Semiconductors hereby expressly objects to applying the customer's general terms and conditions with regard to the purchase of NXP Semiconductors products by customer.

No offer to sell or license — Nothing in this document may be interpreted or construed as an offer to sell products that is open for acceptance or the grant, conveyance or implication of any license under any copyrights, patents or other industrial or intellectual property rights.

Export control — This document as well as the item(s) described herein may be subject to export control regulations. Export might require a prior authorization from national authorities.

Non-automotive qualified products — Unless this data sheet expressly states that this specific NXP Semiconductors product is automotive qualified, the product is not suitable for automotive use. It is neither qualified nor tested in accordance with automotive testing or application requirements. NXP Semiconductors accepts no liability for inclusion and/or use of non-automotive qualified products in automotive equipment or applications.

In the event that customer uses the product for design-in and use in automotive applications to automotive specifications and standards, customer (a) shall use the product without NXP Semiconductors' warranty of the product for such automotive applications, use and specifications, and (b) whenever customer uses the product for automotive applications beyond

NXP Semiconductors' specifications such use shall be solely at customer's own risk, and (c) customer fully indemnifies NXP Semiconductors for any liability, damages or failed product claims resulting from customer design and use of the product for automotive applications beyond NXP Semiconductors' standard warranty and NXP Semiconductors' product specifications.

12.4 Trademarks

Notice: All referenced brands, product names, service names and trademarks are the property of their respective owners.

13. Contact information

For more information, please visit: <http://www.nxp.com>

For sales office addresses, please send an email to: salesaddresses@nxp.com

14. Contents

1 Product profile 1

1.1 General description 1

1.2 Features and benefits 1

1.3 Applications 1

2 Pinning information 2

3 Ordering information 2

4 Limiting values 2

5 Thermal characteristics 3

6 Characteristics 3

7 Application information 3

7.1 Ruggedness in Class-AB operation 4

7.2 Single carrier IS-95 4

7.3 Pulsed CW 5

7.4 2-carrier W-CDMA 7

7.5 Single carrier W-CDMA 9

8 Package outline 10

9 Handling information 12

10 Abbreviations 12

11 Revision history 13

12 Legal information 14

12.1 Data sheet status 14

12.2 Definitions 14

12.3 Disclaimers 14

12.4 Trademarks 15

13 Contact information 15

14 Contents 16

Please be aware that important notices concerning this document and the product(s) described herein, have been included in section 'Legal information'.

© NXP B.V. 2011. All rights reserved.

For more information, please visit: <http://www.nxp.com>
 For sales office addresses, please send an email to: salesaddresses@nxp.com

Date of release: 7 April 2011
 Document identifier: BLF6G27L-50BN_6G27LS-50BN