

1/34, 1/36 DUTY LCD CONTROLLER/DRIVER

The μ PD16675A is a driver containing a RAM capable of full-dot LCD display. A single μ PD16675A IC chip can operate a full-dot (up to 128-by-32 dots) LCD and two-line (upper & lower) pictograph display.

This IC is ideal for Kanji character or Chinese character pagers, displaying 16-by-16 dots per character.

FEATURES

- LCD driver with built-in display RAM
- Can operate on a single 3-V power supply
- Booster circuit incorporated: Switchable between 2X & 3X
- Dot display RAM: 128 \times 32 bits
- Pictographic display RAM (portion of two lines): 128 \times 2 bits
- Pictographic display RAM duty changeable: 1/34 and 2/36 duties
- Output: 128 segments & 34 commons
- Data input based on serial & 4-/8-bit parallel switchover
- Split resistor incorporated
- Oscillation circuit incorporated

ORDERING INFORMATION

Part Number	Package
μ PD16675AP/W	Chips/wafer (Matched COG mounting)
μ PD16675AN-051	2-side standard TCP (Output OLB: 0.25 mm pitch)
μ PD16675AN-xxx	TCP (TAB)

Purchasing the above products in terms of chips per wafer requires an exchange of other documents as well, including a memorandum on the product quality. Therefore, those who are interested in this regard are advised to contact an NEC sales representative for further details.

The information in this document is subject to change without notice.

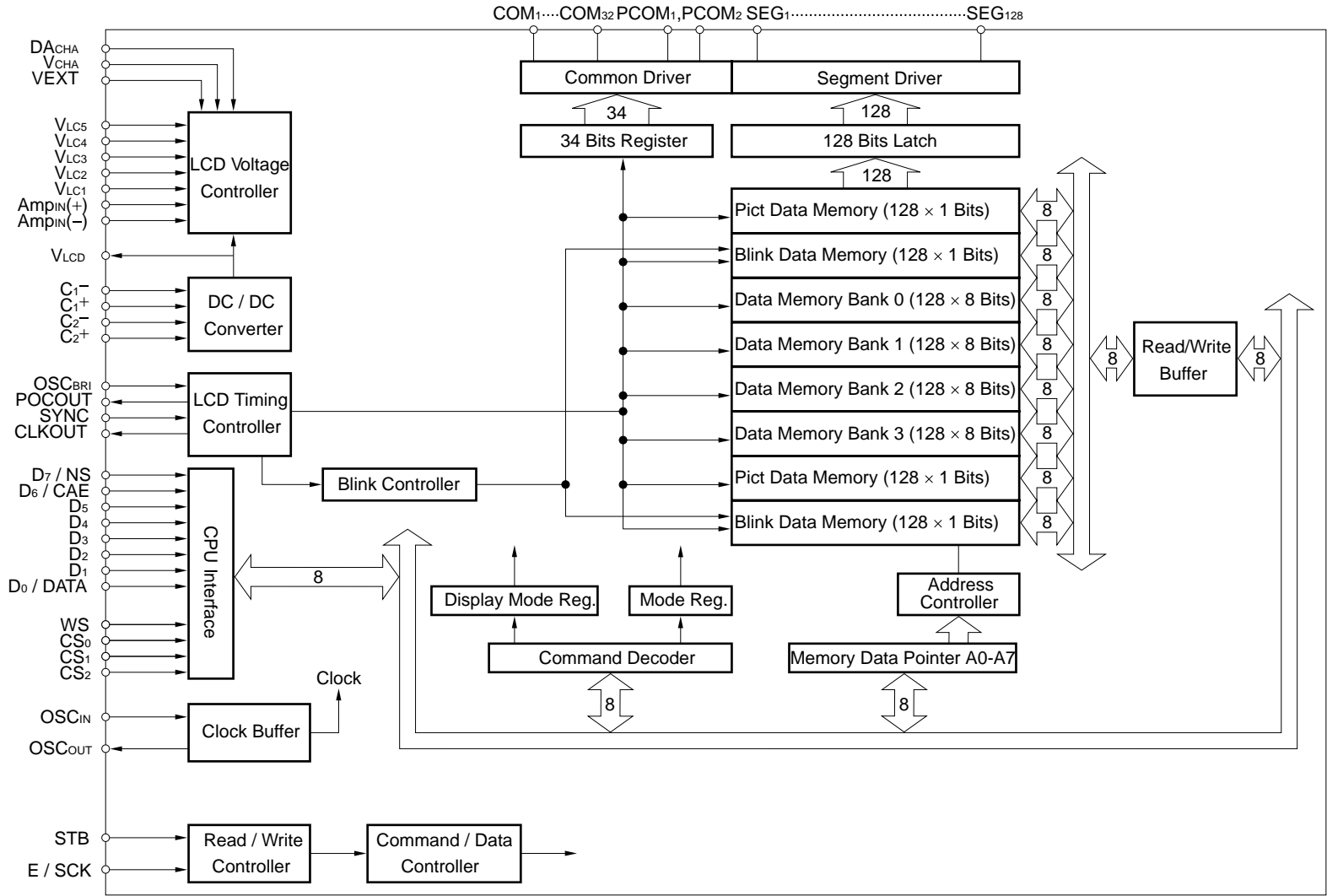

BLOCK DIAGRAM

PIN CONFIGURATION (PAD LAYOUT)

(Chip size: 12.68 × 1.81 mm²)

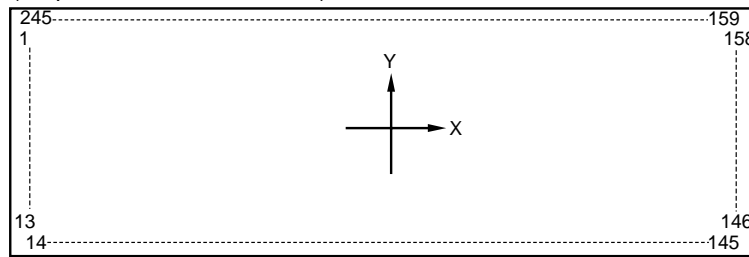

No.	PIN	X (μm)	Y (μm)
1	DUMMY	-6094.8	516.6
2	DUMMY	-6094.8	426.6
3	COM ₂₂	-6094.8	336.6
4	COM ₂₁	-6094.8	246.6
5	COM ₂₀	-6094.8	156.6
6	COM ₁₉	-6094.8	66.6
7	COM ₁₈	-6094.8	-23.4
8	COM ₁₇	-6094.8	-113.4
9	DUMMY	-6094.8	-203.4
10	DUMMY	-6094.8	-293.4
11	DUMMY	-6094.8	-383.4
12	DUMMY	-6094.8	-473.4
13	DUMMY	-6094.8	-563.4
14	DUMMY	-5893.8	-661.6
15	DUMMY	-5803.8	-661.6
16	SEG ₁₂₈	-5713.8	-661.6
17	SEG ₁₂₇	-5623.8	-661.6
18	SEG ₁₂₆	-5533.8	-661.6
19	SEG ₁₂₅	-5443.8	-661.6
20	SEG ₁₂₄	-5353.8	-661.6
21	SEG ₁₂₃	-5263.8	-661.6
22	SEG ₁₂₂	-5173.8	-661.6
23	SEG ₁₂₁	-5083.8	-661.6
24	SEG ₁₂₀	-4993.8	-661.6
25	SEG ₁₁₉	-4903.8	-661.6
26	SEG ₁₁₈	-4813.8	-661.6
27	SEG ₁₁₇	-4723.8	-661.6
28	SEG ₁₁₆	-4633.8	-661.6
29	SEG ₁₁₅	-4543.8	-661.6
30	SEG ₁₁₄	-4453.8	-661.6
31	SEG ₁₁₃	-4363.8	-661.6
32	SEG ₁₁₂	-4273.8	-661.6
33	SEG ₁₁₁	-4183.8	-661.6
34	SEG ₁₁₀	-4093.8	-661.6
35	SEG ₁₀₉	-4003.8	-661.6
36	SEG ₁₀₈	-3913.8	-661.6
37	SEG ₁₀₇	-3823.8	-661.6
38	SEG ₁₀₆	-3733.8	-661.6
39	SEG ₁₀₅	-3643.8	-661.6
40	SEG ₁₀₄	-3553.8	-661.6
41	SEG ₁₀₃	-3463.8	-661.6
42	SEG ₁₀₂	-3373.8	-661.6
43	SEG ₁₀₁	-3283.8	-661.6
44	SEG ₁₀₀	-3193.8	-661.6
45	SEG ₉₉	-3103.8	-661.6
46	SEG ₉₈	-3013.8	-661.6
47	SEG ₉₇	-2923.8	-661.6
48	SEG ₉₆	-2833.8	-661.6
49	SEG ₉₅	-2743.8	-661.6
50	SEG ₉₄	-2653.8	-661.6
51	SEG ₉₃	-2563.8	-661.6
52	SEG ₉₂	-2473.8	-661.6
53	SEG ₉₁	-2383.8	-661.6
54	SEG ₉₀	-2293.8	-661.6
55	SEG ₈₉	-2203.8	-661.6
56	SEG ₈₈	-2113.8	-661.6
57	SEG ₈₇	-2023.8	-661.6
58	SEG ₈₆	-1933.8	-661.6
59	SEG ₈₅	-1843.8	-661.6
60	SEG ₈₄	-1753.8	-661.6
61	SEG ₈₃	-1663.8	-661.6
62	SEG ₈₂	-1573.8	-661.6
63	SEG ₈₁	-1483.8	-661.6

No.	PIN	X (μm)	Y (μm)
64	SEG ₈₀	-1393.8	-661.6
65	SEG ₇₉	-1303.8	-661.6
66	SEG ₇₈	-1213.8	-661.6
67	SEG ₇₇	-1123.8	-661.6
68	SEG ₇₆	-1033.8	-661.6
69	SEG ₇₅	-943.8	-661.6
70	SEG ₇₄	-853.8	-661.6
71	SEG ₇₃	-763.8	-661.6
72	SEG ₇₂	-673.8	-661.6
73	SEG ₇₁	-583.8	-661.6
74	SEG ₇₀	-493.8	-661.6
75	SEG ₆₉	-403.8	-661.6
76	SEG ₆₈	-313.8	-661.6
77	SEG ₆₇	-223.8	-661.6
78	SEG ₆₆	-133.8	-661.6
79	SEG ₆₅	-43.8	-661.6
80	SEG ₆₄	46.2	-661.6
81	SEG ₆₃	136.2	-661.6
82	SEG ₆₂	226.2	-661.6
83	SEG ₆₁	316.2	-661.6
84	SEG ₆₀	406.2	-661.6
85	SEG ₅₉	496.2	-661.6
86	SEG ₅₈	586.2	-661.6
87	SEG ₅₇	676.2	-661.6
88	SEG ₅₆	766.2	-661.6
89	SEG ₅₅	856.2	-661.6
90	SEG ₅₄	946.2	-661.6
91	SEG ₅₃	1036.2	-661.6
92	SEG ₅₂	1126.2	-661.6
93	SEG ₅₁	1216.2	-661.6
94	SEG ₅₀	1306.2	-661.6
95	SEG ₄₉	1396.2	-661.6
96	SEG ₄₈	1486.2	-661.6
97	SEG ₄₇	1576.2	-661.6
98	SEG ₄₆	1666.2	-661.6
99	SEG ₄₅	1756.2	-661.6
100	SEG ₄₄	1846.2	-661.6
101	SEG ₄₃	1936.2	-661.6
102	SEG ₄₂	2026.2	-661.6
103	SEG ₄₁	2116.2	-661.6
104	SEG ₄₀	2206.2	-661.6
105	SEG ₃₉	2296.2	-661.6
106	SEG ₃₈	2386.2	-661.6
107	SEG ₃₇	2476.2	-661.6
108	SEG ₃₆	2566.2	-661.6
109	SEG ₃₅	2656.2	-661.6
110	SEG ₃₄	2746.2	-661.6
111	SEG ₃₃	2836.2	-661.6
112	SEG ₃₂	2926.2	-661.6
113	SEG ₃₁	3016.2	-661.6
114	SEG ₃₀	3106.2	-661.6
115	SEG ₂₉	3196.2	-661.6
116	SEG ₂₈	3286.2	-661.6
117	SEG ₂₇	3376.2	-661.6
118	SEG ₂₆	3466.2	-661.6
119	SEG ₂₅	3556.2	-661.6
120	SEG ₂₄	3646.2	-661.6
121	SEG ₂₃	3736.2	-661.6
122	SEG ₂₂	3826.2	-661.6
123	SEG ₂₁	3916.2	-661.6
124	SEG ₂₀	4006.2	-661.6
125	SEG ₁₉	4096.2	-661.6
126	SEG ₁₈	4186.2	-661.6

No.	PIN	X (μm)	Y (μm)
127	SEG ₁₇	4276.2	-661.6
128	SEG ₁₆	4366.2	-661.6
129	SEG ₁₅	4456.2	-661.6
130	SEG ₁₄	4546.2	-661.6
131	SEG ₁₃	4636.2	-661.6
132	SEG ₁₂	4726.2	-661.6
133	SEG ₁₁	4816.2	-661.6
134	SEG ₁₀	4906.2	-661.6
135	SEG ₉	4996.2	-661.6
136	SEG ₈	5086.2	-661.6
137	SEG ₇	5176.2	-661.6
138	SEG ₆	5266.2	-661.6
139	SEG ₅	5356.2	-661.6
140	SEG ₄	5446.2	-661.6
141	SEG ₃	5536.2	-661.6
142	SEG ₂	5626.2	-661.6
143	SEG ₁	5716.2	-661.6
144	DUMMY	5806.2	-661.6
145	DUMMY	5896.2	-661.6
146	DUMMY	6094.8	-563.4
147	DUMMY	6094.8	-473.4
148	DUMMY	6094.8	-383.4
149	DUMMY	6094.8	-293.4
150	DUMMY	6094.8	-203.4
151	PCOM ₁	6094.8	-113.4
152	COM ₁	6094.8	-23.4
153	COM ₂	6094.8	66.6
154	COM ₃	6094.8	156.6
155	COM ₄	6094.8	246.6
156	COM ₅	6094.8	336.6
157	DUMMY	6094.8	426.6
158	DUMMY	6094.8	516.6
159	DUMMY	5870.6	760
160	DUMMY	5780.6	760
161	DUMMY	5690.6	760
162	DUMMY	5600.6	760
163	COM ₆	5510.6	760
164	COM ₇	5420.6	760
165	COM ₈	5330.6	760
166	COM ₉	5240.6	760
167	COM ₁₀	5150.6	760
168	COM ₁₁	5060.6	760
169	COM ₁₂	4970.6	760
170	COM ₁₃	4880.6	760
171	COM ₁₄	4790.6	760
172	COM ₁₅	4700.6	760
173	COM ₁₆	4610.6	760
174	DUMMY	4520.6	760
175	V _{LC5}	4400.8	760
176	V _{LC4}	4224.8	760
177	V _{LC3}	4048.8	760
178	V _{LC2}	3872.8	760
179	V _{LC1}	3696.8	760
180	V _{LCD}	3520.8	760
181	V _{LCD}	3344.8	760
182	Amp _{IN(-)}	3168.8	760
183	Amp _{IN(+)}	2992.8	760
184	Amp _{OUT}	2816.8	760
185	C ₁₋	2640.8	760
186	C ₁₋	2550.8	760
187	C ₁₋	2460.8	760
188	C ₁₊	2284.8	760
189	C ₁₊	2194.8	760

No.	PIN	X (μm)	Y (μm)
190	C ₁₊	2104.8	760
191	C ₂₋	1928.8	760
192	C ₂₋	1838.8	760
193	C ₂₋	1748.8	760
194	C ₂₊	1572.8	760
195	C ₂₊	1482.8	760
196	C ₂₊	1392.8	760
197	V _{DD2}	1232.8	760
198	VEXT	1056.8	760
199	OSC _{BRI}	880.8	760
200	OSC _{IN}	704.8	760
201	OSC _{OUT}	528.8	760
202	D _A CHA	352.8	760
203	V _{DD1}	176.8	760
204	V _{DD1}	0.8	760
205	V _{CHA}	-175.2	760
206	V _{SS}	-351.2	760
207	CS ₀	-527.2	760
208	CS ₁	-703.2	760
209	CS ₂	-879.2	760
210	RESET	-1055.2	760
211	D ₇ /NS	-1231.2	760
212	D ₆ /CAE	-1407.2	760
213	D ₅	-1583.2	760
214	D ₄	-1759.2	760
215	D ₃	-1935.2	760
216	D ₂	-2111.2	760
217	D ₁	-2287.2	760
218	D ₀ /DATA	-2463.2	760
219	E/SCK	-2639.2	760
220	STB	-2815.2	760
221	V _{SS}	-2991.2	760
222	V _{SS}	-3167.2	760
223	WS	-3343.2	760
224	V _{DD1}	-3519.2	760
225	POCOUT	-3695.2	760
226	CLKOUT	-3871.2	760
227	SYNC	-4047.2	760
228	V _{EE}	-4223.2	760
229	V _{EE}	-4399.2	760
230	DUMMY	-4520.6	760
231	PCOM ₂	-4610.6	760
232	COM ₃₂	-4700.6	760
233	COM ₃₁	-4790.6	760
234	COM ₃₀	-4880.6	760
235	COM ₂₉	-4970.6	760
236	COM ₂₈	-5060.6	760
237	COM ₂₇	-5150.6	760
238	COM ₂₆	-5240.6	760
239	COM ₂₅	-5330.6	760
240	COM ₂₄	-5420.6	760
241	COM ₂₃	-5510.6	760
242	DUMMY	-5600.6	760
243	DUMMY	-5690.6	760
244	DUMMY	-5780.6	760
245	DUMMY	-5870.6	760

CONTENTS

1. PIN FUNCTIONS	6
1.1 Power System.....	6
1.2 Logic System.....	6
1.3 Driver System	8
2. VOLTAGE CONTROL CIRCUIT	8
3. LCD DISPLAY	9
4. GROUP ADDRESSES	10
4.1 Dot Display	10
4.2 Pictographic Display.....	11
4.3 Blink Data.....	12
5. COMMAND	13
5.1 Basic Form.....	13
5.2 Chip Address Register (CAR)	13
5.3 Command Register	14
5.3.1 Reset	14
5.3.2 Display ON/OFF	14
5.3.3 Standby	14
5.3.4 Duty setting.....	15
5.3.5 Master/slave setting.....	15
5.3.6 Blink setting	15
5.3.7 Data R/W mode	16
5.3.8 Test mode.....	16
5.3.9 D/A converter setting.....	16
5.4 Address Register	17
6. RESETTING	18
7. COMMUNICATION FORMAT	19
7.1 Serial	19
7.1.1 Reception 1 (Command/data write: 1 byte)	19
7.1.2 Reception 2 (Command/data write: 2 bytes or more)	19
7.1.3 Transmission (Command/data read)	19
7.2 Parallel	20
7.2.1 8-bit parallel interface	20
7.2.2 4-bit parallel interface	20
8. CPU ACCESS EXAMPLES	21
8.1 Initialize and Data Write.....	21
8.2 Change Display Data and Pictographic Data (All Data are Changed)	23
8.3 Read Display Data and Pictograph Data	24
8.4 Blink Data Setting	25
9. ELECTRICAL CHARACTERISTICS	26

10. PACKAGE DRAWING32

1. PIN FUNCTIONS

1.1 Power System

Pin Symbol	Pin Name	Pin No.	I/O	Description
V _{DD1}	Logic power supply pin	203, 204, 224	---	Power supply pin for logic
V _{DD2}	Power supply pin for booster circuit	197	---	Power supply pin for booster circuit. Set the pin to $V_{DD1} \leq V_{DD2}$.
V _{SS}	Logic ground pin	206, 221, 222	---	Ground pin for logic
V _{LCD}	Driver power supply pin	180, 181	---	Driver power supply pin. Output pin of internal booster circuit. Connect with a 1-μF booster capacitor to the V _{DD2} pin. When not using the internal booster circuit, the driver power can be turned on directly.
V _{LC1} to V _{LC5}	Driver reference power supply	179 to 175	---	Reference power supply pin for LCD drive. When the internal bias is selected, be sure to leave it open.
C ₁ ⁺ , C ₁ ⁻ , C ₂ ⁺ , C ₂ ⁻	Capacitor connection pins	185 to 196	---	Capacitor connection pins for booster circuit. Connect a 1 μF capacitor.
V _{EE}	Driver ground pin	228, 229	---	Ground pin for driver

1.2 Logic System

Pin Symbol	Pin Name	Pin No.	I/O	Description
WS	Word length selection	223	I	This pin selects the word length. At High level, it becomes an 8-bit parallel interface. At Low level, it becomes a 4-bit parallel interface if D ₇ /NS is High; and a serial interface if D ₇ /NS is Low. When the word length is 4 bits, data is transferred in the upper-to-lower sequence by means of data buses D ₀ to D ₃ . The word length cannot be changed after power-on.
STB	Strobe	220	I	Data can be input/output at Low level either in parallel interface or serial interface mode.
E/SCK	Enable/shift clock	219	I	In parallel interface mode, this becomes the data enable input pin. During read-in, data is fetched into the interface buffer at the rising edge. During read-out, data is fetched from the interface buffer at the falling edge. In serial interface mode, this pin becomes the data shift clock. During read-in, data is fetched into the shift register at the rising edge. During read-out, data is fetched from the shift register at the falling edge.
CLKOUT	Clock for slave IC output	226	O	This pin outputs an inverted oscillation clock. It connects to slave IC's OSC _{IN} directly.
POCOUT	Power-on reset monitor	225	O	Monitor pin for internal power-on reset. At Low level, power-on reset is set internally. At High level, power-on reset is released. The pin is for IC testing. Normally leave it open.

1.2 Logic System (Continued)

Pin Symbol	Pin Name	Pin No.	I/O	Description
D ₀ /DATA	Data bus/data	218	I/O	In parallel interface mode, this pin becomes the D ₀ bit of the data bus. In serial interface mode, it becomes the input/output pin of the command and display data (3 states).
D ₁ to D ₅	Data bus	217 to 213	I/O	In parallel interface mode, these pins become the D ₁ to D ₅ bits of the data bus. In serial interface mode, leave them open.
D ₆ /CAE	Data bus/chip address enable	212	I/O	In 8-bit parallel interface mode, this pin becomes the D ₆ bit of the data bus. In 4-bit parallel interface and serial interface modes, it becomes chip address enable. Also, at High level, it becomes chip address valid; at Low level, chip address invalid. In 8-bit parallel interface, it becomes chip address valid.
D ₇ /NS	Data bus/nibble select	211	I/O	When the word select (WS) is High level, this bit becomes the D ₇ bit of the data bus. When WS is Low level, it becomes the nibble select (NS). When NS is High level, it becomes 4-bit parallel interface. When NS is Low level, it becomes serial interface. In 4-bit parallel interface mode, data cannot be read out.
RESET	Reset	210	I	At Low level, internal initialization is performed.
V _{CHA}	Boosting magnitude switching	205	I	The boosting magnitude of the internal booster circuit is switched over. At High level, it is switched to 3X, while, at Low level, 2X.
DA _{CHA}	D/A converter switching	202	I	Select whether to use the internal D/A converter for temperature correction or not. At High level, this circuit is used, at Low level, unused.
VEXT	Reference supply switching	198	I	Selects the method for supplying the reference power circuit. At High level, the circuit is supplied externally; and, at Low level, internally.
SYNC	Synchronization	227	I/O	Input/output pin for synchronization. Master mode: Output Slave mode: Input
CS ₀ to CS ₂	Chip select	207 to 209	I	When used for multiple chips, these pins are used to specify their addresses. They can be accessed only when coinciding with b2 to b4 bits of the interface control register.
OSC _{IN}	Oscillation pin	200	I	These pins are connected with the 1 MΩ resistor. When using external oscillation, input it into the OSC _{IN} , leaving the OSC _{OUT} open.
OSC _{OUT}		201	O	
OSC _{BR1}	External clock for blinks	199	I	Input pin of the 2-Hz external clock. It internally divides this clock by 2 to generate 1 Hz and make it the synchronizing signal for blinks.

1.3 Driver System

Pin Symbol	Pin Name	Pin No.	I/O	Description
SEG ₁ to SEG ₁₂₈	Segment	143 to 16	O	Segment output pins
COM ₁ to COM ₃₂	Commons	3 to 8, 152 to 156, 163 to 173, 232 to 241	O	Common output pins
PCOM ₁ , PCOM ₂	Pictographic commons	151, 231	O	Common output pins for pictograph
Amp _{IN} (+), Amp _{IN} (-)	Operational amplifier input	183, 182	I	These are the input pins of the operational amplifier for LCD drive voltage adjustment. Leave Amp _{IN} (+) open when using the internal D/A converter. When not using the D/A converter, it is necessary to input the reference voltage. Connect Amp _{IN} (-) to the LCD voltage adjustment resistor (see the diagram below).
Amp _{OUT}	Operational amplifier output	184	O	This is the input pin of the operational amplifier for LCD drive voltage adjustment. It is normal to connect this pin to the LCD voltage adjustment resistor (see the diagram below). It is recommended to connect approx. 0.1 to 1 μF capacitor to this pin to stabilize the internal amplifier's output.

2. VOLTAGE CONTROL CIRCUIT EXAMPLE

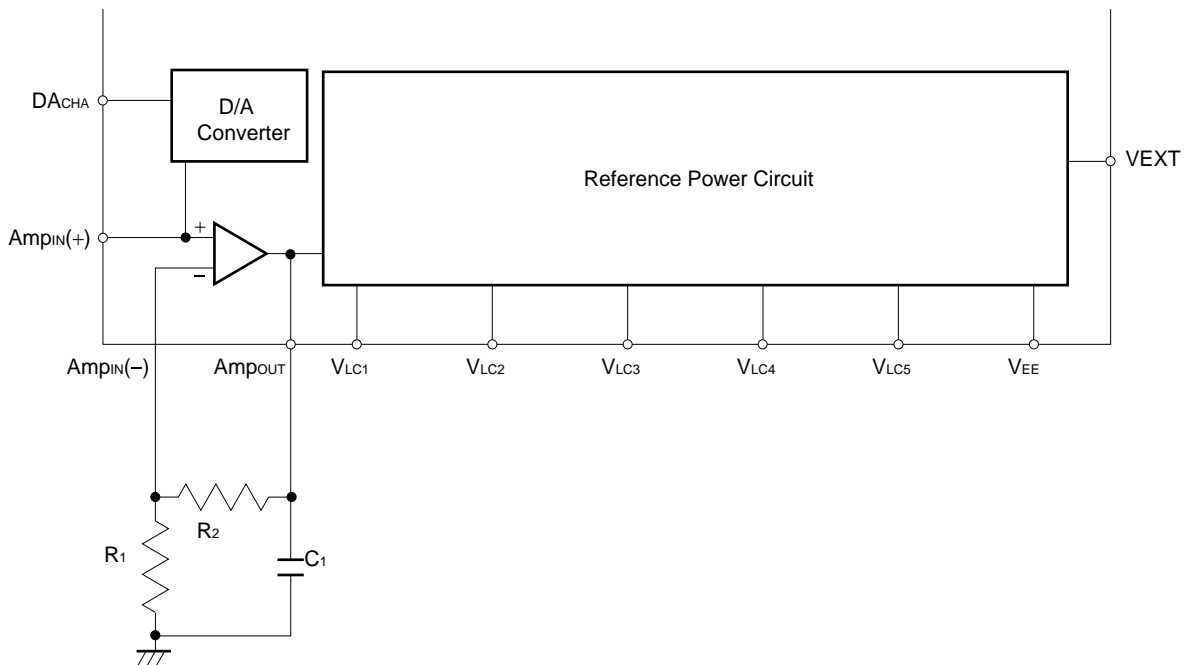

3. LCD DISPLAY

The μPD16675A's LCD can display 128 by 32 dots (called full-dot display) as well as 128 by 2 pictographs on a single screen.

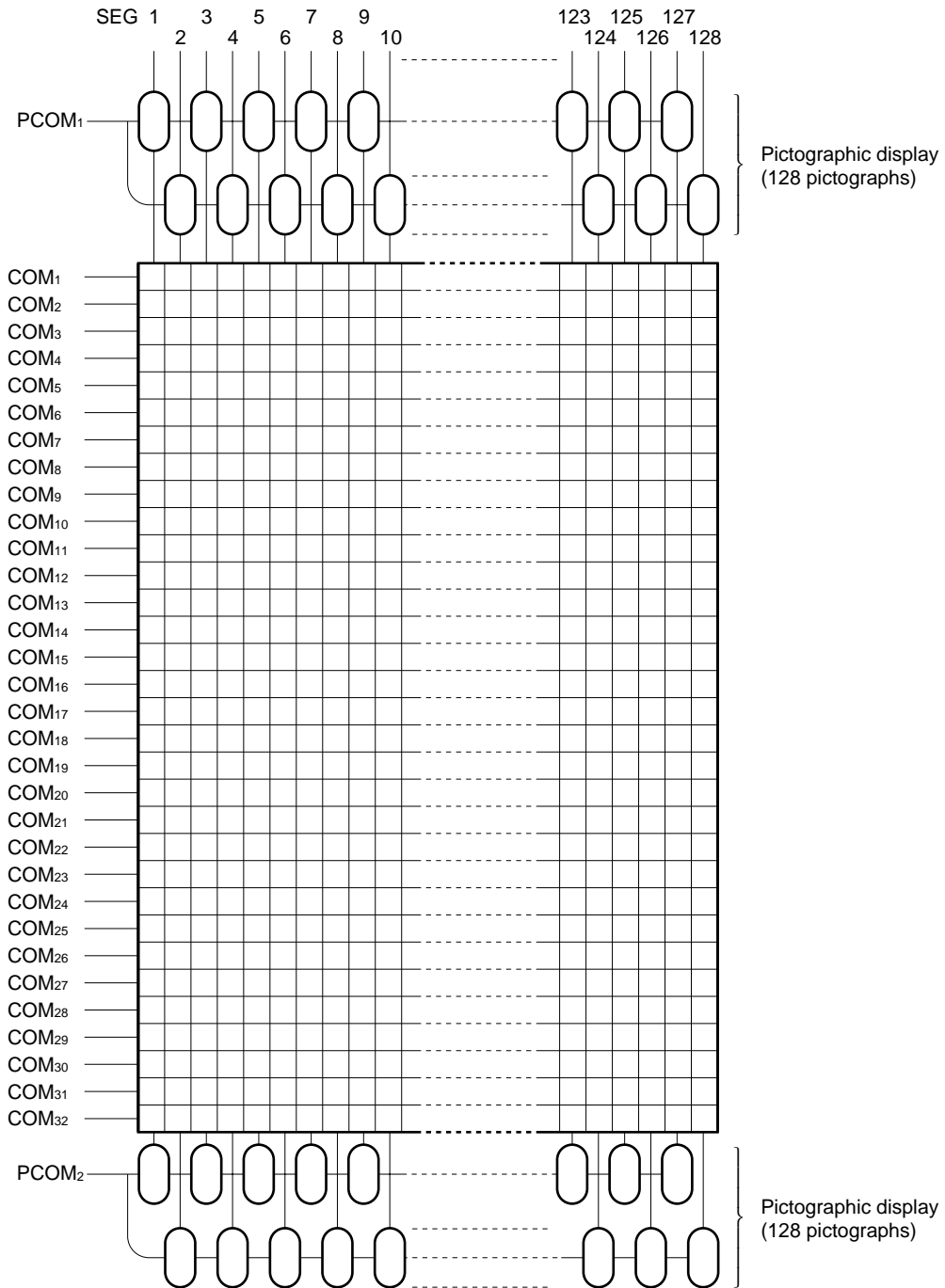

4. GROUP ADDRESSES

4.1 Dot Display

The group addresses of dot display are assigned as follows.

If address increment is set, when the X address goes to 7FH, the next address is 00H. At this time, the Y address changes to the next address. Also, when the Y address goes to 03H, the next address is 00H.

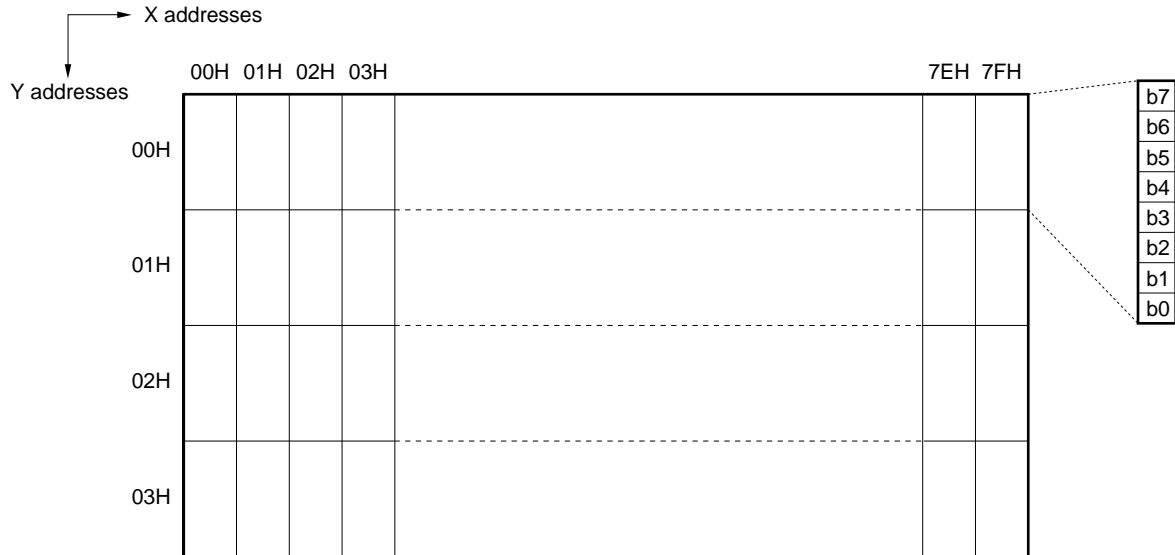

4.2 Pictographic Display

The group addresses of pictograph display are assigned as follows.

If address increment is set, when the X address goes to 0FH, the next address is 00H. At this time, the Y address changes to the next address. Also, when the Y address goes to 01H, the next address is 00H.

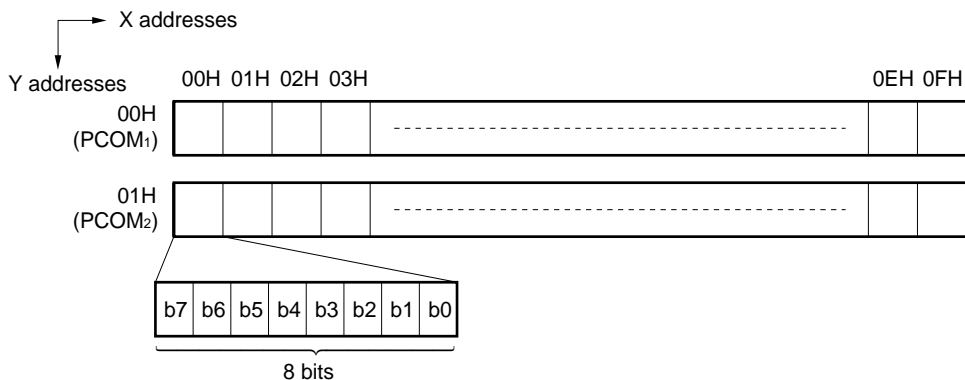

(1) PCOM₁ (Y Address = 00H)

X address	Segment output No.							
	b7	b6	b5	b4	b3	b2	b1	b0
00H	1	2	3	4	5	6	7	8
01H	9	10	11	12	13	14	15	16
02H	17	18	19	20	21	22	23	24
03H	25	26	27	28	29	30	31	32
04H	33	34	35	36	37	38	39	40
05H	41	42	43	44	45	46	47	48
06H	49	50	51	52	53	54	55	56
07H	57	58	59	60	61	62	63	64
08H	65	66	67	68	69	70	71	72
09H	73	74	75	76	77	78	79	80
0AH	81	82	83	84	85	86	87	88
0BH	89	90	91	92	93	94	95	96
0CH	97	98	99	100	101	102	103	104
0DH	105	106	107	108	109	110	111	112
0EH	113	114	115	116	117	118	119	120
0FH	121	122	123	124	125	126	127	128

(2) PCOM₂ (Y Address = 01H)

X address	Segment output No.							
	b7	b6	b5	b4	b3	b2	b1	b0
00H	1	2	3	4	5	6	7	8
01H	9	10	11	12	13	14	15	16
02H	17	18	19	20	21	22	23	24
03H	25	26	27	28	29	30	31	32
04H	33	34	35	36	37	38	39	40
05H	41	42	43	44	45	46	47	48
06H	49	50	51	52	53	54	55	56
07H	57	58	59	60	61	62	63	64
08H	65	66	67	68	69	70	71	72
09H	73	74	75	76	77	78	79	80
0AH	81	82	83	84	85	86	87	88
0BH	89	90	91	92	93	94	95	96
0CH	97	98	99	100	101	102	103	104
0DH	105	106	107	108	109	110	111	112
0EH	113	114	115	116	117	118	119	120
0FH	121	122	123	124	125	126	127	128

4.3 Blink Data

The group addresses of pictographic blink data are assigned as follows.

Write "1" in the address of the pictographic to be blinked.

If address increment is set, when the X address goes to 0FH, the next address is 00H. At this time, the Y address changes to the next address. Also, when the Y address goes to 01H, the next address is 00H.

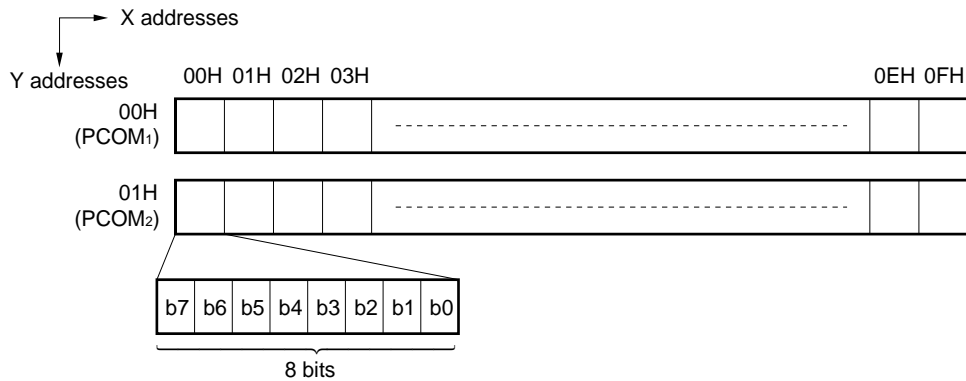

(1) PCOM₁ (Y Address = 00H)

X address	Segment output No.							
	b7	b6	b5	b4	b3	b2	b1	b0
00H	1	2	3	4	5	6	7	8
01H	9	10	11	12	13	14	15	16
02H	17	18	19	20	21	22	23	24
03H	25	26	27	28	29	30	31	32
04H	33	34	35	36	37	38	39	40
05H	41	42	43	44	45	46	47	48
06H	49	50	51	52	53	54	55	56
07H	57	58	59	60	61	62	63	64
08H	65	66	67	68	69	70	71	72
09H	73	74	75	76	77	78	79	80
0AH	81	82	83	84	85	86	87	88
0BH	89	90	91	92	93	94	95	96
0CH	97	98	99	100	101	102	103	104
0DH	105	106	107	108	109	110	111	112
0EH	113	114	115	116	117	118	119	120
0FH	121	122	123	124	125	126	127	128

(2) PCOM₂ (Y Address = 01H)

X address	Segment output No.							
	b7	b6	b5	b4	b3	b2	b1	b0
00H	1	2	3	4	5	6	7	8
01H	9	10	11	12	13	14	15	16
02H	17	18	19	20	21	22	23	24
03H	25	26	27	28	29	30	31	32
04H	33	34	35	36	37	38	39	40
05H	41	42	43	44	45	46	47	48
06H	49	50	51	52	53	54	55	56
07H	57	58	59	60	61	62	63	64
08H	65	66	67	68	69	70	71	72
09H	73	74	75	76	77	78	79	80
0AH	81	82	83	84	85	86	87	88
0BH	89	90	91	92	93	94	95	96
0CH	97	98	99	100	101	102	103	104
0DH	105	106	107	108	109	110	111	112
0EH	113	114	115	116	117	118	119	120
0FH	121	122	123	124	125	126	127	128

5. COMMAND

5.1 Basic Form

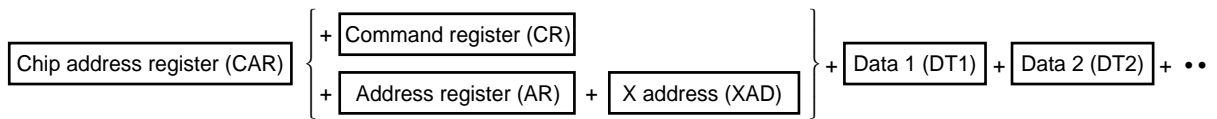

5.2 Chip Address Register (CAR)

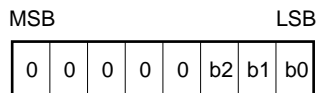

Chip address

- 000: CS₂ = 0, CS₁ = 0, and CS₀ = 0 ICs accessible
- 001: CS₂ = 0, CS₁ = 0, and CS₀ = 1 ICs accessible
- 010: CS₂ = 0, CS₁ = 1, and CS₀ = 0 ICs accessible
- 011: CS₂ = 0, CS₁ = 1, and CS₀ = 1 ICs accessible
- 100: CS₂ = 1, CS₁ = 0, and CS₀ = 0 ICs accessible
- 101: CS₂ = 1, CS₁ = 0, and CS₀ = 1 ICs accessible
- 110: CS₂ = 1, CS₁ = 1, and CS₀ = 0 ICs accessible
- 111: CS₂ = 1, CS₁ = 1, and CS₀ = 1 ICs accessible

The register is made valid in the following states.

Interface	CAE	
	High level	Low level
Serial	Valid	Invalid
4-bit parallel	Valid	Invalid
8-bit parallel	Valid (CAE: Used as the D ₆ bit)	

It is unnecessary to transmit the register that is invalid.

5.3 Command Register

The command register's basic configuration is as follows.

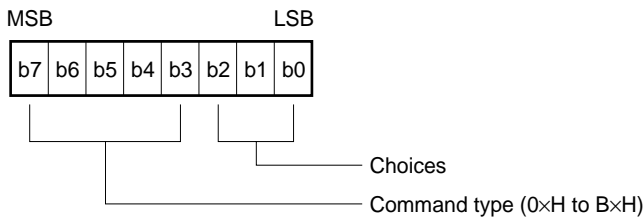

5.3.1 Reset

All the IC's commands are initialized. Resetting takes effect only during the internally predetermined time (one shot).

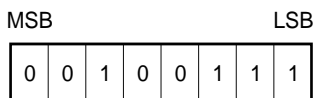

5.3.2 Display ON/OFF

ON/OFF of the display is controlled.

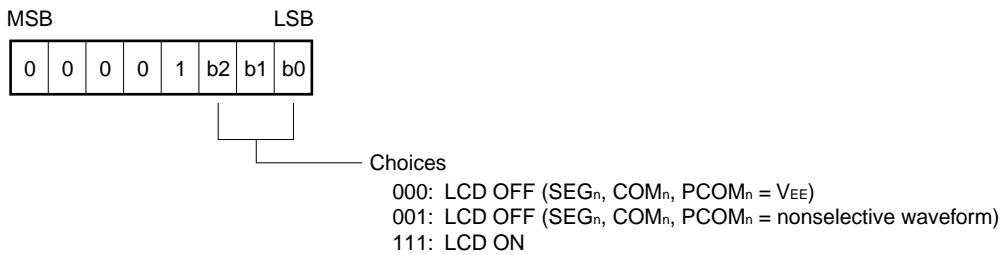

5.3.3 Standby

The DC/DC converter is stopped, thus reducing the supply current. The display is placed in the OFF state (SEG_n, COM_n = V_{EE}).

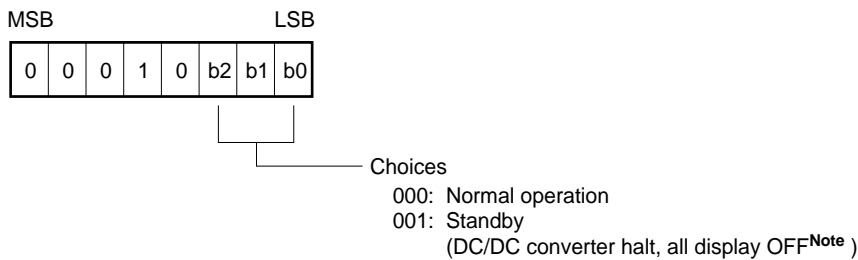

Note SEG_n, COM_n, PCOM_n = V_{EE}

5.3.4 Duty setting

The duty is set.

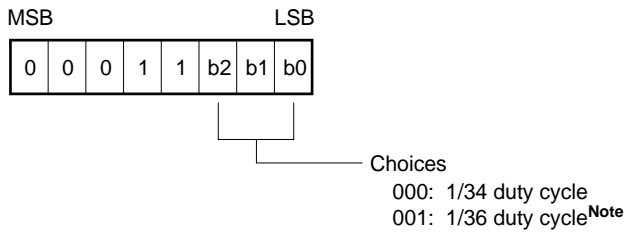

Note If the duty cycle is 1/36, PCOM₁ and PCOM₂ are respectively selected for twice the period of the duty (2/36).

5.3.5 Master/slave setting

The master/slaves are set.

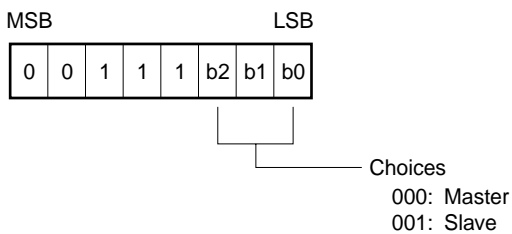

5.3.6 Blink setting

The blinks of the pictograph of the address whose blink data is "1" are controlled.

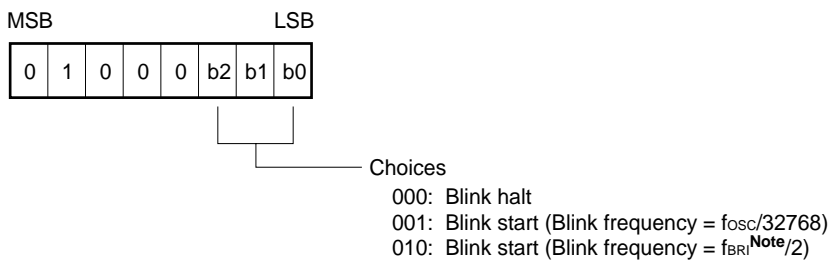

Note This refers to the frequency of the external clock which is input from the OSC_{BRI} pin.

5.3.7 Data R/W mode

Data Read/Write (R/W), increment, address counter resetting, etc. are set in this mode.

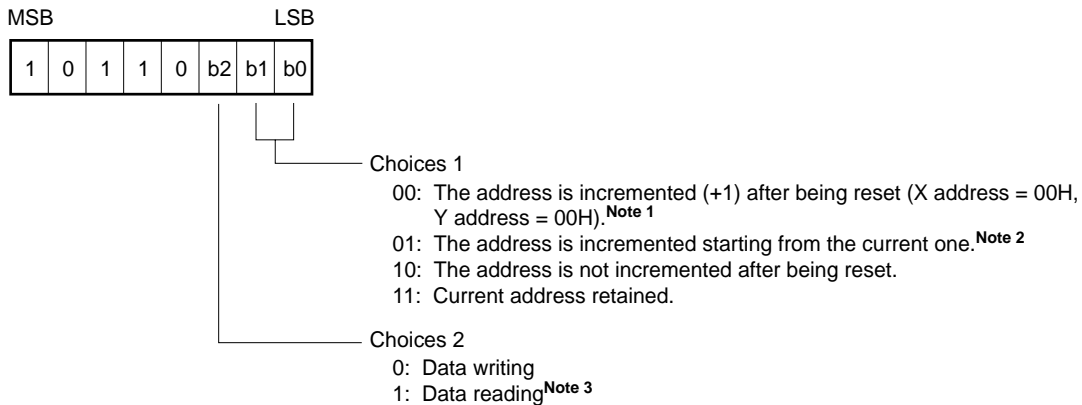

- Notes**
1. When the X address goes to the last address, the next address is 00H.
 2. The data Read mode is cancelled at STB's rising edge (switched to data Write mode).
 3. In 4-bit parallel interface mode, data cannot be read out.

5.3.8 Test mode

The test mode is set. The test mode is for checking IC operation, and no assurance is made for its regular use or continued operation.

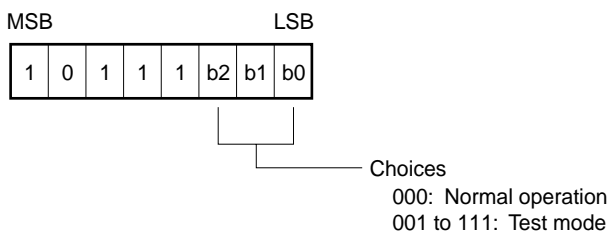

5.3.9 D/A converter setting

D/A converter output is set in 32 steps from V_{DD2} to $2/3 V_{DD2}$.

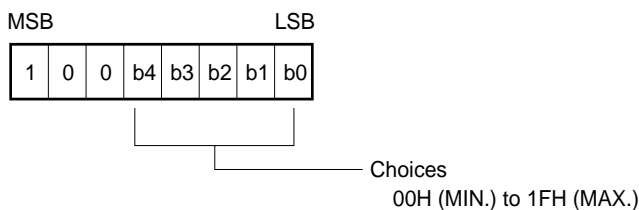

10H is set after reset.

5.4 Address Register

Selects the address type and specifies the address.

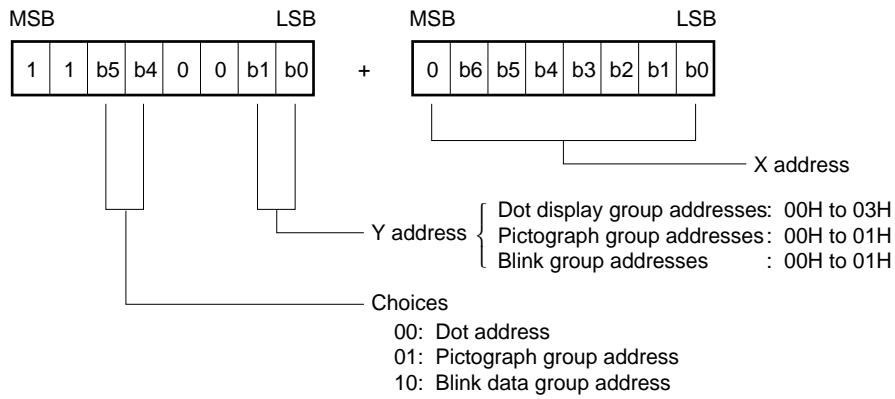

Caution If unspecified addresses have been set, the operation is not assured.

6. RESETTING

When reset (power-ON reset, command reset, hardware (terminal) reset), the contents of each register are as follows:

Register name	Register contents								Status
	b7	b6	b5	b4	b3	b2	b1	b0	
Chip address register	0	0	0	0	0	0	0	0	The ICs of CS ₂ = 0, CS ₁ = 0, CS ₀ = 0 can be accessed.
Display ON/OFF	0	0	0	0	1	0	0	0	LCD OFF (SEG _n , COM _n , PCOM _n = V _{LC5})
Standby	0	0	0	1	0	0	0	0	Normal operation
Duty setting	0	0	0	1	1	0	0	0	1/34 duty cycle
Blink setting	0	1	0	0	0	0	0	0	Blink halt
D/A converter setting	1	0	0	0	0	0	0	0	LCD drive voltage: Set to 2/3 V _{DD2}
Data R/W mode	1	0	1	1	0	0	0	0	Data write/address reset/increment (+1)
Test mode	1	0	1	1	1	0	0	0	Normal operation

7. COMMUNICATION FORMAT

7.1 Serial

7.1.1 Reception 1 (Command/data write: 1 byte)

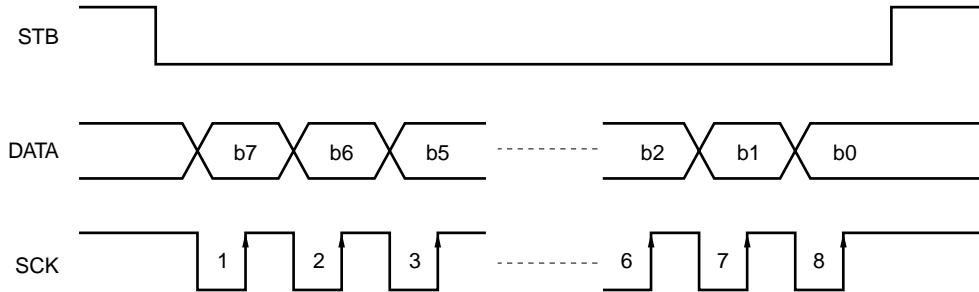

7.1.2 Reception 2 (Command/data write: 2 bytes or more)

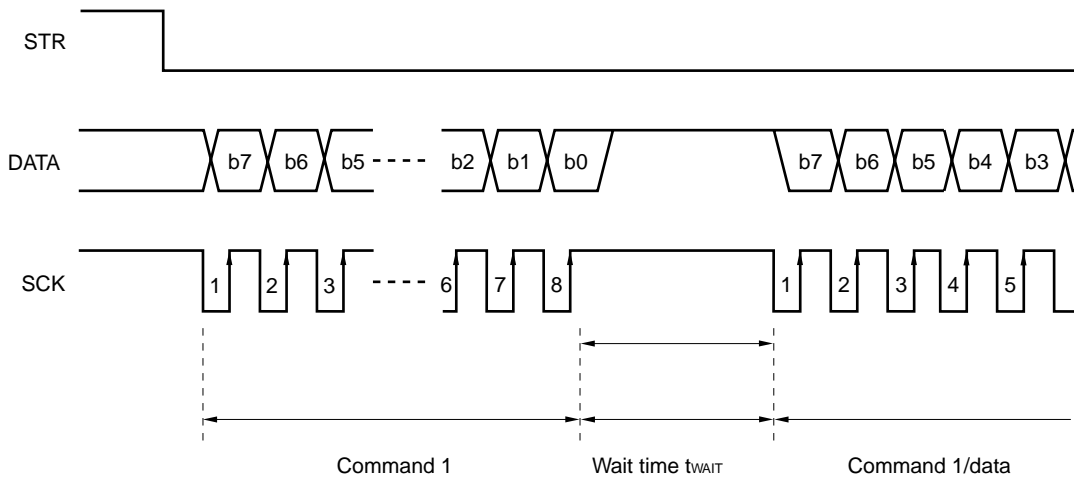

7.1.3 Transmission (Command/data read)

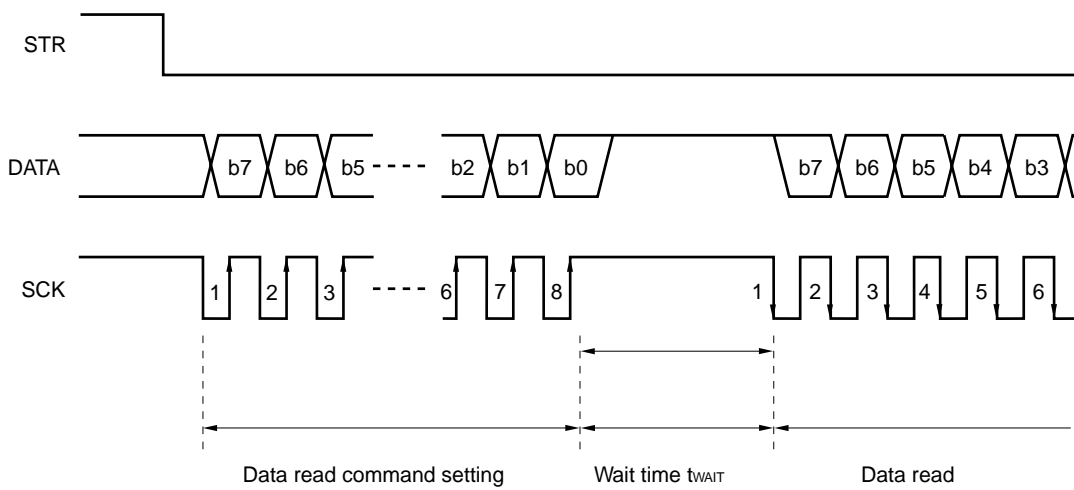

7.2 Parallel

7.2.1 8-bit parallel interface

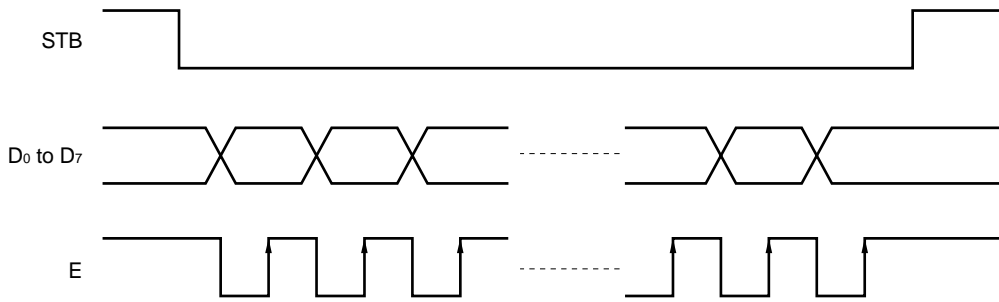

7.2.2 4-bit parallel interface

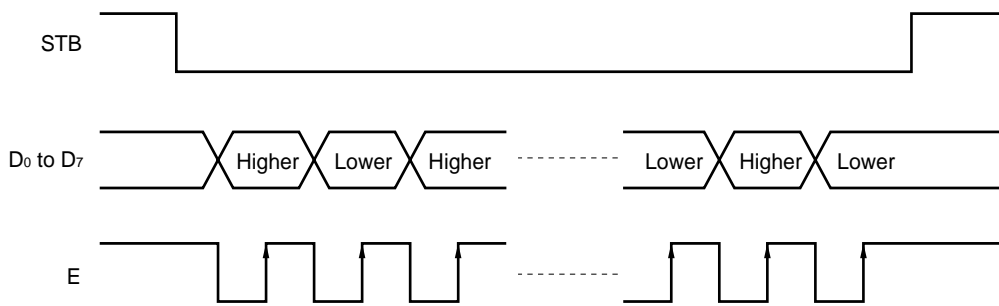

8. CPU ACCESS EXAMPLES

Examples of access procedure are shown below. In serial or 4-bit parallel interface mode, the Chip Address Register (CAR) is not transmitted when the CAR is invalid (CAE = L, see page 13).

8.1 Initialize and Data Write

Parameter	STB	Command/data								Description
		b7	b6	b5	b4	b3	b2	b1	b0	
Start	H	X	X	X	X	X	X	X	X	(Power-on reset is released 200 μs after power supply is started)
Chip Address Register (CAR)	L	0	0	0	0	0	0	0	0	Chip address = 000
Duty setting	L	0	0	0	1	1	0	0	0	1/34 duty
	H	X	X	X	X	X	X	X	X	
CAR	L	0	0	0	0	0	0	0	0	Chip address = 000
D/A converter setting	L	1	0	0	1	0	0	0	0	D/A converter output = 10000H
	H	X	X	X	X	X	X	X	X	
CAR	L	0	0	0	0	0	0	0	0	Chip address = 000
Address register 1	L	1	1	0	0	0	0	0	0	Dot address, Y address = 00H
Address register 2	L	0	0	0	0	0	0	0	0	X address = 00H
	H	X	X	X	X	X	X	X	X	
CAR	L	0	0	0	0	0	0	0	0	Chip address = 000
Data R/W mode	L	1	0	1	1	0	0	0	1	Data write, the address is incremented starting from the current one.
Dot display data 1 Dot display data 128	L L	D D	D D	D D	D D	D D	D D	D D	D D	} Data of Y address = 00H (128 bytes)
Dot display data 1 Dot display data 128	L L	D D	D D	D D	D D	D D	D D	D D	D D	} Data of Y address = 01H (128 bytes)
Dot display data 1 Dot display data 128	L L	D D	D D	D D	D D	D D	D D	D D	D D	} Data of Y address = 02H (128 bytes)
Dot display data 1 Dot display data 128	L L	D D	D D	D D	D D	D D	D D	D D	D D	} Data of Y address = 03H (128 bytes)
	H	X	X	X	X	X	X	X	X	
CAR	L	0	0	0	0	0	0	0	0	Chip address = 000
Address register 1	L	1	1	0	1	0	0	0	0	Pictograph group address, Y address = 00H
Address register 2	L	0	0	0	0	0	0	0	0	X address = 00H
	H	X	X	X	X	X	X	X	X	
CAR	L	0	0	0	0	0	0	0	0	Chip address = 000

Remark X = Don't Care, D = Data

8.1 Initialize and Data Write (Continued)

Parameter	STB	Command/data								Description
		b7	b6	b5	b4	b3	b2	b1	b0	
Data R/W mode	L	1	0	1	1	0	0	0	1	Data write, the address is incremented starting from the current one.
Pict display data 1 Pict display data 16	L L	D	D	D	D	D	D	D	D	} Data of Y address = 00H (16 bytes)
Pict display data 1 Pict display data 16	L L	D	D	D	D	D	D	D	D	
Pict display data 1 Pict display data 16	L L	D	D	D	D	D	D	D	D	} Data of Y address = 01H (16 bytes)
	L L	D	D	D	D	D	D	D	D	
	H	X	X	X	X	X	X	X	X	
CAR	L	0	0	0	0	0	0	0	0	Chip address = 000
Display ON/OFF	L	0	0	0	0	1	1	1	1	LCD ON
End	H	X	X	X	X	X	X	X	X	

Remark X = Don't Care, D = Data

8.2 Change Display Data and Pictographic Data (All Data are Changed)

Parameter	STB	Command/data								Description
		b7	b6	b5	b4	b3	b2	b1	b0	
Start	H	X	X	X	X	X	X	X	X	
Chip Address Register (CAR)	L	0	0	0	0	0	0	0	0	Chip address = 000
Address register 1	L	1	1	0	0	0	0	0	0	Dot address, Y address = 00H
Address register 2	L	0	0	0	0	0	0	0	0	X address = 00H
	H	X	X	X	X	X	X	X	X	
CAR	L	0	0	0	0	0	0	0	0	Chip address = 000
Data R/W mode	L	1	0	1	1	0	0	0	1	Data write, the address is incremented starting from the current one.
Dot display data 1 Dot display data 128	L L	D	D	D	D	D	D	D	D	} Data of Y address = 00H (128 bytes)
Dot display data 1 Dot display data 128	L L	D	D	D	D	D	D	D	D	} Data of Y address = 01H (128 bytes)
Dot display data 1 Dot display data 128	L L	D	D	D	D	D	D	D	D	} Data of Y address = 02H (128 bytes)
Dot display data 1 Dot display data 128	L L	D	D	D	D	D	D	D	D	} Data of Y address = 03H (128 bytes)
	H	X	X	X	X	X	X	X	X	
CAR	L	0	0	0	0	0	0	0	0	Chip address = 000
Address register 1	L	1	1	0	1	0	0	0	0	Pictograph group address, Y address = 00H
Address register 2	L	0	0	0	0	0	0	0	0	X address = 00H
	H	X	X	X	X	X	X	X	X	
CAR	L	0	0	0	0	0	0	0	0	Chip address = 000
Data R/W mode	L	1	0	1	1	0	0	0	1	Data write, the address is incremented starting from the current one.
Pict display data 1 Pict display data 16	L L	D	D	D	D	D	D	D	D	} Data of Y address = 00H (16 bytes)
Pict display data 1 Pict display data 16	L L	D	D	D	D	D	D	D	D	} Data of Y address = 01H (16 bytes)
End	H	X	X	X	X	X	X	X	X	

Remark X = Don't Care, D = Data

8.3 Read Display Data and Pictograph Data

Parameter	STB	Command/data								Description
		b7	b6	b5	b4	b3	b2	b1	b0	
Start	H	X	X	X	X	X	X	X	X	
Chip Address Register (CAR)	L	0	0	0	0	0	0	0	0	Chip address = 000
Address register 1	L	1	1	0	0	0	0	0	0	Dot address, Y address = 00H
Address register 2	L	0	0	0	0	0	0	0	0	X address = 00H
	H	X	X	X	X	X	X	X	X	
CAR	L	0	0	0	0	0	0	0	0	Chip address = 000
Data R/W mode	L	1	0	1	1	0	1	0	1	Data write, the address is incremented starting from the current one.
Dot display data 1 Dot display data 128	L L	D D	D D	D D	D D	D D	D D	D D	D D	} Data of Y address = 00H (128 bytes)
Dot display data 1 Dot display data 128	L L	D D	D D	D D	D D	D D	D D	D D	D D	} Data of Y address = 01H (128 bytes)
Dot display data 1 Dot display data 128	L L	D D	D D	D D	D D	D D	D D	D D	D D	} Data of Y address = 02H (128 bytes)
Dot display data 1 Dot display data 128	L L	D D	D D	D D	D D	D D	D D	D D	D D	} Data of Y address = 03H (128 bytes)
	H	X	X	X	X	X	X	X	X	
CAR	L	0	0	0	0	0	0	0	0	Chip address = 000
Address register 1	L	1	1	0	1	0	0	0	0	Pictograph group address, Y address = 00H
Address register 2	L	0	0	0	0	0	0	0	0	X address = 00H
	H	X	X	X	X	X	X	X	X	
CAR	L	0	0	0	0	0	0	0	0	Chip address = 000
Data R/W mode	L	1	0	1	1	0	1	0	1	Data write, the address is incremented starting from the current one.
Pict display data 1 Pict display data 16	L L	D D	D D	D D	D D	D D	D D	D D	D D	} Data of Y address = 00H (16 bytes)
	H	X	X	X	X	X	X	X	X	
Pict display data 1 Pict display data 16	L L	D D	D D	D D	D D	D D	D D	D D	D D	} Data of Y address = 01H (16 bytes)
End	H	X	X	X	X	X	X	X	X	

Remark X = Don't Care, D = Data

8.4 Blink Data Setting

Parameter	STB	Command/data								Description
		b7	b6	b5	b4	b3	b2	b1	b0	
Start	H	X	X	X	X	X	X	X	X	
Chip Address Register (CAR)	L	0	0	0	0	0	0	0	0	Chip address = 000
Address register 1	L	1	1	1	0	0	0	0	0	Blink data group address, Y address = 00H
Address register 2	L	0	0	0	0	0	0	0	0	X address = 00H
	H	X	X	X	X	X	X	X	X	
CAR	L	0	0	0	0	0	0	0	0	Chip address = 000
Data R/W mode	L	1	0	1	1	0	0	0	1	Data write, the address is incremented starting from the current one.
Blink display data 1 Blink display data 16	L L	D	D	D	D	D	D	D	D	} Data of Y address = 00H (16 bytes)
Blink display data 1 Blink display data 16	L L	D	D	D	D	D	D	D	D	
Blink display data 1 Blink display data 16	L L	D	D	D	D	D	D	D	D	} Data of Y address = 01H (16 bytes)
	H	X	X	X	X	X	X	X	X	
CAR	L	0	0	0	0	0	0	0	0	Chip address = 000
Blink setting	L	0	1	0	0	0	0	1	0	Start blinking, blink frequency = $f_{BRI}/2$
End	H	X	X	X	X	X	X	X	X	

Remark X = Don't Care, D = Data

9. ELECTRICAL CHARACTERISTICS

Absolute Maximum Ratings (TA = +25°C, VSS = VEE = 0 V)

Parameter	Symbol	Rating	Unit
Logic supply voltage	V _{DD1}	-0.3 to +7.0	V
Booster circuit supply voltage (V _{CHA} = H)	V _{DD2}	-0.3 to +5.0, V _{DD1} ≤ V _{DD2}	V
Booster circuit supply voltage (V _{CHA} = L)	V _{DD2}	-0.3 to +7.0, V _{DD1} ≤ V _{DD2}	V
Driver supply voltage	V _{LCD}	-0.3 to +15.0, V _{DD2} ≤ V _{LCD}	V
Driver reference supply input voltage	V _{LC1} to V _{LC5}	-0.3 to V _{LCD} +0.3	V
Logic system input voltage	V _{IN1}	-0.3 to V _{DD1} +0.3	V
Logic system output voltage	V _{OUT1}	-0.3 to V _{DD1} +0.3	V
Logic system input/output voltage	V _{I/O1}	-0.3 to V _{DD1} +0.3	V
Driver system input voltage	V _{IN2}	-0.3 to V _{LCD} +0.3	V
Driver system output voltage	V _{OUT2}	-0.3 to +V _{LCD} +0.3	V
Operating temperature	T _A	-40 to +85	°C
Storage temperature	T _{stg}	-55 to +150	°C

Caution If the absolute maximum rating of even one of the above parameters is exceeded even momentarily, the quality of the product may be degraded. Absolute maximum ratings, therefore, specify the values exceeding which the product may be physically damaged. Be sure to use the product within the range of the absolute maximum ratings.

Recommended Operating Range

Parameter	Symbol	MIN.	TYP.	MAX.	Unit
Logic supply voltage	V _{DD1} ^{Note 1}	2.7		3.3	V
Booster circuit supply voltage (V _{CHA} = H)	V _{DD2} ^{Note 1}	2.7	3.0	3.6	V
Booster circuit supply voltage (V _{CHA} = L)	V _{DD2} ^{Note 1}	2.7	5.0	5.5	V
Driver supply voltage	V _{LCD} ^{Note 2}	V _{DD2}	10	12	V
Logic system input voltage	V _{IN}	0		V _{DD1}	V
Driver system input voltage	V _{LC1} to V _{LC5}	0		V _{LCD}	V

Notes 1. Set this to V_{DD1} ≤ V_{DD2}.

2. If use external LCD voltage as V_{LCD}, cannot use standby. Also, maintain V_{DD1} = V_{DD2}.

Caution At power on and power off, keep V_{DD1} ≤ V_{DD2} ≤ V_{LCD}.

Electrical Specifications

(Unless otherwise specified, $T_A = -40$ to $+85^\circ\text{C}$, $V_{DD1} = 2.7$ to 3.3 V, $V_{CHA} = \text{H}$: $V_{DD2} = 2.7$ to 3.6 V or $V_{CHA} = \text{L}$: $V_{DD2} = 2.7$ to 5.5 V)

Parameter	Symbol	Condition	MIN.	TYP.	MAX.	Unit
High level input voltage	V_{IH}		0.8 V_{DD1}			V
Low level input voltage	V_{IL}				0.2 V_{DD1}	V
High level input current	I_{IH1}	Except D_0/DATA , D_1 to D_7/NS , D_{ACHA}			1	μA
Low level input current	I_{IL1}	Except D_0/DATA , D_1 to D_7/NS , D_{ACHA}			-1	μA
High level output voltage	V_{OH}	$I_{OUT} = -1.5$ mA, except OSC_{OUT}	V_{DD1} -0.5			V
Low level output voltage	V_{OL}	$I_{OUT} = 4$ mA, except OSC_{OUT}			0.5	V
High level leakage current	I_{LOH}	D_0/DATA , D_1 to D_7/NS $V_{IN/OUT} = V_{DD1}$			10	μA
Low level leakage current	I_{LOL}	D_0/DATA , D_1 to D_7/NS $V_{IN/OUT} = V_{SS}$			-10	μA
Common output ON resistance	R_{COM}	$V_{LCn} \rightarrow \text{COM}_n$, $V_{LCD} \geq 2 V_{DD2}$ $ I_o = 50 \mu\text{A}$			2	$\text{k}\Omega$
Segment output ON resistance	R_{SEG}	$V_{LCn} \rightarrow \text{SEG}_n$, $V_{LCD} \geq 2 V_{DD2}$ $ I_o = 50 \mu\text{A}$			4	$\text{k}\Omega$
Driver supply voltage (Booster voltage)	V_{LCD}	$V_{CHA} = \text{L}$, Note	1.8 V_{DD2}		2.0 V_{DD2}	V
		$V_{CHA} = \text{H}$, Note	2.7 V_{DD2}		3.0 V_{DD2}	V
Logic system current consumption (V_{DD1})	I_{DD11}	$f_{OSC} = 30$ kHz, no load $V_{DD1} = V_{DD2} = 3.0$ V, Not to access RAM			30	μA
		$f_{OSC} = 30$ kHz, no load $V_{DD1} = V_{DD2} = 3.0$ V, To access RAM			60	μA
Driver system current consumption (V_{DD2})	I_{DD21}	$f_{OSC} = 30$ kHz, All display OFF data output, $V_{DD1} = V_{DD2} = 3.0$ V, $V_{CHA} = \text{H}$, Note			150	μA

Remark The TYP. value is a reference value when $T_A = 25^\circ\text{C}$.

Note Measurement circuit

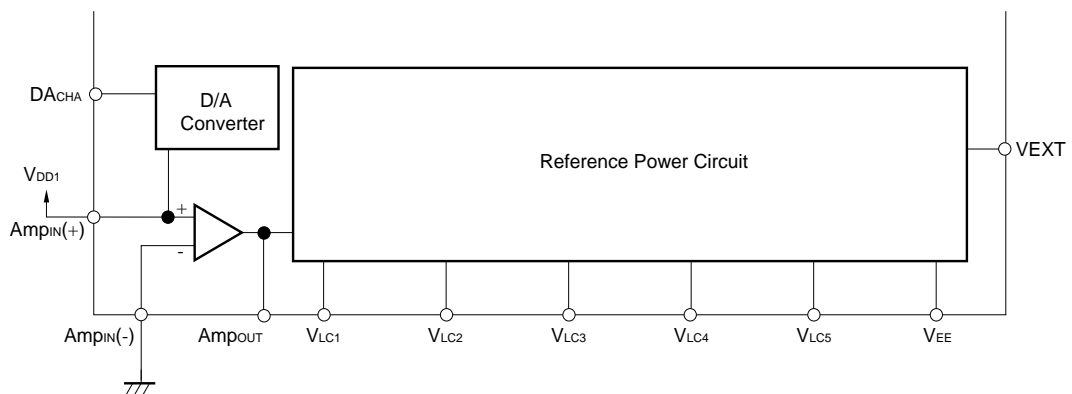

Switching Characteristics

(Unless otherwise specified, T_A = -40 to +85°C, V_{DD1} = 2.7 to 3.3 V, V_{CHA} = H: V_{DD2} = 2.7 to 3.6 V or V_{CHA} = L: V_{DD2} = 2.7 to 5.5 V)

Parameter	Symbol	Condition	MIN.	TYP.	MAX.	Unit
Oscillation frequency	f _{osc}	Self-oscillation	21	30	50	kHz
Transfer delay time	t _{PHL}	SCK↓→DATA↓			100	ns
	t _{PLH}	SCK↓→DATA↑			300	ns

Remark The TYP. value is a reference value when T_A = 25°C.

The time for one frame is obtained with the following formula.

$$1 \text{ frame} = 1/f_{osc} \times 8 \times \text{number of duties}$$

If f_{osc} = 30 kHz and 1/34 duty, then the result is:

$$1 \text{ frame} = 33 \mu\text{s} \times 8 \times 34 = 9.1 \text{ ms}$$

Required Conditions for Timing

(Unless otherwise specified, T_A = -40 to +85°C, V_{DD1} = 2.7 to 3.3 V, V_{CHA} = H: V_{DD2} = 2.7 to 3.6 V or V_{CHA} = L: V_{DD2} = 2.7 to 5.5 V)

(1) Common

Parameter	Symbol	Condition	MIN.	TYP.	MAX.	Unit
Clock frequency	f _{osc}	OSC _{IN} external clock	20	30	50	kHz
High level clock pulse width	t _{WHC1}	OSC _{IN} external clock	10		25	μs
Low level clock pulse width	t _{WLC1}	OSC _{IN} external clock	10		25	μs
High level clock pulse width	t _{WHC2}	OSC _{BRI} external clock	400			ns
Low level clock pulse width	t _{WLC2}	OSC _{BRI} external clock	400			ns
Rise/fall time	t _r , t _f	OSC _{BRI} external clock			100	ns
Reset pulse width	t _{WRE}	Reset pin	1.0			μs

Remark The TYP. value is a reference value when T_A = 25°C.

(2) Serial interface

Parameter	Symbol	Condition	MIN.	TYP.	MAX.	Unit
Shift clock cycle	t _{CYK}	SCK	900			ns
High level shift clock pulse width	t _{WHK}	SCK	400			ns
Low level shift clock pulse width	t _{WLK}	SCK	400			ns
Shift clock hold time	t _{HSTBK}	STB↓→SCK↓	1.5			μs
Data setup time	t _{DS1}	DATA→SCK↑	100			ns
Data hold time	t _{DH1}	SCK↑→DATA	400			ns
STB hold time	t _{HKSTB}	SCK↑→STB↑	1			μs
STB pulse width	t _{WSTB}		1			μs
Wait time	t _{WAIT}	8th CLK↑→1st CLK↓	1			μs

Remark The TYP. value is a reference value when T_A = 25°C.

(3) Parallel interface (8-bit/4-bit)

Parameter	Symbol	Condition	MIN.	TYP.	MAX.	Unit
Enable cycle time	t _{CYCE}	E↑→E↑	900			ns
High level enable pulse width	t _{WHE}	E	400			ns
Low level enable pulse width	t _{WLE}	E	400			ns
STB pulse width	t _{WSTB}		1			μs
STB hold time	t _{HKSTB}		1			μs
Enable hold time	t _{HSTBK}		1.5			μs
Data setup time	t _{DS2}	D ₀ to D ₇ →E↑	100			ns
Data hold time	t _{DH2}	D ₀ to D ₇ →E↓	300			ns

Remarks 1. The TYP. value is a reference value when T_A = 25°C.

2. In 4-bit parallel mode, D₀ to D₃ = "L".

Switching Characteristics Waveforms

AC Measurement Point

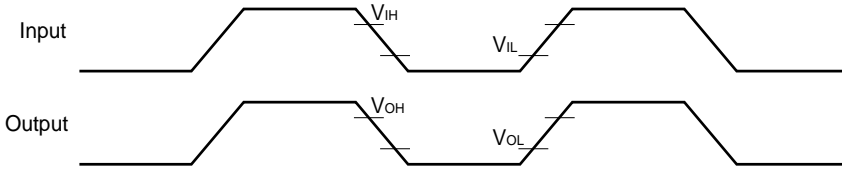

AC Characteristics Waveform

OSC

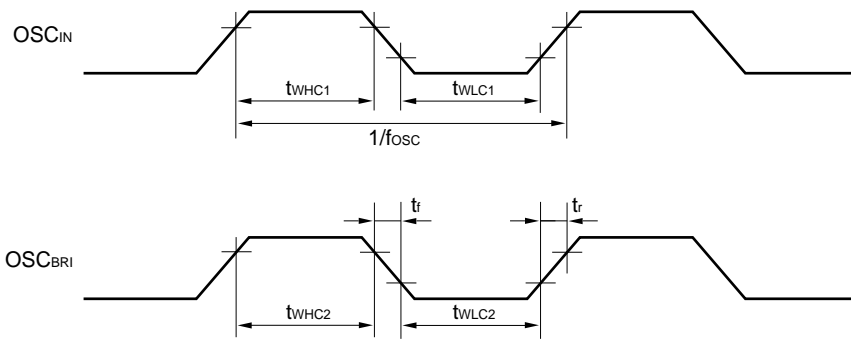

Serial interface (input)

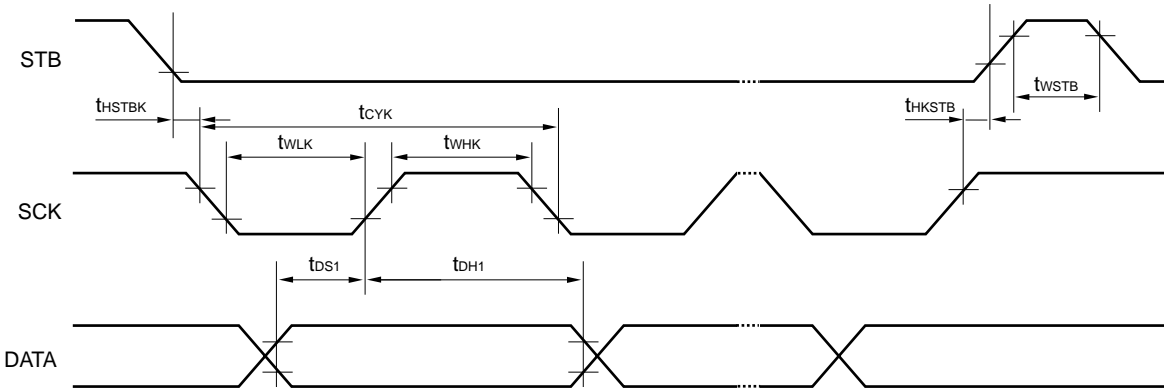

Serial interface (output)

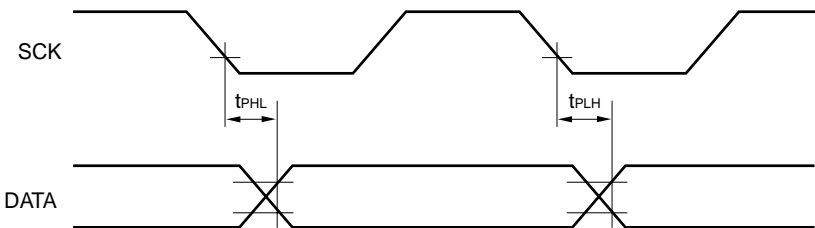

8-bit parallel interface

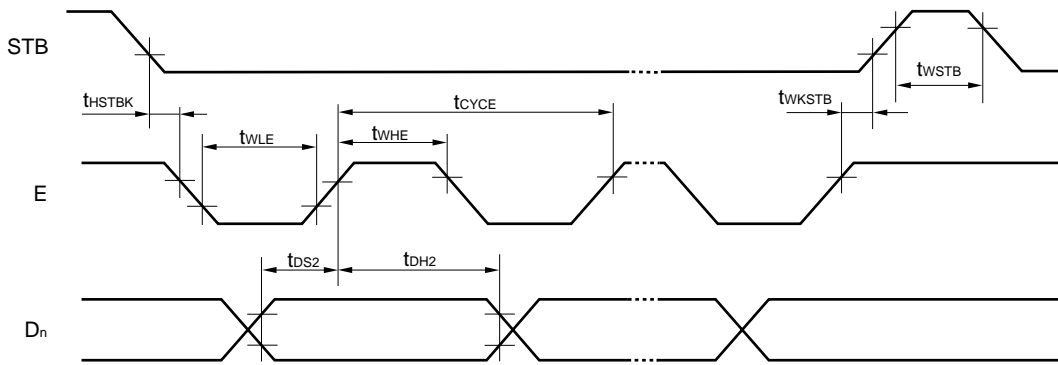

4-bit parallel interface

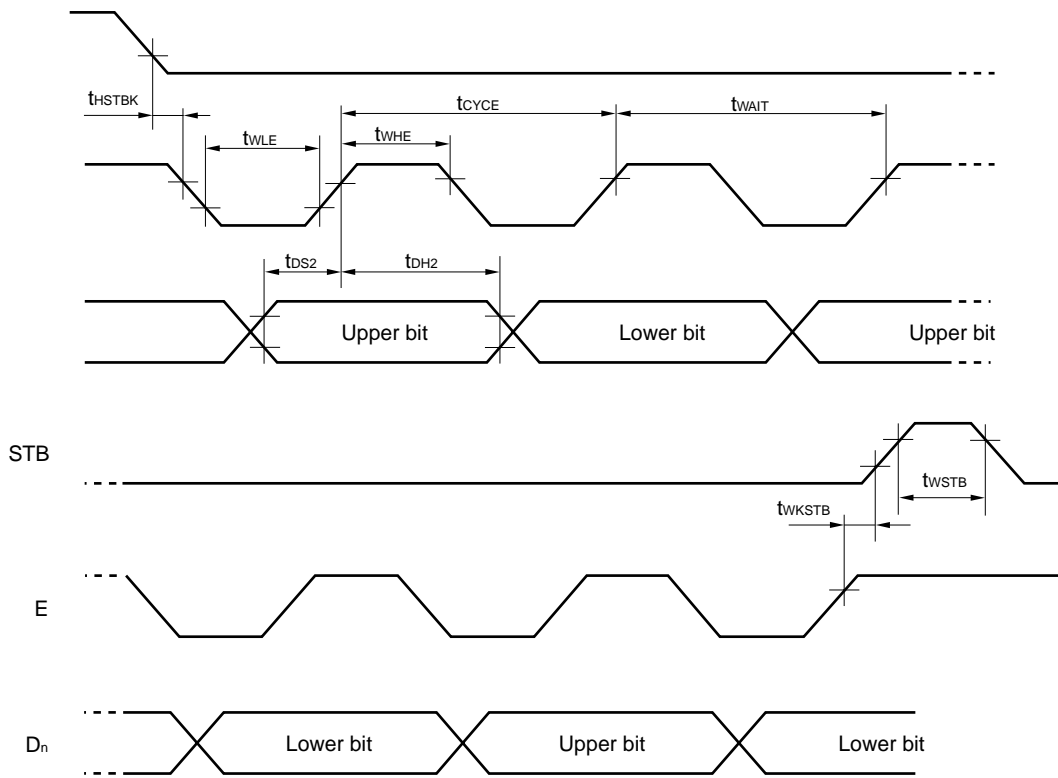

Reset

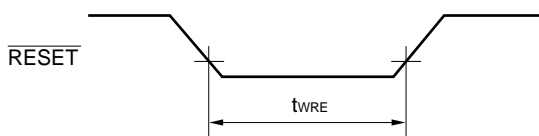

10. PACKAGE DRAWING

Standard TCP Drawing (μPD16675AN-051)

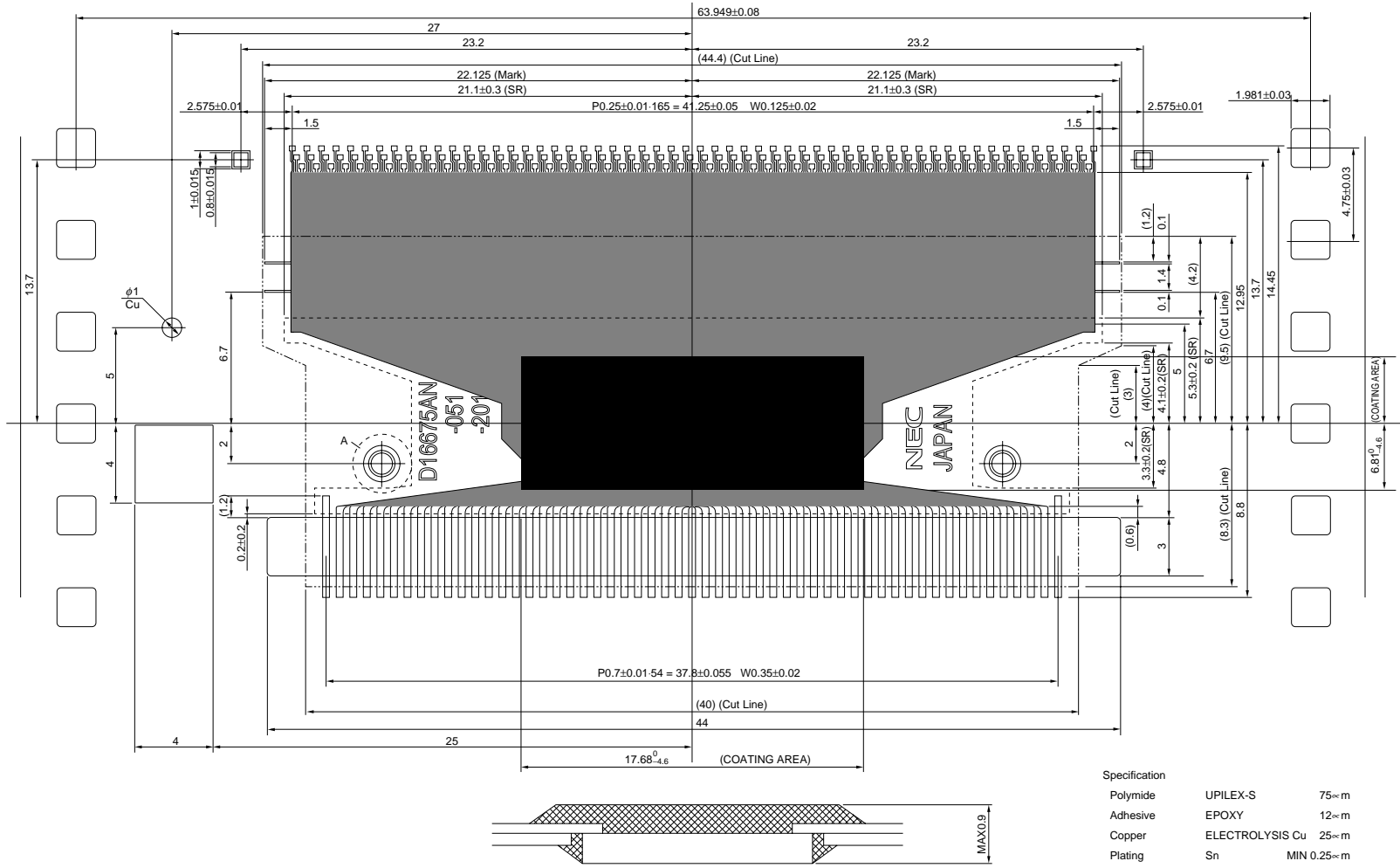

Standard TCP Drawing (μPD16675AN-051)

Detail of test pad

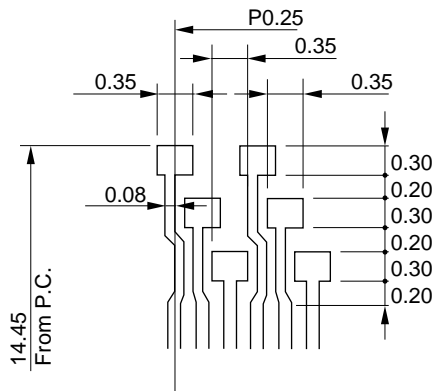

Detail of "A" part

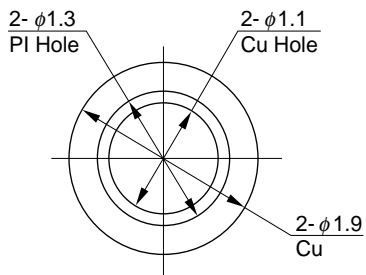

Tape unwinding direction

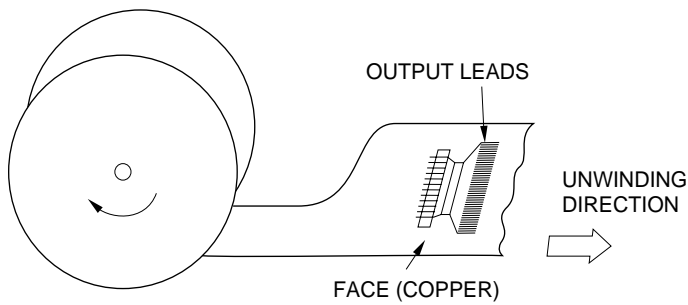

Standard TCP Drawing (μPD16675AN-051)

Pin configuration

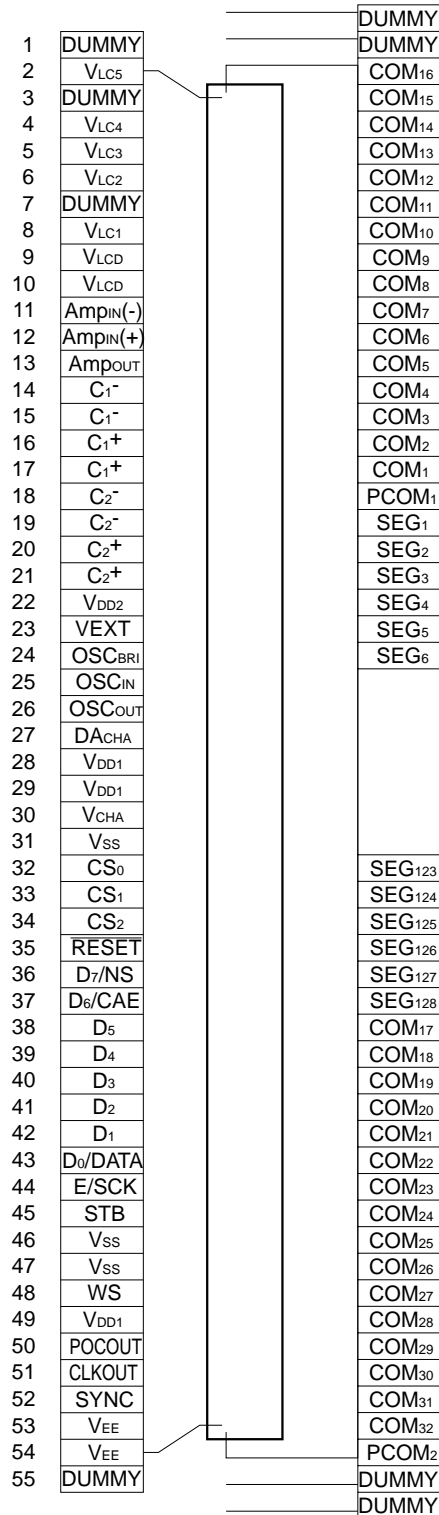

NOTES FOR CMOS DEVICES

① PRECAUTION AGAINST ESD FOR SEMICONDUCTORS

Note: Strong electric field, when exposed to a MOS device, can cause destruction of the gate oxide and ultimately degrade the device operation. Steps must be taken to stop generation of static electricity as much as possible, and quickly dissipate it once, when it has occurred. Environmental control must be adequate. When it is dry, humidifier should be used. It is recommended to avoid using insulators that easily build static electricity. Semiconductor devices must be stored and transported in an anti-static container, static shielding bag or conductive material. All test and measurement tools including work bench and floor should be grounded. The operator should be grounded using wrist strap. Semiconductor devices must not be touched with bare hands. Similar precautions need to be taken for PW boards with semiconductor devices on it.

② HANDLING OF UNUSED INPUT PINS FOR CMOS

Note: No connection for CMOS device inputs can be cause of malfunction. If no connection is provided to the input pins, it is possible that an internal input level may be generated due to noise, etc., hence causing malfunction. CMOS devices behave differently than Bipolar or NMOS devices. Input levels of CMOS devices must be fixed high or low by using a pull-up or pull-down circuitry. Each unused pin should be connected to V_{DD} or GND with a resistor, if it is considered to have a possibility of being an output pin. All handling related to the unused pins must be judged device by device and related specifications governing the devices.

③ STATUS BEFORE INITIALIZATION OF MOS DEVICES

Note: Power-on does not necessarily define initial status of MOS device. Production process of MOS does not define the initial operation status of the device. Immediately after the power source is turned ON, the devices with reset function have not yet been initialized. Hence, power-on does not guarantee out-pin levels, I/O settings or contents of registers. Device is not initialized until the reset signal is received. Reset operation must be executed immediately after power-on for devices having reset function.

Reference

Document	Number
Quality Grades on NEC's Semiconductor Devices	C11531E
Semiconductor Device Mounting Technology Manual	C10535E

The application circuits and their parameters are for reference only and are not intended for use in actual design-ins.

No part of this document may be copied or reproduced in any form or by any means without the prior written consent of NEC Corporation. NEC Corporation assumes no responsibility for any errors which may appear in this document.

NEC Corporation does not assume any liability for infringement of patents, copyrights or other intellectual property rights of third parties by or arising from use of a device described herein or any other liability arising from use of such device. No license, either express, implied or otherwise, is granted under any patents, copyrights or other intellectual property rights of NEC Corporation or others.

While NEC Corporation has been making continuous effort to enhance the reliability of its semiconductor devices, the possibility of defects cannot be eliminated entirely. To minimize risks of damage or injury to persons or property arising from a defect in an NEC semiconductor device, customers must incorporate sufficient safety measures in its design, such as redundancy, fire-containment, and anti-failure features.

NEC devices are classified into the following three quality grades:

"Standard", "Special", and "Specific". The Specific quality grade applies only to devices developed based on a customer designated "quality assurance program" for a specific application. The recommended applications of a device depend on its quality grade, as indicated below. Customers must check the quality grade of each device before using it in a particular application.

Standard: Computers, office equipment, communications equipment, test and measurement equipment, audio and visual equipment, home electronic appliances, machine tools, personal electronic equipment and industrial robots

Special: Transportation equipment (automobiles, trains, ships, etc.), traffic control systems, anti-disaster systems, anti-crime systems, safety equipment and medical equipment (not specifically designed for life support)

Specific: Aircrafts, aerospace equipment, submersible repeaters, nuclear reactor control systems, life support systems or medical equipment for life support, etc.

The quality grade of NEC devices is "Standard" unless otherwise specified in NEC's Data Sheets or Data Books. If customers intend to use NEC devices for applications other than those specified for Standard quality grade, they should contact an NEC sales representative in advance.

Anti-radioactive design is not implemented in this product.