

FEATURES

High speed

350 MHz, -3 dB bandwidth

1200 V/ μ s slew rate

Resistor set gain

Internal common-mode feedback

Improved gain and phase balance

-68 dB @ 10 MHz

Separate input to set the common-mode output voltage

Low distortion: -99 dBc SFDR @ 5 MHz, 800 Ω load

Low power: 10.7 mA @ 5 V

Power supply range: +2.7 V to \pm 5.5 V

APPLICATIONS

Low power differential ADC drivers

Differential gain and differential filtering

Video line drivers

Differential in/out level shifting

Single-ended input to differential output drivers

Active transformers

GENERAL DESCRIPTION

The AD8132 is a low cost differential or single-ended input to differential output amplifier with resistor set gain. The AD8132 is a major advancement over op amps for driving differential input ADCs or for driving signals over long lines. The AD8132 has a unique internal feedback feature that provides output gain and phase matching balanced to -68 dB at 10 MHz, suppressing harmonics and reducing radiated EMI.

Manufactured using the next generation of Analog Devices, Inc.'s XFCB bipolar process, the AD8132 has a -3 dB bandwidth of 350 MHz and delivers a differential signal with -99 dBc SFDR at 5 MHz, despite its low cost. The AD8132 eliminates the need for a transformer with high performance ADCs, preserving the low frequency and dc information. The common-mode level of the differential output is adjustable by applying a voltage on the V_{OCM} pin, easily level shifting the input signals for driving single-supply ADCs. Fast overload recovery preserves sampling accuracy.

PIN CONFIGURATION

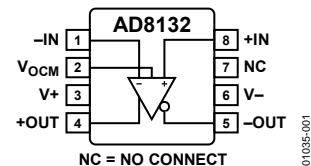

Figure 1.

The AD8132 is also used as a differential driver for the transmission of high speed signals over low cost twisted pair or coaxial cables. The feedback network can be adjusted to boost the high frequency components of the signal. The AD8132 is used for either analog or digital video signals or for other high speed data transmission. The AD8132 is capable of driving either a Category 3 or Category 5 twisted pair or coaxial cable with minimal line attenuation. The AD8132 has considerable cost and performance improvements over discrete line driver solutions.

Differential signal processing reduces the effects of ground noise that plagues ground-referenced systems. The AD8132 can be used for differential signal processing (gain and filtering) throughout a signal chain, easily simplifying the conversion between differential and single-ended components.

The AD8132 is available in both SOIC_N and MSOP packages for operation over the extended industrial temperature range of -40°C to +125°C.

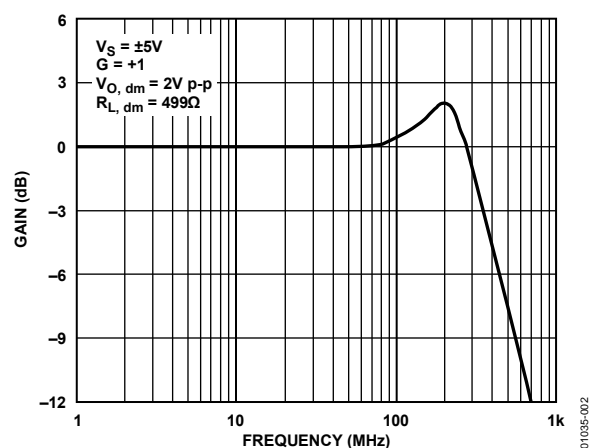

Figure 2. Large Signal Frequency Response

Rev. F

Information furnished by Analog Devices is believed to be accurate and reliable. However, no responsibility is assumed by Analog Devices for its use, nor for any infringements of patents or other rights of third parties that may result from its use. Specifications subject to change without notice. No license is granted by implication or otherwise under any patent or patent rights of Analog Devices. Trademarks and registered trademarks are the property of their respective owners.

TABLE OF CONTENTS

Features	1	Differential Amplifier Without Resistors (High Input Impedance Inverting Amplifier)	21
Applications.....	1	Other $\beta_2 = 1$ Circuits	22
General Description	1	Varying β_2	22
Pin Configuration.....	1	$\beta_1 = 0$	22
Revision History	2	Estimating the Output Noise Voltage	22
Specifications.....	3	Calculating Input Impedance of the Application Circuit	23
$\pm D_{IN}$ to $\pm OUT$ Specifications.....	3	Input Common-Mode Voltage Range in Single-Supply Applications	23
V_{OCM} to $\pm OUT$ Specifications	4	Setting the Output Common-Mode Voltage	23
$\pm D_{IN}$ to $\pm OUT$ Specifications.....	5	Driving a Capacitive Load.....	23
V_{OCM} to $\pm OUT$ Specifications	6	Open-Loop Gain and Phase	23
$\pm D_{IN}$ to $\pm OUT$ Specifications.....	7	Layout, Grounding, and Bypassing.....	24
V_{OCM} to $\pm OUT$ Specifications	7	Circuits.....	24
Absolute Maximum Ratings.....	8	Applications.....	25
Thermal Resistance	8	Analog-to-Digital Driver	25
ESD Caution.....	8	Balanced Cable Driver	25
Pin Configuration and Function Descriptions.....	9	Transmit Equalizer	26
Typical Performance Characteristics	10	Low-Pass Differential Filter	26
Test Circuits.....	19	High Common-Mode Output Impedance Amplifier	27
Operational Description.....	20	Full-Wave Rectifier	28
Definition of Terms	20	Outline Dimensions	29
Basic Circuit Operation	20	Ordering Guide	29
Theory of Operation	21		
General Usage of the AD8132	21		

REVISION HISTORY

11/06—Rev. E to Rev. F

Updated Format.....	Universal
Changes to Table 1.....	3
Changes to Table 4.....	6
Changes to Table 5.....	7
Changes to Ordering Guide	29

11/05—Rev. D to Rev. E

Changes to Table 7, Thermal Resistance Section, Maximum Power Dissipation Section, and Figure 3.....	8
Changes to Ordering Guide	29

12/04—Rev. C to Rev. D

Changes to General Description	1
Changes to Specifications.....	2
Changes to Absolute Maximum Ratings.....	8
Updated Outline Dimensions.....	29
Changes to Ordering Guide.....	29

2/03—Rev. B to Rev. C

Changes to Specifications.....	2
Addition to Estimating the Output Noise Voltage Section.....	15
Updated Outline Dimensions	21

1/02—Rev. A to Rev. B

Edits to Transmitter Equalizer Section.....	18
---	----

SPECIFICATIONS

$\pm D_{IN}$ TO $\pm OUT$ SPECIFICATIONS

At $T_A = 25^\circ\text{C}$, $V_S = \pm 5\text{ V}$, $V_{OCM} = 0\text{ V}$, $G = 1$, $R_{L, dm} = 499\ \Omega$, $R_F = R_G = 348\ \Omega$, unless otherwise noted. For $G = 2$, $R_{L, dm} = 200\ \Omega$, $R_F = 1000\ \Omega$, $R_G = 499\ \Omega$. Refer to Figure 56 and Figure 57 for test setup and label descriptions. All specifications refer to single-ended input and differential outputs, unless otherwise noted.

Table 1.

Parameter	Conditions	Min	Typ	Max	Unit
DYNAMIC PERFORMANCE					
-3 dB Large Signal Bandwidth	$V_{OUT} = 2\text{ V p-p}$	300	350		MHz
	$V_{OUT} = 2\text{ V p-p}$, $G = 2$		190		MHz
-3 dB Small Signal Bandwidth	$V_{OUT} = 0.2\text{ V p-p}$		360		MHz
	$V_{OUT} = 0.2\text{ V p-p}$, $G = 2$		160		MHz
Bandwidth for 0.1 dB Flatness	$V_{OUT} = 0.2\text{ V p-p}$		90		MHz
	$V_{OUT} = 0.2\text{ V p-p}$, $G = 2$		50		MHz
Slew Rate	$V_{OUT} = 2\text{ V p-p}$	1000	1200		V/ μs
Settling Time	0.1%, $V_{OUT} = 2\text{ V p-p}$		15		ns
Overdrive Recovery Time	$V_{IN} = 5\text{ V to }0\text{ V step}$, $G = 2$		5		ns
NOISE/HARMONIC PERFORMANCE					
Second Harmonic	$V_{OUT} = 2\text{ V p-p}$, 1 MHz, $R_{L, dm} = 800\ \Omega$		-96		dBc
	$V_{OUT} = 2\text{ V p-p}$, 5 MHz, $R_{L, dm} = 800\ \Omega$		-83		dBc
	$V_{OUT} = 2\text{ V p-p}$, 20 MHz, $R_{L, dm} = 800\ \Omega$		-73		dBc
Third Harmonic	$V_{OUT} = 2\text{ V p-p}$, 1 MHz, $R_{L, dm} = 800\ \Omega$		-102		dBc
	$V_{OUT} = 2\text{ V p-p}$, 5 MHz, $R_{L, dm} = 800\ \Omega$		-98		dBc
	$V_{OUT} = 2\text{ V p-p}$, 20 MHz, $R_{L, dm} = 800\ \Omega$		-67		dBc
IMD	20 MHz, $R_{L, dm} = 800\ \Omega$		-76		dBc
IP3	20 MHz, $R_{L, dm} = 800\ \Omega$		40		dBm
Input Voltage Noise (RTI)	$f = 0.1\text{ MHz to }100\text{ MHz}$		8		nV/ $\sqrt{\text{Hz}}$
Input Current Noise	$f = 0.1\text{ MHz to }100\text{ MHz}$		1.8		pA/ $\sqrt{\text{Hz}}$
Differential Gain Error	NTSC, $G = 2$, $R_{L, dm} = 150\ \Omega$		0.01		%
Differential Phase Error	NTSC, $G = 2$, $R_{L, dm} = 150\ \Omega$		0.10		Degrees
INPUT CHARACTERISTICS					
Offset Voltage (RTI)	$V_{OS, dm} = V_{OUT, dm}/2$; $V_{DIN+} = V_{DIN-} = V_{OCM} = 0\text{ V}$		± 1.0	± 3.5	mV
	T_{MIN} to T_{MAX} variation		10		$\mu\text{V}/^\circ\text{C}$
Input Bias Current		3		7	μA
Input Resistance	Differential		12		M Ω
	Common mode		3.5		M Ω
Input Capacitance			1		pF
Input Common-Mode Voltage			-4.7 to +3.0		V
CMRR	$\Delta V_{OUT, dm}/\Delta V_{IN, cm}$; $\Delta V_{IN, cm} = \pm 1\text{ V}$; resistors matched to 0.01%		-70	-60	dB
OUTPUT CHARACTERISTICS					
Output Voltage Swing	Maximum ΔV_{OUT} ; single-ended output		-3.6 to +3.6		V
Output Current			+70		mA
Output Balance Error	$\Delta V_{OUT, cm}/\Delta V_{OUT, dm}$; $\Delta V_{OUT, dm} = 1\text{ V}$		-70		dB

AD8132

V_{OCM} TO ±OUT SPECIFICATIONS

At T_A = 25°C, V_S = ±5 V, V_{OCM} = 0 V, G = 1, R_{L, dm} = 499 Ω, R_F = R_G = 348 Ω, unless otherwise noted. For G = 2, R_{L, dm} = 200 Ω, R_F = 1000 Ω, R_G = 499 Ω. Refer to Figure 56 and Figure 57 for test setup and label descriptions. All specifications refer to single-ended input and differential outputs, unless otherwise noted.

Table 2.

Parameter	Conditions	Min	Typ	Max	Unit
DYNAMIC PERFORMANCE					
-3 dB Bandwidth	$\Delta V_{OCM} = 600$ mV p-p		210		MHz
Slew Rate	$\Delta V_{OCM} = -1$ V to +1 V		400		V/μs
Input Voltage Noise (RTI)	f = 0.1 MHz to 100 MHz		12		nV/√Hz
DC PERFORMANCE					
Input Voltage Range			±3.6		V
Input Resistance			50		kΩ
Input Offset Voltage	V _{OS, cm} = V _{OUT, cm} ; V _{DIN+} = V _{DIN-} = V _{OCM} = 0 V		±1.5	±7	mV
Input Bias Current			0.5		μA
V _{OCM} CMRR	$\Delta V_{OUT, dm}/\Delta V_{OCM}$; $\Delta V_{OCM} = \pm 1$ V; resistors matched to 0.01%		-68		dB
Gain	$\Delta V_{OUT, cm}/\Delta V_{OCM}$; $\Delta V_{OCM} = \pm 1$ V	0.985	1	1.015	V/V
POWER SUPPLY					
Operating Range		±1.35		±5.5	V
Quiescent Current	V _{DIN+} = V _{DIN-} = V _{OCM} = 0 V	11	12	13	mA
	T _{MIN} to T _{MAX} variation		16		μA/°C
Power Supply Rejection Ratio	$\Delta V_{OUT, dm}/\Delta V_S$; $\Delta V_S = \pm 1$ V		-70	-60	dB
OPERATING TEMPERATURE RANGE					
		-40		+125	°C

±D_{IN} TO ±OUT SPECIFICATIONS

At $T_A = 25^\circ\text{C}$, $V_S = 5\text{ V}$, $V_{\text{OCM}} = 2.5\text{ V}$, $G = 1$, $R_{L, \text{dm}} = 499\ \Omega$, $R_F = R_G = 348\ \Omega$, unless otherwise noted. For $G = 2$, $R_{L, \text{dm}} = 200\ \Omega$, $R_F = 1000\ \Omega$, $R_G = 499\ \Omega$. Refer to Figure 56 and Figure 57 for test setup and label descriptions. All specifications refer to single-ended input and differential outputs, unless otherwise noted.

Table 3.

Parameter	Conditions	Min	Typ	Max	Unit
DYNAMIC PERFORMANCE					
–3 dB Large Signal Bandwidth	$V_{\text{OUT}} = 2\text{ V p-p}$	250	300		MHz
	$V_{\text{OUT}} = 2\text{ V p-p}$, $G = 2$		180		MHz
–3 dB Small Signal Bandwidth	$V_{\text{OUT}} = 0.2\text{ V p-p}$		360		MHz
	$V_{\text{OUT}} = 0.2\text{ V p-p}$, $G = 2$		155		MHz
Bandwidth for 0.1 dB Flatness	$V_{\text{OUT}} = 0.2\text{ V p-p}$		65		MHz
	$V_{\text{OUT}} = 0.2\text{ V p-p}$, $G = 2$		50		MHz
Slew Rate	$V_{\text{OUT}} = 2\text{ V p-p}$	800	1000		V/ μs
Settling Time	0.1%, $V_{\text{OUT}} = 2\text{ V p-p}$		20		ns
Overdrive Recovery Time	$V_{\text{IN}} = 2.5\text{ V}$ to 0 V step, $G = 2$		5		ns
NOISE/HARMONIC PERFORMANCE					
Second Harmonic	$V_{\text{OUT}} = 2\text{ V p-p}$, 1 MHz, $R_{L, \text{dm}} = 800\ \Omega$		–97		dBc
	$V_{\text{OUT}} = 2\text{ V p-p}$, 5 MHz, $R_{L, \text{dm}} = 800\ \Omega$		–100		dBc
	$V_{\text{OUT}} = 2\text{ V p-p}$, 20 MHz, $R_{L, \text{dm}} = 800\ \Omega$		–74		dBc
Third Harmonic	$V_{\text{OUT}} = 2\text{ V p-p}$, 1 MHz, $R_{L, \text{dm}} = 800\ \Omega$		–100		dBc
	$V_{\text{OUT}} = 2\text{ V p-p}$, 5 MHz, $R_{L, \text{dm}} = 800\ \Omega$		–99		dBc
	$V_{\text{OUT}} = 2\text{ V p-p}$, 20 MHz, $R_{L, \text{dm}} = 800\ \Omega$		–67		dBc
IMD	20 MHz, $R_{L, \text{dm}} = 800\ \Omega$		–76		dBc
IP3	20 MHz, $R_{L, \text{dm}} = 800\ \Omega$		40		dBm
Input Voltage Noise (RTI)	$f = 0.1\text{ MHz to }100\text{ MHz}$		8		nV/ $\sqrt{\text{Hz}}$
Input Current Noise	$f = 0.1\text{ MHz to }100\text{ MHz}$		1.8		pA/ $\sqrt{\text{Hz}}$
Differential Gain Error	NTSC, $G = 2$, $R_{L, \text{dm}} = 150\ \Omega$		0.025		%
Differential Phase Error	NTSC, $G = 2$, $R_{L, \text{dm}} = 150\ \Omega$		0.15		Degrees
INPUT CHARACTERISTICS					
Offset Voltage (RTI)	$V_{\text{OS, dm}} = V_{\text{OUT, dm}}/2$; $V_{\text{DIN+}} = V_{\text{DIN-}} = V_{\text{OCM}} = 2.5\text{ V}$		±1.0	±3.5	mV
	T_{MIN} to T_{MAX} variation		6		$\mu\text{V}/^\circ\text{C}$
Input Bias Current			3	7	μA
Input Resistance	Differential		10		M Ω
	Common-mode		3		M Ω
Input Capacitance			1		pF
Input Common-Mode Voltage			0.3 to 3.0		V
CMRR	$\Delta V_{\text{OUT, dm}}/\Delta V_{\text{IN, cm}}$; $\Delta V_{\text{IN, cm}} = \pm 1\text{ V}$; resistors matched to 0.01%		–70	–60	dB
OUTPUT CHARACTERISTICS					
Output Voltage Swing	Maximum ΔV_{OUT} ; single-ended output		1.0 to 4.0		V
Output Current			50		mA
Output Balance Error	$\Delta V_{\text{OUT, cm}}/\Delta V_{\text{OUT, dm}}$; $\Delta V_{\text{OUT, dm}} = 1\text{ V}$		–68		dB

AD8132

V_{OCM} TO ±OUT SPECIFICATIONS

At T_A = 25°C, V_S = 5 V, V_{OCM} = 2.5 V, G = 1, R_{L, dm} = 499 Ω, R_F = R_G = 348 Ω, unless otherwise noted. For G = 2, R_{L, dm} = 200 Ω, R_F = 1000 Ω, R_G = 499 Ω. Refer to Figure 56 and Figure 57 for test setup and label descriptions. All specifications refer to single-ended input and differential outputs, unless otherwise noted.

Table 4.

Parameter	Conditions	Min	Typ	Max	Unit
DYNAMIC PERFORMANCE					
–3 dB Bandwidth	$\Delta V_{OCM} = 600 \text{ mV p-p}$		210		MHz
Slew Rate	$\Delta V_{OCM} = 1.5 \text{ V to } 3.5 \text{ V}$		340		V/μs
Input Voltage Noise (RTI)	f = 0.1 MHz to 100 MHz		12		nV/√Hz
DC PERFORMANCE					
Input Voltage Range			1.0 to 3.7		V
Input Resistance			30		kΩ
Input Offset Voltage	V _{OS, cm} = V _{OUT, cm} ; V _{DIN+} = V _{DIN-} = V _{OCM} = 2.5 V		±5	±11	mV
Input Bias Current			0.5		μA
V _{OCM} CMRR	$\Delta V_{OUT, dm}/\Delta V_{OCM}$; $\Delta V_{OCM} = 2.5 \text{ V} \pm 1 \text{ V}$; resistors matched to 0.01%		–66		dB
Gain	$\Delta V_{OUT, cm}/\Delta V_{OCM}$; $\Delta V_{OCM} = 2.5 \text{ V} \pm 1 \text{ V}$	0.985	1	1.015	V/V
POWER SUPPLY					
Operating Range		2.7		11	V
Quiescent Current	V _{DIN+} = V _{DIN-} = V _{OCM} = 2.5 V	9.4	10.7	12	mA
	T _{MIN} to T _{MAX} variation		10		μA/°C
Power Supply Rejection Ratio	$\Delta V_{OUT, dm}/\Delta V_S$; $\Delta V_S = \pm 1 \text{ V}$		–70	–60	dB
OPERATING TEMPERATURE RANGE					
		–40		+125	°C

±D_{IN} TO ±OUT SPECIFICATIONS

At $T_A = 25^\circ\text{C}$, $V_S = 3\text{ V}$, $V_{\text{OCM}} = 1.5\text{ V}$, $G = 1$, $R_{L,\text{dm}} = 499\ \Omega$, $R_F = R_G = 348\ \Omega$, unless otherwise noted. For $G = 2$, $R_{L,\text{dm}} = 200\ \Omega$, $R_F = 1000\ \Omega$, $R_G = 499\ \Omega$. Refer to Figure 56 and Figure 57 for test setup and label descriptions. All specifications refer to single-ended input and differential outputs, unless otherwise noted.

Table 5.

Parameter	Conditions	Min	Typ	Max	Unit
DYNAMIC PERFORMANCE					
-3 dB Large Signal Bandwidth	$V_{\text{OUT}} = 1\text{ V p-p}$		350		MHz
	$V_{\text{OUT}} = 1\text{ V p-p}$, $G = 2$		165		MHz
-3 dB Small Signal Bandwidth	$V_{\text{OUT}} = 0.2\text{ V p-p}$		350		MHz
	$V_{\text{OUT}} = 0.2\text{ V p-p}$, $G = 2$		150		MHz
Bandwidth for 0.1 dB Flatness	$V_{\text{OUT}} = 0.2\text{ V p-p}$		45		MHz
	$V_{\text{OUT}} = 0.2\text{ V p-p}$, $G = 2$		50		MHz
NOISE/HARMONIC PERFORMANCE					
Second Harmonic	$V_{\text{OUT}} = 1\text{ V p-p}$, 1 MHz, $R_{L,\text{dm}} = 800\ \Omega$		-100		dBc
	$V_{\text{OUT}} = 1\text{ V p-p}$, 5 MHz, $R_{L,\text{dm}} = 800\ \Omega$		-94		dBc
	$V_{\text{OUT}} = 1\text{ V p-p}$, 20 MHz, $R_{L,\text{dm}} = 800\ \Omega$		-77		dBc
Third Harmonic	$V_{\text{OUT}} = 1\text{ V p-p}$, 1 MHz, $R_{L,\text{dm}} = 800\ \Omega$		-90		dBc
	$V_{\text{OUT}} = 1\text{ V p-p}$, 5 MHz, $R_{L,\text{dm}} = 800\ \Omega$		-85		dBc
	$V_{\text{OUT}} = 1\text{ V p-p}$, 20 MHz, $R_{L,\text{dm}} = 800\ \Omega$		-66		dBc
INPUT CHARACTERISTICS					
Offset Voltage (RTI)	$V_{\text{OS, dm}} = V_{\text{OUT, dm}}/2$; $V_{\text{DIN+}} = V_{\text{DIN-}} = V_{\text{OCM}} = 1.5\text{ V}$		±10		mV
Input Bias Current			3		μA
Input Common-Mode Voltage			0.3 to 1.0		V
CMRR	$\Delta V_{\text{OUT, dm}}/\Delta V_{\text{IN, cm}}$; $\Delta V_{\text{IN, cm}} = \pm 0.5\text{ V}$; resistors matched to 0.01%		-60		dB

V_{OCM} TO ±OUT SPECIFICATIONS

At $T_A = 25^\circ\text{C}$, $V_S = 3\text{ V}$, $V_{\text{OCM}} = 1.5\text{ V}$, $G = 1$, $R_{L,\text{dm}} = 499\ \Omega$, $R_F = R_G = 348\ \Omega$, unless otherwise noted. For $G = 2$, $R_{L,\text{dm}} = 200\ \Omega$, $R_F = 1000\ \Omega$, $R_G = 499\ \Omega$. Refer to Figure 56 and Figure 57 for test setup and label descriptions. All specifications refer to single-ended input and differential outputs, unless otherwise noted.

Table 6.

Parameter	Conditions	Min	Typ	Max	Unit
DC PERFORMANCE					
Input Offset Voltage	$V_{\text{OS, cm}} = V_{\text{OUT, cm}}$; $V_{\text{DIN+}} = V_{\text{DIN-}} = V_{\text{OCM}} = 1.5\text{ V}$		±7		mV
Gain	$\Delta V_{\text{OUT, cm}}/\Delta V_{\text{OCM}}$; $\Delta V_{\text{OCM}} = \pm 0.5\text{ V}$		1		V/V
POWER SUPPLY					
Operating Range		2.7		11	V
Quiescent Current	$V_{\text{DIN+}} = V_{\text{DIN-}} = V_{\text{OCM}} = 0\text{ V}$		7.25		mA
Power Supply Rejection Ratio	$\Delta V_{\text{OUT, dm}}/\Delta V_S$; $\Delta V_S = \pm 0.5\text{ V}$		-70		dB
OPERATING TEMPERATURE RANGE					
		-40		+125	°C

ABSOLUTE MAXIMUM RATINGS

Table 7.

Parameter	Rating
Supply Voltage	± 5.5 V
V_{OCM}	$\pm V_s$
Internal Power Dissipation	250 mW
Operating Temperature Range	-40°C to $+125^{\circ}\text{C}$
Storage Temperature Range	-65°C to $+150^{\circ}\text{C}$
Lead Temperature (Soldering 10 sec)	300°C
Junction Temperature	150°C

Stresses above those listed under Absolute Maximum Ratings may cause permanent damage to the device. This is a stress rating only; functional operation of the device at these or any other conditions above those indicated in the operational section of this specification is not implied. Exposure to absolute maximum rating conditions for extended periods may affect device reliability.

THERMAL RESISTANCE

θ_{JA} is specified for the worst-case conditions, that is, θ_{JA} is specified for the device soldered in a circuit board in still air.

Table 8.

Package Type	θ_{JA}	Unit
8-Lead SOIC/4-Layer	121	$^{\circ}\text{C}/\text{W}$
8-Lead MSOP/4-Layer	142	$^{\circ}\text{C}/\text{W}$

Maximum Power Dissipation

The maximum safe power dissipation in the AD8132 packages is limited by the associated rise in junction temperature (T_j) on the die. At approximately 150°C (the glass transition temperature), the plastic changes its properties. Even temporarily exceeding this temperature limit can change the stresses that the package exerts on the die, permanently shifting the parametric performance of the AD8132. Exceeding a junction temperature of 150°C for an extended period can result in changes in the silicon devices, potentially causing failure.

ESD CAUTION



ESD (electrostatic discharge) sensitive device. Charged devices and circuit boards can discharge without detection. Although this product features patented or proprietary protection circuitry, damage may occur on devices subjected to high energy ESD. Therefore, proper ESD precautions should be taken to avoid performance degradation or loss of functionality.

The power dissipated in the package (P_D) is the sum of the quiescent power dissipation and the power dissipated in the package due to the load drive for all outputs. The quiescent power is the voltage between the supply pins (V_s) times the quiescent current (I_s). The load current consists of the differential and common-mode currents flowing to the load, as well as currents flowing through the external feedback networks and the internal common-mode feedback loop. The internal resistor tap used in the common-mode feedback loop places a $1\text{ k}\Omega$ differential load on the output. Consider rms voltages and currents when dealing with ac signals.

Airflow reduces θ_{JA} . In addition, more metal directly in contact with the package leads from metal traces through holes, ground, and power planes reduces the θ_{JA} .

Figure 3 shows the maximum safe power dissipation in the package vs. the ambient temperature for the 8-lead SOIC_N ($\theta_{JA} = 121^{\circ}\text{C}/\text{W}$) and MSOP ($\theta_{JA} = 142^{\circ}\text{C}/\text{W}$) packages on a JEDEC standard 4-layer board. θ_{JA} values are approximations.

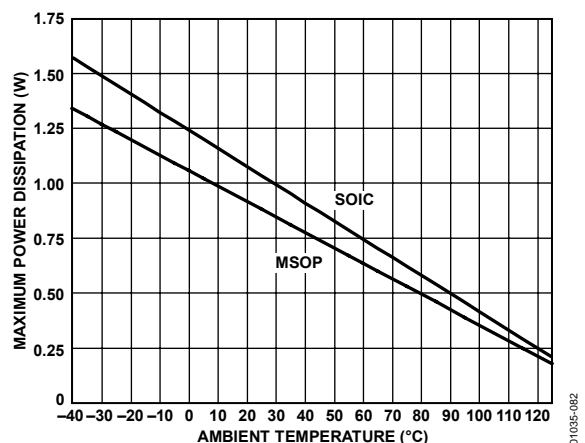

Figure 3. Maximum Power Dissipation vs. Temperature

PIN CONFIGURATION AND FUNCTION DESCRIPTIONS

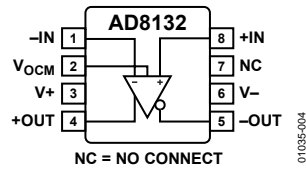

Figure 4. Pin Configuration

Table 9. Pin Function Descriptions

Pin No.	Mnemonic	Description
1	-IN	Negative Input.
2	V _{OCM}	Voltage applied to this pin sets the common-mode output voltage with a ratio of 1:1. For example, 1 V dc on V _{OCM} sets the dc bias level on +OUT and -OUT to 1 V.
3	V+	Positive Supply Voltage.
4	+OUT	Positive Output. Note that the voltage at -D _{IN} is inverted at +OUT (see Figure 64).
5	-OUT	Negative Output. Note that the voltage at +D _{IN} is inverted at -OUT (see Figure 64).
6	V-	Negative Supply Voltage.
7	NC	No Connect.
8	+IN	Positive Input.

TYPICAL PERFORMANCE CHARACTERISTICS

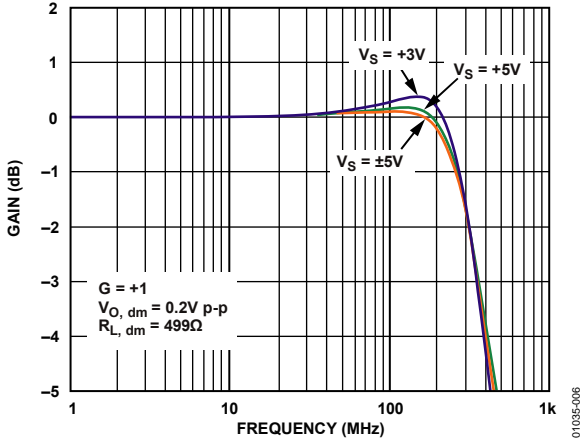

Figure 5. Small Signal Frequency Response (See Figure 56)

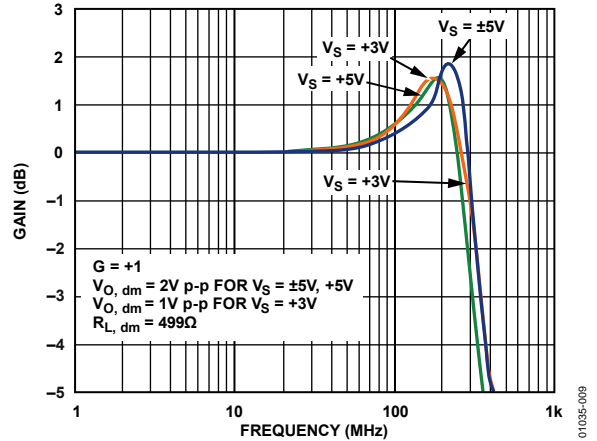

Figure 8. Large Signal Frequency Response; $C_F = 0$ pF (See Figure 56)

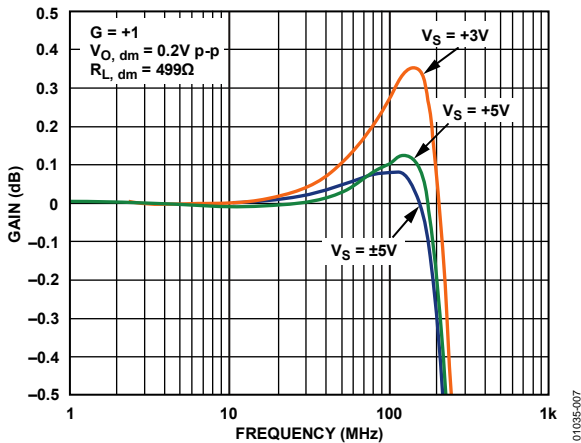

Figure 6. 0.1 dB Flatness vs. Frequency; $C_F = 0$ pF (See Figure 56)

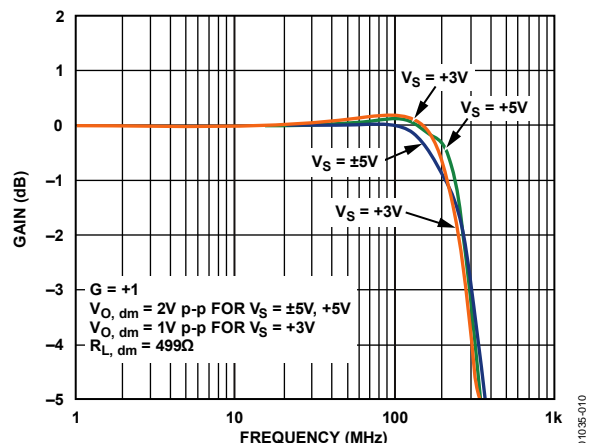

Figure 9. Large Signal Frequency Response; $C_F = 0.5$ pF (See Figure 56)

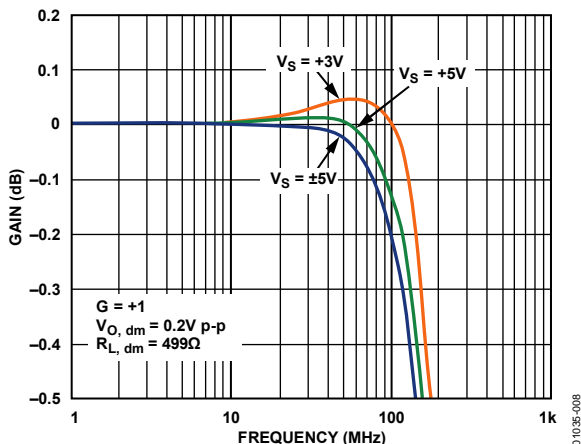

Figure 7. 0.1 dB Flatness vs. Frequency; $C_F = 0.5$ pF (See Figure 56)

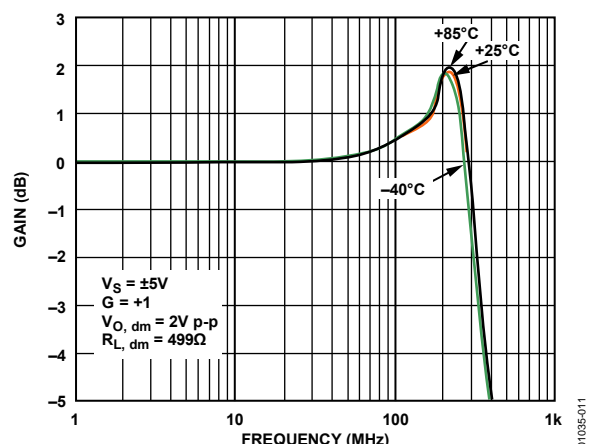

Figure 10. Large Signal Frequency Response at Various Temperatures (See Figure 56)

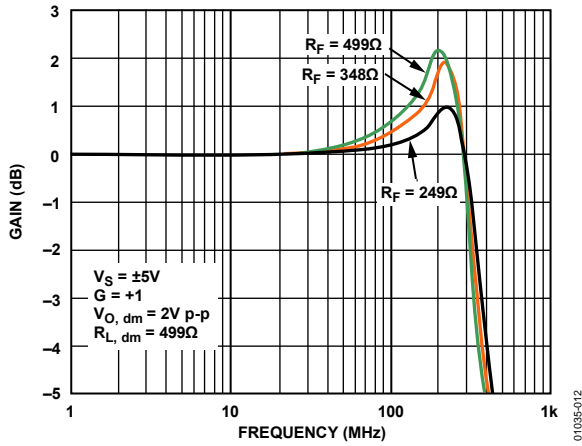

Figure 11. Large Signal Frequency Response vs. R_F (See Figure 56)

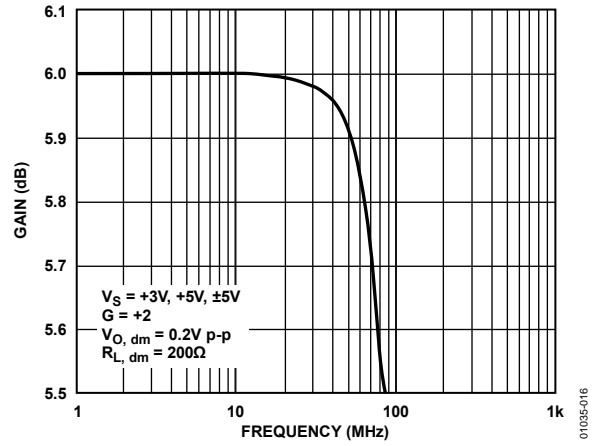

Figure 14. 0.1 dB Flatness vs. Frequency (See Figure 57)

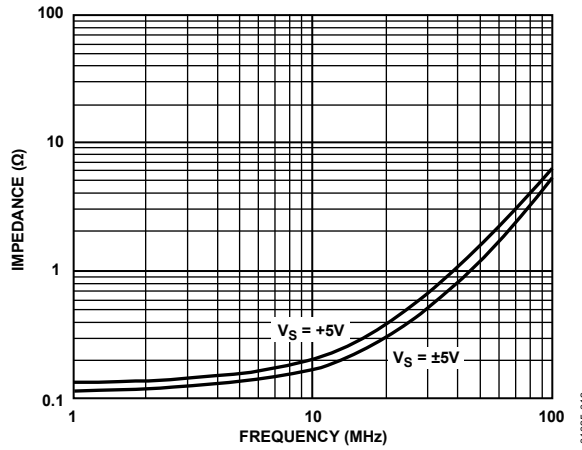

Figure 12. Closed-Loop Single-Ended Z_{OUT} vs. Frequency; $G = 1$ (See Figure 56)

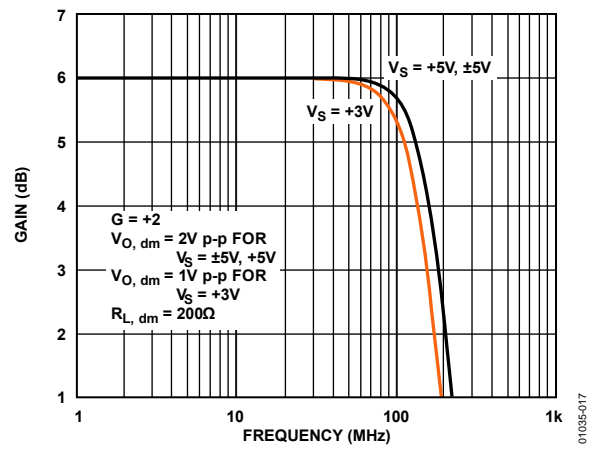

Figure 15. Large Signal Frequency Response (See Figure 57)

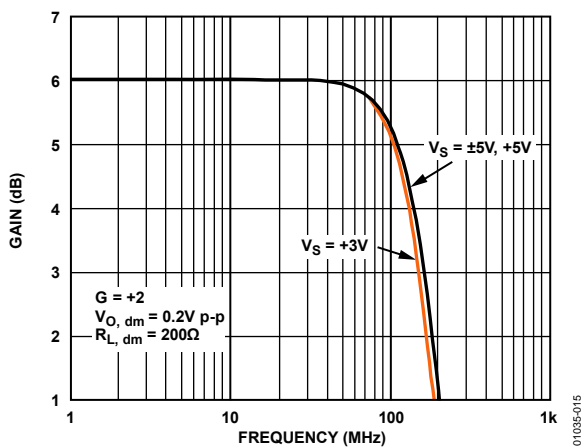

Figure 13. Small Signal Frequency Response (See Figure 57)

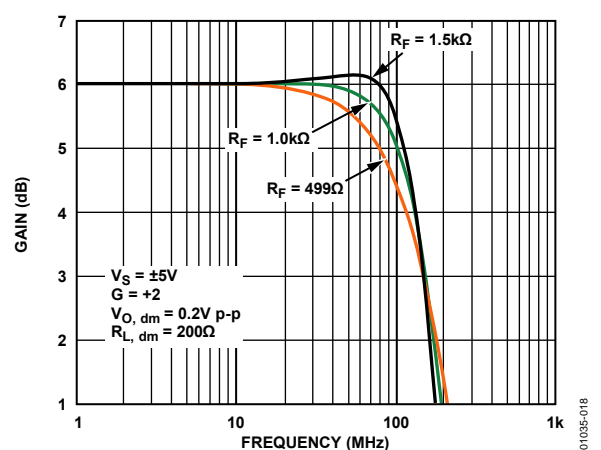

Figure 16. Small Signal Frequency Response vs. R_F (See Figure 57)

AD8132

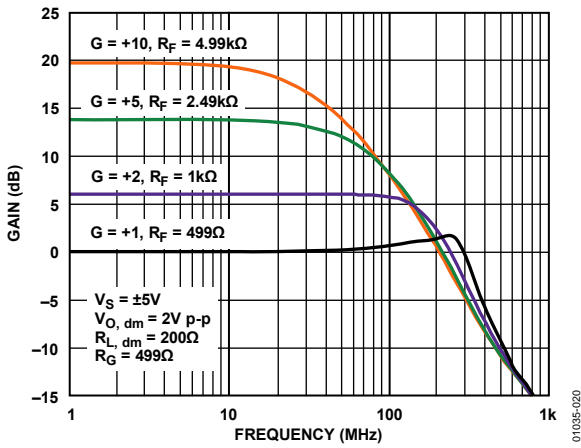

Figure 17. Large Signal Frequency Response for Various Gains (See Figure 58)

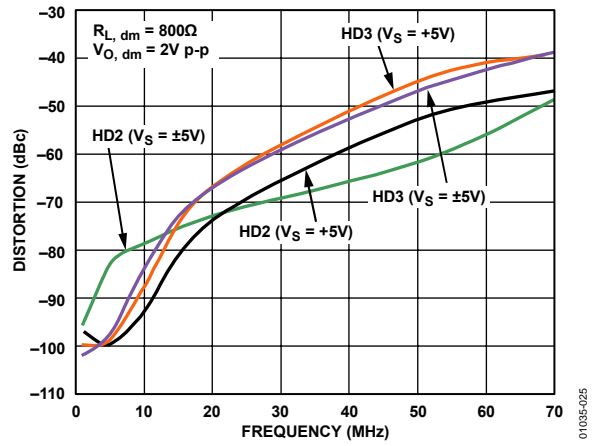

Figure 20. Harmonic Distortion vs. Frequency, $G = 1$ (See Figure 62)

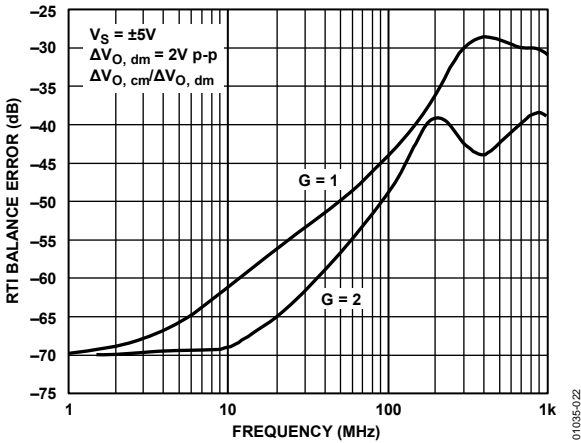

Figure 18. RTI Output Balance Error vs. Frequency (See Figure 59)

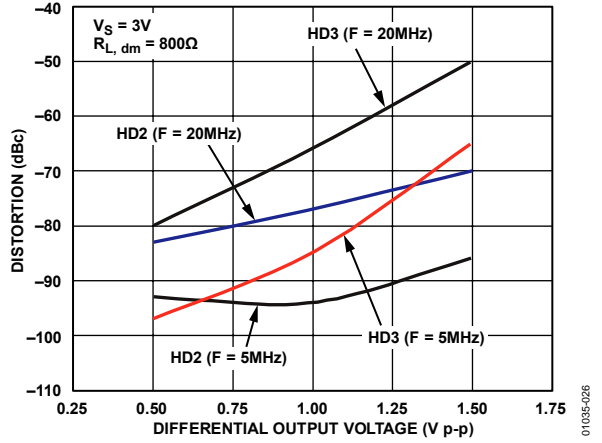

Figure 21. Harmonic Distortion vs. Differential Output Voltage, $G = 1$ (See Figure 62)

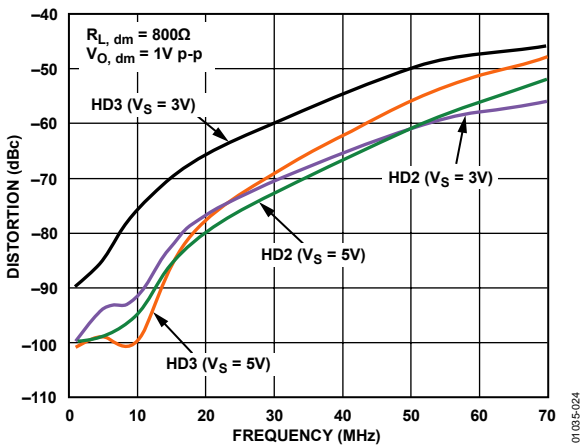

Figure 19. Harmonic Distortion vs. Frequency, $G = 1$ (See Figure 62)

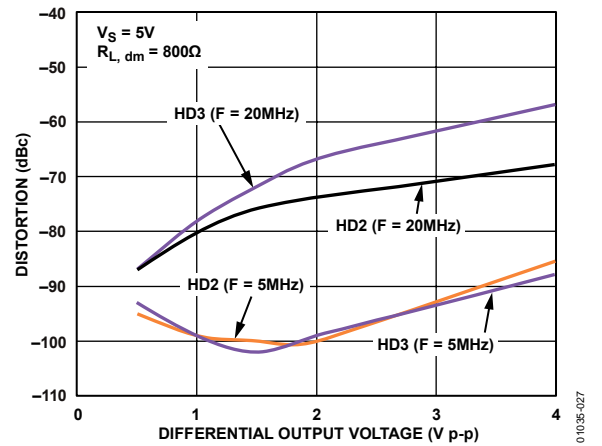

Figure 22. Harmonic Distortion vs. Differential Output Voltage, $G = 1$ (See Figure 62)

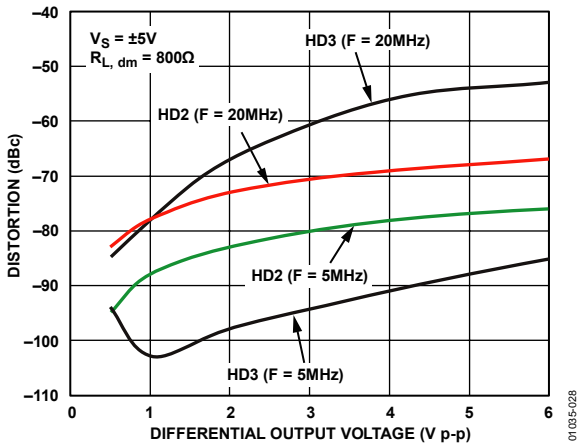

Figure 23. Harmonic Distortion vs. Differential Output Voltage, $G = 1$ (See Figure 62)

01035-028

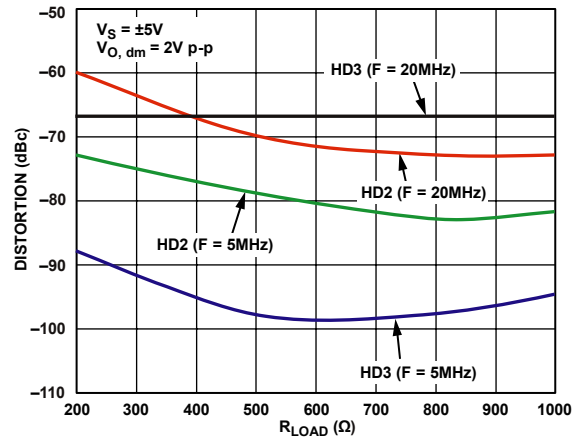

Figure 26. Harmonic Distortion vs. R_{LOAD} , $G = 1$ (See Figure 62)

01035-031

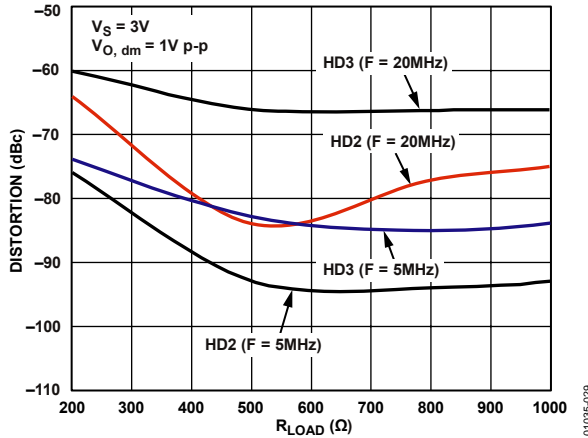

Figure 24. Harmonic Distortion vs. R_{LOAD} , $G = 1$ (See Figure 62)

01035-029

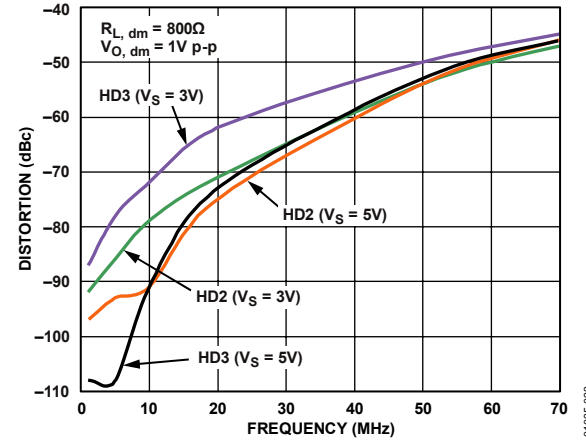

Figure 27. Harmonic Distortion vs. Frequency, $G = 2$ (See Figure 63)

01035-033

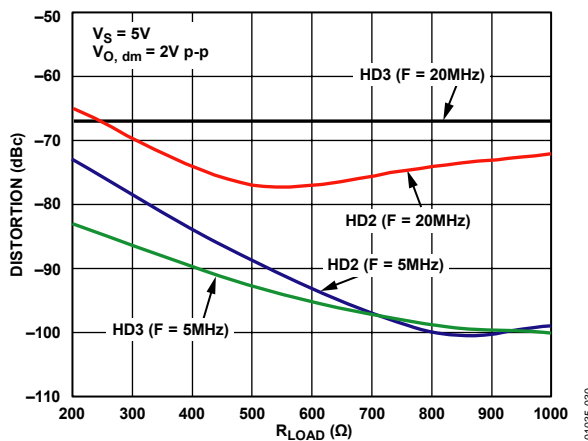

Figure 25. Harmonic Distortion vs. R_{LOAD} , $G = 1$ (See Figure 62)

01035-030

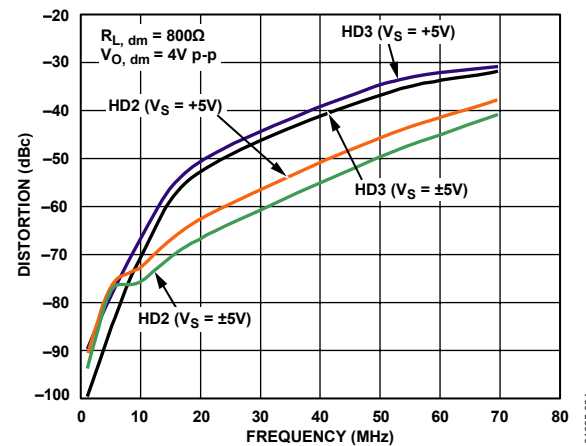

Figure 28. Harmonic Distortion vs. Frequency, $G = 2$ (See Figure 63)

01035-034

AD8132

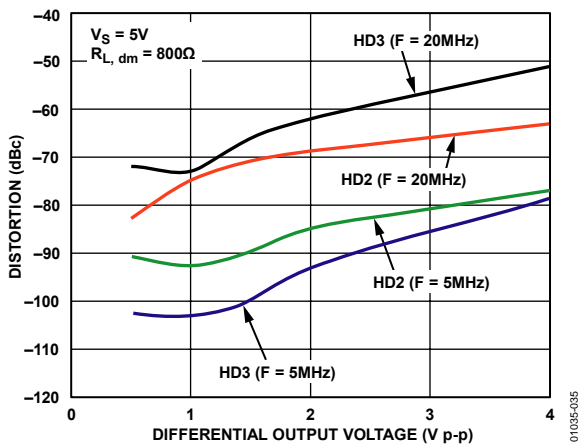

Figure 29. Harmonic Distortion vs. Differential Output Voltage, $G = 2$ (See Figure 63)

01035-035

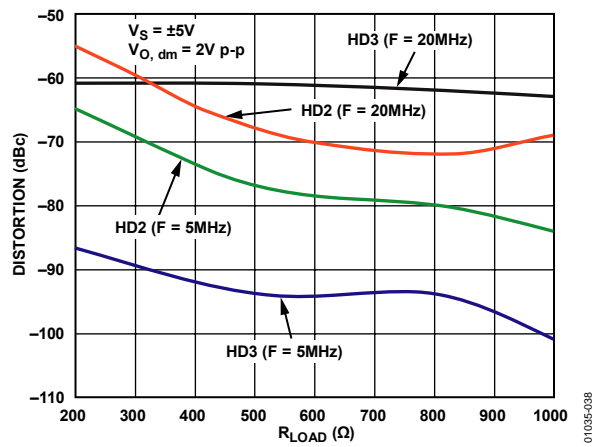

Figure 32. Harmonic Distortion vs. R_{LOAD} , $G = 2$ (See Figure 63)

01035-038

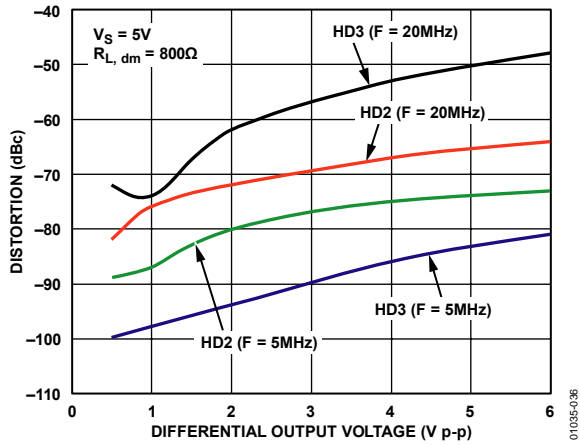

Figure 30. Harmonic Distortion vs. Differential Output Voltage, $G = 2$ (See Figure 63)

01035-036

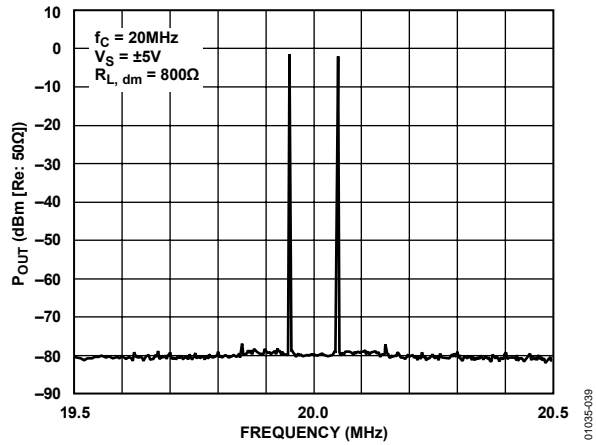

Figure 33. Intermodulation Distortion, $G = 1$

01035-039

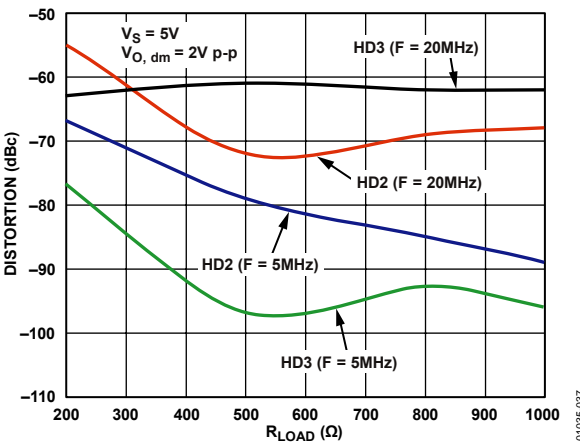

Figure 31. Harmonic Distortion vs. R_{LOAD} , $G = 2$ (See Figure 63)

01035-037

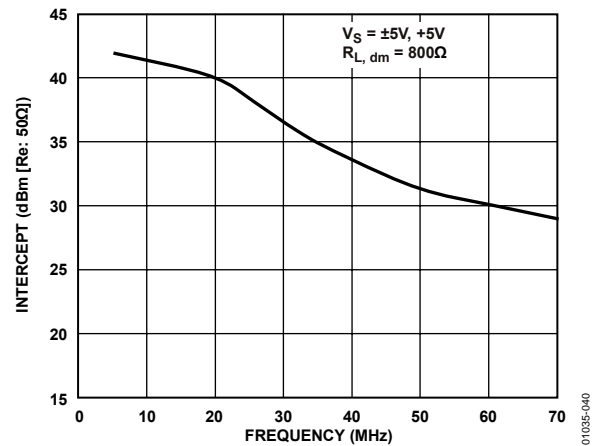

Figure 34. Third-Order Intercept vs. Frequency, $G = 1$

01035-040

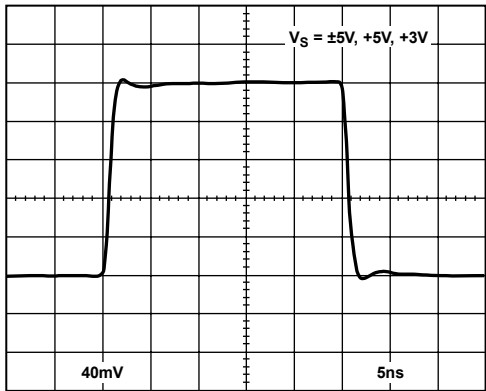

Figure 35. Small Signal Transient Response, $G = 1$

01035-041

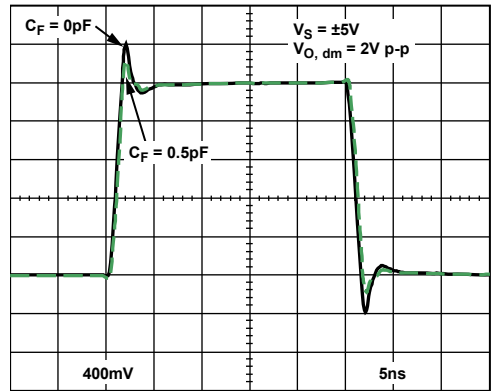

Figure 38. Large Signal Transient Response, $G = 1$

01035-044

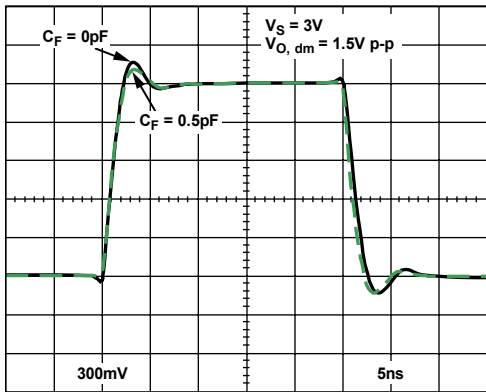

Figure 36. Large Signal Transient Response, $G = 1$

01035-042

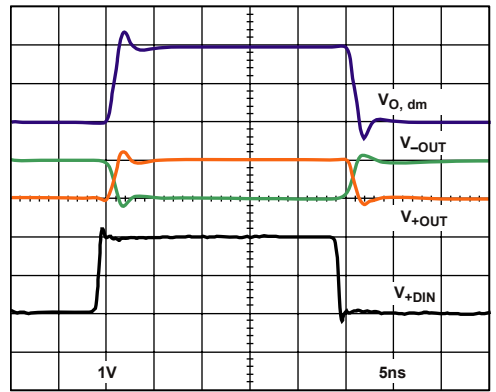

Figure 39. Large Signal Transient Response, $G = 1$

01035-045

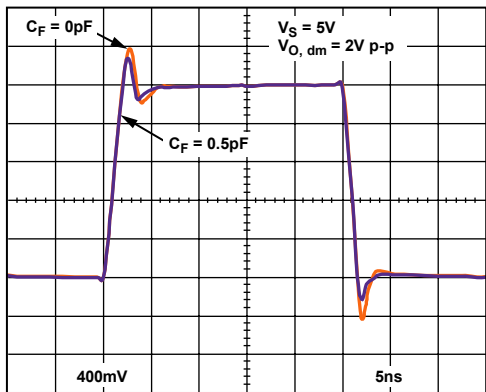

Figure 37. Large Signal Transient Response, $G = 1$

01035-043

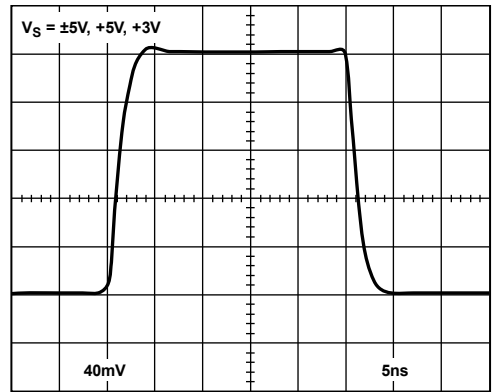

Figure 40. Small Signal Transient Response, $G = 2$

01035-046

AD8132

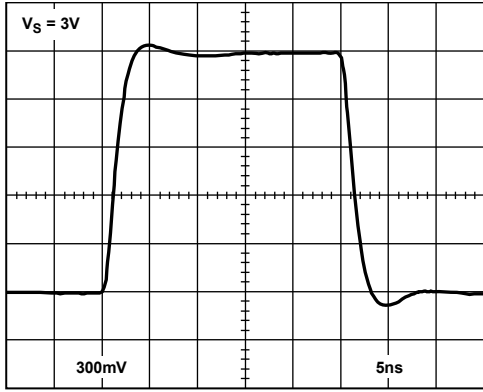

Figure 41. Large Signal Transient Response, $G = 2$

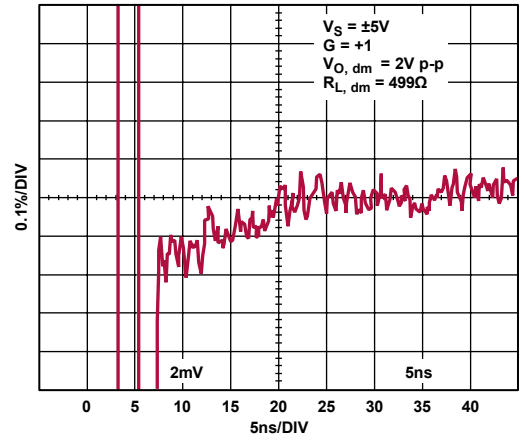

Figure 44. 0.1% Settling Time

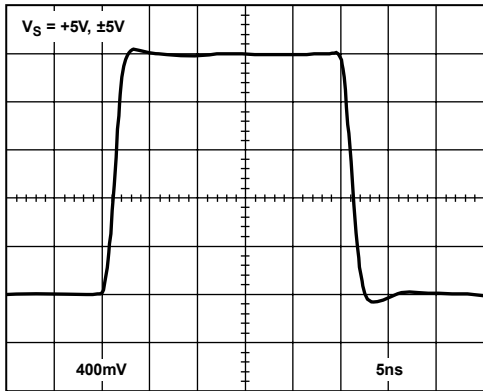

Figure 42. Large Signal Transient Response, $G = 2$

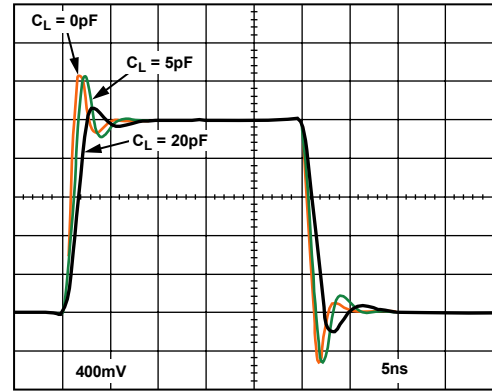

Figure 45. Large Signal Transient Response for Various Capacitor Loads (See Figure 60)

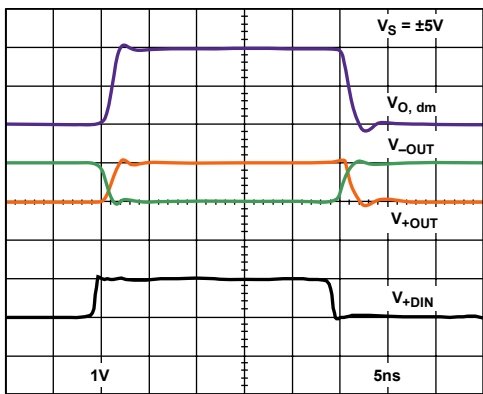

Figure 43. Large Signal Transient Response, $G = 2$

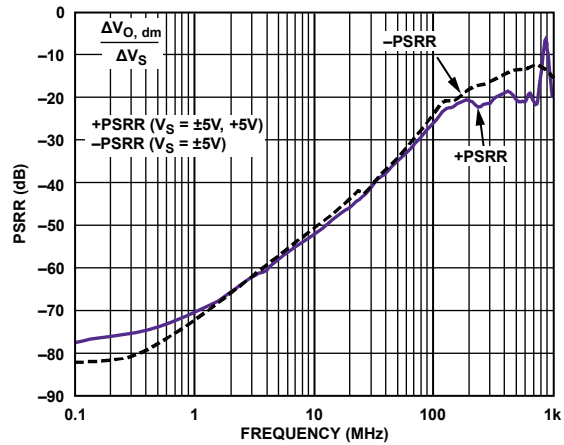

Figure 46. PSRR vs. Frequency

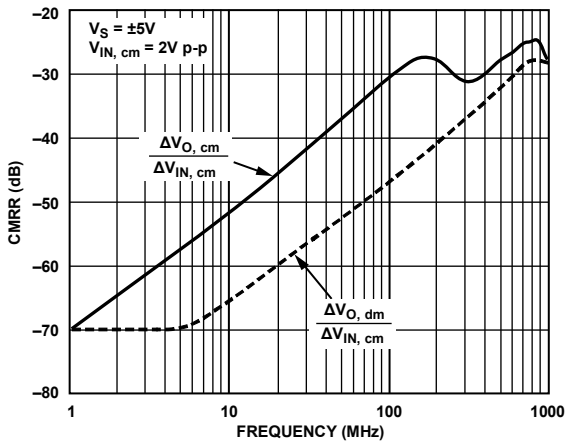

Figure 47. CMRR vs. Frequency (See Figure 61)

01035-055

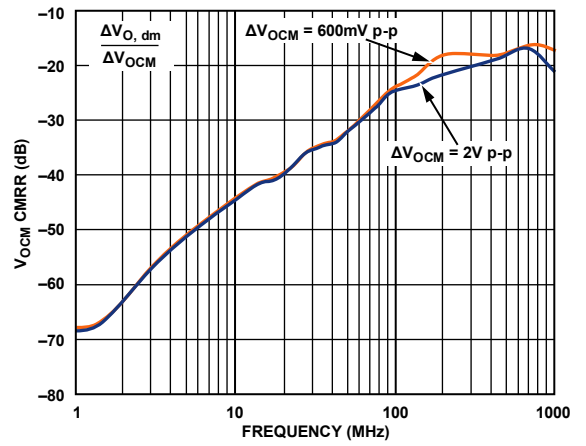

Figure 50. V_{OCM} CMRR vs. Frequency

01035-056

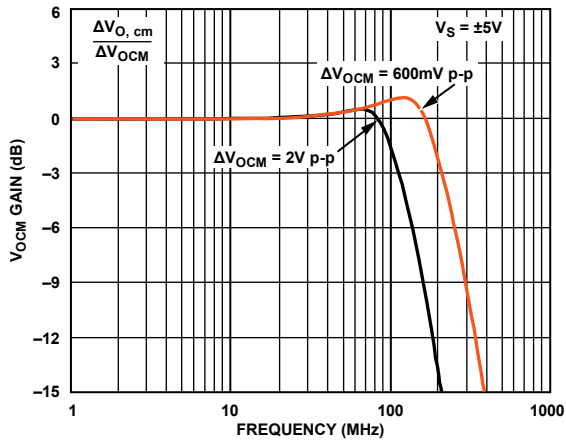

Figure 48. V_{OCM} Gain Response

01035-056

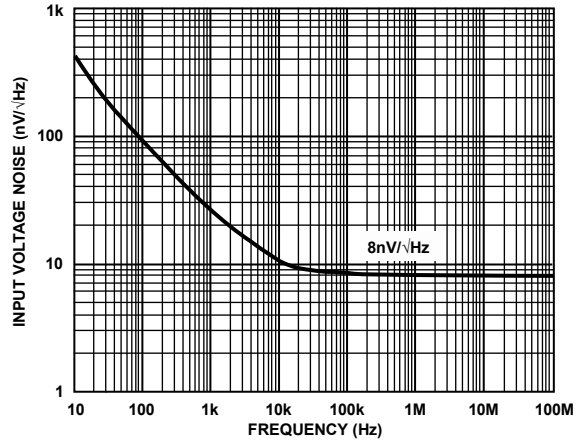

Figure 51. Input Voltage Noise vs. Frequency

01035-059

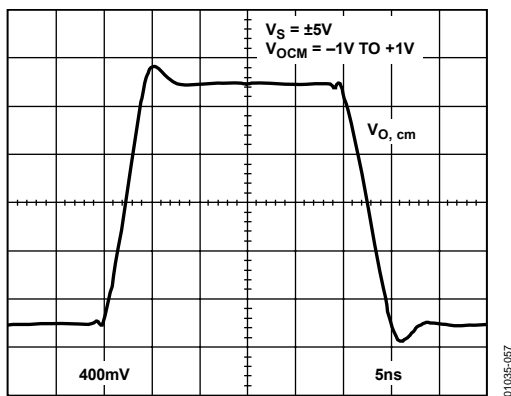

Figure 49. V_{OCM} Transient Response

01035-057

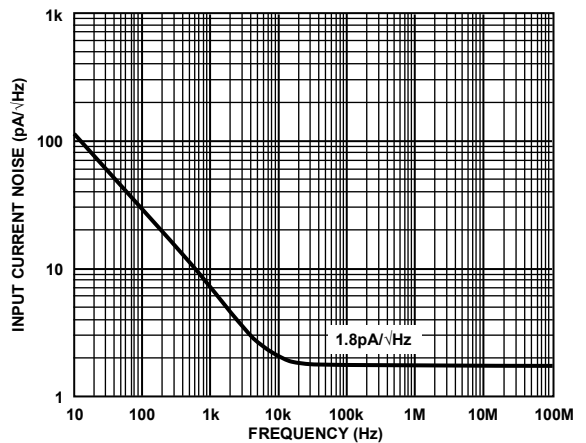

Figure 52. Input Current Noise vs. Frequency

01035-060

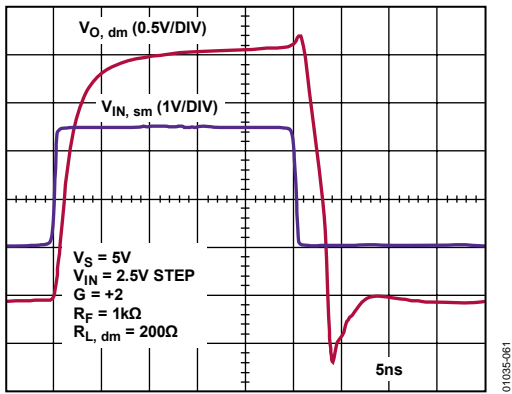

Figure 53. Overdrive Recovery

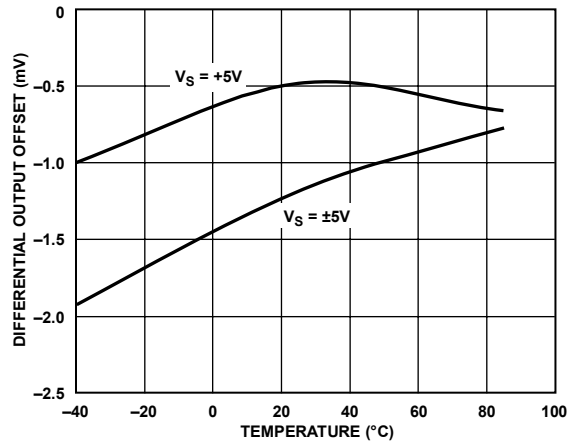

Figure 55. Differential Output Offset Voltage vs. Temperature

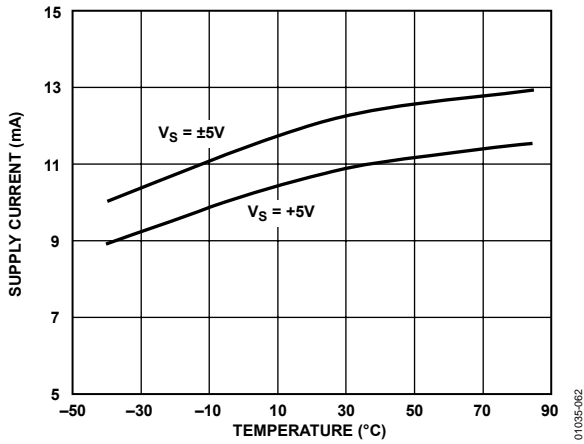

Figure 54. Quiescent Current vs. Temperature

TEST CIRCUITS

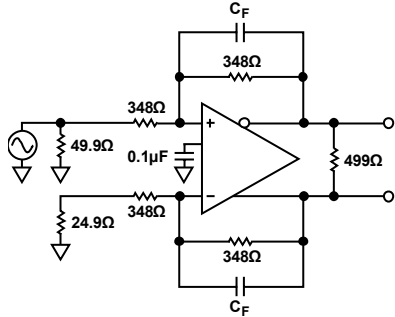
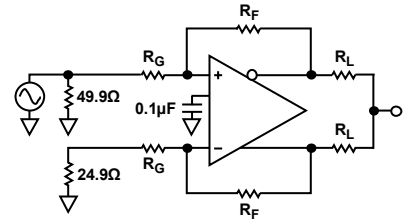

Figure 56. Basic Test Circuit, $G = 1$

01035-005



$G = +1$: $R_F = R_G = 348\Omega$, $R_L = 249\Omega$ ($R_{L, dm} = 498\Omega$)
 $G = +2$: $R_F = 1000\Omega$, $R_G = 499\Omega$, $R_L = 100\Omega$ ($R_{L, dm} = 200\Omega$)

01035-021

Figure 59. Test Circuit for Output Balance

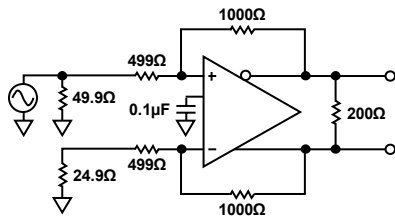

Figure 57. Basic Test Circuit, $G = 2$

01035-014

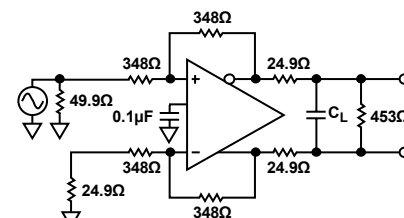

Figure 60. Test Circuit for Capacitor Load Drive

01035-051

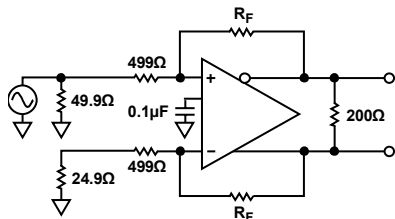
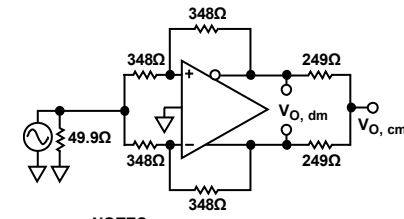

Figure 58. Test Circuit for Various Gains

01035-019



NOTES
 RESISTORS MATCHED TO 0.01%.

Figure 61. CMRR Test Circuit

01035-054

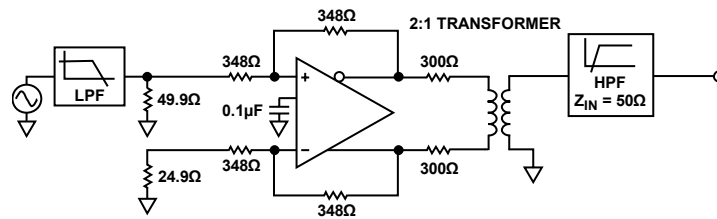

Figure 62. Harmonic Distortion Test Circuit, $G = 1$, $R_{L, dm} = 800\Omega$

01035-023

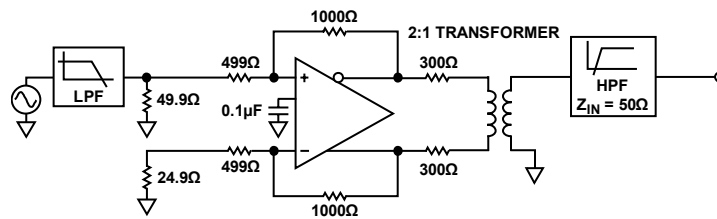

Figure 63. Harmonic Distortion Test Circuit, $G = 2$, $R_{L, dm} = 800\Omega$

01035-032

AD8132

OPERATIONAL DESCRIPTION

DEFINITION OF TERMS

Differential Voltage

The difference between two node voltages. For example, the output differential voltage (or equivalently output differential-mode voltage) is defined as

$$V_{OUT, dm} = (V_{+OUT} - V_{-OUT})$$

where V_{+OUT} and V_{-OUT} refer to the voltages at the +OUT and -OUT terminals with respect to a common reference.

Common-Mode Voltage

The average of two node voltages. The output common-mode voltage is defined as

$$V_{OUT, cm} = (V_{+OUT} + V_{-OUT})/2$$

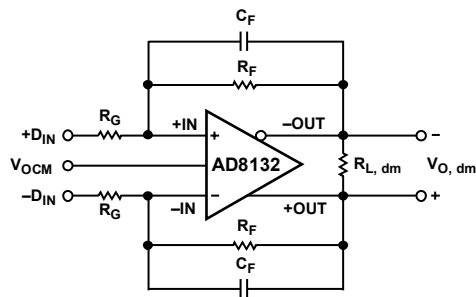

Figure 64. Circuit Definitions

BASIC CIRCUIT OPERATION

One of the more useful and easy to understand ways to use the AD8132 is to provide two equal-ratio feedback networks. To match the effect of parasitics, comprise these networks of two equal-value feedback resistors (R_F) and two equal-value gain resistors (R_G). This circuit is shown in Figure 64.

Like a conventional op amp, the AD8132 has two differential inputs that can be driven with both differential-mode input voltage ($V_{IN, dm}$) and common-mode input voltage ($V_{IN, cm}$).

There is another input (V_{OCM}) that is not present on conventional op amps, but provides another input to consider on the AD8132. It is totally separate from the previous inputs.

There are two complementary outputs whose response can be defined by a differential-mode output ($V_{OUT, dm}$) and a common-mode output ($V_{OUT, cm}$).

Table 10 indicates the gain from any type of input to either type of output.

Table 10. Differential and Common-Mode Gains

Input	$V_{OUT, dm}$	$V_{OUT, cm}$
$V_{IN, dm}$	R_F/R_G	0 (by design)
$V_{IN, cm}$	0	0 (by design)
V_{OCM}	0	1 (by design)

As listed in Table 10, the differential output ($V_{OUT, dm}$) is equal to the differential input voltage ($V_{IN, dm}$) times R_F/R_G . In this case, it does not matter if both differential inputs are driven, or only one output is driven and the other is tied to a reference voltage, such as ground. As seen from the two zero entries in the $V_{OUT, dm}$ column, neither of the common-mode inputs has any effect on this gain.

The gain from $V_{IN, dm}$ to $V_{OUT, cm}$ is 0, and first-order does not depend on the ratio matching of the feedback networks. The common-mode feedback loop within the AD8132 provides a corrective action to keep this gain term minimized. The term balance error describes the degree that this gain term differs from 0.

The gain from $V_{IN, cm}$ to $V_{OUT, dm}$ directly depends on the matching of the feedback networks. The analogous term for this transfer function (used in conventional op amps) is common-mode rejection ratio (CMRR). Therefore, if it has a high CMRR, the feedback ratios must be well matched.

The gain from $V_{IN, cm}$ to $V_{OUT, cm}$ is ideally 0 and is first-order independent of the feedback ratio matching. As in the case of $V_{IN, dm}$ to $V_{OUT, cm}$, the common-mode feedback loop keeps this term minimized.

The gain from V_{OCM} to $V_{OUT, dm}$ is ideally 0 when the feedback ratios are matched only. The amount of differential output signal that is created by varying V_{OCM} is related to the degree of mismatch in the feedback networks.

V_{OCM} controls the output common-mode voltage $V_{OUT, cm}$ with a unity-gain transfer function. With equal-ratio feedback networks (as previously assumed), its effect on each output is the same, that is the gain from V_{OCM} to $V_{OUT, dm}$ is 0. If not driven, the output common-mode voltage is set with an internal voltage divider to a level that is nominally midsupply. It is recommended that a 0.1 μ F bypass capacitor be connected to V_{OCM} .

When unequal feedback ratios are used, the two gains associated with $V_{OUT, dm}$ become nonzero. This significantly complicates the mathematical analysis along with any intuitive understanding of how the part operates.

THEORY OF OPERATION

The AD8132 differs from conventional op amps by the external presence of an additional input and output. The additional input, V_{OCM} , controls the output common-mode voltage. The additional output is the analog complement of the single output of a conventional op amp. For its operation, the AD8132 uses two feedback loops as compared to the single loop of conventional op amps. Although this provides significant freedom to create various novel circuits, basic op amp theory can still be used to analyze the operation.

One of the feedback loops controls the output common-mode voltage, $V_{OUT,cm}$. Its input is V_{OCM} (Pin 2) and the output is the common-mode, or average voltage, of the two differential outputs (+OUT and -OUT). The gain of this circuit is internally set to unity. When the AD8132 is operating in its linear region, this establishes one of the operational constraints: $V_{OUT,cm} = V_{OCM}$.

The second feedback loop controls the differential operation. Similar to an op amp, the gain and gain shaping of the transfer function can be controlled by adding passive feedback networks. However, only one feedback network is required to close the loop and fully constrain the operation, but depending on the function desired, two feedback networks can be used. This is possible because there are two outputs that are each inverted with respect to the differential inputs.

GENERAL USAGE OF THE AD8132

Several assumptions are made here for a first-order analysis; they are the typical assumptions used for the analysis of op amps:

- The input bias currents are sufficiently small so they can be neglected.
- The output impedances are arbitrarily low.
- The open-loop gain is arbitrarily large, and drives the amplifier to a state where the input differential voltage is effectively 0.
- Offset voltages are assumed to be 0.

Though it is possible to operate the AD8132 with a purely differential input, many of its applications call for a circuit that has a single-ended input with a differential output.

For a single-ended-to-differential circuit, the R_G of the input that is not driven is tied to a reference voltage. This is ground. Other conditions are discussed in the following sections. In addition, the voltage at V_{OCM} , and therefore $V_{OUT,cm}$, is assumed to be ground. Figure 67 shows a generalized schematic of such a circuit using an AD8132 with two feedback paths.

For each feedback network, a feedback factor can be defined as the fraction of the output signal that is fed back to the opposite sign input. These terms are

$$\beta_1 = R_{G1} / (R_{G1} + R_{F1})$$

$$\beta_2 = R_{G2} / (R_{G2} + R_{F2})$$

The feedback factor, β_1 , is for the side that is driven, and the feedback factor, β_2 , is for the side that is tied to a reference voltage (ground). Note that each feedback factor can vary anywhere between 0 and 1.

A single-ended-to-differential gain equation can be derived (this is true for all values of β_1 and β_2):

$$G = \frac{2(1 - \beta_1)}{(\beta_1 + \beta_2)}$$

This expression is not very intuitive, but some further examples can provide better understanding of its implications. One observation that can be made immediately is that a tolerance error in β_1 does not have the same effect on gain as the same tolerance error in β_2 .

DIFFERENTIAL AMPLIFIER WITHOUT RESISTORS (HIGH INPUT IMPEDANCE INVERTING AMPLIFIER)

The simplest closed-loop circuit that can be made does not require any resistors and is shown in Figure 70. In this circuit, β_1 is equal to 0, and β_2 is equal to 1. The gain is equal to 2.

A more intuitive method to figure the gain is by simple inspection. +OUT is connected to -IN, whose voltage is equal to the voltage at +IN under equilibrium conditions. Thus, +V_{OUT} is equal to V_{IN}, and there is unity gain in this path. Because -OUT has to swing in the opposite direction from +OUT due to the common-mode constraint, its effect doubles the output signal and produces a gain of 2.

One useful function that this circuit provides is a high input impedance inverter. If +OUT is ignored, there is a unity-gain, high input impedance amplifier formed from +IN to -OUT. Most traditional op amp inverters have relatively low input impedances, unless they are buffered with another amplifier.

V_{OCM} is assumed to be at midsupply. Because there is still the constraint that +V_{OUT} must equal V_{IN}, changing the V_{OCM} voltage does not change +V_{OUT} (equal to V_{IN}). Therefore, the effect of changing V_{OCM} must show up at -OUT.

For example, if V_{OCM} is raised by 1 V, then -V_{OUT} must increase by 2 V. This makes $V_{OUT,cm}$ also increase by 1 V, because it is defined as the average of the two differential output voltages. This means that the gain from V_{OCM} to the differential output is 2.

AD8132

OTHER $\beta_2 = 1$ CIRCUITS

The preceding simple configuration with $\beta_2 = 1$ and its gain of 2 is the highest gain circuit that can be made under this condition. Since β_1 was equal to 0, only higher β_1 values are possible. The circuits with higher values of β_1 have gains lower than 2. However, circuits with β_1 equal to 1 are not practical because they have no effective input and result in a gain of 0.

To increase β_1 from 0, it is necessary to add two resistors in a feedback network. A generalized circuit that has β_1 with a value higher than 0 is shown in Figure 69. A couple of different convenient gains that can be created are a gain of 1, when β_1 is equal to 1/3, and a gain of 0.5, when β_1 equals 0.6.

With β_2 equal to 1 in these circuits, V_{OCM} serves as the reference voltage that measures the input voltage and the individual output voltages. In general, when V_{OCM} is varied in circuits with unmatched feedback networks, a differential output signal is generated that is proportional to the applied V_{OCM} voltage.

VARYING β_2

Though the $\beta_2 = 1$ circuit sets β_2 to 1, another class of simple circuits can be made that sets β_2 equal to 0. This means that there is no feedback from +OUT to -IN. This class of circuits is very similar to a conventional inverting op amp. However, the AD8132 circuits have an additional output and common-mode input that can be analyzed separately (see Figure 71).

With -IN connected to ground, +IN becomes a virtual ground in the sense that the term is used for conventional op amps. Both inputs must maintain the same voltage for equilibrium operation; therefore, if one is set to ground, the other is driven to ground. The input impedance can also be seen to be equal to R_G , just as in a conventional op amp.

In this case, however, the positive input and negative output are used for the feedback network. Because a conventional op amp does not have a negative output, only its inverting input can be used for the feedback network. The AD8132 is symmetrical, therefore, the feedback network on either side can be used to produce the same results.

Because +IN is a summing junction, by an analogy to conventional op amps, the gain from V_{IN} to -OUT is $-R_F/R_G$. This holds true regardless of the voltage on V_{OCM} , and since +OUT moves the same amount in the opposite direction from -OUT, the overall gain is $-2(R_F/R_G)$.

V_{OCM} still governs $V_{OUT,cm}$, so +OUT must be the only output that moves when V_{OCM} is varied. Because $V_{OUT,cm}$ is the average of the two outputs, +OUT must move twice as far and in the same direction as V_{OCM} to create the proper $V_{OUT,cm}$. Therefore, the gain from V_{OCM} to +OUT must be 2.

With β_2 equal to 0 in these circuits, the gain can theoretically be set to any value from close to 0 to infinity, just as it can with a conventional op amp in the inverting mode. However, practical real-world limitations and parasitics limit the range of acceptable gain to more modest values.

$\beta_1 = 0$

There is yet another class of circuits where there is no feedback from -OUT to +IN. This is the case where $\beta_1 = 0$. The differential amplifier without a resistor described in the Differential Amplifier Without Resistors (High Input Impedance Inverting Amplifier) section meets this condition, but it was presented only with the condition that $\beta_2 = 1$. Recall that this circuit had a gain equal to 2.

If β_2 decreases in this circuit from unity, a smaller part of + V_{OUT} is fed back to -IN and the gain increases (see Figure 68). This circuit is very similar to a noninverting op amp configuration, except for the presence of the additional complementary output. Therefore, the overall gain is twice that of a noninverting op amp or $2 \times (1 + R_{F2}/R_{G2})$ or $2 \times (1/\beta_2)$.

Once again, varying V_{OCM} does not affect both outputs in the same way; therefore, in addition to varying $V_{OUT,cm}$ with unity gain, there is also an effect on $V_{OUT,dm}$ by changing V_{OCM} .

ESTIMATING THE OUTPUT NOISE VOLTAGE

Similar to the case of a conventional op amp, the differential output errors (noise and offset voltages) can be estimated by multiplying the input referred terms, at +IN and -IN, by the circuit noise gain. The noise gain is defined as

$$G_N = 1 + \left(\frac{R_F}{R_G} \right)$$

To compute the total output referred noise for the circuit of Figure 64, consideration must be given to the contribution of resistors, R_F and R_G . See Table 11 for estimated output noise voltage densities at various closed-loop gains.

Table 11. Recommended Resistor Values and Noise Performance for Specific Gains

Gain	R_G (Ω)	R_F (Ω)	Bandwidth -3 dB (MHz)	Output Noise AD8132 Only (nV/ \sqrt{Hz})	Output Noise AD8132 + R_G, R_F (nV/ \sqrt{Hz})
1	499	499	360	16	17
2	499	1.0 k	160	24.1	26.1
5	499	2.49 k	65	48.4	53.3
10	499	4.99 k	20	88.9	98.6

When using the AD8132 in gain configurations where $\beta_1 \neq \beta_2$, differential output noise appears due to input-referred voltage noise in the V_{OCM} circuitry according to the following formula:

$$V_{OND} = 2 V_{NOCM} \left[\frac{\beta_1 - \beta_2}{\beta_1 + \beta_2} \right]$$

where V_{OND} is the output differential noise and V_{NOCM} is the input-referred voltage noise on V_{OCM} .

CALCULATING INPUT IMPEDANCE OF THE APPLICATION CIRCUIT

The effective input impedance of a circuit, such as that in Figure 64, at $+D_{IN}$ and $-D_{IN}$, depends on whether the amplifier is being driven by a single-ended or differential signal source. For balanced differential input signals, the input impedance ($R_{IN, dm}$) between the inputs ($+D_{IN}$ and $-D_{IN}$) is simply

$$R_{IN, dm} = 2 \times R_G$$

In the case of a single-ended input signal (for example, if $-D_{IN}$ is grounded and the input signal is applied to $+D_{IN}$), the input impedance becomes

$$R_{IN, dm} = \left(\frac{R_G}{1 - \frac{R_G}{2 \times (R_G + R_F)}} \right)$$

The circuit input impedance is effectively higher than it would be for a conventional op amp connected as an inverter because a fraction of the differential output voltage appears at the inputs as a common-mode signal, partially bootstrapping the voltage across the Input Resistor R_G .

INPUT COMMON-MODE VOLTAGE RANGE IN SINGLE-SUPPLY APPLICATIONS

The AD8132 is optimized for level-shifting ground-referenced input signals. For a single-ended input, this implies that the voltage at $-D_{IN}$ in Figure 64 is 0 V when the amplifier’s negative power supply voltage (at $V-$) was also set to 0 V.

SETTING THE OUTPUT COMMON-MODE VOLTAGE

The AD8132s V_{OCM} pin is internally biased at a voltage approximately equal to the midsupply point (average value of the voltage on $V+$ and $V-$). Relying on this internal bias results in an output common-mode voltage that is within approximately 100 mV of the expected value.

In cases where more accurate control of the output common-mode level is required, it is best practice that an external source or resistor divider (with $R_{SOURCE} < 10 \text{ k}\Omega$) be used. The output common-mode

offset values in the Specifications section assume the V_{OCM} input is driven by a low impedance voltage source.

DRIVING A CAPACITIVE LOAD

A purely capacitive load can react with the pin and bond wire inductance of the AD8132, resulting in high frequency ringing in the pulse response. One way to minimize this effect is to place a small capacitor across each of the feedback resistors. The added capacitance must be small to avoid destabilizing the amplifier. An alternative technique is to place a small resistor in series with the amplifier outputs, as shown in Figure 60.

OPEN-LOOP GAIN AND PHASE

Open-loop gain and phase plots are shown in Figure 65 and Figure 66.

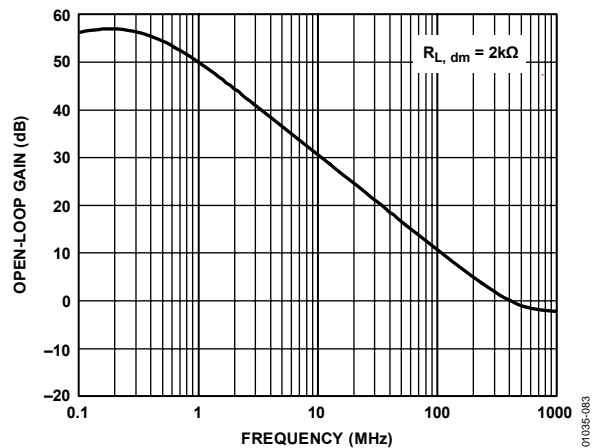

Figure 65. Open-Loop Gain Plot

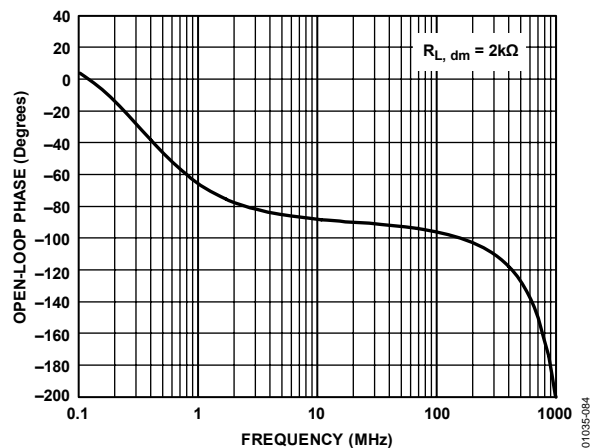

Figure 66. Open-Loop Phase Plot

AD8132

LAYOUT, GROUNDING, AND BYPASSING

As a high speed part, the AD8132 is sensitive to the PCB environment in which it operates. Realizing its superior specifications requires attention to various details of good high speed PCB design.

The first requirement is a good solid ground plane that covers as much of the board area around the AD8132 as possible. The only exception to this is that the two input pins (Pin 1 and Pin 8) are kept a few millimeters from the ground plane and that ground be removed from inner layers and the opposite side of the board under the input pins. This minimizes the stray capacitance on these nodes and helps preserve the gain flatness vs. the frequency.

Bypass the power supply pins as close as possible to the device to the nearby ground plane and use good high frequency ceramic chip capacitors. Do this bypassing with a capacitance value of 0.01 μF to 0.1 μF for each supply. Farther away, provide low frequency bypassing with 10 μF tantalum capacitors from each supply to ground.

Keep the signal routing short and direct to avoid parasitic effects. Wherever there are complementary signals, a symmetrical layout with matched lengths must be provided to the extent possible to maximize the balance performance. When running differential signals over a long distance, place the traces on the PCB close together or twist together any differential wiring to minimize the area of the loop that is formed. This reduces the radiated energy and makes the circuit less susceptible to interference.

CIRCUITS

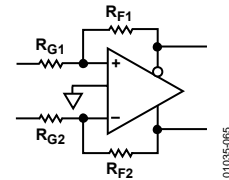

Figure 67. Typical Four-Resistor Feedback Circuit

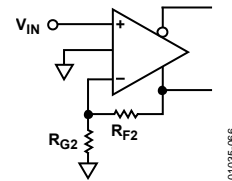

Figure 68. Typical Circuit with $\beta_1 = 0$

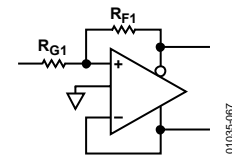

Figure 69. Typical Circuit with $\beta_2 = 1$

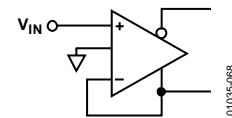

Figure 70. $G = 2$ Circuit with $\beta_1 = 0$, Without Resistors

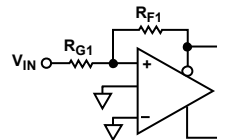

Figure 71. Typical Circuit with $\beta_2 = 0$

APPLICATIONS

ANALOG-TO-DIGITAL DRIVER

Many of the newer high speed ADCs are single-supply and have differential inputs. Thus, the driver for these devices is able to convert from a single-ended signal to a differential signal and provide output common-mode level shifting in addition to having low distortion and noise. The AD8132 conveniently performs these functions when driving the AD9203, a 10-bit, 40 MSPS ADC.

In Figure 73, a 1 V p-p signal drives the input of an AD8132 configured for unity gain. Both the AD8132 and the AD9203 are powered from a single 3 V supply. A voltage divider biases V_{OCM} at midsupply and in turn drives $V_{OUT,cm}$ to half of the supply voltage. This is within the common-mode range of the AD9203.

Between the ADC and the driver is a 1-pole, differential filter that helps to filter some of the noise and assists the switched-capacitor inputs of the ADC. Each of the ADC inputs is driven by a 0.5 V p-p signal that ranges from 1.25 V dc to 1.75 V dc. Figure 72 is an

FFT plot of the performance of the circuit when running at a clock rate of 40 MSPS and an input frequency of 2.5 MHz.

BALANCED CABLE DRIVER

When driving a twisted pair cable, it is desirable to drive only a pure differential signal onto the line. If the signal is purely differential (that is, fully balanced), and the transmission line is twisted and balanced, there is minimum radiation of any signal.

The complementary electrical fields are confined mostly to the space between the two twisted conductors and does not significantly radiate out from the cable. The current in the cable creates magnetic fields that radiate to some degree. However, the amount of radiation is mitigated by the twists, because for each twist, the two adjacent twists have an opposite polarity magnetic field. If the twist pitch is tight enough, these small magnetic field loops contain most of the magnetic flux, and the magnetic farfield strength is negligible.

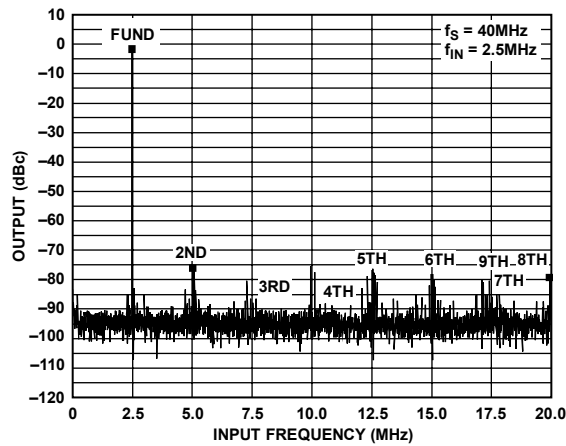

Figure 72. FFT Response for AD8132 Driving AD9203

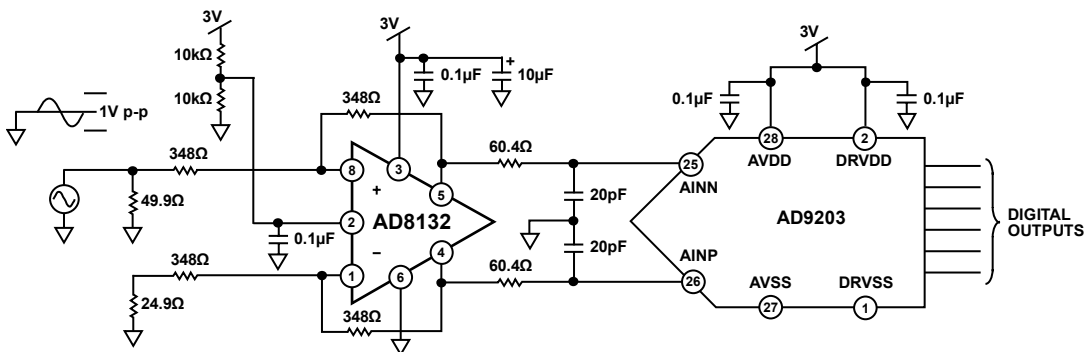

Figure 73. AD8132 Driving AD9203, a 10-Bit, 40 MSPS ADC

AD8132

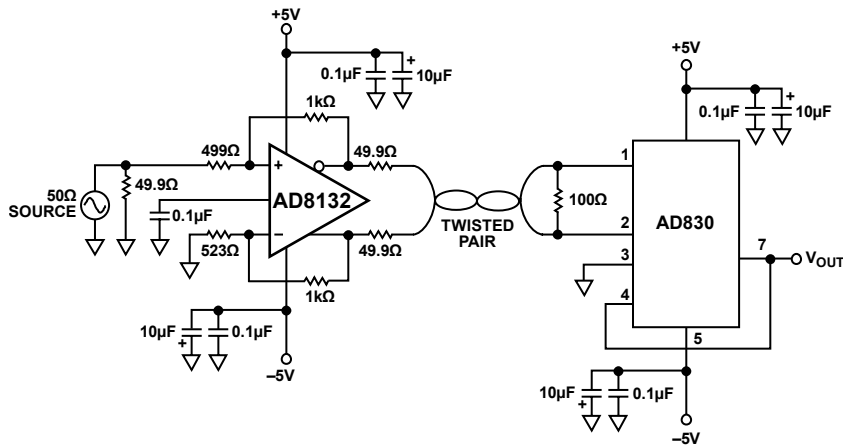

Figure 74. Balanced Line Driver and Receiver Using AD8132 and AD830

Any imbalance in the differential drive signal appears as a common-mode signal on the cable. This is the equivalent of a single wire that is driven with the common-mode signal. In this case, the wire acts as an antenna and radiates. Thus, to minimize radiation when driving differential twisted pair cables, make sure the differential drive signal is well balanced.

The common-mode feedback loop in the AD8132 helps to minimize the amount of common-mode voltage at the output, and can therefore be used to create a well-balanced differential line driver. Figure 74 shows an application that uses an AD8132 as a balanced line driver and an AD830 as a differential receiver configured for unity gain. This circuit was operated with 10 meters of Category 5 cable.

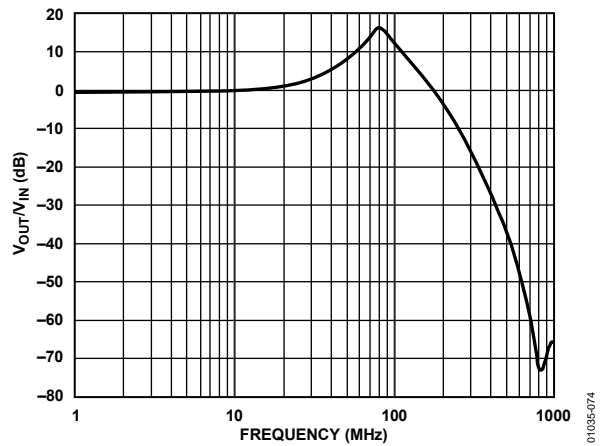

Figure 76. Frequency Response for Transmit Boost Circuit

TRANSMIT EQUALIZER

Any length of transmission line attenuates the signals it carries. This effect is worse at higher frequencies than at lower frequencies. One way to compensate for this is to provide an equalizer circuit that boosts the higher frequencies in the transmitter circuit, so that at the receive end of the cable, the attenuation effects are diminished.

By lowering the impedance of the R_G component of the feedback network at a higher frequency, the gain can be increased at a high frequency. Figure 75 shows the gain of a two-line driver that has its R_G resistors shunted by 10 pF capacitors. The effect of this is shown in the frequency response plot of Figure 76.

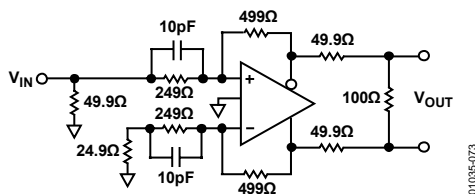

Figure 75. Frequency Boost Circuit

LOW-PASS DIFFERENTIAL FILTER

Similar to an op amp, various types of active filters can be created with the AD8132. These can have single-ended inputs and differential outputs that can provide an antialias function when driving a differential ADC.

Figure 77 is a schematic of a low-pass, multiple feedback filter. The active section contains two poles, and an additional pole is added at the output. The filter was designed to have a -3 dB frequency of 1 MHz. The actual -3 dB frequency was measured to be 1.12 MHz, as shown in Figure 78.

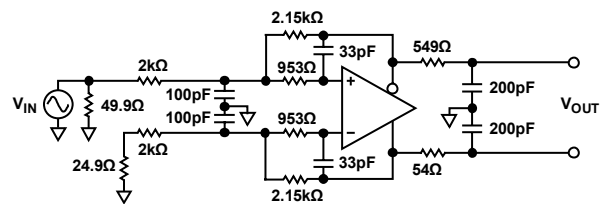

Figure 77. 1 MHz, 3-Pole Differential Output, Low-Pass, Multiple Feedback Filter

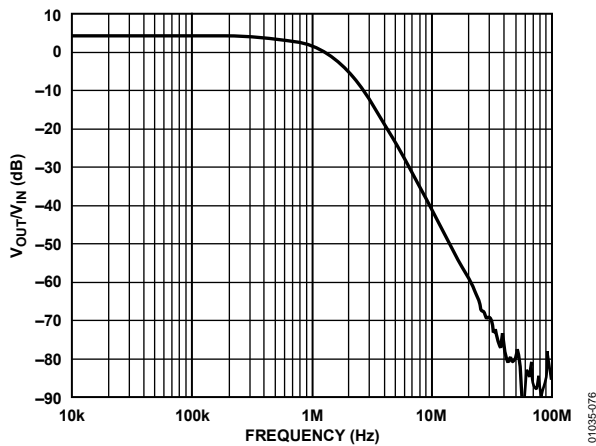

Figure 78. Frequency Response of 1 MHz Low-Pass Filter

HIGH COMMON-MODE OUTPUT IMPEDANCE AMPLIFIER

Changing the connection to V_{OCM} (Pin 2) can change the common-mode from low impedance to high impedance. If V_{OCM} is actively set to a particular voltage, the AD8132 tries to force $V_{OUT,cm}$ to the same voltage with a relatively low output impedance. All the previous analysis assumed that this output impedance is arbitrarily low enough to drive the load condition in the circuit.

However, there are some applications that benefit from a high common-mode output impedance. This is accomplished with the circuit shown in Figure 79.

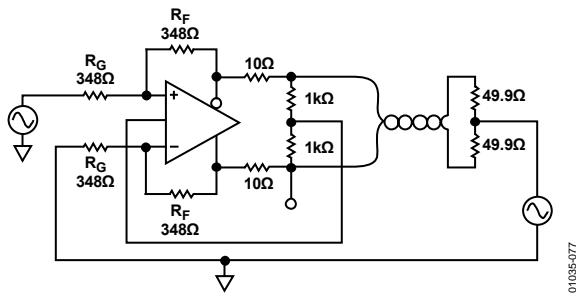

Figure 79. High Common-Mode, Output Impedance, Differential Amplifier

V_{OCM} is driven by a resistor divider that measures the output common-mode voltage. Thus, the common-mode output voltage takes on the value that is set by the driven circuit. In this case, it comes from the center point of the termination at the receive end of a 10 meter length of Category 5 twisted pair cable.

If the receive end common-mode voltage is set to ground, it is well defined at the receive end. Any common-mode signal that is picked up over the cable length due to noise appears at the transmit end and must be absorbed by the transmitter. Thus, it is important that the transmitter have adequate common-mode output range to absorb the full amplitude of the common-mode signal coupled onto the cable and therefore prevent clipping.

Another way to look at this is that the circuit performs what is sometimes called transformer action. One main difference is that the AD8132 passes dc while transformers do not.

A transformer can also be easily configured to have either a high or low common-mode output impedance. If the transformer's center tap is connected to a solid voltage reference, it sets the common-mode voltage on the secondary side of the transformer. In this case, if one of the differential outputs is grounded, the other output has half of the differential output signal. This keeps the common-mode voltage at ground, where it is required to be due to the center tap connection. This is analogous to the AD8132 operating with a low output impedance common-mode (see Figure 80).

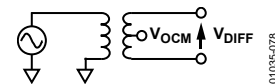

Figure 80. Transformer with Low Output Impedance Secondary Set at V_{OCM}

If the center tap of the secondary of a transformer is allowed to float as shown in Figure 81 (or if there is no center tap), the transformer has a high common-mode output impedance. This means that the common mode of the secondary is determined by what it is connected to and not by anything to do with the transformer itself.

If one of the differential ends of the transformer is grounded, the other end swings with the full output voltage. This means that the common mode of the output voltage is one-half of the differential output voltage. However, this shows that the common mode is not forced via a low impedance to a given voltage. The common-mode output voltage can be easily changed to any voltage through its other output terminals.

The AD8132 can exhibit the same performance when one of the outputs in Figure 79 is grounded. The other output swings at the full differential output voltage. The common-mode signal is measured by the voltage divider across the outputs and input to V_{OCM} . This, then, drives $V_{OUT,cm}$ to the same level. At higher frequencies, it is important to minimize the capacitance on the V_{OCM} node; otherwise, phase shifts can compromise the performance. The voltage divider resistances can also be lowered for better frequency response.

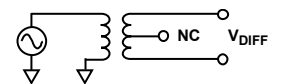

Figure 81. Transformer with High Output Impedance Secondary

AD8132

FULL-WAVE RECTIFIER

The balanced outputs of the AD8132, along with a couple of Schottky diodes, can create a very high speed, full-wave rectifier. Such circuits are useful for measuring ac voltages and other computational tasks.

Figure 82 shows the configuration of such a circuit. Each of the AD8132 outputs drives the anode of an HP2835 Schottky diode. These Schottky diodes were chosen for their high speed operation. At lower frequencies (approximately lower than 10 MHz), a silicon signal diode, such as a 1N4148, can be used. The cathodes of the two diodes are connected together, and this output node is connected to ground by a 100 Ω resistor.

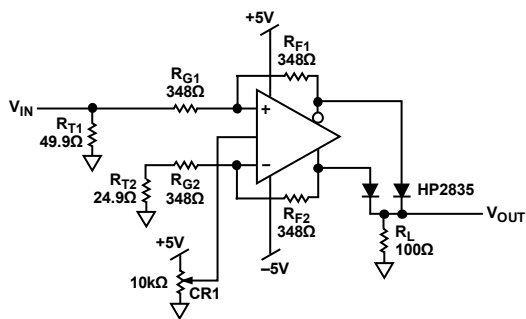

Figure 82. Full-Wave Rectifier

Operate the diodes such that they are slightly forward-biased when the differential output voltage is 0. For the Schottky diodes, this is approximately 400 mV. The forward biasing is conveniently adjusted by CR1, which, in this circuit, raises and lowers $V_{OUT,cm}$ without creating a differential output voltage.

One advantage of this circuit is that the feedback loop is never momentarily opened while the diodes reverse their polarity within the loop. This scheme is sometimes used for full-wave rectifiers that use conventional op amps. These conventional circuits do not work well at frequencies above approximately 1 MHz.

If there is not enough forward bias ($V_{OUT,cm}$ too low), the lower sharp cusps of the full-wave rectified output waveform are rounded off. In addition, as the frequency increases, there tends to be some rounding of the lower cusps. The forward bias can be increased to yield sharper cusps at higher frequencies.

There is not a reliable, entirely quantifiable means to measure the performance of a full-wave rectifier. Since the ideal waveform has periodic sharp discontinuities, it has (mostly even) harmonics that have no upper bound on the frequency. However, for a practical circuit, as the frequency increases, the higher harmonics become attenuated and the sharp cusps that are present at low frequencies become significantly rounded.

When running the circuit at a frequency up to 300 MHz, though it stays functional, the major harmonic that remains in the output is the second. This looks like a sine wave at 600 MHz. Figure 83 is an oscilloscope plot of the output when driven by a 100 MHz, 2.5 V p-p input.

Sometimes a second harmonic generator is useful for creating a clock to oversample a DAC by a factor of two. If the output of this circuit is run through a low-pass filter, it can be used as a second harmonic generator.

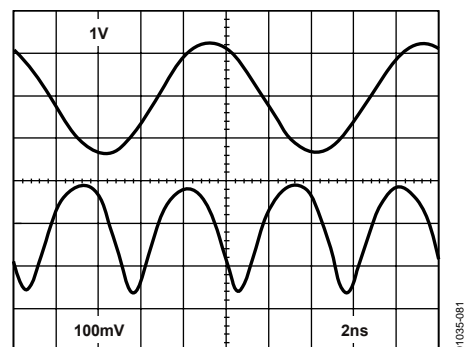
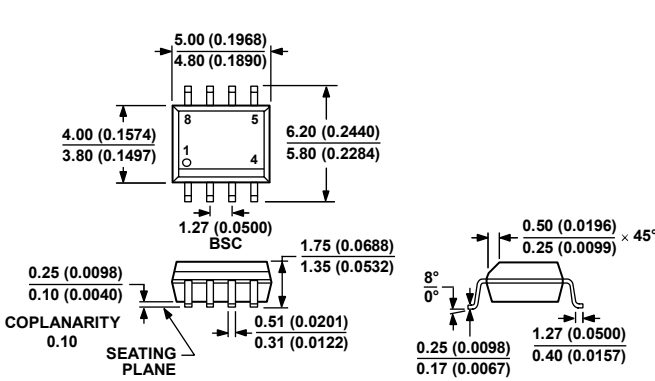

Figure 83. Full-Wave Rectifier Response with 100 MHz Input

OUTLINE DIMENSIONS



COMPLIANT TO JEDEC STANDARDS MS-012-AA
 CONTROLLING DIMENSIONS ARE IN MILLIMETERS; INCH DIMENSIONS (IN PARENTHESES) ARE ROUNDED-OFF MILLIMETER EQUIVALENTS FOR REFERENCE ONLY AND ARE NOT APPROPRIATE FOR USE IN DESIGN.

Figure 84. 8-Lead Standard Small Outline Package [SOIC_N] Narrow Body (R-8)
 Dimensions shown in millimeters and (inches)

060806-A

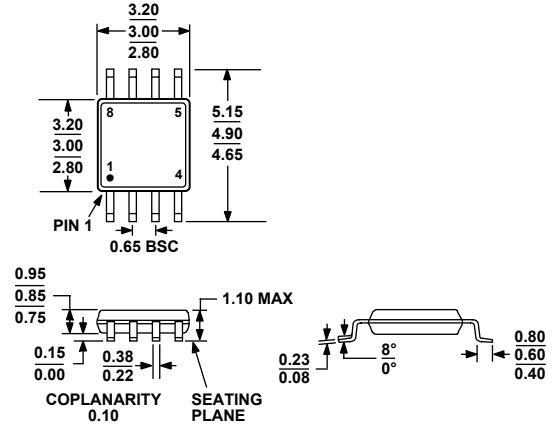

COMPLIANT TO JEDEC STANDARDS MO-187-AA

Figure 85. 8-Lead Mini Small Outline Package [MSOP] (RM-8)
 Dimensions shown in millimeters

ORDERING GUIDE

Model	Temperature Range	Package Description	Package Option	Branding	Ordering Quantity
AD8132AR	-40°C to +125°C	8-Lead SOIC_N	R-8		
AD8132AR-REEL	-40°C to +125°C	8-Lead SOIC_N, 13" Tape and Reel	R-8		2,500
AD8132AR-REEL7	-40°C to +125°C	8-Lead SOIC_N, 7" Tape and Reel	R-8		1,000
AD8132ARZ ¹	-40°C to +125°C	8-Lead SOIC_N	R-8		
AD8132ARZ-RL ¹	-40°C to +125°C	8-Lead SOIC_N, 13" Tape and Reel	R-8		2,500
AD8132ARZ-R7 ¹	-40°C to +125°C	8-Lead SOIC_N, 7" Tape and Reel	R-8		1,000
AD8132ARM	-40°C to +125°C	8-Lead MSOP	RM-8	HMA	
AD8132ARM-REEL	-40°C to +125°C	8-Lead MSOP, 13" Tape and Reel	RM-8	HMA	3,000
AD8132ARM-REEL7	-40°C to +125°C	8-Lead MSOP, 7" Tape and Reel	RM-8	HMA	1,000
AD8132ARMZ ¹	-40°C to +125°C	8-Lead MSOP	RM-8	HMA#	
AD8132ARMZ-REEL ¹	-40°C to +125°C	8-Lead MSOP, 13" Tape and Reel	RM-8	HMA#	3,000
AD8132ARMZ-REEL7 ¹	-40°C to +125°C	8-Lead MSOP, 7" Tape and Reel	RM-8	HMA#	1,000

¹ Z = Pb-free part, # denotes lead-free product may be top or bottom marked.

AD8132

NOTES

NOTES

AD8132

NOTES