

Middle Power Class-D Speaker Amplifiers

Class-D Speaker Amplifier for Digital Input



BD5451EFV

No.11075EAT17

●Description

BD5451EFV is a Class D Speaker Amplifier designed for Flat-panel TVs in particular for space-saving and low-power consumption, delivers an output power of 15W+15W. This IC employs state-of-the-art Bipolar, CMOS, and DMOS (BCD) process technology that eliminates turn-on resistance in the output power stage and internal loss due to line resistances up to an ultimate level. With this technology, the IC can achieve high efficiency of 90% (15W+15W output with 8Ω load). In addition, the IC is packaged in a compact reverse heat radiation type power package to achieve low power consumption and low heat generation and eliminates necessity of external heat-sink up to a total output power of 30W. This product satisfies both needs for drastic downsizing, low-profile structures and many function, high quality playback of sound system.

●Features

- 1) This IC has one system of digital audio interface.
(I²S format, SDATA: 16 / 20 / 24bit, LRCLK: 32kHz / 44.1kHz / 48kHz, BCLK: 64fs(fixed), MCLK: 256fs(fixed))
- 2) Low supply current at RESET mode.
- 3) The decrease in sound quality because of the change of the power supply voltage is prevented with the feedback circuitry of the output. In addition, a low noise and low distortion are achieved.
Eliminate large electrolytic-capacitors for high performance of Power Supply Rejection.
- 4) S/N of the system can be optimized by adjusting the gain setting among 2 steps. (20dB / 26dB)
- 5) Available for Monaural mode.
- 6) Within the wide range of the power supply voltage, it is possible to operate in a single power supply. (10~18V)
- 7) It contributes to miniaturizing, making to the thin type, and the power saving of the system by high efficiency and low heat.
- 8) Eliminates pop noise generated when the power supply goes on/off, or when the power supply is suddenly shut off.
High quality muting performance is realized by using the soft-muting technology.
- 9) This IC is a highly reliable design to which it has various protection functions.
(High temperature protection, under voltage protection, Output short protection, Output DC voltage protection and Clock stop protection, (MCLK, BCLK, LRCLK))
- 10) Small package (HTSSOP-B28 package) contributes to reduction of PCB area.

●Applications

Flat Panel TVs (LCD, Plasma), Home Audio, Desktop PC, Amusement equipments, Electronic Music equipments, etc.

●Absolute maximum ratings (Ta=25°C)

| Parameter | Symbol | Ratings | Unit | Parameter |
|------------------------------|-------------------|------------|------|--------------------------------|
| Supply voltage | V _{CC} | 22 | V | Pin 14, 15, 16, 27, 28 ※1 ※2 |
| Power dissipation | P _d | 3.3 | W | ※3 |
| | | 4.7 | W | ※4 |
| Input voltage | V _{IN} | -0.3 ~ 4.5 | V | Pin 1 ~ 6, 13 ※1 |
| Terminal voltage 1 | V _{PIN1} | -0.3 ~ 7.0 | V | Pin 8, 11, 12 ※1 |
| Terminal voltage 2 | V _{PIN2} | -0.3 ~ 4.5 | V | Pin 9 ※1 |
| Terminal voltage 3 | V _{PIN3} | 22 | V | Pin 17, 18, 20 ~ 23, 25, 26 ※1 |
| Open-drain terminal voltage | V _{ERR} | -0.3 ~ 22 | V | Pin 10 ※1 |
| Operating temperature range | T _{opr} | -25 ~ +85 | °C | |
| Storage temperature range | T _{stg} | -55 ~ +150 | °C | |
| Maximum junction temperature | T _{jmax} | +150 | °C | |

※1 The voltage that can be applied reference to GND (Pin 7, 19, 24).

※2 Do not, however exceed Pd and T_{jmax}=150°C.

※3 70mm×70mm×1.6mm, FR4, 2-layer glass epoxy board (Copper on bottom layer : 70mm×70mm)
Derating in done at 26.4mW/°C for operating above Ta=25°C. There are thermal via on the board.

※4 70mm×70mm×1.6mm, FR4, 4-layer glass epoxy board (Copper on bottom layer : 70mm×70mm)
Derating in done at 37.6mW/°C for operating above Ta=25°C. There are thermal via on the board.

●Operating conditions (Ta=25°C)

| Parameter | Symbol | Ratings | Unit | Parameter |
|------------------------|-----------------|---------|------|------------------------------|
| Supply voltage | V _{CC} | 10 ~ 18 | V | Pin 14, 15, 16, 27, 28 ※1 ※2 |
| Minimum load impedance | R _L | 3.6 | Ω | V _{CC} ≤ 18V ※5 |
| | | 3.2 | | V _{CC} ≤ 16V ※5 |

※5 Do not, however exceed Pd.

※ No radiation-proof design.

●Electrical characteristics

(Unless otherwise specified Ta=25°C, Vcc=12V, f=1kHz, RL=8Ω, RSTX=3.3V, MUTEX=3.3V, Gain=20dB, fs=48kHz
Output LC filter: L=10μH, C=0.1μF)

| Parameter | Symbol | Limits | | | Unit | Conditions |
|--|--------------------|--------|-------|------|-------------------|--|
| | | Min. | Typ. | Max. | | |
| Total circuit | | | | | | |
| Circuit current (Reset mode) | I _{CC1} | - | 0.1 | 0.2 | mA | Pin 14, 15, 16, 27, 28, No load RSTX=0V, MUTEX=0V |
| Circuit current (Mute mode) | I _{CC2} | - | 15 | 25 | mA | Pin 14, 15, 16, 27, 28, No load RSTX=3.3V, MUTEX=0V |
| Circuit current (Sampling mode) | I _{CC3} | - | 50 | 80 | mA | Pin 14, 15, 16, 27, 28, No load RSTX=3.3V, MUTEX=3.3V |
| Open-drain terminal Low level voltage | V _{ERR} | - | - | 0.8 | V | Pin 10, I _O =0.5mA |
| Regulator output voltage 1 | V _{REG_G} | 4.7 | 5.0 | 5.3 | V | Pin 11 |
| Regulator output voltage 2 | V _{REG_3} | 3.0 | 3.3 | 3.6 | V | Pin 9 |
| High level input voltage | V _{IH} | 2.0 | - | 3.3 | V | Pin 1 ~ 6, 13 |
| Low level input voltage | V _{IL} | 0 | - | 0.9 | V | Pin 1 ~ 6, 13 |
| Input current (Input pull-down terminal) | I _{IH} | 50 | 66 | 95 | μA | Pin 1 ~ 6, 13, V _{IN} = 3.3V |
| Speaker Output | | | | | | |
| Maximum output power 1 | P _{O1} | - | 10 | - | W | THD+n=10% GAIN=20dB ※6 |
| Maximum output power 2 | P _{O2} | - | 15 | - | W | VCC=15V, THD+n=10% GAIN =26dB ※6 |
| Voltage gain | G _{V20} | 19 | 20 | 21 | dB | P _O =1W, Gain=20dB ※6 |
| | G _{V26} | 25 | 26 | 27 | dB | P _O =1W, Gain=26dB ※6 |
| Total harmonic distortion | THD | - | 0.07 | - | % | P _O =1W, BW=20~20kHz ※6 |
| Crosstalk | CT | 66 | 80 | - | dB | P _O =1W, BW=IHF-A ※6 |
| PSRR | PSRR | - | 70 | - | dB | V _{ripple} =1V _{rms} , f= 1kHz ※6 |
| Output noise voltage (Sampling mode) | V _{NO} | - | 100 | 200 | μV _{rms} | -∞dBFS, BW=IHF-A ※6 |
| PWM sampling frequency | f _{PWM1} | - | 256 | - | kHz | fs=32kHz ※6 |
| | f _{PWM2} | - | 352.8 | - | kHz | fs=44.1kHz ※6 |
| | f _{PWM3} | - | 384 | - | kHz | fs=48kHz ※6 |

※6 These items show the typical performance of device and depend on board layout, parts, and power supply.
The standard value is in mounting device and parts on surface of ROHM's board directly.

●Electrical characteristic curves (VCC=12V, Ta=25°C, RL=8Ω, Gain=26dB, fin=1kHz, fs=48kHz)
 Measured by ROHM designed 4 layer board.

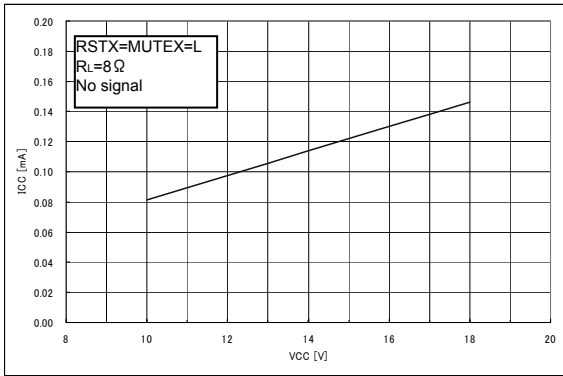

Fig.1
 Current consumption - Power supply voltage

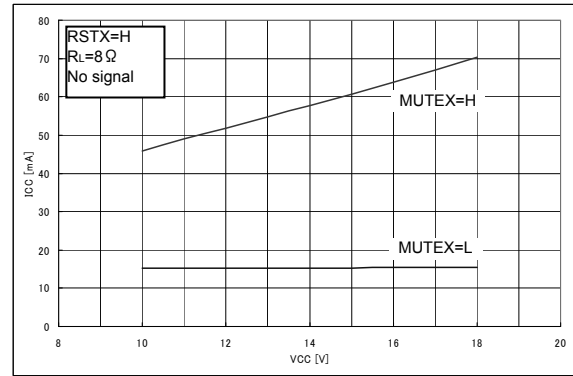

Fig.2
 Current consumption - Power supply voltage

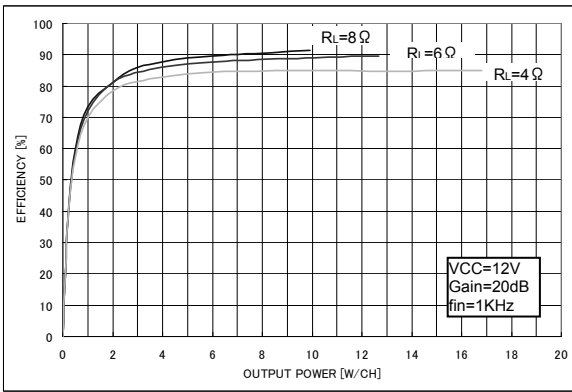

Fig.3
 Efficiency - Output power

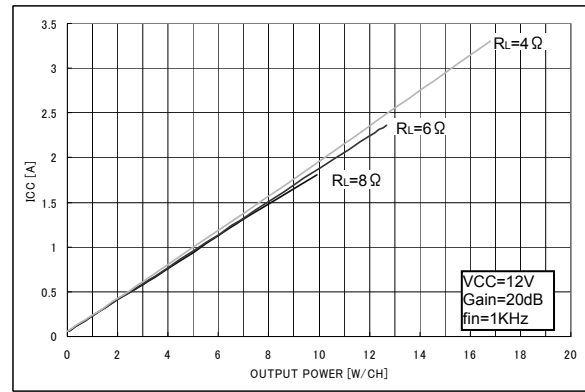

Fig.4
 Current consumption - Output power

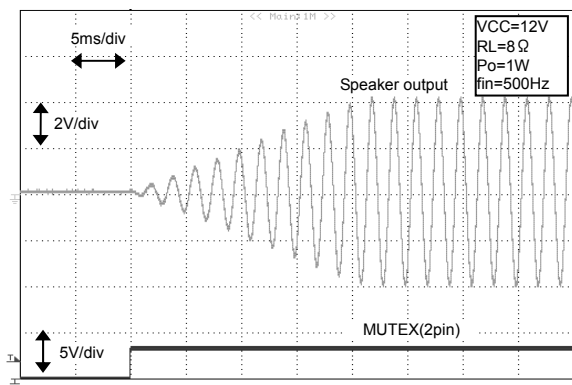

Fig.5
 Wave form when releasing soft-mute

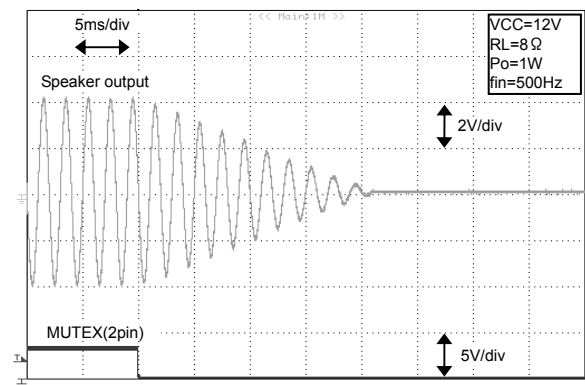

Fig.6
 Wave form when activating soft-mute

●Electrical characteristics (VCC=12V, Gain=26dB, fin=1kHz, fs=48kHz)
 Measured by ROHM designed 4 layer board.

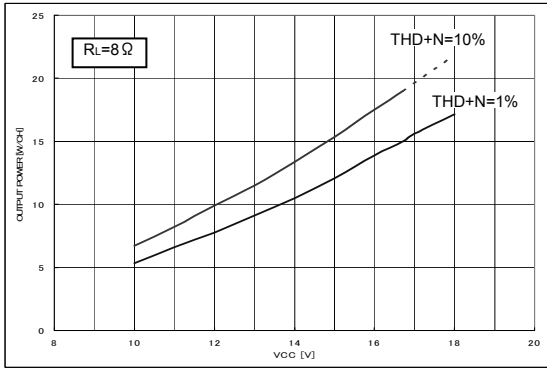

Fig.7
 Output power – Power supply voltage

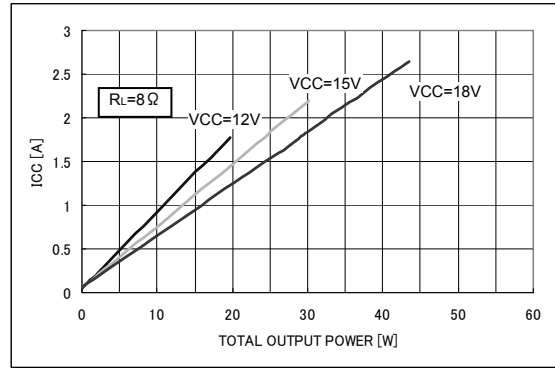

Fig.8
 Current consumption - Output power

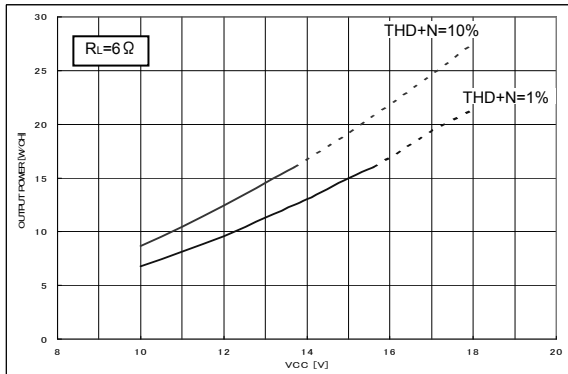

Fig.9
 Output power – Power supply voltage

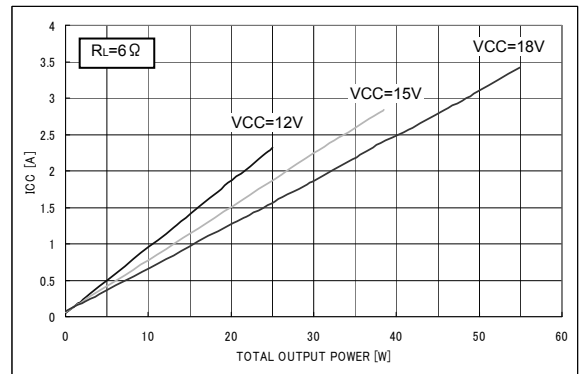

Fig.10
 Current consumption - Output power

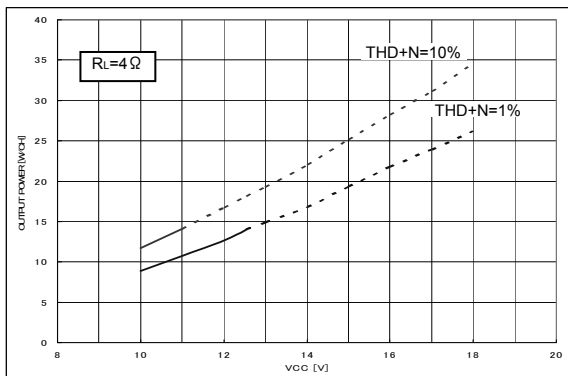

Fig.11
 Output power – Power supply voltage

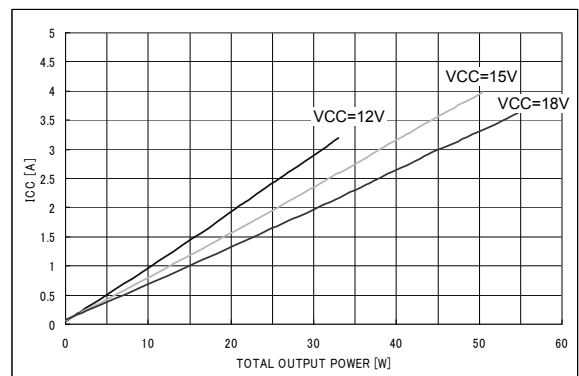

Fig.12
 Current consumption - Output power

※Dotted line means internal dissipation is over package power.

●Electrical characteristic curves(VCC=12V, Ta=25°C, RL=8Ω, Gain=20dB, fin=1kHz, fs=48kHz)

Measured by ROHM designed 4layer board.

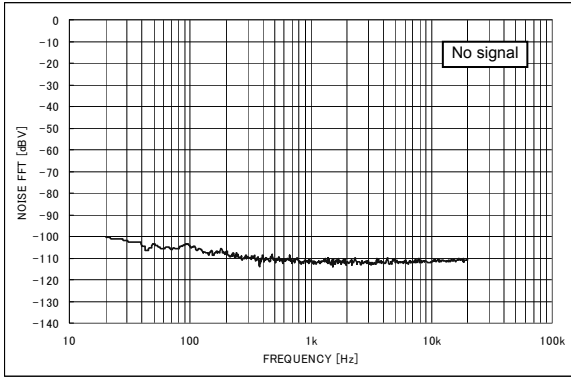

Fig.13
FFT of output noise voltage

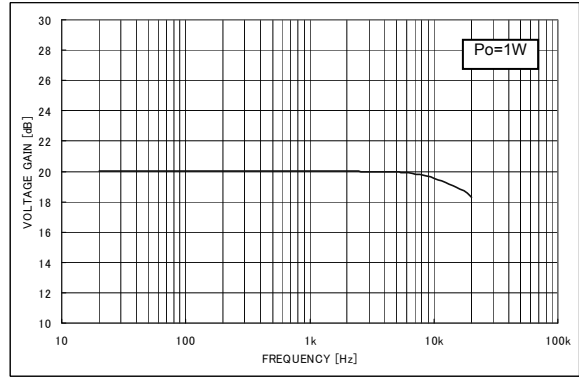

Fig.14
Voltage gain - Frequency

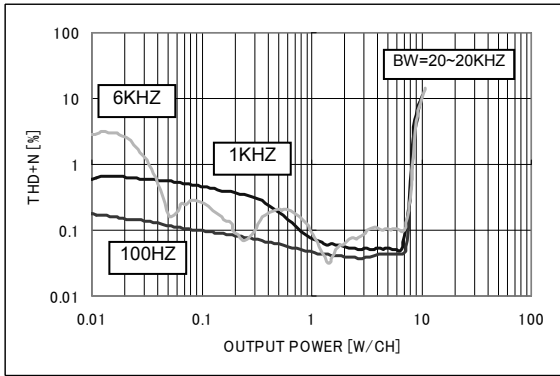

Fig.15
THD+N - Output power

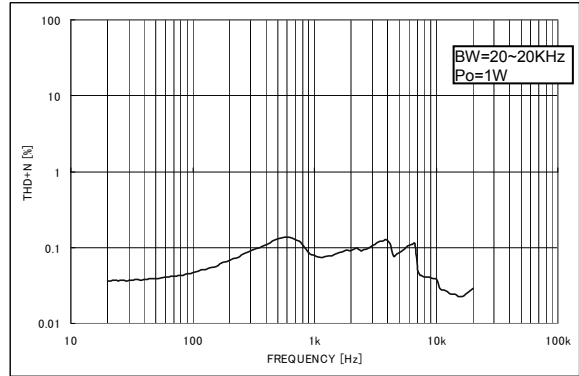

Fig.16
THD+N - Frequency

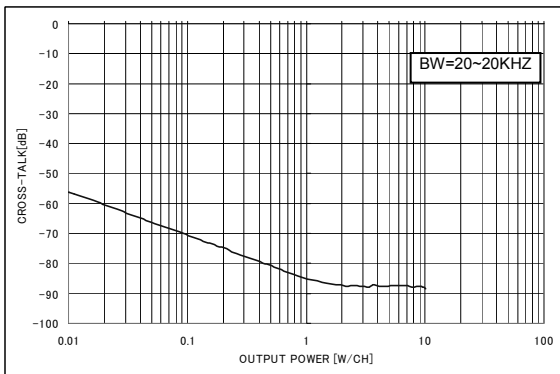

Fig.17
Crosstalk - Output power

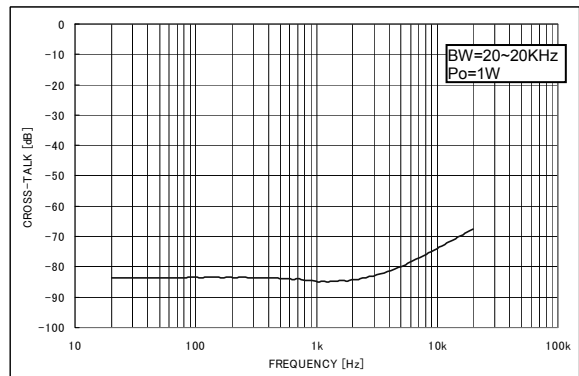

Fig.18
Crosstalk - Frequency

●Electrical characteristic curves(VCC=12V, Ta=25°C, RL=6Ω, Gain=20dB, fin=1kHz, fs=48kHz)

Measured by ROHM designed 4layer board

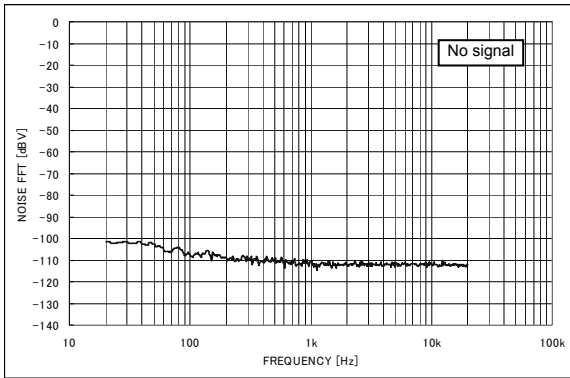

Fig.19
FFT of output noise voltage

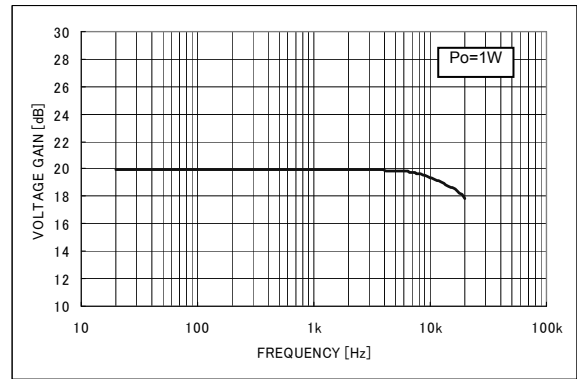

Fig.20
Voltage gain - Frequency

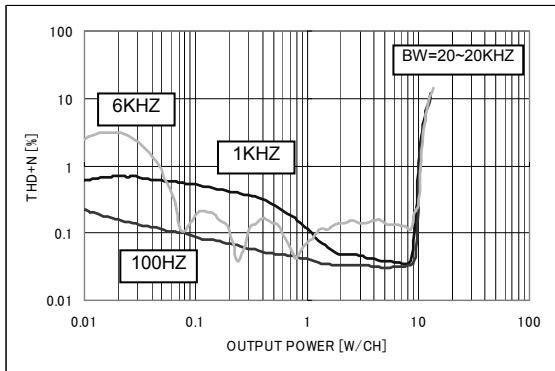

Fig.21
THD+N – Output power

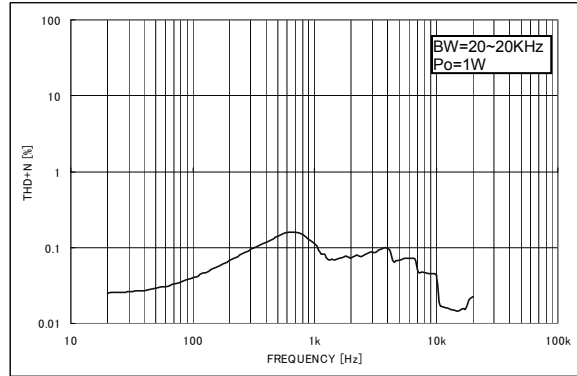

Fig.22
THD+N – Frequency

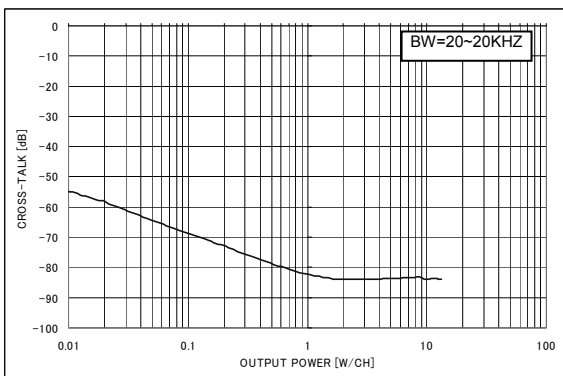

Fig.23
Crosstalk – Output power

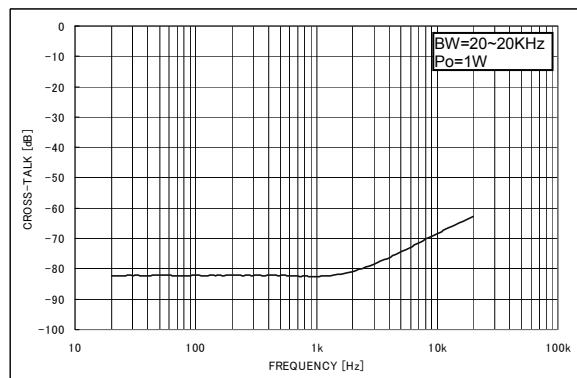

Fig.24
Crosstalk – Frequency

●Electrical characteristic curves(VCC=12V, Ta=25°C, RL=4Ω, Gain=20dB, fin=1kHz, fs=48kHz)

Measured by ROHM designed 4layer board

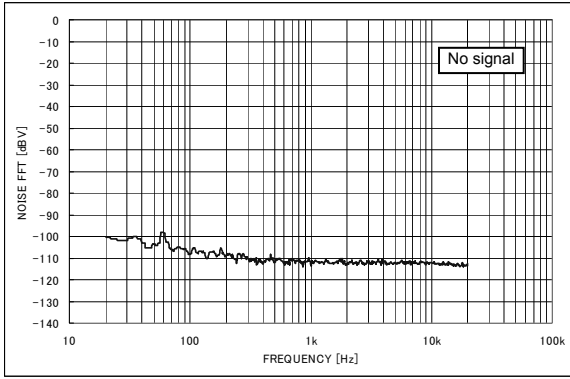

Fig.25
FFT of output noise voltage

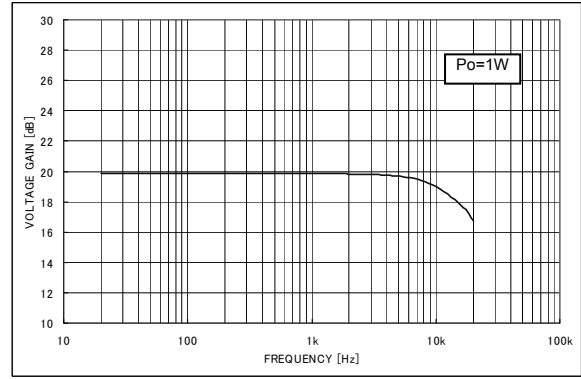

Fig.26
Voltage gain - Frequency

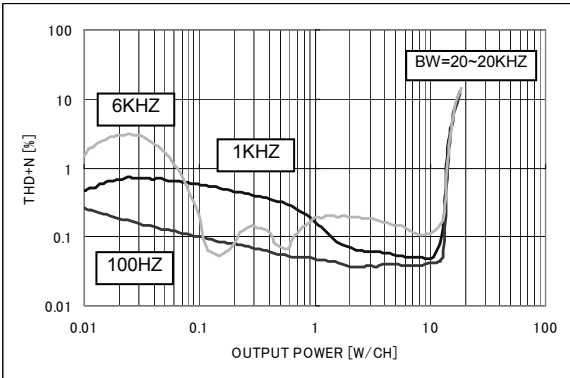

Fig.27
THD+N – Output power

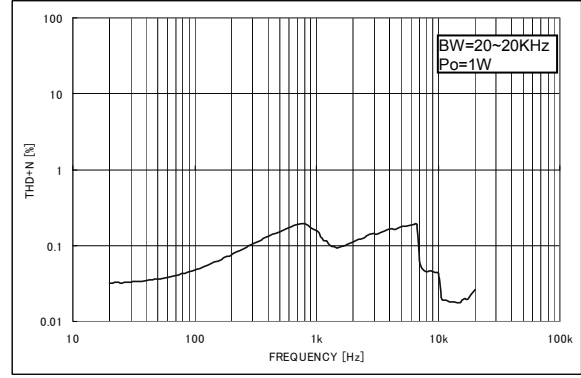

Fig.28
THD+N – Frequency

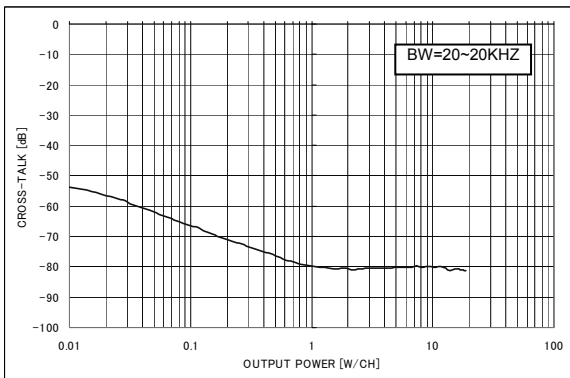

Fig.29
Crosstalk – Output power

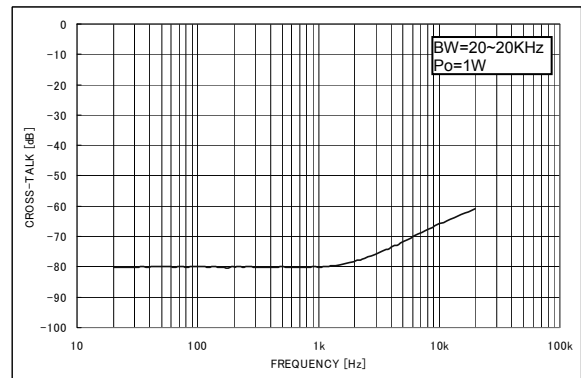
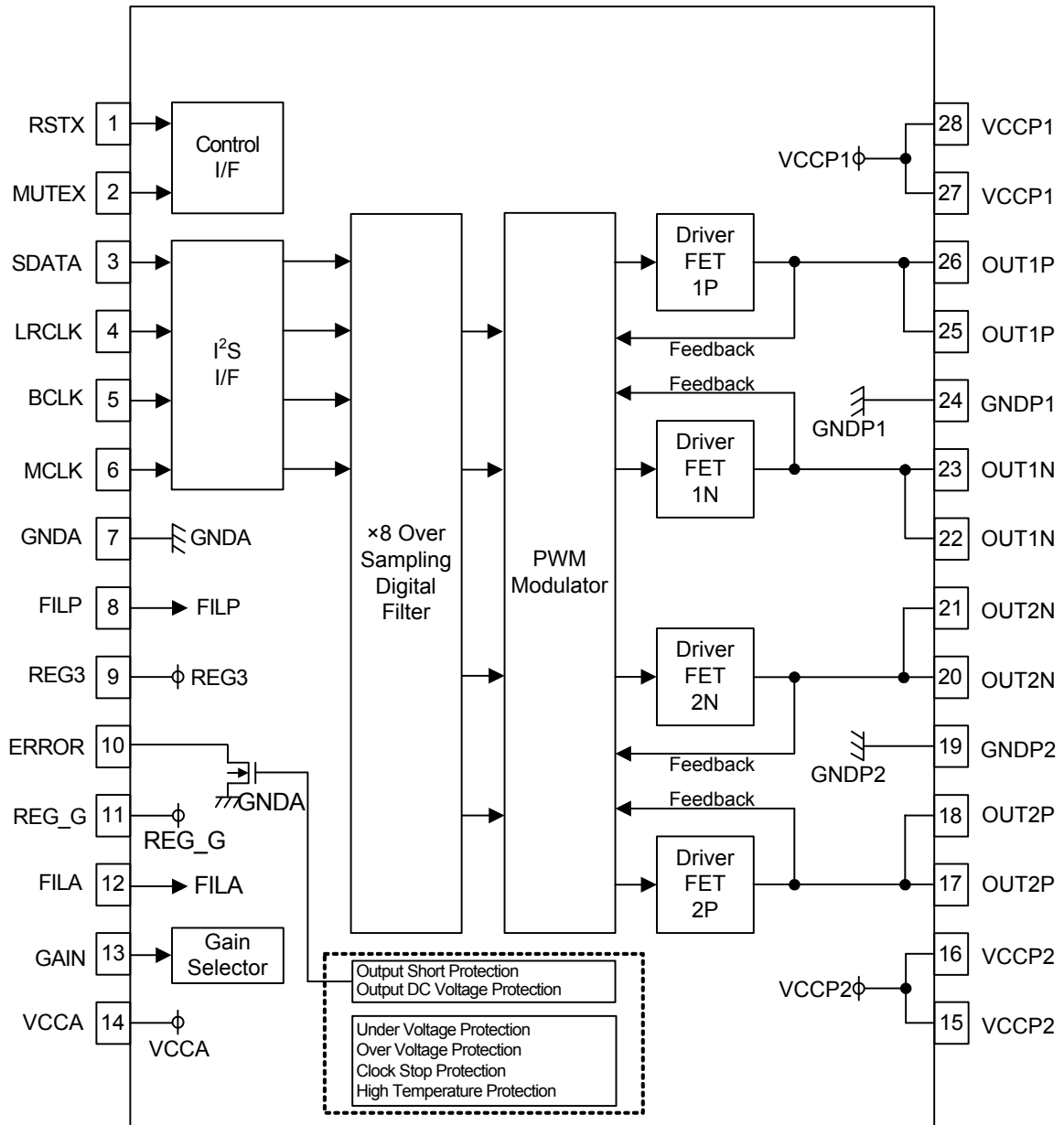

Fig.30
Crosstalk – Frequency

● Pin configuration and Block diagram



●Pin function explanation (Provided pin voltages are typ. Values)

| Pin No. | Pin name | Pin voltage | Pin explanation | Internal equivalence circuit |
|---------|----------|-------------|---|------------------------------|
| 1 | RSTX | 0V | Reset pin for Digital circuit H: Reset OFF L: Reset ON | |
| 2 | MUTEX | 0V | Speaker output mute control pin H: Mute OFF L: Mute ON | |
| 3 | SDATA | | Digital audio signal input pin | |
| 4 | LRCLK | | | |
| 5 | BCLK | | | |
| 6 | MCLK | | | |
| 12 | GAIN | | Gain setting terminal L: 20dB H: 26dB | |
| 7 | GNDA | 0V | GND pin for Analog signal | - |
| 8 | FILP | 1.75V~2.55V | Bias pin for PWM signal Please connect the capacitor. | |
| 9 | REG3 | 3.3V | Internal power supply pin for Digital circuit Please connect the capacitor. | |
| 10 | ERROR | 3.3V | Error flag pin Please connect pull-up resistor. H: While Normal L: While Error | |
| 11 | REG_G | 5.2V | Internal power supply pin for Gate driver Please connect the capacitor. | |

| Pin No. | Pin name | Pin voltage | Pin explanation | Internal equivalence circuit |
|---------|----------|-------------|--|------------------------------|
| 12 | FILA | 2.5V | Bias pin for PWM signal. Please connect the capacitor. | |
| 14 | VCCA | Vcc | Power supply pin for Analog signal | — |
| 15,16 | VCCP2 | Vcc | Power supply pin for ch2 PWM signal Please connect the capacitor. | |
| 17,18 | OUT2P | Vcc~0V | Output pin of ch2 positive PWM Please connect to Output LPF. | |
| 19 | GNDP2 | 0V | GND pin for ch2 PWM signal | |
| 20,21 | OUT2N | Vcc~0V | Output pin of ch2 negative PWM Please connect to Output LPF. | |
| 22,23 | OUT1N | Vcc~0V | Output pin of ch1 negative PWM Please connect to Output LPF. | |
| 24 | GNDP1 | 0V | GND pin for ch1 PWM signal | |
| 25,26 | OUT1P | Vcc~0V | Output pin of ch1 positive PWM Please connect to Output LPF. | |
| 27,28 | VCCP1 | — | Power supply pin for ch1 PWM signal Please connect the capacitor. | |

● Terminal setting

(1) Gain pin function

| GAIN (13pin) | Speaker output gain |
|-----------------|---------------------|
| L | 20dB |
| H | 26dB |

(2) RSTX pin, MUTEX pin function

| RSTX (1pin) | MUTEX (2pin) | Normalcy | | Error detecting | |
|----------------|-----------------|--|-----------------|-----------------------------------|-----------------|
| | | PWM output (OUT1P, 1N, 2P, 2N) | ERROR Output | PWM output (OUT1P, 1N, 2P, 2N) | ERROR Output |
| L | L or H | HiZ_L (Reset mode) | H | HiZ_L (Reset mode) | H |
| H | L | HiZ_L (MUTE _{ON}) | H | HiZ_L (MUTE _{ON}) | L |
| H | H | Normal operation (MUTE _{OFF}) | H | HiZ_L (MUTE _{ON}) | L |

※RSTX(1pin)terminal, MUTEX(2pin)terminal are internally pulled down by 50 kΩ (Typ.)

※With RSTX=L data of every register within IC (I²S / I/F part, × 8 over sampling digital filter part, latch circuit when detecting ERROR) becomes unnecessary.

● Input digital audio signal sampling frequency (fs) explanation

PWM sampling frequency, Soft-start, Soft-mute time, and the detection time of the DC voltage protection in the speaker depends on sampling frequency (fs) of the digital audio input.

| Sampling frequency of the digital audio input (fs) | PWM sampling frequency (fpwm) | Soft-start / Soft-mute time | DC voltage protection in the speaker detection time |
|--|----------------------------------|-----------------------------|--|
| 32kHz | 256kHz | 32msec. | 64msec. |
| 44.1kHz | 352.8kHz | 23msec. | 46msec. |
| 48kHz | 384kHz | 21.5msec. | 43msec. |

● For voltage gain (Gain setting)

BD5451EFV prescribe voltage gain at speaker output (BTL output) under the definition 0dBV (1Vrms) as full scale input of the digital audio input signal. For example, digital audio input signal = -20dBFS (0.1Vrms), Gain setting = 20dB, Load resistance $R_L = 8\ \Omega$ will give speaker output (BTL output) amplitude as $V_o=1Vrms$. (Output power $P_o = V_o^2/R = 0.125W$)

●Format of digital audio input

- MCLK: It is System Clock input signal.
It will input LRCLK, BCLK, SDATA that synchronizes with this clock that are 256 times of sampling frequency (256fs).
- LRCLK: It is L/R clock input signal.
It corresponds to 32kHz / 44.1kHz / 48kHz with those clock (fs) that are same to the sampling frequency (fs) .
The data of a left channel and a right channel for one sample is input to this section.
- BCLK: It is Bit Clock input signal.
It is used for the latch of data in every one bit by sampling frequency's 64 times sampling frequency (64fs).
- SDATA: It is Data input signal.
It is amplitude data. The data length is different according to the resolution of the input digital audio data.
It corresponds to 16/ 20/ 24 bit.

●I²S data format

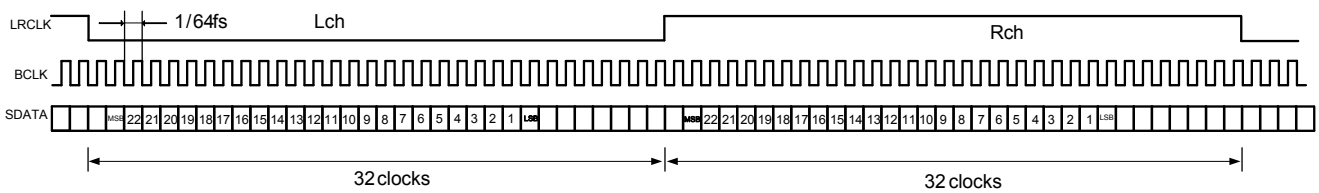

Fig.31 I²S Data Format 64fs, 24 bit Data

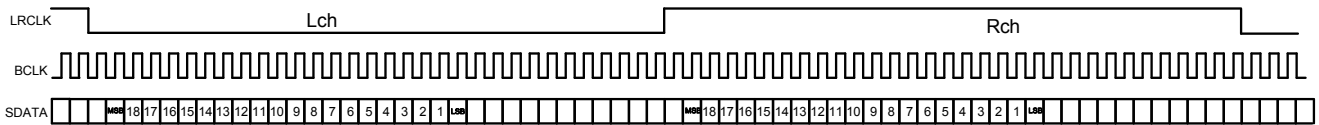

Fig.32 I²S Data Format 64fs, 20 bit Data

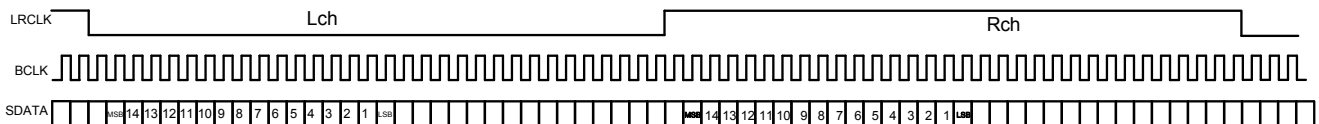

Fig.33 I²S Data Format 64fs, 16 bit Data

The Low section of LRCLK becomes Lch, the High section of LRCLK becomes Rch.
After changing LRCLK, second bit becomes MSB.

●Audio Interface format and timing

Recommended timing and operating conditions (MCLK, BCLK, LRCLK, SDATA)

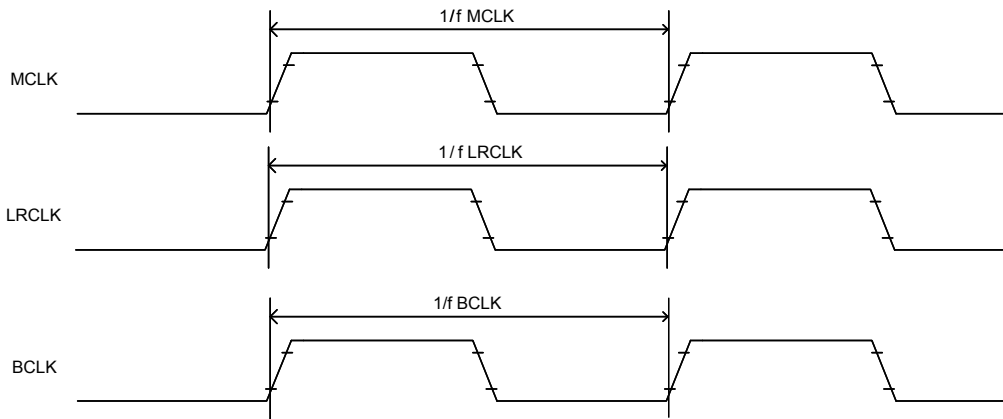

Fig.34 Clock timing

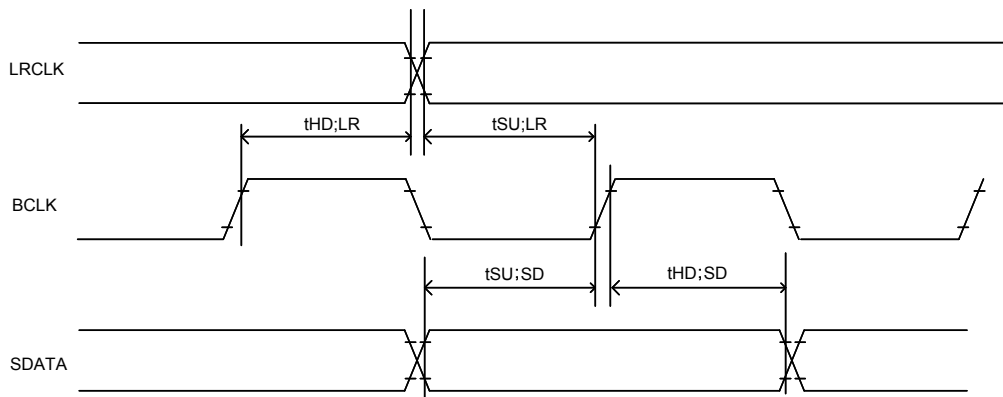

Fig.35 Audio Interface timing (1)

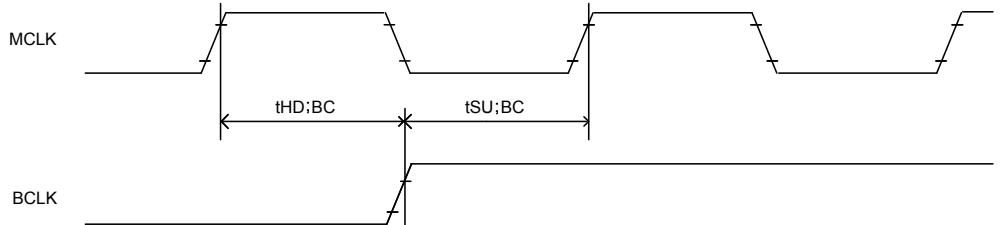

Fig.36 Audio Interface timing (2)

| Parameter | Symbol | Limit | | Unit |
|-----------------------|--------|-------|--------|------|
| | | Min. | Max. | |
| 1 MCLK frequency | fMCLK | 8.192 | 12.288 | MHz |
| 2 LRCLK frequency | fLRCLK | 32 | 48 | kHz |
| 3 BCLK frequency | fBCLK | 2.048 | 3.072 | MHz |
| 4 Setup time, LRCLK※1 | tSU;LR | 20 | — | ns |
| 5 Hold time, LRCLK※1 | tHD;LR | 20 | — | ns |
| 6 Setup time, SDATA | tSU;SD | 20 | — | ns |
| 7 Hold time, SDATA | tHD;SD | 20 | — | ns |
| 8 Setup time, BCLK※2 | tSU;BC | 3 | — | ns |
| 9 Hold time, BCLK※2 | tHD;BC | 7 | — | ns |

※1 This regulation is to keep rising edge of LRCK and rising edge of BCLK from overlapping.

※2 This regulation is to keep rising edge of MCLK and rising edge of BCLK from overlapping.

●Power supply start-up sequence

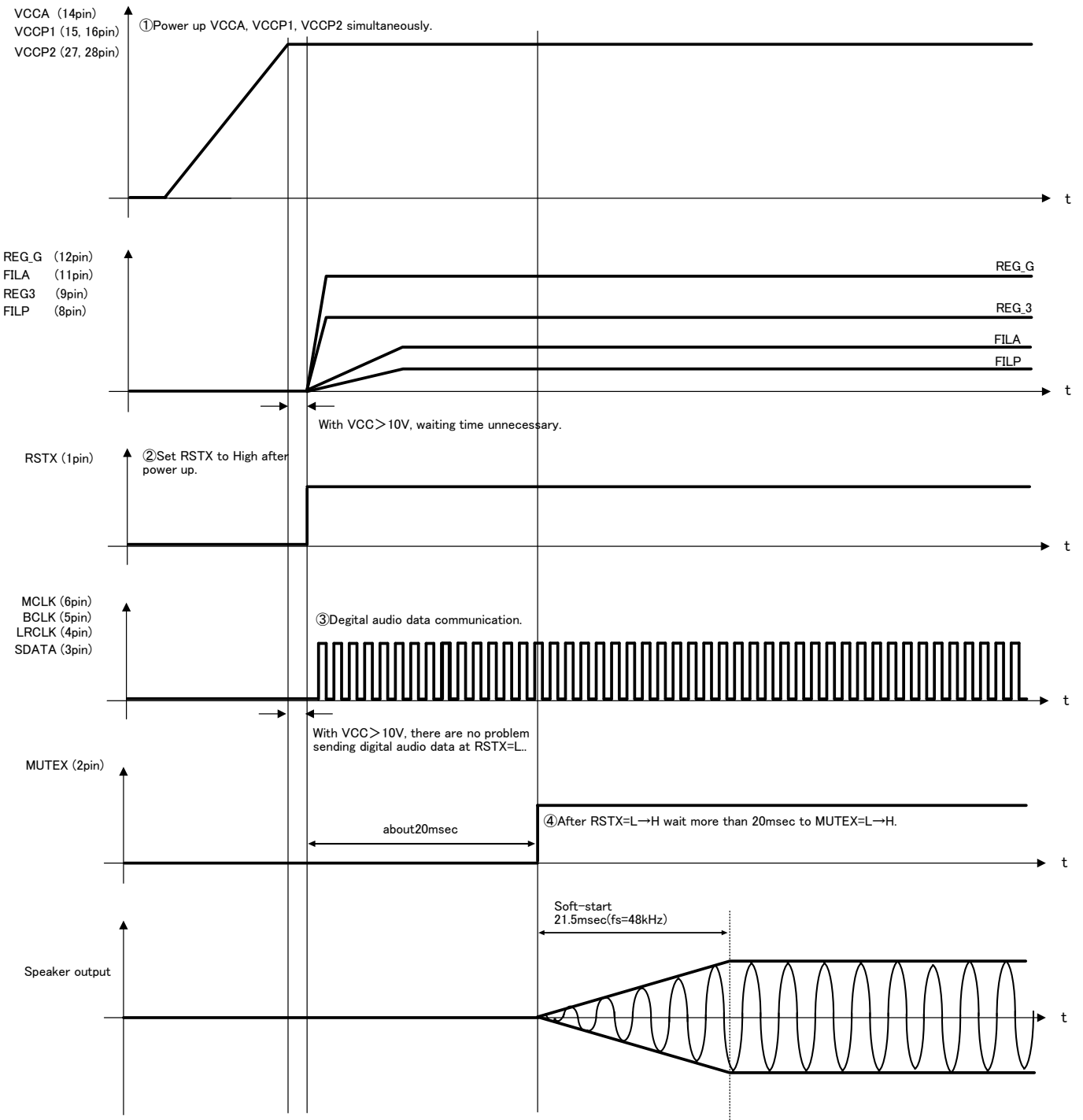

●Power supply shut-down sequence

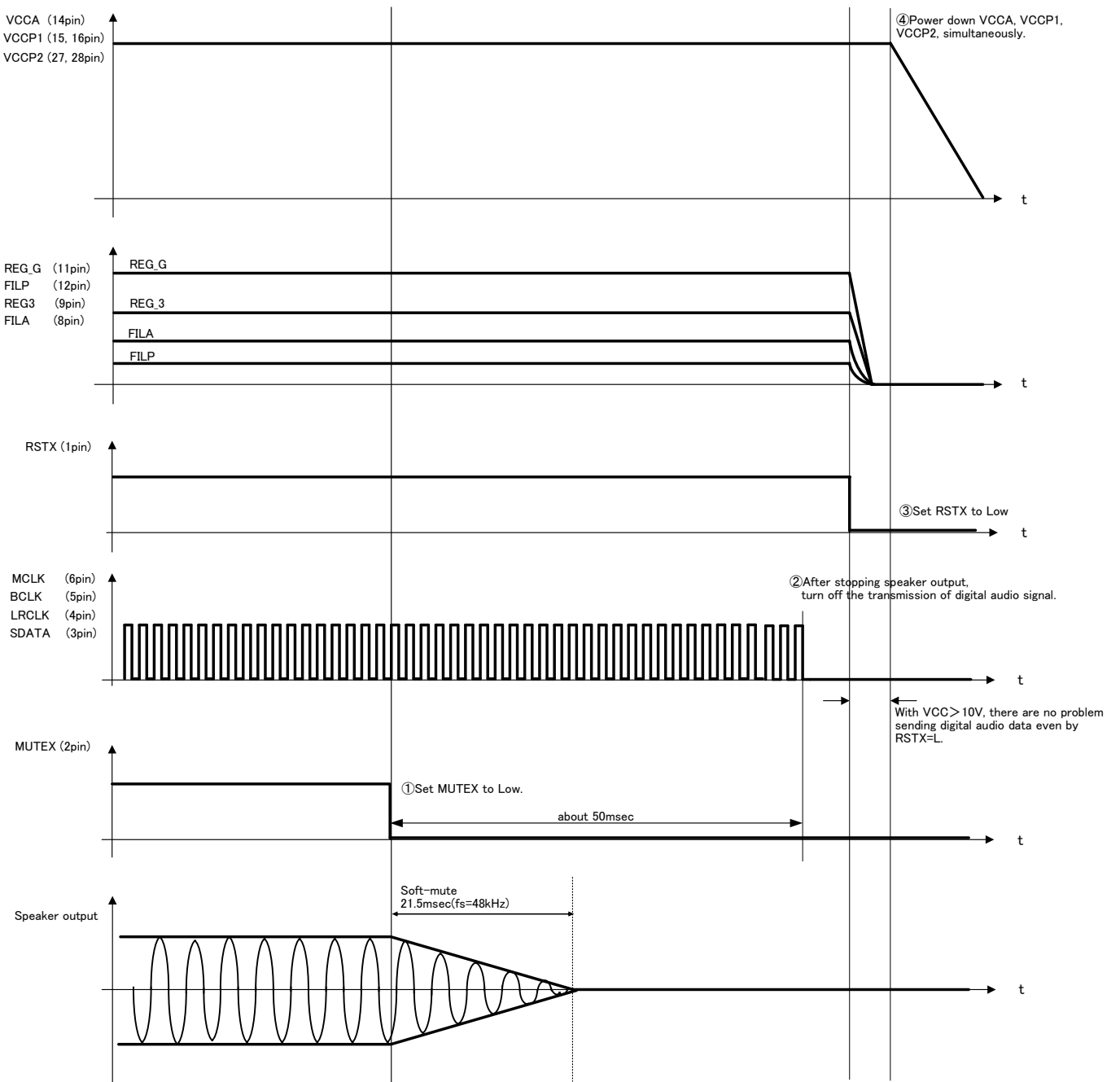

●About the protection function

| Protection function | Detecting & Releasing condition | | PWM Output | ERROR Output |
|--------------------------------------|---------------------------------|---|------------------|--------------|
| Output short protection | Detecting condition | Detecting current = 10A (TYP.) | HiZ_Low (Latch) | L (Latch) |
| DC voltage protection in the speaker | Detecting condition | PWM output Duty=0% or 100% 43msec(fs=48kHz) above fixed | HiZ_Low (Latch) | L (Latch) |
| High temperature protection | Detecting condition | Chip temperature to be above 150°C (TYP.) | HiZ_Low | H |
| | Releasing condition | Chip temperature to be below 120°C (TYP.) | Normal operation | |
| Under voltage protection | Detecting condition | Power supply voltage to be below 8V (TYP.) | HiZ_Low | H |
| | Releasing condition | Power supply voltage to be above 9V (TYP.) | Normal operation | |
| Over voltage Protection | Detecting condition | Power supply voltage to be above 21.5V(TYP.) | HiZ_Low | H |
| | Releasing condition | Power supply voltage to be below 20.5V(TYP.) | Normal operation | |
| Clock stop protection | Detecting condition | No change to MCLK more than 1μsec (TYP.) or no change to BCLK more than 1μsec (TYP.) or no change to LRCLK more than 21μsec (at fs=48kHz.). | HiZ_Low | H |
| | Releasing condition | Normal input to MCLK, BCLK and LRCLK. | Normal operation | |

* The ERROR pin is Nch open-drain output.

* Once an IC is latched, the circuit is not released automatically even after an abnormal status is removed.

The following procedures ① or ② is available for recovery.

①After turning MUTEX terminal to Low(holding time to Low = 10msec(Min.)) turn back to High again.

②Restore power supply after dropping to power supply voltage $V_{cc} < 3V$ (10msec (Min.) holding) which internal power on reset circuit activates.

1) Output short protection(Short to the power supply)

This IC has the PWM output short protection circuit that stops the PWM output when the PWM output is short-circuited to the power supply due to abnormality.

Detecting condition - It will detect when MUTEX pin is set High and the current that flows in the PWM output pin becomes 10A(TYP.) or more. The PWM output instantaneously enters the state of HiZ-Low if detected, and IC does the latch.

Releasing method - ①After turning MUTEX terminal to Low(holding time to Low = 10msec(Min.)) turn back to High again.

②Restore power supply after dropping to power supply voltage $V_{cc} < 3V$ (10msec (Min.) holding) which internal power on reset circuit activates.

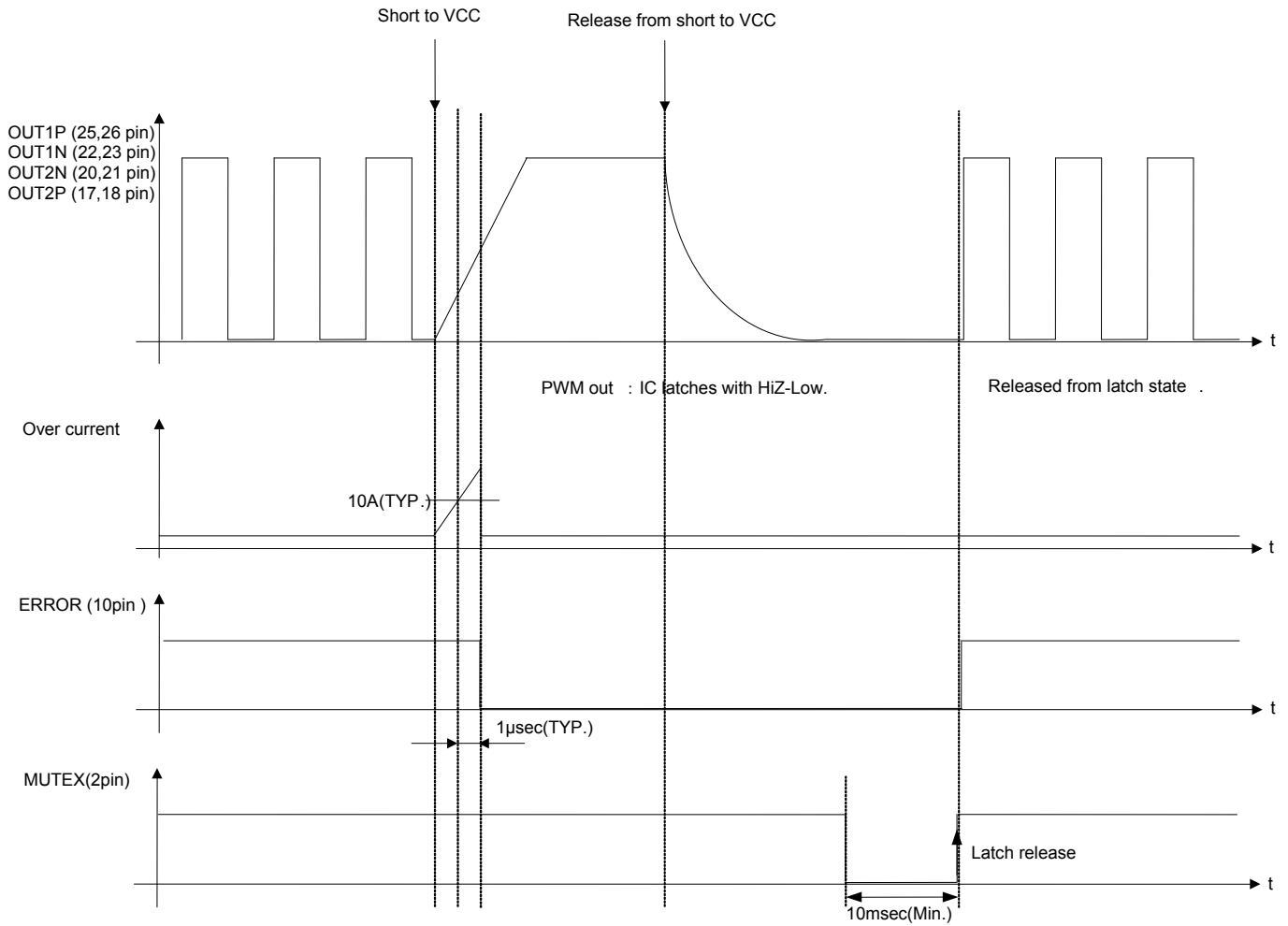

2) Output short protection(Short to GND)

This IC has the PWM output short protection circuit that stops the PWM output when the PWM output is short-circuited to GND due to abnormality.

Detecting condition - It will detect when MUTEX pin is set High and the current that flows in the PWM output terminal becomes 10A(TYP.) or more. The PWM output instantaneously enters the state of HiZ-Low if detected, and IC does the latch.

Releasing method - ①After turning MUTEX terminal to Low(holding time to Low = 10msec(Min.)) turn back to High again.

②Restore power supply after dropping to power supply voltage $V_{cc} < 3V$ (10msec (Min.) holding) which internal power on reset circuit activates.

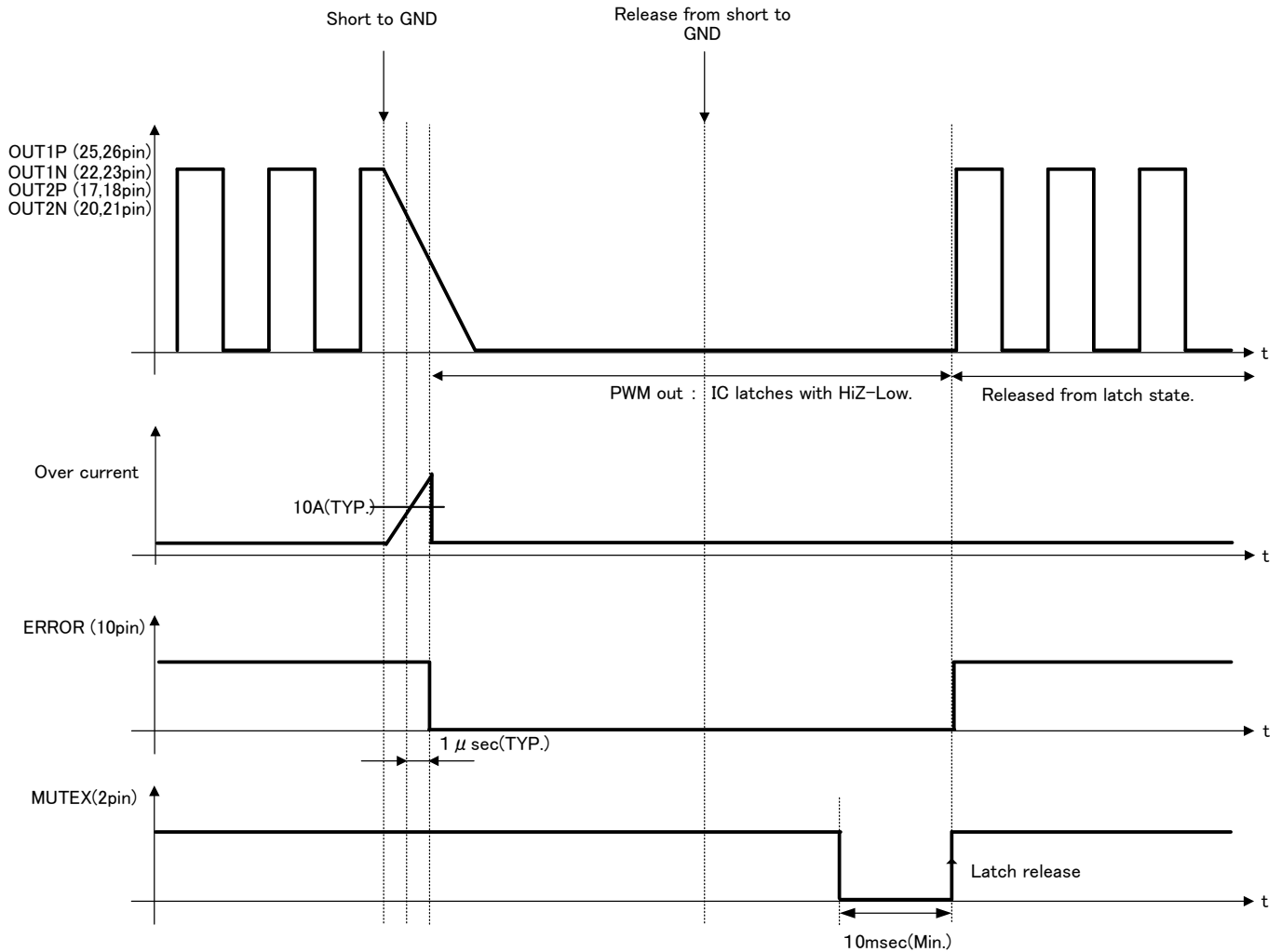

3)DC voltage protection in the speaker

When the DC voltage in the speaker is impressed due to abnormality, this IC has the protection circuit where the speaker is defended from destruction.

Detecting condition - It will detect when MUTEX pin is set High or Low and PWM output Duty=0% or 100% , 43msec(fs=48kHz) or above. Once detected, The PWM output instantaneously enters the state of HiZ-Low, and IC does the latch.

Releasing method – ①After turning MUTEX terminal to Low(holding time to Low = 10msec(Min.)) turn back to High again.

②Restore power supply after dropping to power supply voltage $V_{cc} < 3V$ (10msec (Min.) holding) which internal power on reset circuit activates.

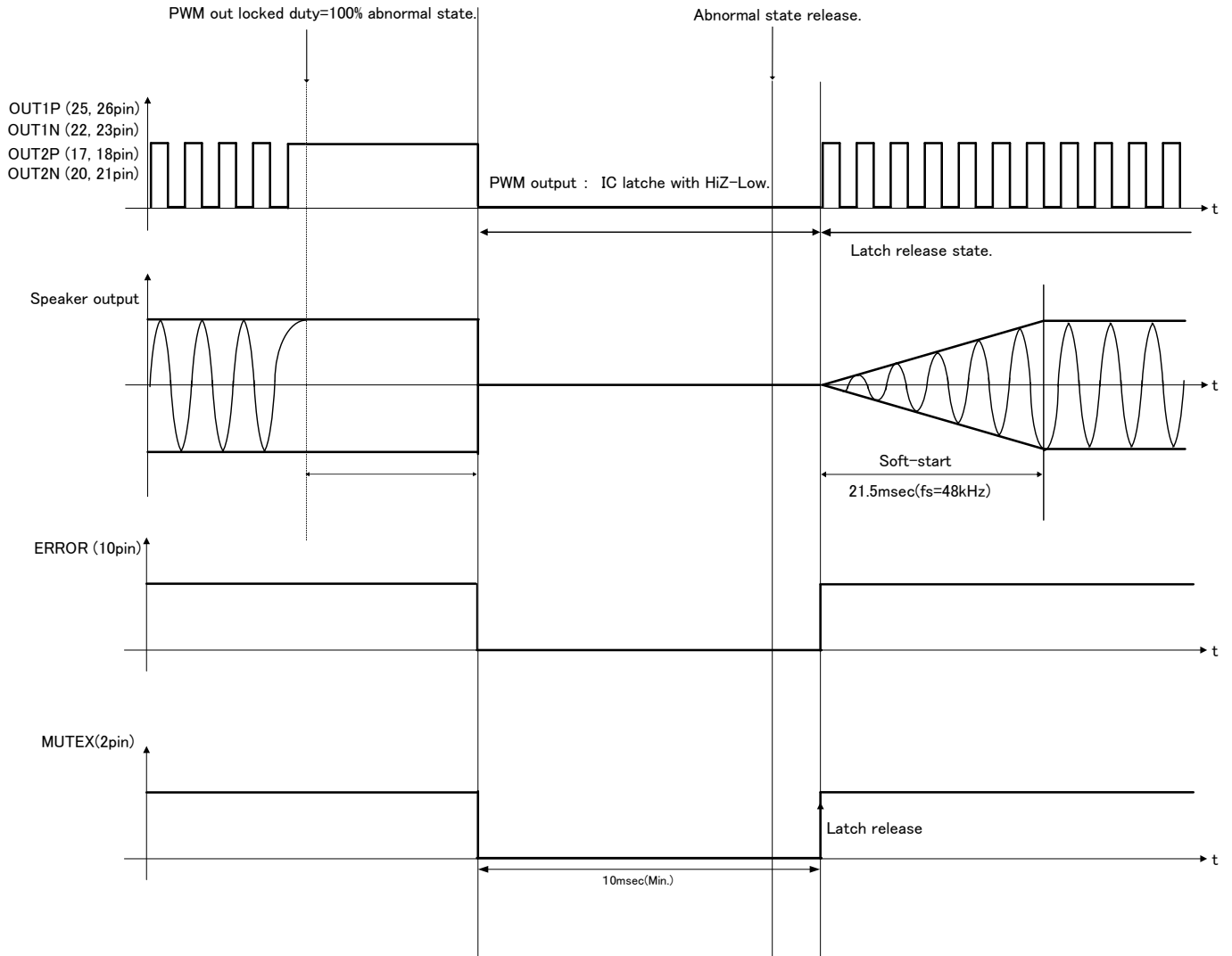

4) High temperature protection

This IC has the high temperature protection circuit that prevents thermal reckless driving under an abnormal state for the temperature of the chip to exceed $T_{jmax}=150^{\circ}\text{C}$.

Detecting condition - It will detect when MUTEX pin is set High and the temperature of the chip becomes 150°C (TYP.) or more. Speaker output turn MUTE immediately, when High temperature protection is detected.

Releasing condition - It will release when MUTEX pin is set High and the temperature of the chip becomes 120°C (TYP.) or less. The speaker output is outputted through a soft-start when released.

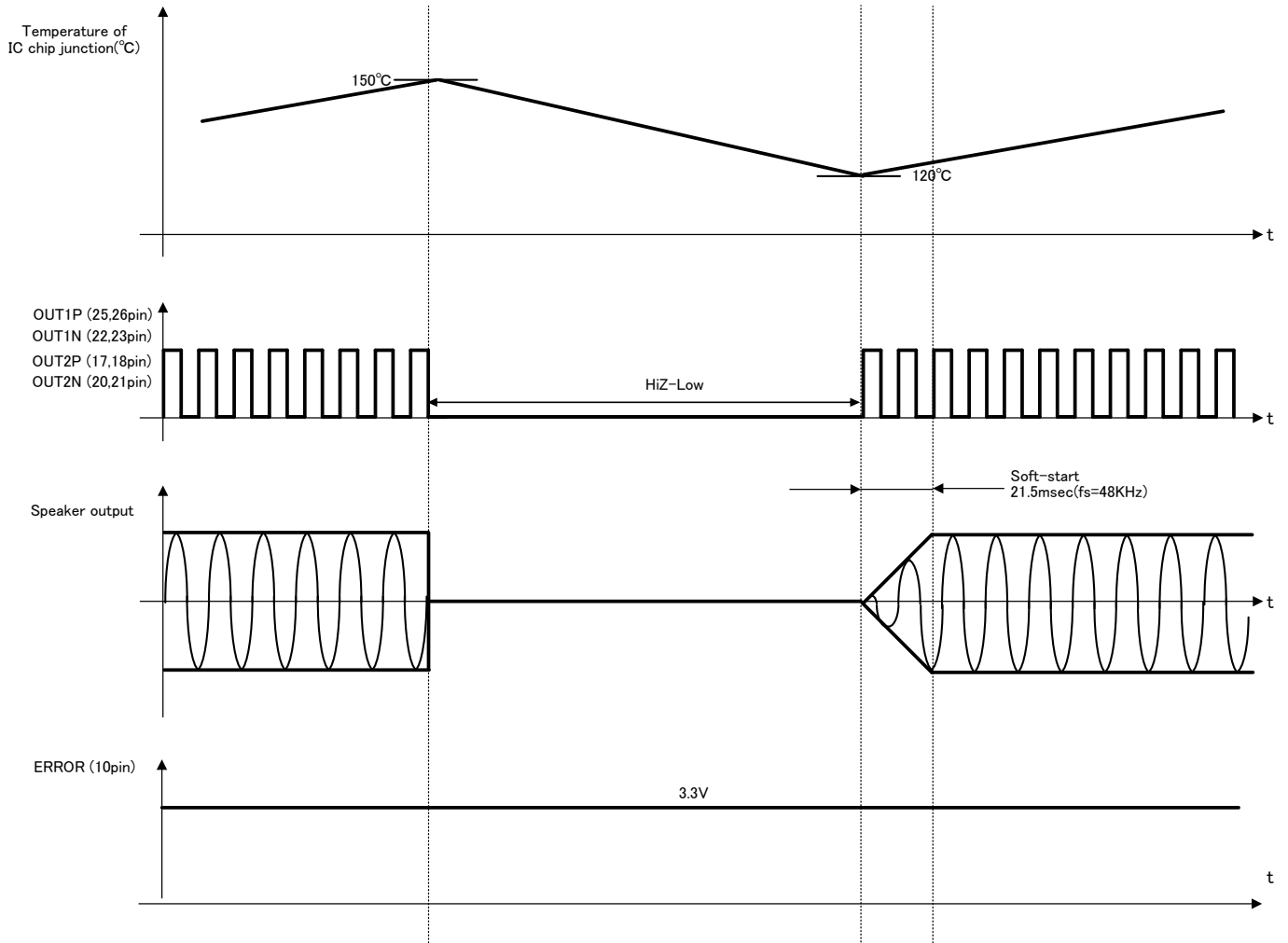

5) Under voltage protection

This IC has the under voltage protection circuit that make speaker output mute once detecting extreme drop of the power supply voltage.

Detecting condition – It will detect when MUTEX pin is set High and the power supply voltage becomes lower than 8V. Speaker output turn MUTE immediately, when Under voltage protection is detected.

Releasing condition – It will release when MUTEX pin is set High and the power supply voltage becomes more than 9V. The speaker output is outputted through a soft-start when released.

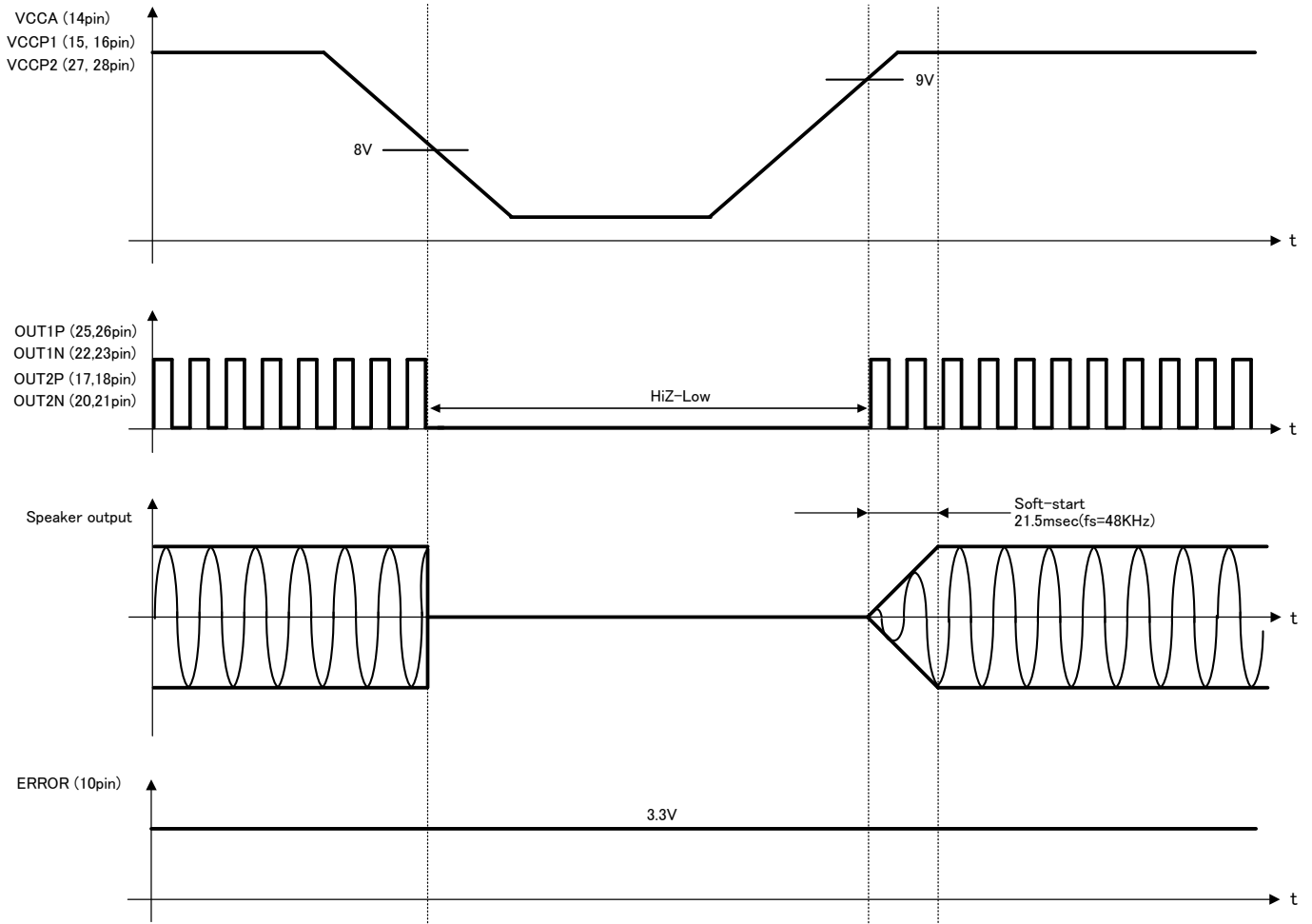

6) Over voltage protection

This IC has the under voltage protection circuit that make speaker output mute once detecting extreme drop of the power supply voltage.

Detecting condition – It will detect when MUTEX pin is set High and the power supply voltage becomes more than 21.5V. Speaker output turn MUTE immediately, when over voltage protection is detected.

Releasing condition – It will release when MUTEX pin is set High and the power supply voltage becomes lower than 20.5V. The speaker output is outputted through a soft-start when released.

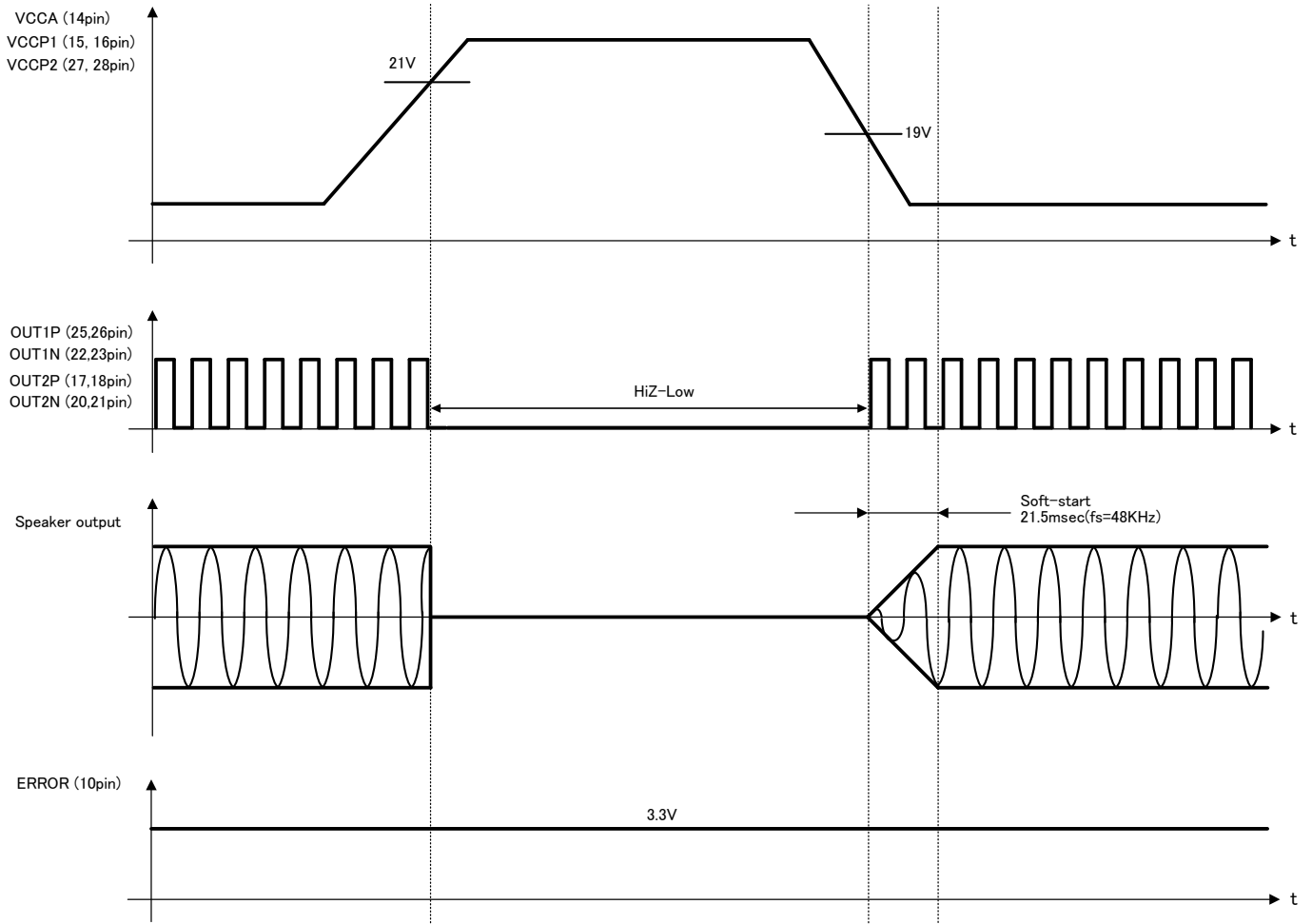

7-1) Clock stop protection(MCLK)

This IC has the clock stop protection circuit that make the speaker output mute when the MCLK signal of the digital audio input stops.

Detecting condition - It will detect when MUTEX pin is set High and the MCLK signal stops for about 1 μ sec or more. 21.5V. Speaker output turn MUTE immediately, clock stop protection is detected.

Releasing condition - It will release when MUTEX pin is set High and the MCLK signal returns to the normal clock operation. The speaker output is outputted through a soft-start when released.

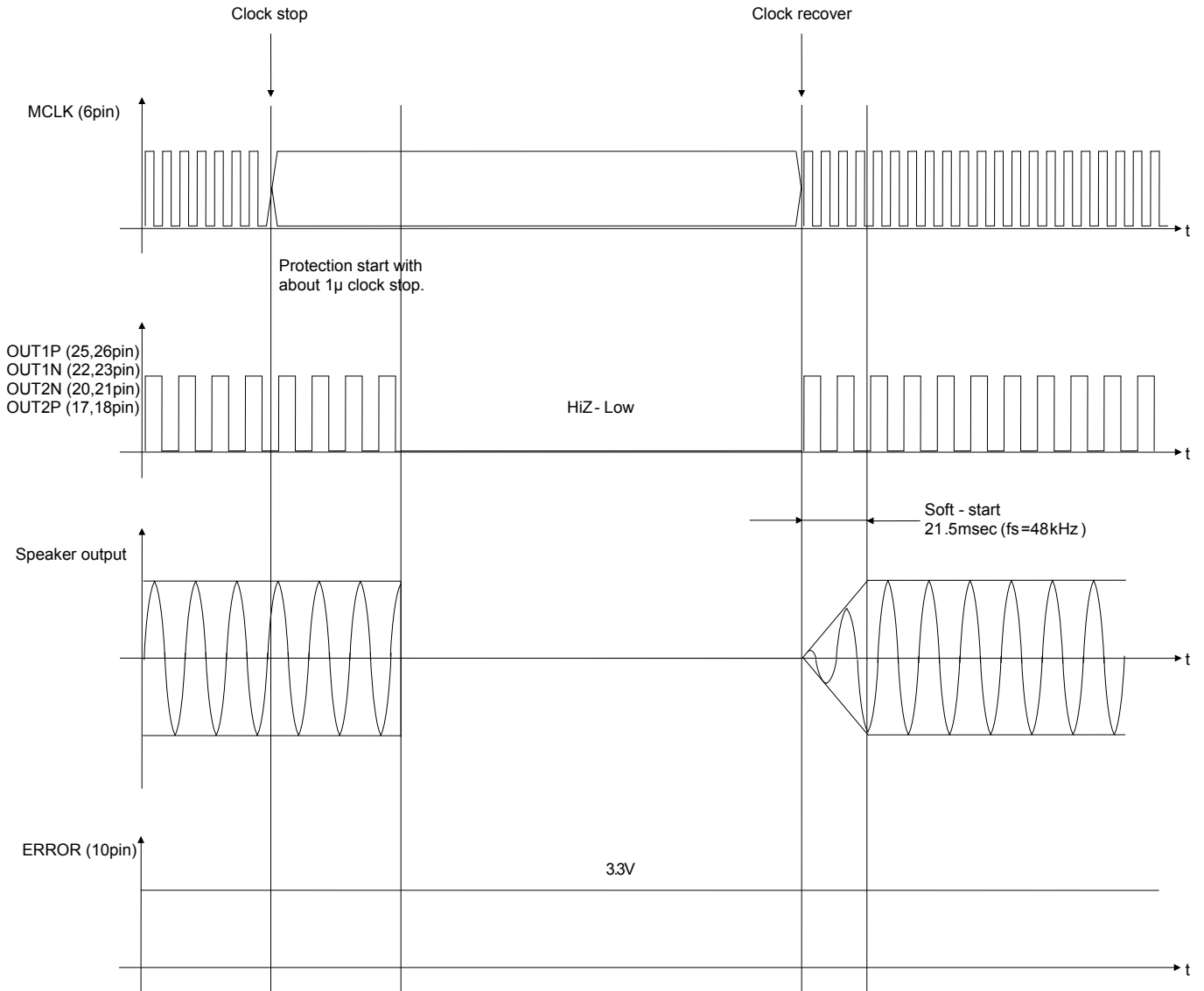

7-2) Clock stop protection(BCLK)

This IC has the clock stop protection circuit that make the speaker output mute when the BCLK signal of the digital audio input stops.

Detecting condition - It will detect when MUTEX pin is set High and the BCLK signal stops for about 1 μ sec or more. 21.5V.Speaker output turn MUTE immediately, when clock stop protection is detected.

Releasing condition - It will release when MUTEX pin is set High and the BCLK signal returns to the normal clock operation. The speaker output is outputted through a soft-start when released.

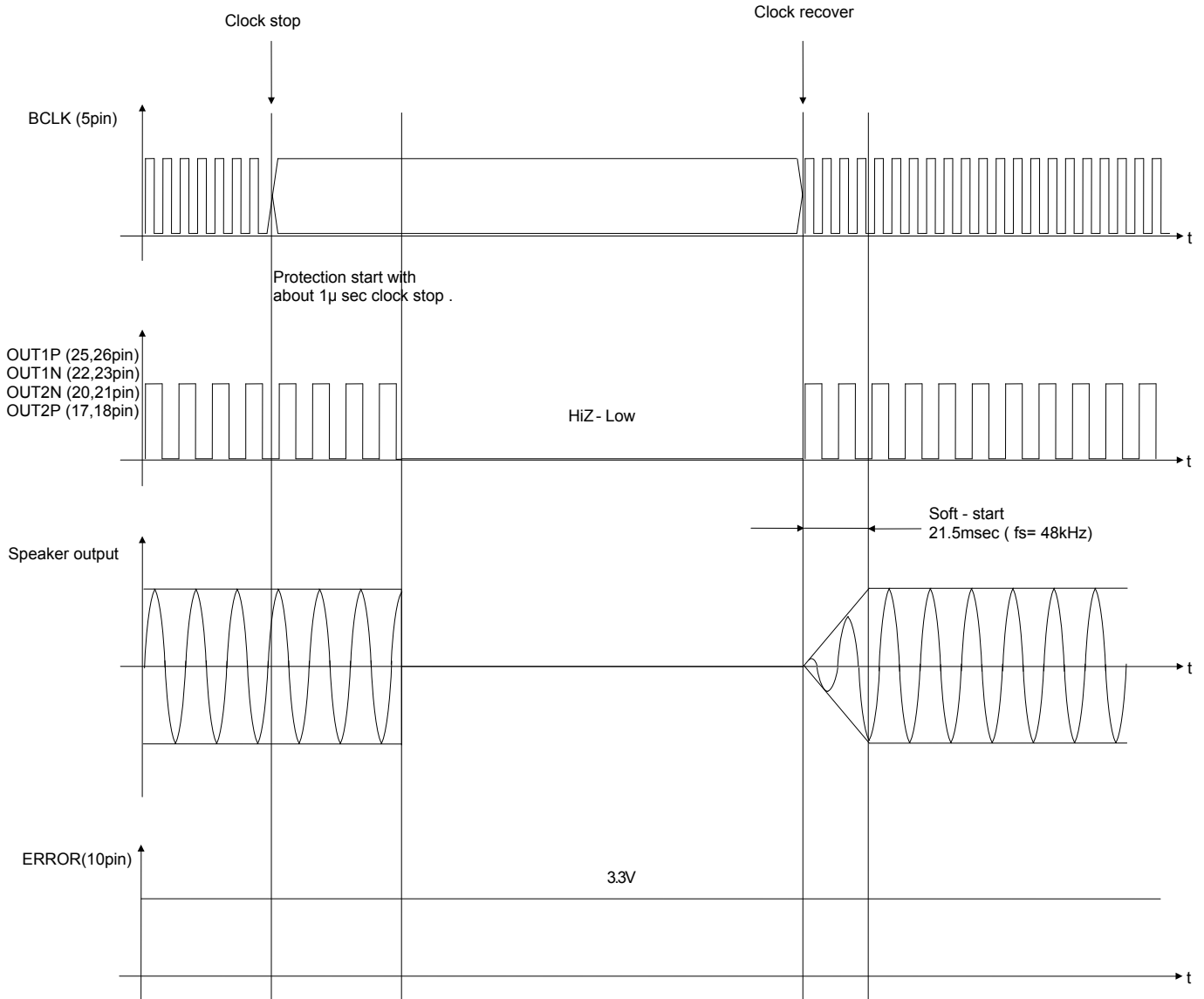

7-3) Clock stop protection (LRCLK)

This IC has the clock stop protection circuit that make the speaker output mute when the LRCLK signal of the digital audio input stops.

Detecting condition - It will detect when MUTEX pin is set High and the LRCLK signal stops for about 21 μ sec (at $f_s=48kHz$) or more. Speaker output turn MUTE immediately, when clock stop protection is detected.

Releasing condition - It will release when MUTEX pin is set High and the LRCLK signal returns to the normal clock operation. The speaker output is outputted through a soft-start when released.

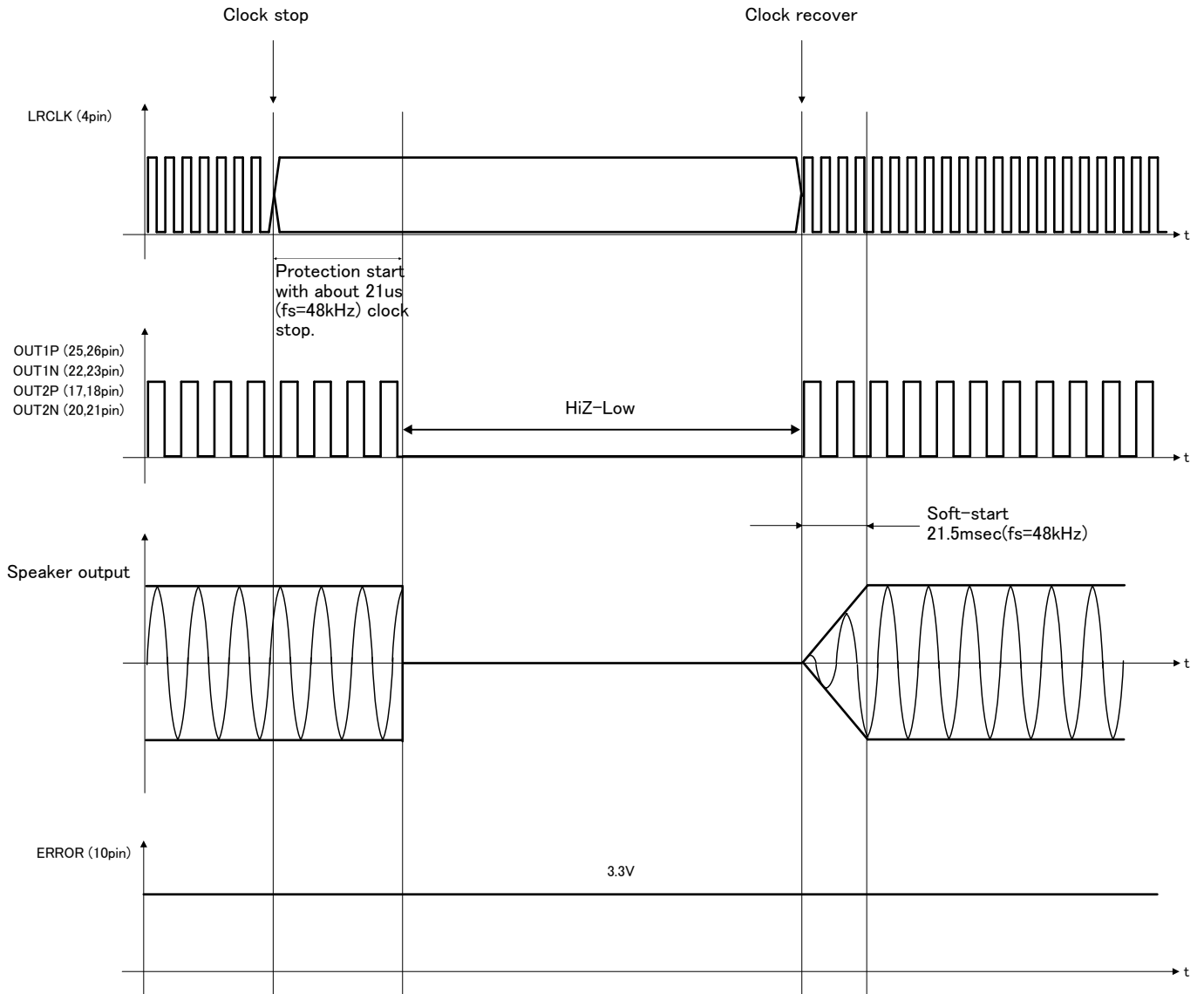

●Application Circuit Example (Stereo BTL Output, $R_L=8\Omega$, $V_{CC}=10V\sim 16V$, $P_o\sim 15W$)

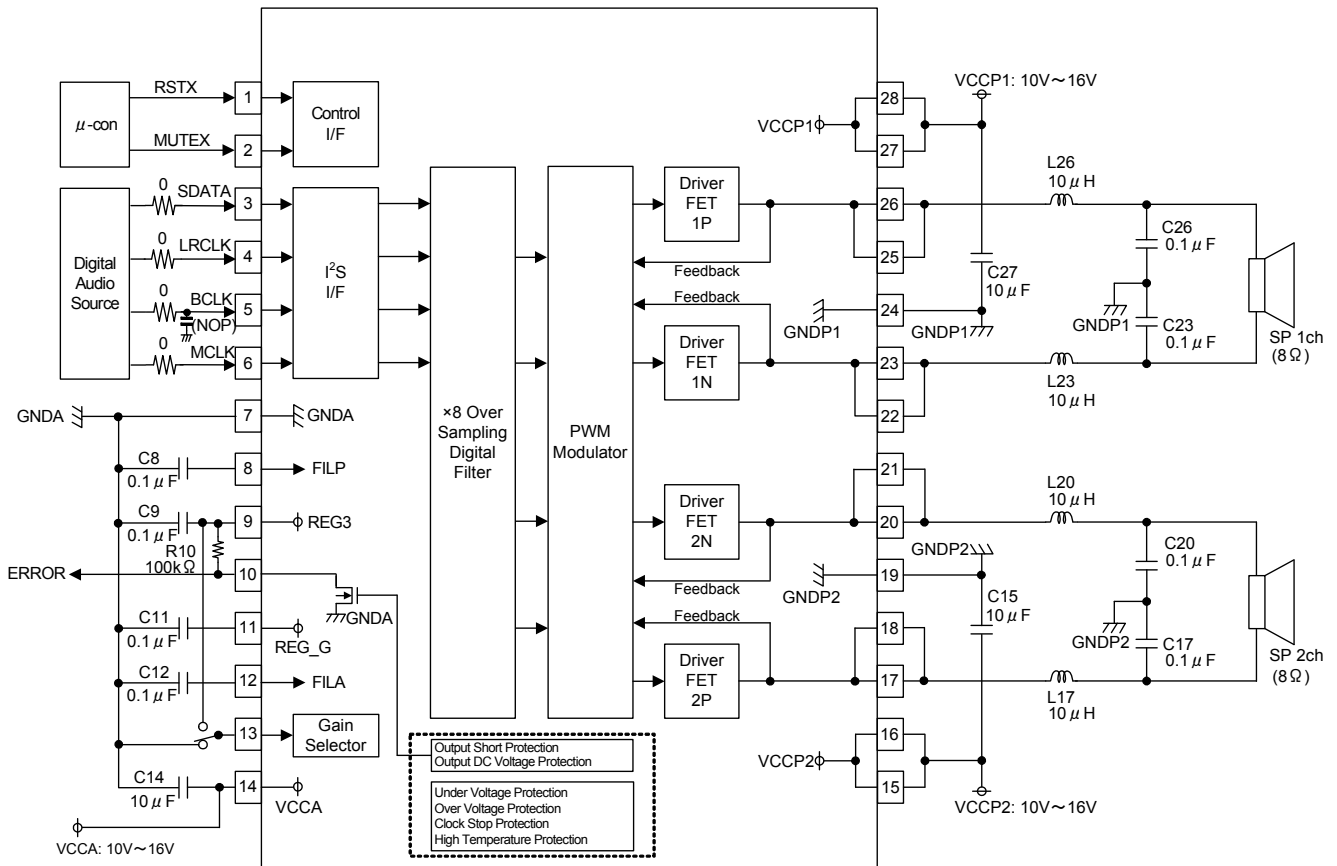

●BOM list (Stereo BTL Output, $R_L=8\Omega$, $V_{CC}=10V\sim 16V$, $P_o\sim 15W$)

| Parts | Parts No. | Value | Company | Product No. | Rated Voltage | Tolerance | Size |
|-----------|--------------------|---------------|---------|--------------------|---------------|-----------------|-------------|
| IC | U1 | — | ROHM | BD5451EFV | — | — | 9.7mm×6.4mm |
| Inductor | L17, L20, L23, L26 | 10 μ H | TOKO | B1047DS-100M=3P | — | ($\pm 20\%$) | 7.6mm×7.6mm |
| Resistor | R10 | 100k Ω | ROHM | MCR03EZPJ104 | 1/10W | J($\pm 1\%$) | 1.6mm×0.8mm |
| Capacitor | C14, C15, C27 | 10 μ F | MURATA | GRM31CB11E106KA75L | 25V | B($\pm 10\%$) | 3.2mm×1.6mm |
| | C8, C9, C11, C12 | 0.1 μ F | | GRM188B11A104KA92D | 10V | B($\pm 10\%$) | 1.6mm×0.8mm |
| | C17, C20, C23, C26 | 0.1 μ F | | GRM188B11E104KA01D | 25V | B($\pm 10\%$) | 1.6mm×0.8mm |

As return of current regenerated by back EMF of output coil happens, take steps such as putting capacitor between power supply and GND as a electric pathway for the regenerated current. Be sure that there is no problem with each property such as emptied capacity at lower temperature regarding electrolytic capacitor to decide capacity value. If the connected power supply does not have sufficient current absorption capacity, regenerative current will cause the voltage on the power supply line to rise, which combined with the product and its peripheral circuitry may exceed the absolute maximum ratings. It is recommended to implement a physical safety measure such as the insertion of a voltage clamp diode between the power supply and GND pins.

●Application Circuit Example (Monaural BTL Output, $R_L=8\Omega$, $V_{CC}=10V\sim 16V$, $P_o\sim 15W$)

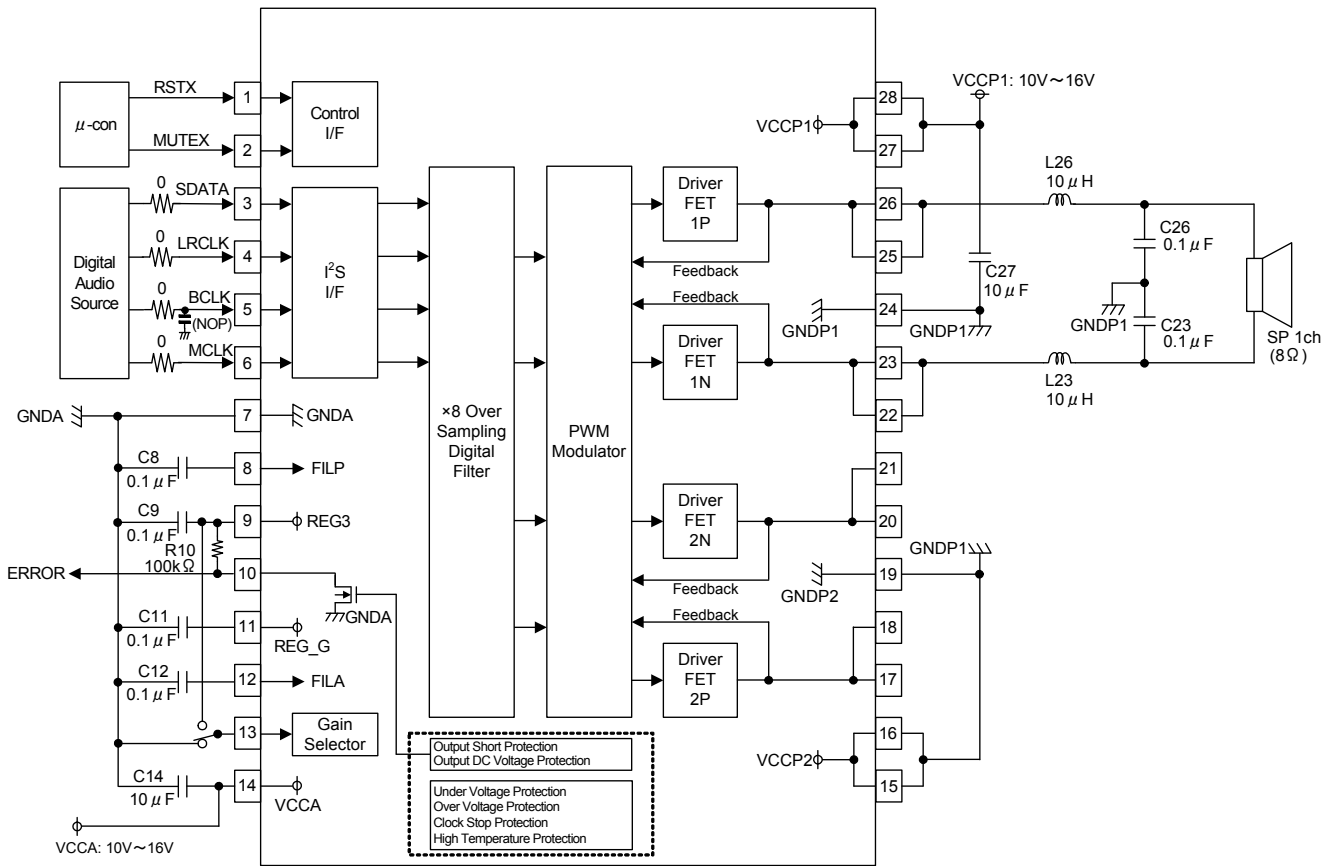

●BOM list (Monaural BTL Output, $R_L=8\Omega$, $V_{CC}=10V\sim 16V$, $P_o\sim 15W$)

| Parts | Parts No. | Value | Company | Product No. | Rated Voltage | Tolerance | Size |
|-----------|------------------|-------|---------|--------------------|---------------|-----------|-------------|
| IC | U1 | — | ROHM | BD5451EFV | — | — | 9.7mm×6.4mm |
| Inductor | L23, L26 | 10μH | TOKO | B1047DS-100M=3P | — | (±20%) | 7.6mm×7.6mm |
| Resistor | R10 | 100kΩ | ROHM | MCR03EZPJ104 | 1/10W | F(±1%) | 1.6mm×0.8mm |
| Capacitor | C14, C27 | 10μF | MURATA | GRM31CB11E106KA75L | 25V | B(±10%) | 3.2mm×1.6mm |
| | C8, C9, C11, C12 | 0.1μF | | GRM188B11A104KA92D | 10V | B(±10%) | 1.6mm×0.8mm |
| | C23, C26 | 0.1μF | | GRM188B11E104KA01D | 25V | B(±10%) | 1.6mm×0.8mm |

As return of current regenerated by back EMF of output coil happens, take steps such as putting capacitor between power supply and GND as a electric pathway for the regenerated current. Be sure that there is no problem with each property such as emptied capacity at lower temperature regarding electrolytic capacitor to decide capacity value. If the connected power supply does not have sufficient current absorption capacity, regenerative current will cause the voltage on the power supply line to rise, which combined with the product and its peripheral circuitry may exceed the absolute maximum ratings. It is recommended to implement a physical safety measure such as the insertion of a voltage clamp diode between the power supply and GND pins.

●Application Circuit Example (Stereo BTL Output, RL=8Ω, VCC=16V~18V, Po≈20W)

※To prevent going over absolute maximum rating by the leap out of power supply and the linking of PWM output wave form, please provide countermeasure shown below diagram (dot-line ※) when using at Vcc>16V.

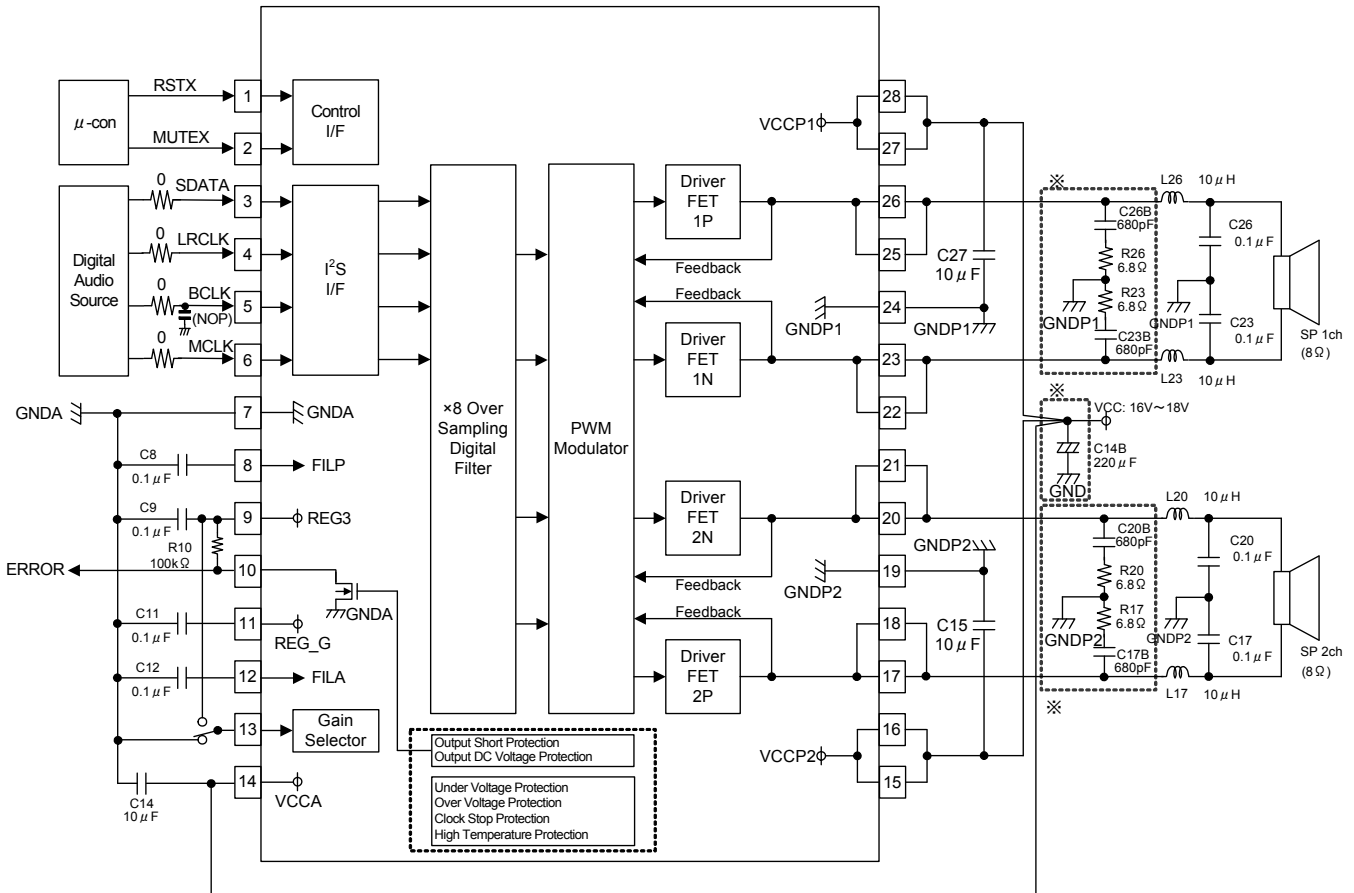

●BOM list (Stereo BTL Output, RL=8Ω, VCC=16V~18V, Po≈20W)

| Parts | Parts No. | Value | Company | Product No. | Rated Voltage | Tolerance | Size |
|------------------------|------------------------|-------|-----------|--------------------|---------------|-----------|-------------|
| IC | U1 | — | ROHM | BD5451EFV | — | — | 9.7mm×6.4mm |
| Inductor | L17, L20, L23, L26 | 10µH | TOKO | B1047DS-100M=3P | - | (±20%) | 7.6mm×7.6mm |
| Resistor | R10 | 100kΩ | ROHM | MCR03EZPJ104 | 1/10W | J(±5%) | 1.6mm×0.8mm |
| | R17, R20, R23, R26 | 6.8Ω | ROHM | MCR03EZPFL6R80 | 1/10W | F(±1%) | 1.6mm×0.8mm |
| Capacitor | C14, C15, C27 | 10µF | MURATA | GRM31CB11E106KA75L | 25V | B(±10%) | 3.2mm×1.6mm |
| | C8, C9, C11, C12 | 0.1µF | | GRM188B11A104KA92D | 10V | B(±10%) | 1.6mm×0.8mm |
| | C17, C20, C23, C26 | 0.1µF | | GRM188B11E104KA01D | 25V | B(±10%) | 1.6mm×0.8mm |
| | C17,B C20B, C23B, C26B | 680pF | | GRM188B11E681KA01 | 25V | B(±10%) | 1.6mm×0.8mm |
| Electrolytic Capacitor | C14B | 220µF | Panasonic | ECA1EMH221 | 25V | ±20% | φ8mm×11.5mm |

As return of current regenerated by back EMF of output coil happens, take steps such as putting capacitor between power supply and GND as a electric pathway for the regenerated current. Be sure that there is no problem with each property such as emptied capacity at lower temperature regarding electrolytic capacitor to decide capacity value. If the connected power supply does not have sufficient current absorption capacity, regenerative current will cause the voltage on the power supply line to rise, which combined with the product and its peripheral circuitry may exceed the absolute maximum ratings. It is recommended to implement a physical safety measure such as the insertion of a voltage clamp diode between the power supply and GND pins.

●Application Circuit Example (Monaural BTL Output, $R_L=8\Omega$, $V_{CC}=16V\sim 18V$, $P_o\sim 20W$)

※To prevent going over absolute maximum rating by the leap out of power supply and the linking of PWM output wave form, please provide countermeasure shown below diagram (dot-line ※) when using at $V_{CC}>16V$.

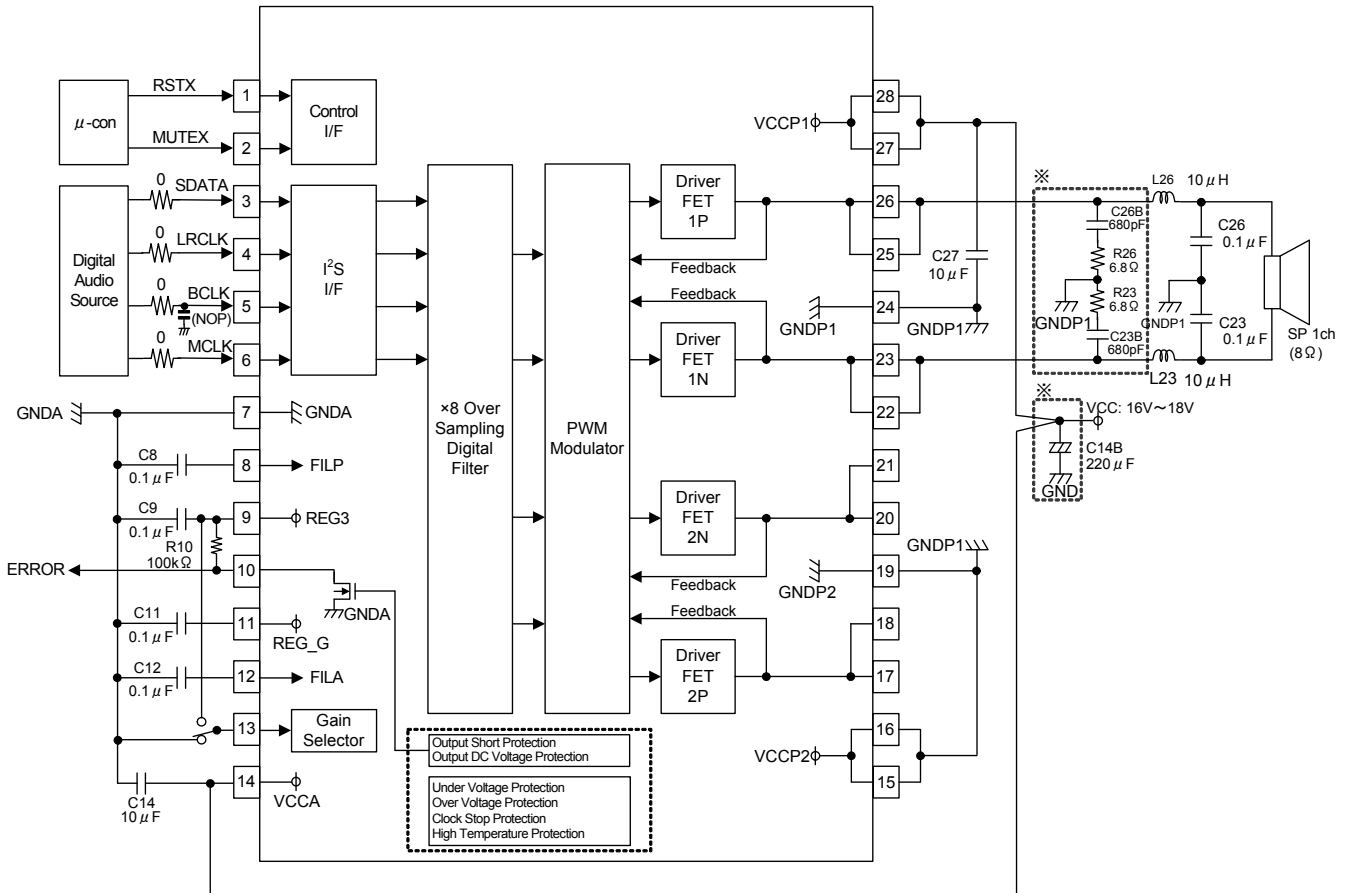

●BOM list (Monaural BTL Output, $R_L=8\Omega$, $V_{CC}=16V\sim 18V$, $P_o\sim 20W$)

| Parts | Parts No. | Value | Company | Product No. | Rated Voltage | Tolerance | Size |
|------------------------|------------------|-------|-----------|--------------------|---------------|-----------|-------------|
| IC | U1 | — | ROHM | BD5451EFV | — | — | 9.7mm×6.4mm |
| Inductor | L23, L26 | 10μH | TOKO | B1047DS-100M=P3 | — | (±20%) | 7.6mm×7.6mm |
| Resistor | R10 | 100kΩ | ROHM | MCR03EZPJ104 | 1/10W | J(±5%) | 1.6mm×0.8mm |
| | R23, R26 | 6.8Ω | | MCR03EZPFL6R80 | 1/10W | F(±1%) | 1.6mm×0.8mm |
| Capacitor | C14, C27 | 10μF | MURATA | GRM31CB31E106KA75L | 25V | B(±10%) | 3.2mm×1.6mm |
| | C8, C9, C11, C12 | 0.1μF | | GRM188B11A104KA92D | 10V | B(±10%) | 1.6mm×0.8mm |
| | C23, C26 | 0.1μF | | GRM188B11E104KA01D | 25V | B(±10%) | 1.6mm×0.8mm |
| | C23B, C26B | 680pF | | GRM188B11E681KA01 | 25V | B(±10%) | 1.6mm×0.8mm |
| Electrolytic Capacitor | C14B | 220μF | Panasonic | ECA1EMH221 | 25V | ±20% | φ8mm×11.5mm |

As return of current regenerated by back EMF of output coil happens, take steps such as putting capacitor between power supply and GND as a electric pathway for the regenerated current. Be sure that there is no problem with each property such as emptied capacity at lower temperature regarding electrolytic capacitor to decide capacity value. If the connected power supply does not have sufficient current absorption capacity, regenerative current will cause the voltage on the power supply line to rise, which combined with the product and its peripheral circuitry may exceed the absolute maximum ratings. It is recommended to implement a physical safety measure such as the insertion of a voltage clamp diode between the power supply and GND pins.

●Output LC Filter Circuit

An output filter is required to eliminate radio-frequency components exceeding the audio-frequency region supplied to a load (speaker). Because this IC uses sampling clock frequencies from 256kHz ($f_s=32\text{kHz}$) to 384kHz ($f_s=48\text{kHz}$) in the output PWM signals, the high-frequency components must be appropriately removed.

This section takes an example of an LC type LPF shown below, in which coil L and capacitor C compose a differential filter with an attenuation property of -12dB / oct . A large part of switching currents flow to capacitor C, and only a small part of the currents flow to speaker R_L . This filter reduces unwanted emission this way. In addition, coil L and capacitor Cg compose a filter against in-phase components, reducing unwanted emission further.

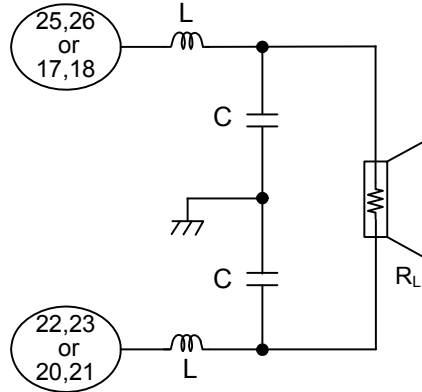

Following presents output LC filter constants with typical load impedances.

| R_L | L | C |
|-------------|-------------------|---------------------|
| $4\ \Omega$ | $10\ \mu\text{H}$ | $0.47\ \mu\text{F}$ |
| $6\ \Omega$ | $10\ \mu\text{H}$ | $0.15\ \mu\text{F}$ |
| $8\ \Omega$ | $10\ \mu\text{H}$ | $0.1\ \mu\text{F}$ |

Use coils with a low direct-current resistance and with a sufficient margin of allowable currents. A high direct-current resistance causes power losses. In addition, select a closed magnetic circuit type product in normal cases to prevent unwanted emission.

Use capacitors with a low equivalent series resistance, and good impedance characteristics at high frequency ranges (100kHz or higher). Also, select an item with sufficient withstand voltage because flowing massive amount of high-frequency currents is expected.

●Notes for use

- 1) Absolute maximum ratings
Use of the IC in excess of absolute maximum ratings such as the applied voltage or operating temperature range may result in IC damage. Assumptions should not be made regarding the state of the IC (short mode or open mode) when such damage is suffered. A physical safety measure such as a fuse should be implemented when use of the IC in a special mode where the absolute maximum ratings may be exceeded is anticipated.
- 2) Power supply lines
As return of current regenerated by back EMF of output coil happens, take steps such as putting capacitor between power supply and GND as a electric pathway for the regenerated current. Be sure that there is no problem with each property such as emptied capacity at lower temperature regarding electrolytic capacitor to decide capacity value. If the connected power supply does not have sufficient current absorption capacity, regenerative current will cause the voltage on the power supply line to rise, which combined with the product and its peripheral circuitry may exceed the absolute maximum ratings. It is recommended to implement a physical safety measure such as the insertion of a voltage clamp diode between the power supply and GND pins.
- 3) GND potential(Pin 7, 19, 24).
Any state must become the lowest voltage about GND terminal and VSS terminal.
- 4) Input terminal
The parasitic elements are formed in the IC because of the voltage relation. The parasitic element operating causes the wrong operation and destruction. Therefore, please be careful so as not to operate the parasitic elements by impressing to input terminals lower voltage than GND and VSS. Please do not apply the voltage to the input terminal when the power-supply voltage is not impressed.
- 5) Setting of heat
Use a thermal design that allows for a sufficient margin in light of the power dissipation (Pd) in actual operating conditions. This IC exposes its frame of the backside of package. Note that this part is assumed to use after providing heat dissipation treatment to improve heat dissipation efficiency. Try to occupy as wide as possible with heat dissipation pattern not only on the board surface but also the backside.
Class D speaker amplifier is high efficiency and low heat generation by comparison with conventional Analog power amplifier. However, In case it is operated continuously by maximum output power, Power dissipation (Pdiss) may exceed package dissipation. Please consider about heat design that Power dissipation (Pdiss) does not exceed Package dissipation (Pd) in average power (Poav). (Tjmax : Maximum junction temperature=150°C, Ta : Peripheral temperature[°C], θja : Thermal resistance of package[°C/W], Poav: Average power[W], η: Efficiency)
Package dissipation: $P_d (W) = (T_{jmax} - T_a) / \theta_{ja}$
Power dissipation : $P_{diss}(W) = P_{oav} \times (1/\eta - 1)$
- 6) Actions in strong magnetic field
Use caution when using the IC in the presence of a strong magnetic field as doing so may cause the IC to malfunction.
- 7) Thermal shutdown circuit
This product is provided with a built-in thermal shutdown circuit. When the thermal shutdown circuit operates, the output transistors are placed under open status. The thermal shutdown circuit is primarily intended to shut down the IC avoiding thermal runaway under abnormal conditions with a chip temperature exceeding Tjmax = 150°C.
- 8) Shorts between pins and misinstallation
When mounting the IC on a board, pay adequate attention to orientation and placement discrepancies of the IC. If it is misinstalled and the power is turned on, the IC may be damaged. It also may be damaged if it is shorted by a foreign substance coming between pins of the IC or between a pin and a power supply or a pin and a GND.
- 9) Power supply on/off (Pin 14, 15, 16, 27, 28)
In case power supply is started up, RSTX (Pin 1) and MUTEX (Pin 2) always should be set Low. And in case power supply is shut down, it should be set Low likewise. Then it is possible to eliminate pop noise when power supply is turned on/off. And also, all power supply terminals should start up and shut down together.
- 10) ERROR terminal(Pin 10)
A error flag is outputted when Output short protection and DC voltage protection in the speaker are operated. These flags are the function which the condition of this product is shown in.
- 11) Precautions for Spealer-setting
If the impedance characteristics of the speakers at high-frequency range while increase rapidly, the IC might not have stable-operation in the resonance frequency range of the LC-filter. Therefore, consider adding damping-circuit, etc., depending on the impedance of the speaker.
- 12) Notes about the phase of MCLK (Pin6) and BCLK (Pin5)
If the rising edge of MCLK (Pin6) and BCLK (Pin5) becomes simultaneous, noise or sound shutdown may occur. Please cope with it, when the rising edge of MCLK and BCLK becomes simultaneous. (Example: Insert RC filter in BCLK)

●Package outline (HTSSOP-B28)

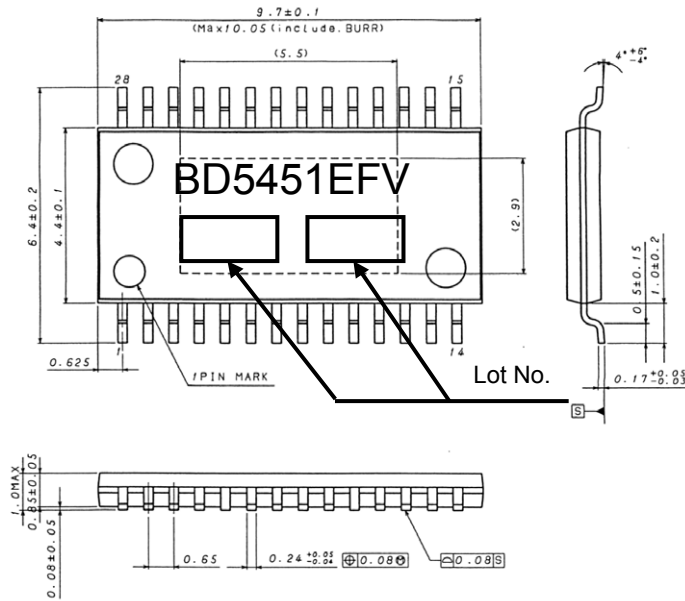

(UNIT: mm)
 PKG: HTSSOP-B28
 Drawing No: EX199-5002-1

●Allowable Power Dissipation

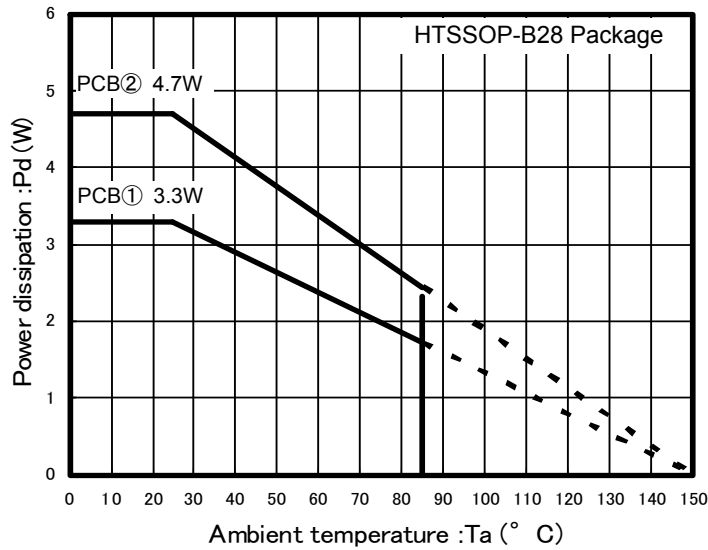

Measuring instrument: TH-156(Shibukawa Kuwano Electrical Instruments Co., Ltd.)

Measuring conditions: Installation on ROHM's board

Board size: 70mm×70mm×1.6mm(with thermal via on board)

Material: FR4

• The board on exposed heat sink on the back of package are connected by soldering.

PCB①: 2-layer board(back copper foil size: 70mm×70mm), $\theta_{ja}=37.9^{\circ}\text{C}/\text{W}$

PCB②: 4-layer board(back copper foil size: 70mm×70mm), $\theta_{ja}=26.6^{\circ}\text{C}/\text{W}$

●Ordering part number

| | |
|---|---|
| B | D |
|---|---|

Part No.

| | | | |
|---|---|---|---|
| 5 | 4 | 5 | 1 |
|---|---|---|---|

Part No.

| | | |
|---|---|---|
| E | F | V |
|---|---|---|

Package
EFV: HTSSOP-B28

| | |
|---|---|
| E | 2 |
|---|---|

Packaging and forming specification
E2: Embossed tape and reel

HTSSOP-B28

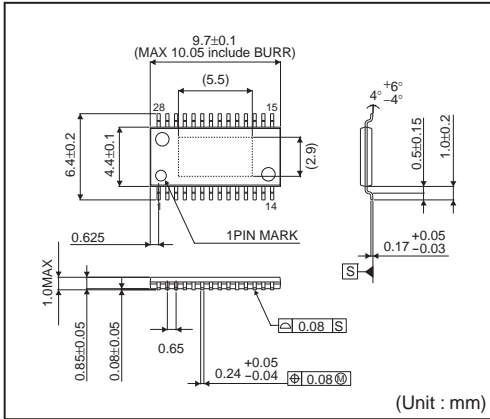

<Tape and Reel information>

| | |
|-------------------|--|
| Tape | Embossed carrier tape (with dry pack) |
| Quantity | 2500pcs |
| Direction of feed | E2 (The direction is the 1 pin of product is at the upper left when you hold reel on the left hand and you pull out the tape on the right hand) |

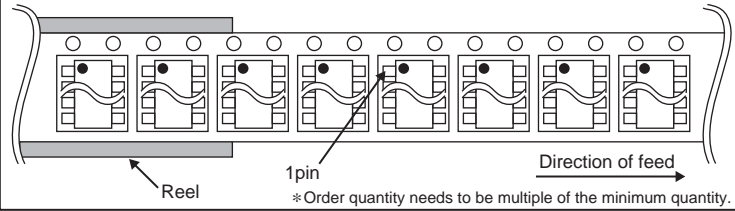

Notes

No copying or reproduction of this document, in part or in whole, is permitted without the consent of ROHM Co.,Ltd.

The content specified herein is subject to change for improvement without notice.

The content specified herein is for the purpose of introducing ROHM's products (hereinafter "Products"). If you wish to use any such Product, please be sure to refer to the specifications, which can be obtained from ROHM upon request.

Examples of application circuits, circuit constants and any other information contained herein illustrate the standard usage and operations of the Products. The peripheral conditions must be taken into account when designing circuits for mass production.

Great care was taken in ensuring the accuracy of the information specified in this document. However, should you incur any damage arising from any inaccuracy or misprint of such information, ROHM shall bear no responsibility for such damage.

The technical information specified herein is intended only to show the typical functions of and examples of application circuits for the Products. ROHM does not grant you, explicitly or implicitly, any license to use or exercise intellectual property or other rights held by ROHM and other parties. ROHM shall bear no responsibility whatsoever for any dispute arising from the use of such technical information.

The Products specified in this document are intended to be used with general-use electronic equipment or devices (such as audio visual equipment, office-automation equipment, communication devices, electronic appliances and amusement devices).

The Products specified in this document are not designed to be radiation tolerant.

While ROHM always makes efforts to enhance the quality and reliability of its Products, a Product may fail or malfunction for a variety of reasons.

Please be sure to implement in your equipment using the Products safety measures to guard against the possibility of physical injury, fire or any other damage caused in the event of the failure of any Product, such as derating, redundancy, fire control and fail-safe designs. ROHM shall bear no responsibility whatsoever for your use of any Product outside of the prescribed scope or not in accordance with the instruction manual.

The Products are not designed or manufactured to be used with any equipment, device or system which requires an extremely high level of reliability the failure or malfunction of which may result in a direct threat to human life or create a risk of human injury (such as a medical instrument, transportation equipment, aerospace machinery, nuclear-reactor controller, fuel-controller or other safety device). ROHM shall bear no responsibility in any way for use of any of the Products for the above special purposes. If a Product is intended to be used for any such special purpose, please contact a ROHM sales representative before purchasing.

If you intend to export or ship overseas any Product or technology specified herein that may be controlled under the Foreign Exchange and the Foreign Trade Law, you will be required to obtain a license or permit under the Law.



Thank you for your accessing to ROHM product informations.
More detail product informations and catalogs are available, please contact us.

ROHM Customer Support System

<http://www.rohm.com/contact/>