

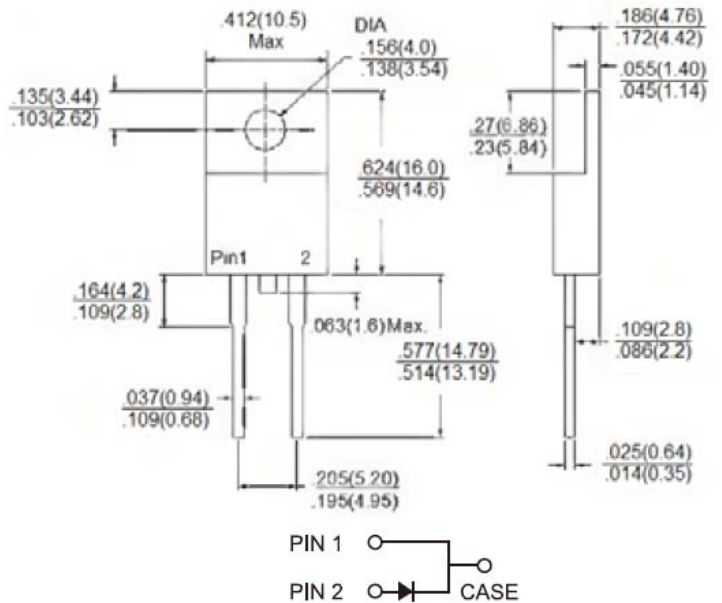

Features

- ✧ Low power loss, high efficiency
- ✧ High current capability, low VF
- ✧ High reliability
- ✧ High surge current capability
- ✧ Epitaxial construction
- ✧ Guard-ring for transient protection
- ✧ For use in low voltage, high frequency inverter, free wheeling, and polarity protection application
- ✧ Green compound with suffix "G" on packing code & prefix "G" on datecode



Mechanical Data

- ✧ Case: TO-220AC molded plastic
- ✧ Epoxy: UL 94V-0 rate flame retardant
- ✧ Terminals: Pure tin plated, lead free, solderable per MIL-STD-202, Method 208 guaranteed
- ✧ Polarity: As marked
- ✧ High temperature soldering guaranteed: 260°C / 10 seconds / .25", (6.35mm) from case
- ✧ Weight: 1.87 gram

Dimensions in inches and (millimeters)

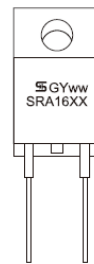

Marking Diagram

- SRA16XX = Specific Device Code
- G = Green Compound
- Y = Year
- WW = Work Week

Maximum Ratings and Electrical Characteristics

Rating at 25 °C ambient temperature unless otherwise specified.
Single phase, half wave, 60 Hz, resistive or inductive load.
For capacitive load, derate current by 20%

Type Number	Symbol	SRA 1620	SRA 1630	SRA 1640	SRA 1650	SRA 1660	SRA 1690	SRA 16100	Unit
Maximum Repetitive Peak Reverse Voltage	V_{RRM}	20	30	40	50	60	90	100	V
Maximum RMS Voltage	V_{RMS}	14	21	28	35	42	63	70	V
Maximum DC Blocking Voltage	V_{DC}	20	30	40	50	60	90	100	V
Maximum Average Forward Rectified Current	$I_{F(AV)}$	16							A
Peak Forward Surge Current, 8.3 ms Single Half Sine-wave Superimposed on Rated Load (JEDEC method)	I_{FSM}	200							A
Maximum Instantaneous Forward Voltage (Note 1) @ 16A	V_F	0.55		0.70		0.92		V	
Maximum Reverse Current @ Rated VR $T_A=25^\circ C$ $T_A=100^\circ C$ $T_A=125^\circ C$	I_R	0.5					0.1		mA
		15		10		-			
		-					5		
Typical Junction Capacitance (Note 2)	C_j	700		550		480		pF	
Typical Thermal Resistance	$R_{\theta JC}$	5							°C/W
Operating Temperature Range	T_J	- 65 to + 125			- 65 to + 150				°C
Storage Temperature Range	T_{STG}	- 65 to + 150							°C

Note 1 : Pulse Test : 300 usec Pulse Width, 1% Duty Cycle

Note 2 : Measure at 1MHz and Applied Reverse Voltage of 4.0V D.C.

RATINGS AND CHARACTERISTIC CURVES (SRA1620 THRU SRA16100)

FIG. 1 FORWARD CURRENT DERATING CURVE

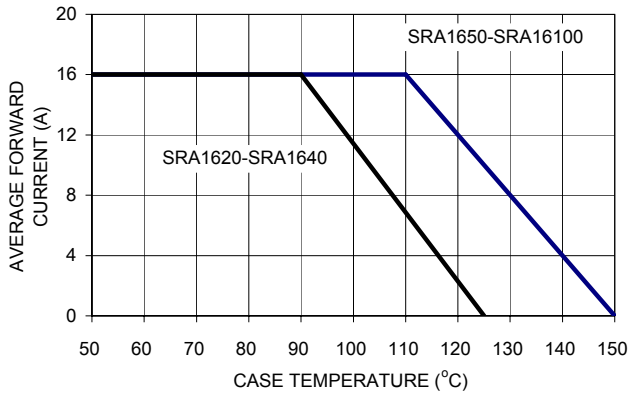

FIG. 2 MAXIMUM NON-REPETITIVE FORWARD SURGE CURRENT

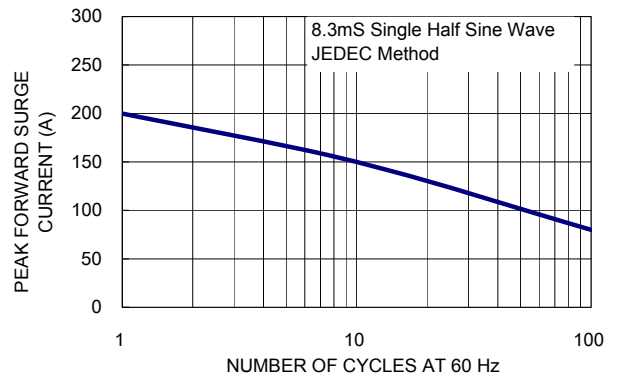

FIG. 3 TYPICAL FORWARD CHARACTERISTICS

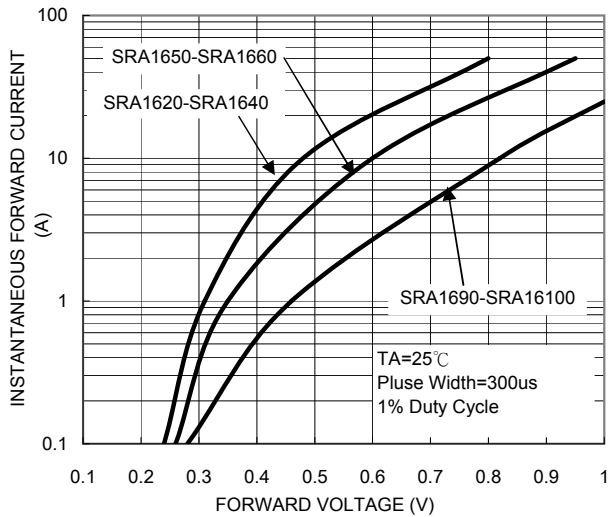

FIG. 4 TYPICAL REVERSE CHARACTERISTICS

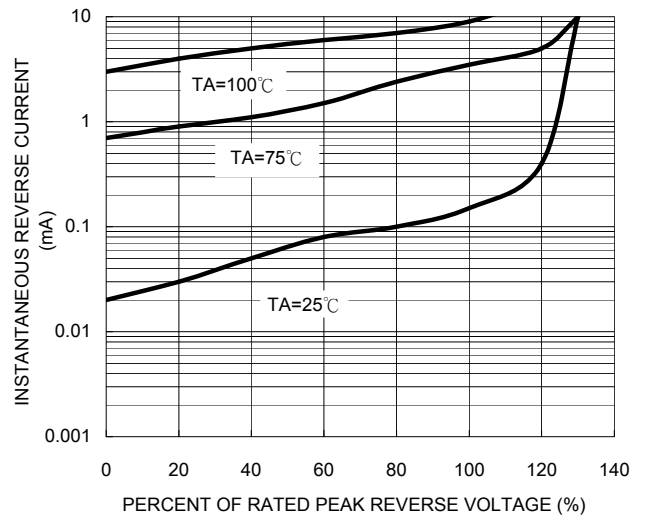

FIG. 5 TYPICAL JUNCTION CAPACITANCE

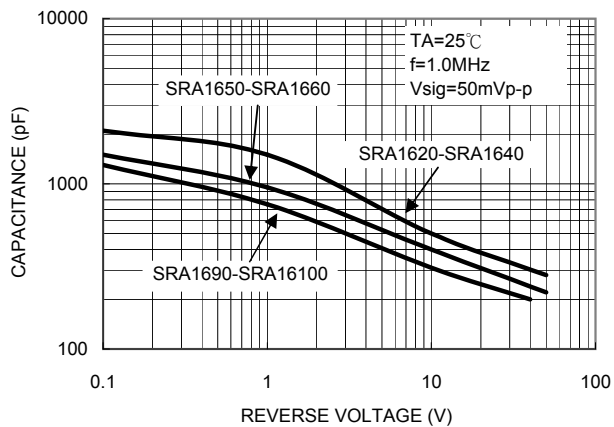

FIG. 6 TYPICAL TRANSIENT THERMAL IMPEDANCE

