

## 25x25x2 Ceramic Patch Antenna (Standard)

### 1. Explanation of Product Number

H	2	P	1	3	B	A	A	A	B	0	1	0	0
				(1)	(2)	(3)	(4)	(5)	(6)				



**Product Code:**

(1) Product Categories:

3: ceramic patch antenna

(2) Dimensions and Polarization:

BA: 25x25x02 (mm)/right hand circular polarization

(3) Material:

A: MA-PC

(4) Working Frequency:

A: 1575.42MHz

(5) Ground Plane Dimensions:

B: 70x70(mm)

(6) Antenna Series:

01: serial number

<b>Tolerances (Unless otherwise specified)</b> X : ± 1      X.X : ± 0.1      X.XX : ± 0.01 Angle : ±                      Hole Dia. : ±		Unictron Technologies Corporation Website: www.unictron.com		
Scale :	Unit : mm	<b>2010-08-04</b>		
Prepared By : Meiping	Checked By : Chinling	THIS SPECIFICATION IS THE PROPERTY OF UNICTRON TECHNOLOGIES CORPORATION AND SHALL NOT BE REPRODUCED OR USED IN ALL CIRCUMSTANCES WITHOUT WRITTEN PERMISSION		
Designed By : Chinling	Approved By : Herbert			
<b>TITLE : 25*25*2 Ceramic Patch Antenna (Standard)</b>		DOCUMENT NO.	<b>H2P13BAAAB0100</b>	REV. <b>D</b>

## 2. Features

- \*Stable and reliable in performances
- \*Low temperature coefficient of frequency
- \*Compact size
- \*RoHS compliance

## 3. Applications

- \*Navigation systems or position tracking systems
- \*Hand-held devices when GPS function is needed, e.g., PDA, Smart phone, PND.

## 4. Description

Unictron's patch antenna series are ceramic antennas specially designed for GPS application. This ceramic patch antenna has excellent stability and sensitivity through the use of high performance proprietary ceramic materials and processes.

## 5. Electrical Specifications (70x70(mm) ground plane)

Characteristics		Specifications	Unit
Outline Dimensions		25×25×2	mm
Ground Plane		70×70	mm
Center Frequency*		1581±2	MHz
Bandwidth (under -10dB return loss)		10 min.	MHz
VSWR		1.5 max.	
Impedance		50	Ω
Polarization		RHCP	
Gain	@Zenith	+4.5 (typical)	dBic
	@10° Elevation	-3.0 (typical)	
Axial Ratio		3 (typical)	dB
Temperature Coefficient of Frequency		0±20 max (@ -40°C ~80°C)	ppm/°C

\*Center frequency will be offset to working frequency according to the conditions of user's ground plane and radome.

### Tolerances (Unless otherwise specified)

X : ± 1      X.X : ± 0.1      X.XX : ± 0.01

Angle : ±      Hole Dia. : ±



Unictron Technologies Corporation  
Website: www.unictron.com

Scale :      Unit : mm

Prepared By : Meiping      Checked By : Chinling

Designed By : Chinling      Approved By : Herbert

THIS SPECIFICATION IS THE PROPERTY OF UNICTRON TECHNOLOGIES CORPORATION AND SHALL NOT BE REPRODUCED OR USED IN ALL CIRCUMSTANCES WITHOUT WRITTEN PERMISSION

**TITLE : 25\*25\*2 Ceramic Patch Antenna  
(Standard)**

**DOCUMENT  
NO.**

**H2P13BAAAB0100**

REV.

**D**

## 6. Antenna Dimensions (unit: mm)

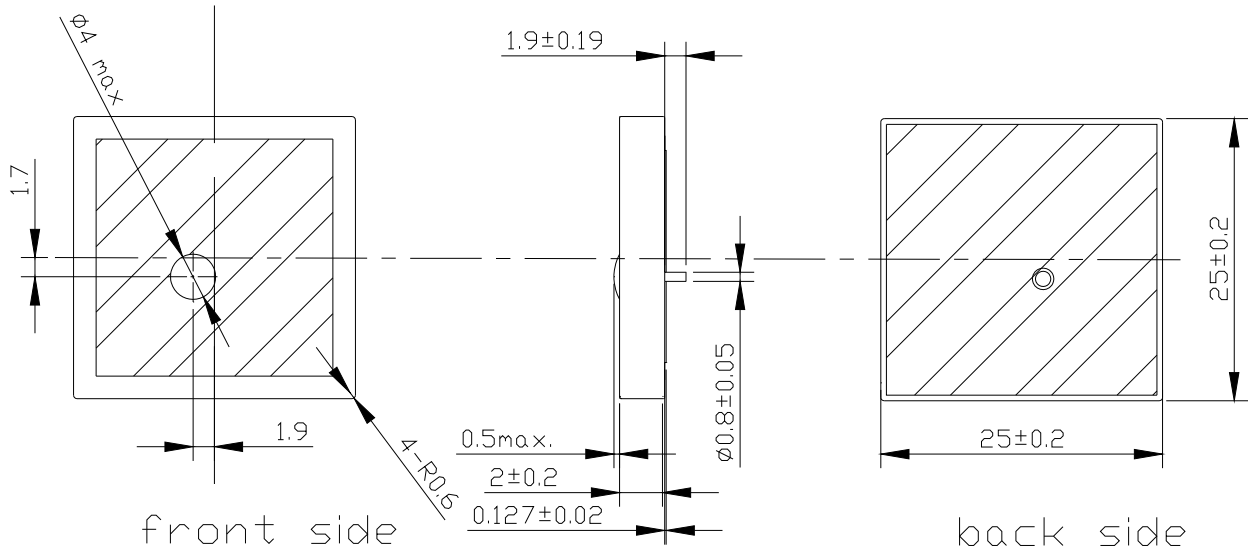

## 7. Electrical Characteristics (70x70(mm) ground plane)

Return Loss( $S_{11}$ )

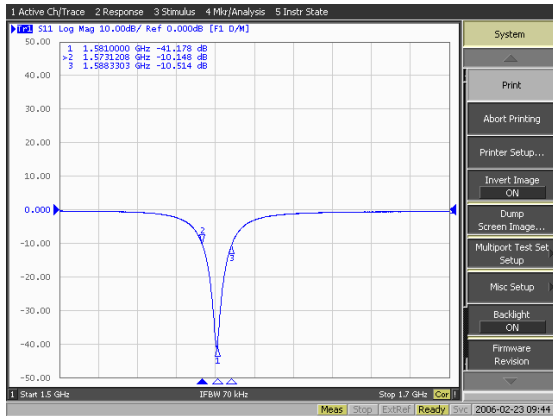

Smith Chart

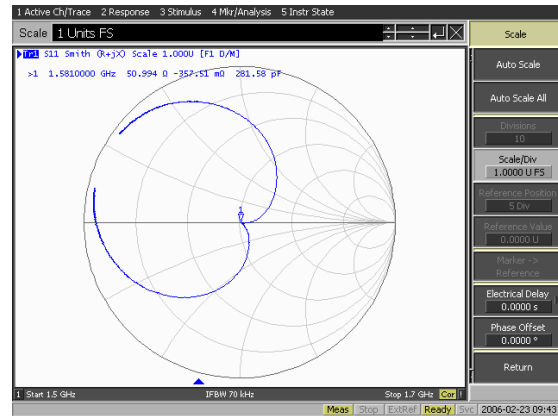

### Tolerances (Unless otherwise specified)

X :  $\pm 1$       X.X :  $\pm 0.1$       X.XX :  $\pm 0.01$

Angle :  $\pm$       Hole Dia. :  $\pm$



Unictron Technologies Corporation  
Website: www.unictron.com

Scale :      Unit : mm

Prepared By : Meiping      Checked By : Chinling

Designed By : Chinling      Approved By : Herbert

THIS SPECIFICATION IS THE PROPERTY OF UNICTRON TECHNOLOGIES CORPORATION AND SHALL NOT BE REPRODUCED OR USED IN ALL CIRCUMSTANCES WITHOUT WRITTEN PERMISSION

TITLE : 25\*25\*2 Ceramic Patch Antenna (Standard)

DOCUMENT NO.

H2P13BAAAB0100

REV.

D

## 8. Axial Ratio (70x70(mm) ground plane)

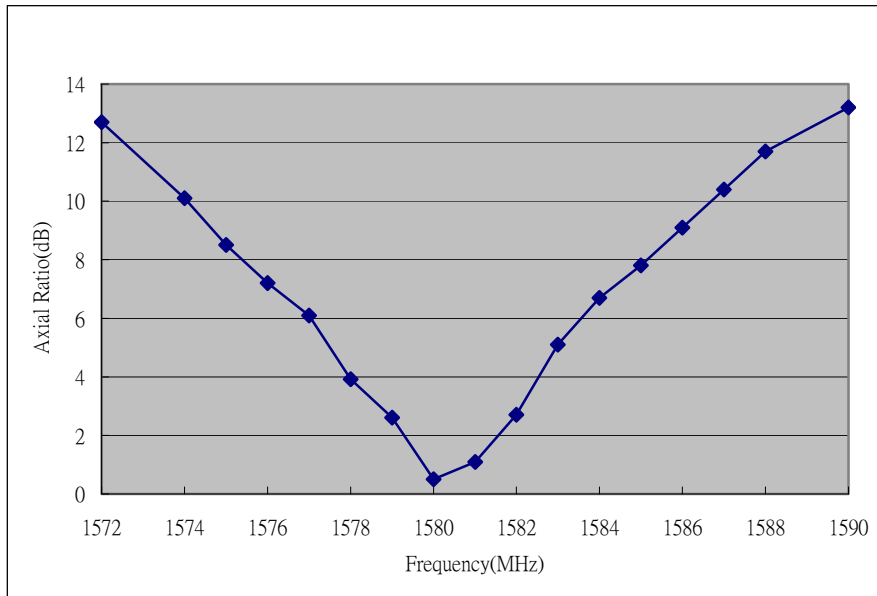

## 9. Gain vs. Ground Plane Size

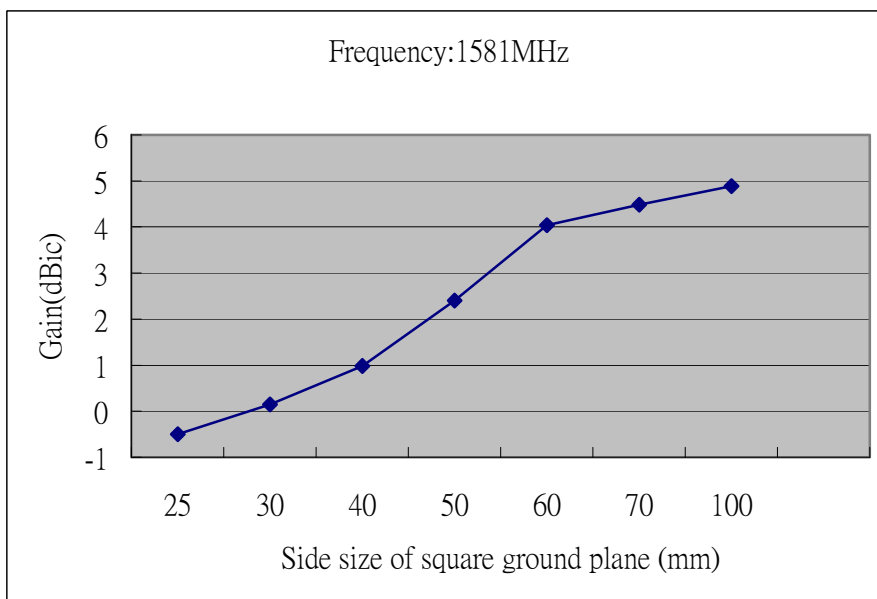

**Tolerances (Unless otherwise specified)**

X : ± 1      X.X : ± 0.1      X.XX : ± 0.01

Angle : ±

Hole Dia. : ±



Unictron Technologies Corporation  
Website: www.unictron.com

Scale :

Unit : mm

2010-08-04

Prepared By : Meiping

Checked By :  
Chinling

THIS SPECIFICATION IS THE PROPERTY OF UNICTRON TECHNOLOGIES CORPORATION AND SHALL NOT BE REPRODUCED OR USED IN ALL CIRCUMSTANCES WITHOUT WRITTEN PERMISSION

Designed By : Chinling

Approved By :  
Herbert

**TITLE : 25\*25\*2 Ceramic Patch Antenna  
(Standard)**

**DOCUMENT  
NO.**

**H2P13BAAAB0100**

REV.

**D**

# 10. Radiation Pattern (70x70(mm) ground plane)

0°

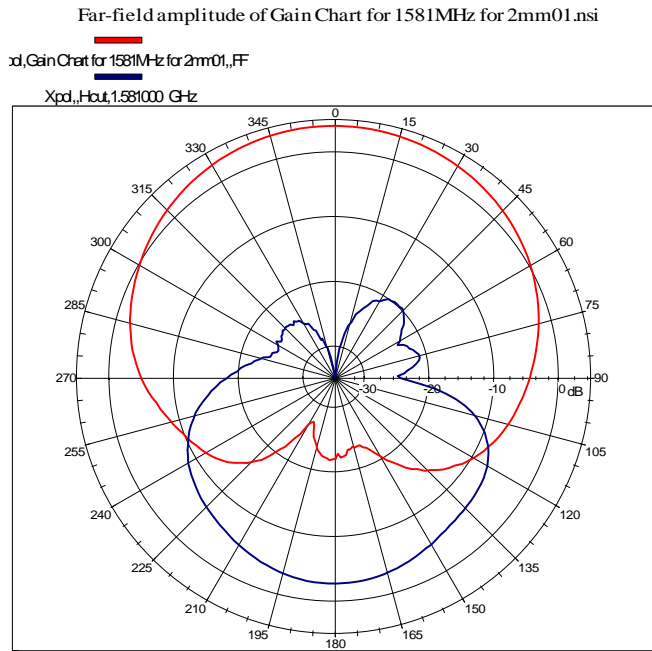

90°

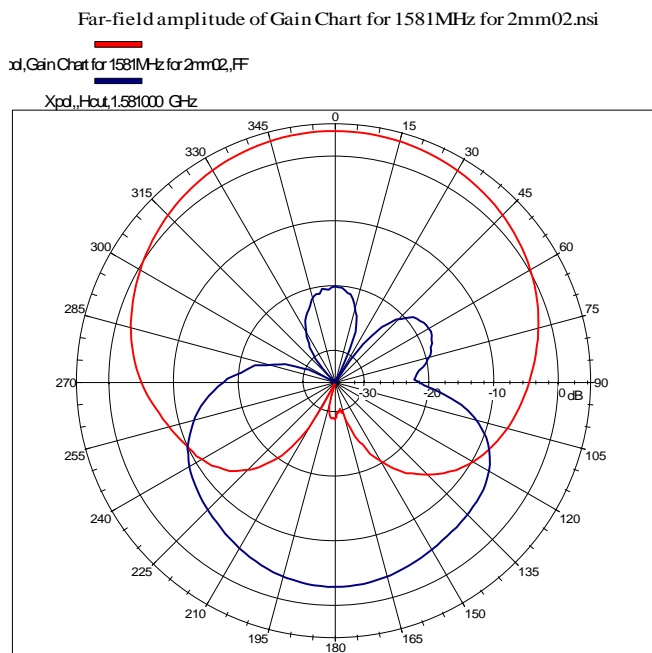

Right hand circular polarized signal  $f_0=1581\text{MHz}$

<b>Tolerances (Unless otherwise specified)</b> X : ± 1      X.X : ± 0.1      X.XX : ± 0.01 Angle : ±      Hole Dia. : ±		 Unictron Technologies Corporation Website: www.unictron.com	2010-08-04 THIS SPECIFICATION IS THE PROPERTY OF UNICTRON TECHNOLOGIES CORPORATION AND SHALL NOT BE REPRODUCED OR USED IN ALL CIRCUMSTANCES WITHOUT WRITTEN PERMISSION	
Scale :	Unit : mm			
Prepared By : Meiping	Checked By : Chinling			
Designed By : Chinling	Approved By : Herbert			
<b>TITLE : 25*25*2 Ceramic Patch Antenna (Standard)</b>		DOCUMENT NO.	H2P13BAAAB0100	REV. D