

## HIGH POWERED MULTI-LINE TVS ARRAY

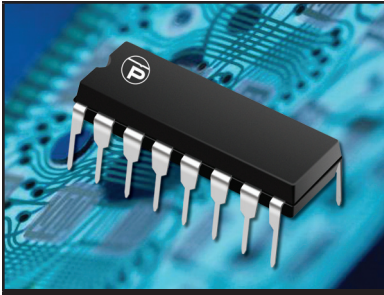

**16 PIN DIP PACKAGE**

### DESCRIPTION

The DA16 Series are high powered multi-line TVS arrays available in a 16 pin DIP package. This series is designed to protect monitoring and industrial equipment from the damaging effects of ESD, EFT and secondary transient threats.

The DA16 Series has a peak pulse power rating of 800 Watts for an 8/20 $\mu$ s waveshape. This devices meets the IEC 61000-4-2, IEC 61000-4-4 and IEC 61000-4-5 requirements.

### FEATURES

- Compatible with IEC 61000-4-2 (ESD): Air - 15kV, Contact - 8kV
- Compatible with IEC 61000-4-4 (EFT): 40A - 5/50ns
- Compatible with IEC 61000-4-5 (Surge): 24A, 8/20 $\mu$ s - Level 2(Line-Gnd) & Level 3(Line-Line)
- 800 Watts Peak Pulse Power per Line (tp = 8/20 $\mu$ s)
- Unidirectional & Bidirectional Configurations
- ESD Protection > 25 kilovolts
- Available in Multiple Voltages
- Protects 8 to 12 Lines
- RoHS Compliant
- REACH Compliant

### APPLICATIONS

- Low Frequency I/O Ports
- RS-232 & RS-423 Data Lines
- Power Bus Lines
- Monitoring & Industrial Signal & Data Ports
- Microprocessor Based Equipment

### MECHANICAL CHARACTERISTICS

- Molded 16 Pin Dual-In-Line (DIP) Package
- Approximate Weight: 1.2 grams
- Lead-Free Pure-Tin Plating (Annealed)
- Solder Reflow Temperature:  
Pure-Tin - Sn, 100: 260-270°C
- Flammability Rating UL 94V-0

## PIN CONFIGURATIONS

### UNIDIRECTIONAL

#### DAxxN Series

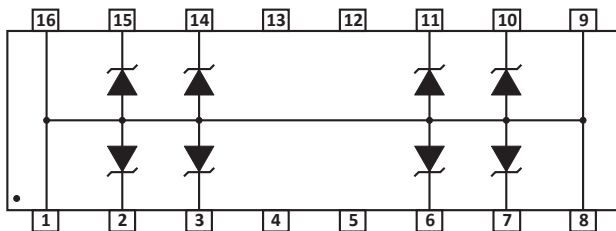

#### DAxxP Series

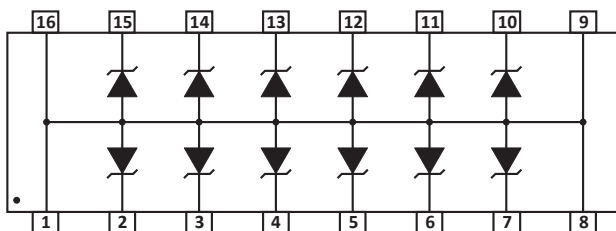

### BIDIRECTIONAL

#### DAxxCN Series

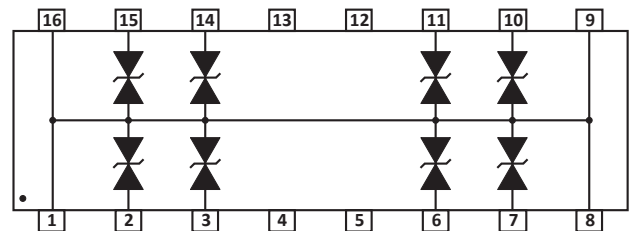

#### DAxxCP Series

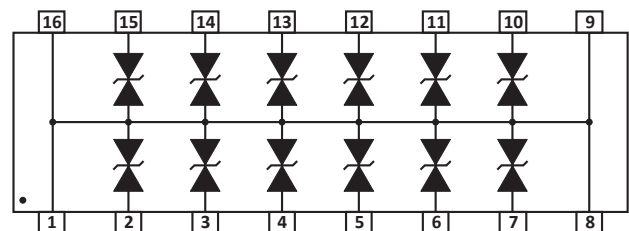

**TYPICAL DEVICE CHARACTERISTICS**
**MAXIMUM RATINGS @ 25°C Unless Otherwise Specified**

PARAMETER	SYMBOL	VALUE	UNITS
Peak Pulse Power (tp = 8/20μs) - See Figure 1	P <sub>PP</sub>	800	Watts
Operating Temperature	T <sub>L</sub>	-55 to 150	°C
Storage Temperature	T <sub>STG</sub>	-55 to 150	°C
Forward Surge Rating	I <sub>F</sub>	10	Amps

**ELECTRICAL CHARACTERISTICS PER LINE @ 25°C Unless Otherwise Specified**

PART NUMBER (Note 1)	RATED STAND-OFF VOLTAGE	MINIMUM BREAKDOWN VOLTAGE	MAXIMUM CLAMPING VOLTAGE (Fig. 2)	MAXIMUM CLAMPING VOLTAGE (Fig. 2)	MAXIMUM LEAKAGE CURRENT	TYPICAL CAPACITANCE
	V <sub>WM</sub> VOLTS	@1mA V <sub>(BR)</sub> VOLTS	@ IP = 10A V <sub>C</sub> VOLTS	@ 8/20μs V <sub>C</sub> @ I <sub>PP</sub>	@V <sub>WM</sub> I <sub>D</sub> μA	@0V, 1MHz C pF
DA05N	5.0	6.0	12.5	24.6V @ 45.0A	200	880
DA05P	5.0	6.0	12.5	24.6V @ 45.0A	200	880
DA05CN	5.0	6.0	12.5	24.6V @ 45.0A	200	500
DA05CP	5.0	6.0	12.5	24.6V @ 45.0A	200	500
DA12N	12.0	13.3	26.0	32.9V @ 34.0A	2	440
DA12P	12.0	13.3	26.0	32.9V @ 34.0A	2	440
DA12CN	12.0	13.3	26.0	32.9V @ 34.0A	2	385
DA12CP	12.0	13.3	26.0	32.9V @ 34.0A	2	385
DA15N	15.0	16.7	33.0	37.7V @ 27.0A	2	400
DA15P	15.0	16.7	33.0	37.7V @ 27.0A	2	400
DA15CN	15.0	16.7	33.0	37.7V @ 27.0A	2	300
DA15CP	15.0	16.7	33.0	37.7V @ 27.0A	2	300
DA24N	24.0	26.7	52.1	53.0V @ 20.0A	2	275
DA24P	24.0	26.7	52.1	53.0V @ 20.0A	2	275
DA24CN	24.0	26.7	52.1	53.0V @ 20.0A	2	200
DA24CP	24.0	26.7	52.1	53.0V @ 20.0A	2	200

**NOTES**

1. The "C" suffix denotes a bidirectional device, such as DA05CN.

TYPICAL DEVICE CHARACTERISTICS

FIGURE 1  
PEAK PULSE POWER VS PULSE TIME

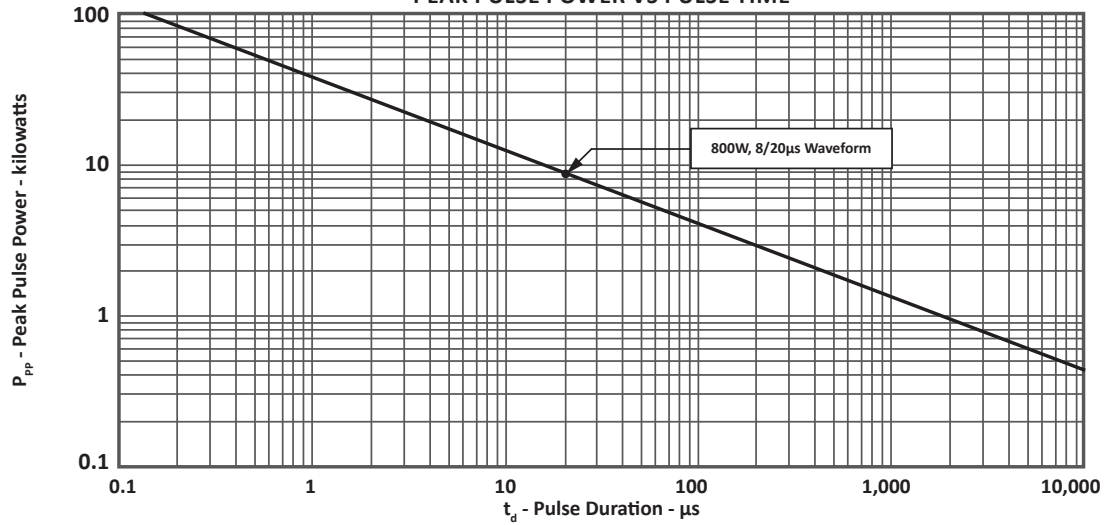

FIGURE 2  
PULSE WAVE FORM

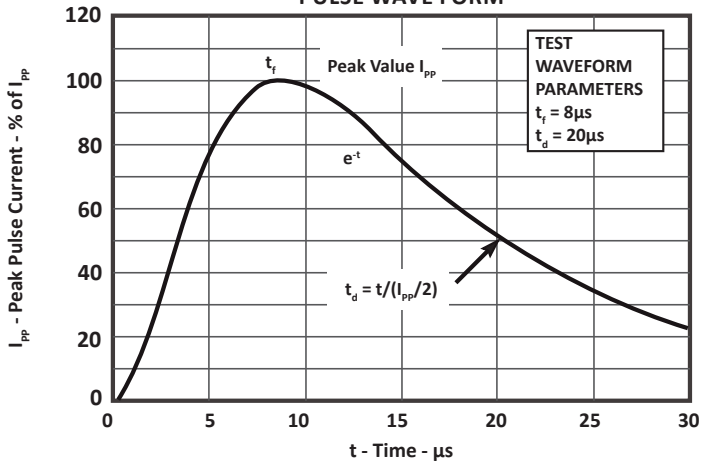
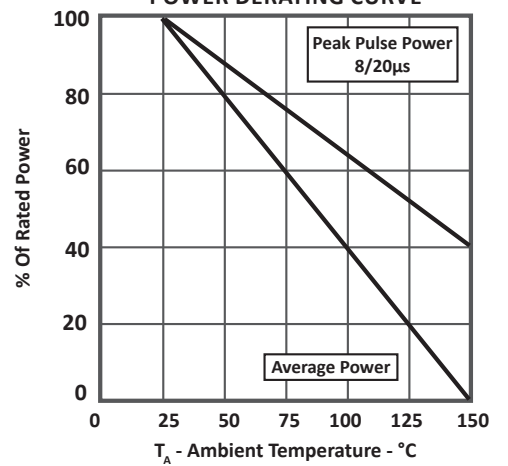

FIGURE 3  
POWER DERATING CURVE



## 16 PIN DIP PACKAGE INFORMATION

### OUTLINE DIMENSIONS

DIM	MILLIMETERS		INCHES	
	MIN	MAX	MIN	MAX
A	18.80	19.55	0.740	0.770
B	6.35	6.85	0.250	0.270
C	7.50	7.74	0.295	0.305
D	0.21	0.38	0.008	0.015
E	0°	10°	0°	10°
F	0.51	1.01	0.020	0.040
G	3.69	4.44	0.145	0.175
H	2.80	3.30	0.110	0.130
I	1.02	1.77	0.040	0.070
J	1.27	1.27	0.050	0.050
K	0.39	0.53	0.015	0.021
L	2.54	2.54	0.100	0.100

#### NOTES

- Dimensions are exclusive of mold flash and metal burrs.
- Dimensions "J" and "L" are between centers.

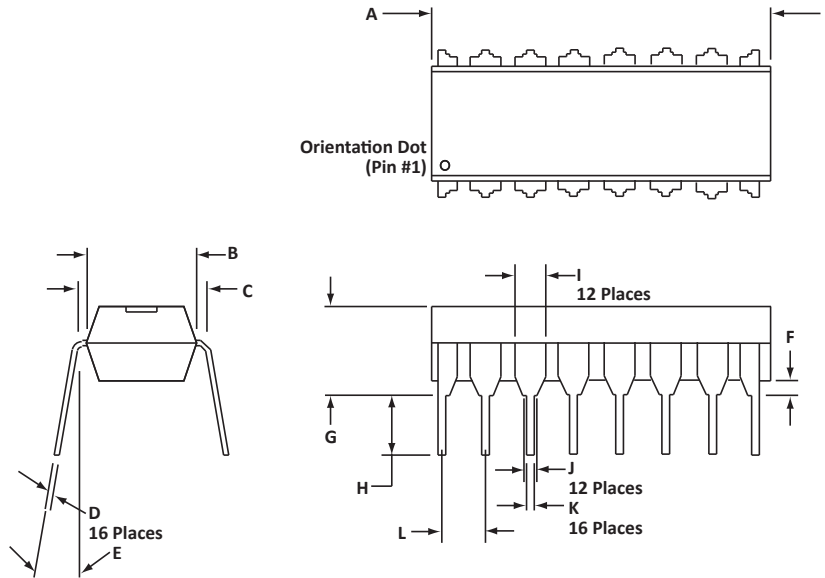

### ORDERING INFORMATION

BASE PART NUMBER (xx = Voltage)	LEADFREE SUFFIX	TAPE SUFFIX	QTY/REEL	REEL SIZE	TUBE QTY
DAxxN	-LF	n/a	n/a	n/a	25
DAxxP	-LF	n/a	n/a	n/a	25
DAxxCN	-LF	n/a	n/a	n/a	25
DAxxCP	-LF	n/a	n/a	n/a	25

#### NOTES

- Marking on Part - logo, part number, date code and pin one defined by dot on top of package.

Package outline per document number 06003.R2 9/09.

## COMPANY INFORMATION

---

### COMPANY PROFILE

ProTek Devices, based in Tempe, Arizona USA, is a manufacturer of Transient Voltage Suppression (TVS) products designed specifically for the protection of electronic systems from the effects of lightning, Electrostatic Discharge (ESD), Nuclear Electromagnetic Pulse (NEMP), inductive switching and EMI/RFI. With over 25 years of engineering and manufacturing experience, ProTek designs TVS devices that provide application specific protection solutions for all electronic equipment/systems.

ProTek Devices Analog Products Division, also manufactures analog interface, control, RF and power management products.

### CONTACT US

#### Corporate Headquarters

2929 South Fair Lane  
Tempe, Arizona 85282  
USA

#### By Telephone

General: 602-431-8101  
Sales: 602-414-5109  
Customer Service: 602-414-5114

#### By Fax

General: 602-431-2288

#### By E-mail:

Sales: [sales@protekdevices.com](mailto:sales@protekdevices.com)  
Customer Service: [service@protekdevices.com](mailto:service@protekdevices.com)  
Technical Support: [support@protekdevices.com](mailto:support@protekdevices.com)

#### Web

[www.protekdevices.com](http://www.protekdevices.com)  
[www.protekanalog.com](http://www.protekanalog.com)

COPYRIGHT © ProTek Devices 1998 - This literature is subject to all applicable copyright laws and is not for resale in any manner.

SPECIFICATIONS: ProTek reserves the right to change the electrical and or mechanical characteristics described herein without notice.

DESIGN CHANGES: ProTek reserves the right to discontinue product lines without notice and that the final judgement concerning selection and specifications is the buyer's and that in furnishing engineering and technical assistance. ProTek assumes no responsibility with respect to the selection or specifications of such products. ProTek makes no warranty, representation or guarantee regarding the suitability of its products for any particular purpose, nor does ProTek assume any liability arising out of the application or use of any product or circuit and specifically disclaims any and all liability without limitation special, consequential or incidental damages.

LIFE SUPPORT POLICY: ProTek Devices products are not authorized for use in life support systems without written consent from the factory.