

Twido and Altivar Magelis XBT-GT1100 and Preventa with Osiswitch *System User Guide*

[source code]

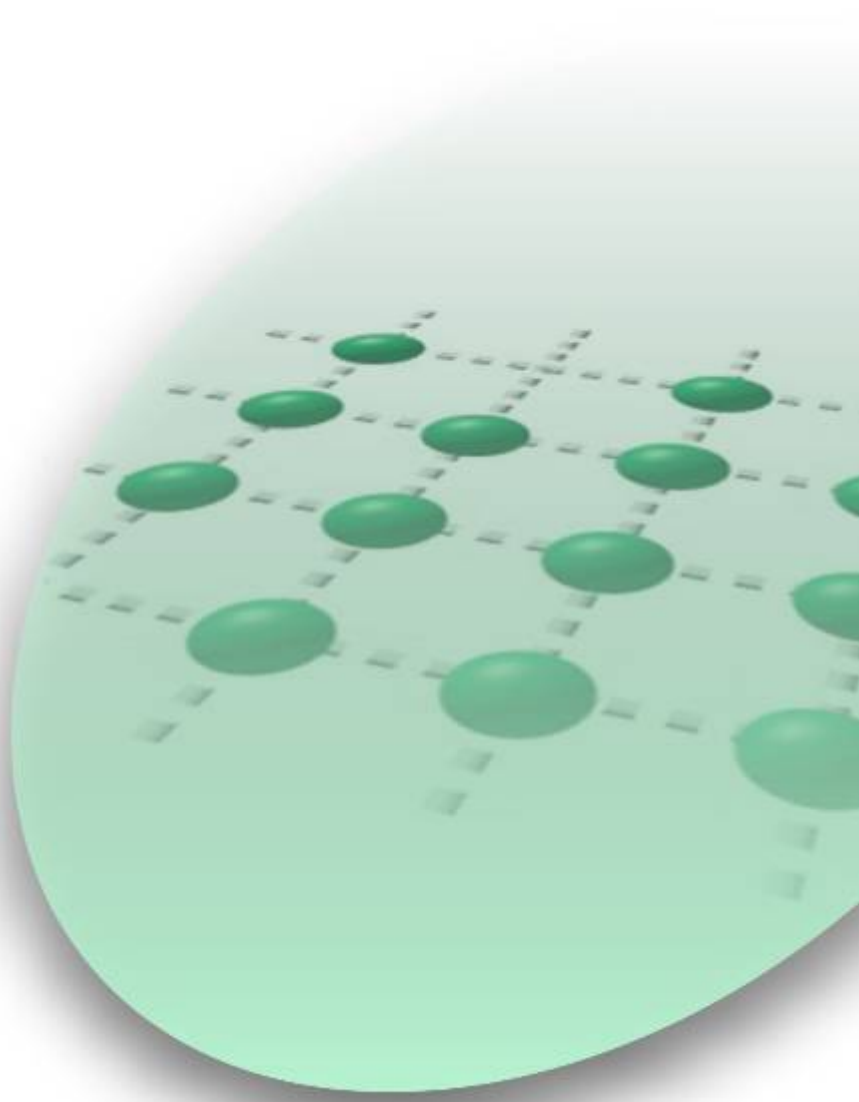
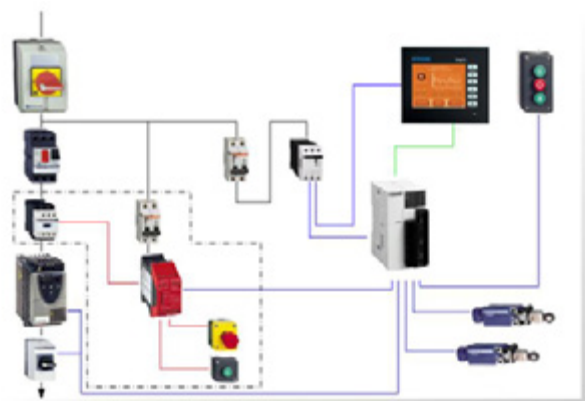

Contents

Application Source Code	3
Typical applications.....	4
System	5
Architecture.....	5
Installation.....	7
Hardware.....	9
Software	12
Communication	13
Implementation	14
HMI	15
PLC.....	32
Data exchange	34
Devices.....	35
Appendix	38
Detailed components list.....	38
Component protection classes.....	39
Characteristics of the system	40
Component Features	41
Contact	43

Introduction

This document is intended to provide a quick introduction to the described System. It is **not** intended to replace any specific product documentation. On the contrary, it offers additional information to the product documentation, for installing, configuring and starting up the system.

A detailed functional description or the specification for a specific user application is **not** part of this document. Nevertheless, the document outlines some typical applications where the system might be implemented.

Abbreviations

Word / Expression	Signification
AC	Alternating Current
Advantys	SE product name for a family of I/O modules
Altivar (ATV)	SE product name for a family of VSDs
CANopen	Name for a communications machine bus system
CB	Circuit Breaker
CoDeSys	Hardware-independent IEC 61131-3 programming software
ConneXium	SE product name for a Family of Transparent Factory devices
DC	Direct Current
EDS	Electronic Data Sheet
E-STOP	Emergency Off switch
Harmony	SE product name for a family of switches and indicators
HMI	Human Machine Interface
I/O	Input/Output
IcIA (ICLA)	SE product name for a compact drive
Lexium/Lexium05/LXM	SE product name for a family of servo-drives
Magelis	SE product name for a family of HMI-Devices
MB - SL	SE name for a serial Modbus communications protocol
Micro	SE product name for a middle range family of PLCs
NIM	SE product name for a Network Interface Module
PC	Personal Computer
Phaseo	SE product name for a family of power supplies
PLC	Programmable Logic Computer
Powersuite	An SE software product for configuring ALTIVAR drives
Premium	SE product name for a middle range family of PLCs
Preventa	SE product name for a family of safety devices
PS1131 (CoDeSys)	SE Product name for PLC programming software with CoDeSys
PS	Power Supply
SE	Schneider Electric
Sycon	SE product name of a Field bus programming software
Telefast	SE product name for a series of distributed I/O devices
Tesys U	SE product name for a de-centralised I/O System
Twido	SE product name of a middle range family of PLCs
TwidoSoft	SE product name for a PLC programming software
Unity (Pro)	SE product name for a PLC programming software
Vijeo Designer	An SE software product for programming Magelis HMI devices
VSD	Variable Speed Drive
WxHxD	Dimensions : Width, Height and Depth
XBT-L1000	An SE software product for programming Magelis HMI devices

Application Source Code

Introduction

Examples of the source code used to attain the system function as described in this document can be downloaded from our „Village“ website under [this](#) link.

The example source code is in the form of configuration, application and import files. Use the appropriate software tool to either open or import the files.

Extension	File Type	Software Tool Required
AIW	Configuration File	Advantys
CNF	Configuration File	Sycon
CO	CANopen definitions file	Sycon
CSV	Comma Separated Values, Spreadsheet	Twidosoft
CTX		Unity
DCF	Device Configuration File	Advantys
DIB	Device Independent Bitmap	Sycon
DOC	Document file	Microsoft Word
DOP	Project File	Magelis XBTL
EDS	Electronic Data Sheet – Device Definition	Industrial standard
FEF	Export file	PL7
GSD	EDS file (Geraete Stamm Datei)	Profibus
ISL	Island file, project file	Advantys
PB	Profibus definitions file	Sycon
PDF	Portable Document Format - document	Adobe Acrobat
PS2	Export file	Powersuite export file
RTF	Rich Text File - document	Microsoft Word
STU	Project file	Unity studio
STX	Project file	PL7
TLX	Project file	Twinline control tool
TWD	Project file	TwidoSoft
VDZ	Project file	Vijeo Designer
XEF	Export file	Unity Pro
ZM2	Project File	Zeliosoft

Typical applications

Introduction



Here you will find a list of the typical applications, and their market segments, where this system or subsystem can be applied:

Industry

- Small automated machine or plant components.
- Remote automation systems used to supplement large and medium-sized machines.

Buildings/Services

- Goods elevators, e.g., for use in cafeterias or hospitals.
- Climate management in greenhouses.

Application	Description	Image
Freight or goods elevators	This application is used in the implementation of goods elevators, which are for example, used in canteens and hospitals.	
Greenhouses	This application is used to open/close greenhouse windows and shutters to regulate the climate in the greenhouse.	

System

Introduction

The system chapter describes the architecture, the dimensions, the quantities and different types of components used within this system.

Architecture

General

The control section of this application consists of a PLC, which can be controlled via push buttons or a Magelis panel. The load section is implemented using an Altivar VSD, which also controls changes of direction, and an additional lockable maintenance switch, which is located between the drive and the motor.

In this case, an emergency stop switch is used to initiate shut down and ensure the (optional) safety. The emergency stop switch activates a Preventa analyzing unit and, in the event of an emergency, shuts down the redundant conductors before the drive (safety category 3).

The system also has two limit switches, which limit the motor's path of travel.

An additional sensor, which can be used to implement approximate position control via the pulse rate, can be included as an option.

Layout

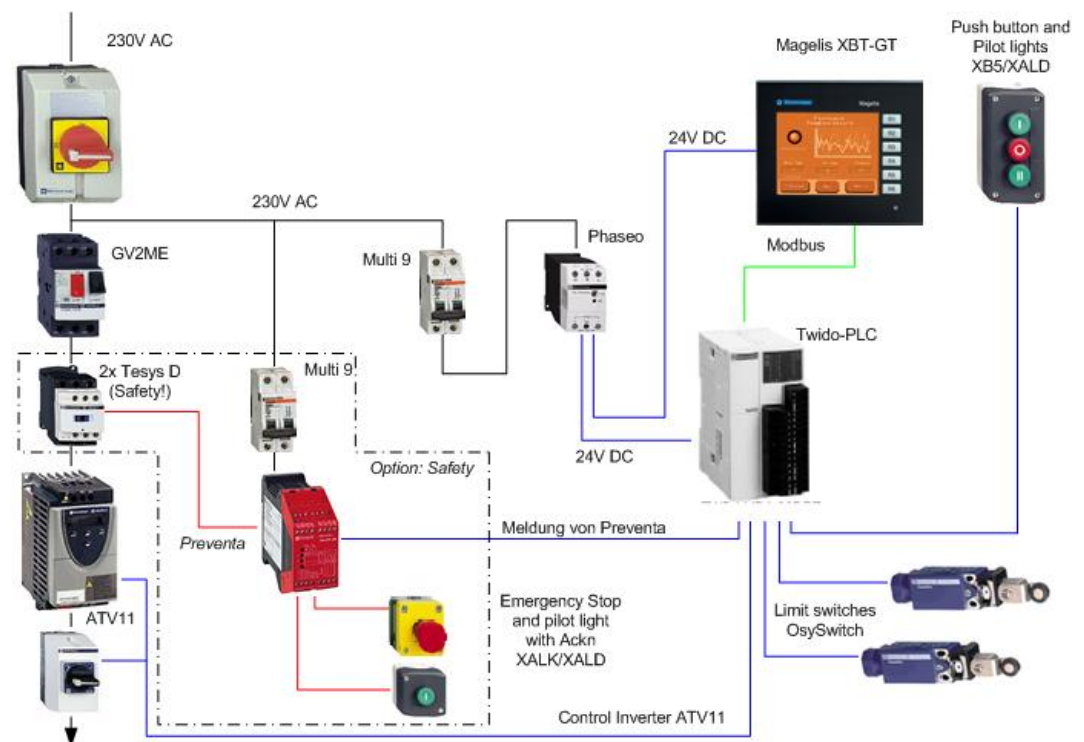

Components**Hardware:**

- Vario VCD master switch (with red and yellow knob)
- Vario VBF master switch (as maintenance switch with black knob)
- GV2ME motor circuit breaker
- Altivar ATV11 variable speed drive
- XALK locking-type emergency stop switch with rotary unlocking (tamper-proof)
- Phaseo ABL7 power supply unit
- TWIDO modular PLC
- Magelis XBT GT1100 operator terminal
- XB5 selector switches, push buttons and indicator lamps, from the Harmony Style 5 range
- XCK OsySwitch roller limit switches
- Standard AC motor

Software:

- Twidosoft 3.2
 - PowerSuite 1.5 (option)
 - Vijeo-Designer 4.3.0
-

Quantities of components

Only one unit is needed per system component to fulfill the requirements of the specified task (with the exception of roller limit switches, contactors and buttons/indicator lamps).
A detailed list of the required components, including quantities and part numbers, can be found in the Appendix to this document.

Degree of Protection

Not all of the components used within this configuration have been designed to withstand the full range of environmental conditions in the field. These components will, therefore, require additional protection and are only suitable for installation in a control cabinet. For information about which components are suitable for direct installation on site, please refer to the list provided in the Appendix (column headed "In the field, on site", which also indicates the relevant IP protection class).

Technical data

Supply voltage	230 V AC
Total supply output	~ 3.5 kW
Motor output	≤ 0.75 kW
Motor brake	No
Connector cross-section	3x 2.5mm ² (L, N, PE)
Safety category	Cat. 3 (optional)

Safety notice

In this application example, Category 3 (according to EN 954-1) has been selected for the purpose of ensuring safety. The issue of whether a safety category (1-4) is to be adopted and, if so, which one, will be determined by the system's design and the overall extent to which this system represents a hazard to people and machinery. Safety category 3, based on EN 954-1, is the second highest category there is.

Size/Dimensions

The compact dimensions of the devices used, e.g., the PLC and PS, mean that the components can be installed in a small control cabinet with the following external dimensions: 350 x 350 x 210 mm (WxHxD).
Furthermore, the display elements used to indicate a "group error" and "no protection" can be built into the door of the control cabinet along with the system master switch and emergency stop master switch.

Installation

Introduction

This chapter describes the steps necessary to set up the hardware and configure the software required to fulfil the described function of the application.

Assembly

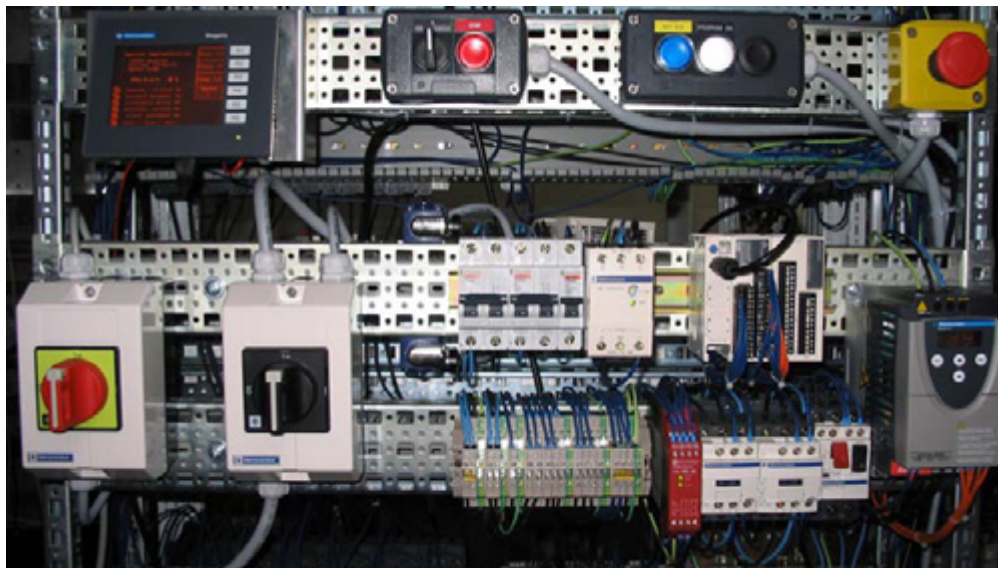

Notes

This application was configured to control the amount of light and climate control in a greenhouse.

The components and I/O points listed below represent a cross-section of the components and signals that are the essential minimum for control and display purposes and a select number of optional inputs and outputs which can be used in conjunction with most typical applications (safety/maintenance switches).

This document does not claim to be comprehensive and **does not absolve users** of their duty to check the safety requirements of their equipment and to ensure compliance with the relevant national or international rules and regulations in this respect.

Safety category 3, which is suggested here as one possible option, is not necessarily required or adequate for every application. A risk analysis normally defines the safety category to be used. A risk analysis, in accordance with the national and/or international standards and regulations in force, must be drawn up and verified for each individual system.

PLC wiring

Twido PLC inputs	Description
DC In 0	Not used, reserved for high-speed counters
DC In 1	Not used, reserved for high-speed counters
DC In 2	Open selector switch
DC In 3	Close selector switch
DC In 4	Stop button
DC In 5	Limit switch open
DC In 6	Limit switch closed
DC In 7	Motor circuit breaker OK
DC In 8	Variable speed drive OK (RC terminal)
DC In 9	Maintenance switch OK (option)
DC In 10	Safety present (option)
DC In 11	Spare

Twido PLC outputs	Description
Trans. Out Q0	PLC ON (24 V)
Trans. Out Q1	Group fault (24 V)
Relay Out Q2	Input LI1 ATV11 (clockwise rotation, close)
Relay Out Q3	Input LI2 ATV11 (counterclockwise rotation, open)
Relay Out Q4	Input LI3 ATV11 (select bit 0, JOG frequency)
Relay Out Q5	Spare (24 V)
Relay Out Q6	Spare (24 V)
Relay Out Q7	Input LI3 ATV11 (select bit 1, JOG frequency)

Twido 24 V supply	Description
Com (inputs)	0 V DC reference voltage
-V	0 V DC reference voltage
Com (+)	+24 V DC
Com 1	+15 V DC (ATV11 potential)
Com 2	+24 V DC
Com 3	+15 V DC (ATV11 potential)

VSD control circuit wiring





ATV11	Description
LI1	Twido relay Out Q2
LI2	Twido relay Out Q3
LI3	Twido relay Out Q4
LI4	Twido relay Out Q7
RA	+24 V DC
RC	Twido In 8
+15 V	Twido Com 1 and Com 3

Hardware

General

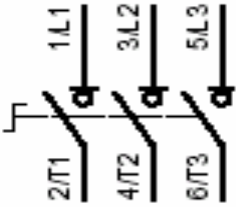

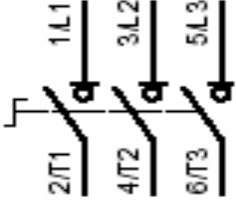

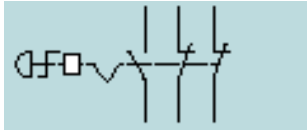

- The components designed for installation in a control cabinet, i.e., Twido PLC, Phaseo power supply unit, emergency stop switching device, line circuit breaker, contactors and motor circuit breaker, can be snapped onto a 35 mm top-hat rail.
- The Altivar variable speed drive can also be installed in a control cabinet, but requires an adapter bracket.
- Emergency stop, master and maintenance switches are designed for backplane assembly in the field; all switches can also be installed directly in a control cabinet (e.g., on control cabinet door) without their enclosing housings.
- There are two options available for mounting XB5 push buttons and indicator lamps:
 1. option: Using a 22 mm hole drilled into the front door of the control cabinet in the appropriate position.
 2. option: Using an XALD housing, which can house up to 5 push buttons or indicator lamps. This XALD is designed for backplane assembly or direct wall mounting.
- 230 V AC wiring between mains switch, emergency stop switch and relay, 24 V supply (primary), as well as motor circuit breaker, load relay and VSD.
- 24 V DC wiring between power supply unit, PLC, push buttons, indicator lamps and VSD control circuit.
- Drive wiring via relay contacts with potential voltage from the drive (neither 24 V DC nor 230/400 V AC).

Components

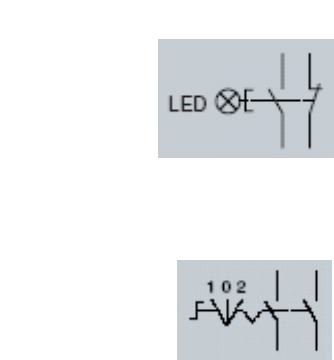
<p>Mains switch</p> <p>VCF-02GE</p> <p>(red/yellow switch)</p>		
<p>Maintenance switch</p> <p>VBF-02GE</p> <p>(black switch)</p>		
<p>EMERGENCY STOP switch</p> <p>XALK178G</p>		

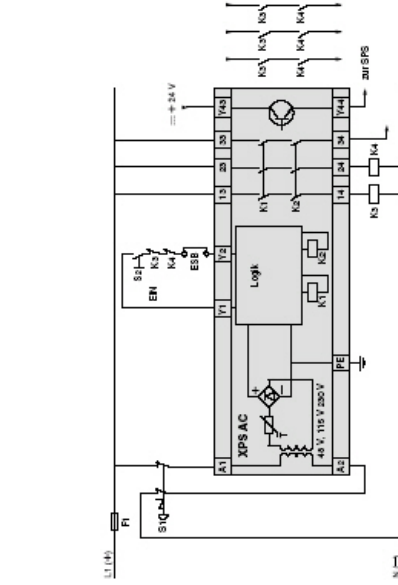

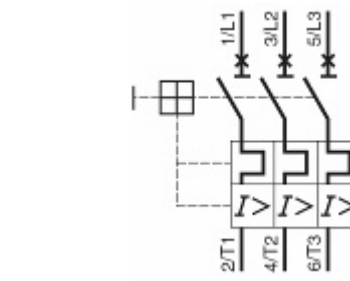

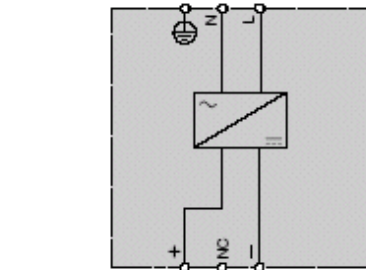

Continued on next page

Components
Contd.

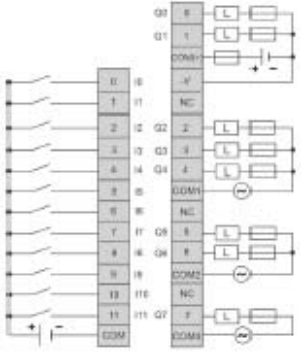
<p>Harmony Style 5 selector and push button switch with indicator lamp</p> <p>XB5</p>		
<p>EMERGENCY STOP fault relay</p> <p>XPS AC3721</p>		
<p>Motor circuit breaker</p> <p>Circuit breaker GV2-ME16</p>		
<p>Phaseo power supply unit</p> <p>ABL7CEM24012</p>		

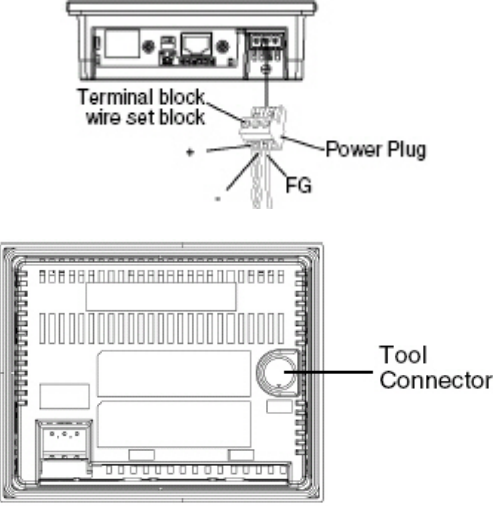
Continued on next page

Components
Contd.

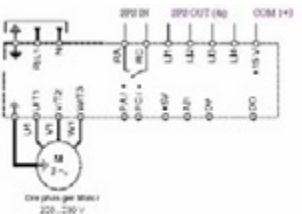
<p>Twido PLC TWDLMDA 20DRT</p>	 <p>TWD LMDA 20DRT</p>	
<p>Magelis operator terminal 3,8" XBT-GT1100</p>		 <p>Terminal block wire set block</p> <p>Power Plug</p> <p>FG</p> <p>Tool Connector</p> <p>(rear view)</p>
<p>Osiris roller limit switch XCD2118P16</p>		
<p>Altivar ATV11 variable speed drive ATV11PU18M2E</p>		 <p>One phase per Motor 220-230 V</p>

Software

General

Software is primarily used for programming the Twido, including creating the configuration for communication and assigning inputs and outputs. The **Twidosoft** programming tool is used for programming.

The HMI application on the Magelis operator terminal is configured using **Vijeo-Designer** software.

The Altivar 11 variable speed drive can be parameterized using the front operator panel. However, the **PowerSuite** software is a more user-friendly option and can be used for configuring the drive, saving data and quickly restoring existing data/configurations for maintenance purposes.

Powersuite can be used to optimize the parameters online.

To use the software packages, your PC must have the appropriate Microsoft Windows operating system installed:

- Windows 2000 *or*
- Windows XP

The software tools have the following default install paths:

- Twidosoft *C:\Program Files\Schneider Electric\TwidoSoft*
- Vijeo-Designer *C:\Program Files\Schneider Electric\Vijeo-Designer*
- PowerSuite *C:\Program Files\Schneider Electric\PowerSuite*



Twidosoft 3.2

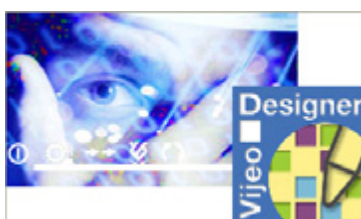

Vijeo-Designer 4.3.0



Powersuite V1.5

Communication

General

A Modbus connection is used to exchange data between the Magelis XBT GT1100 terminal and the Twido PLC. The XBTZ9780 communication cable shown below is needed to connect these two devices. The software driver required for Modbus communication is already contained in the software packages for the Magelis panel and the Twido.

Magelis

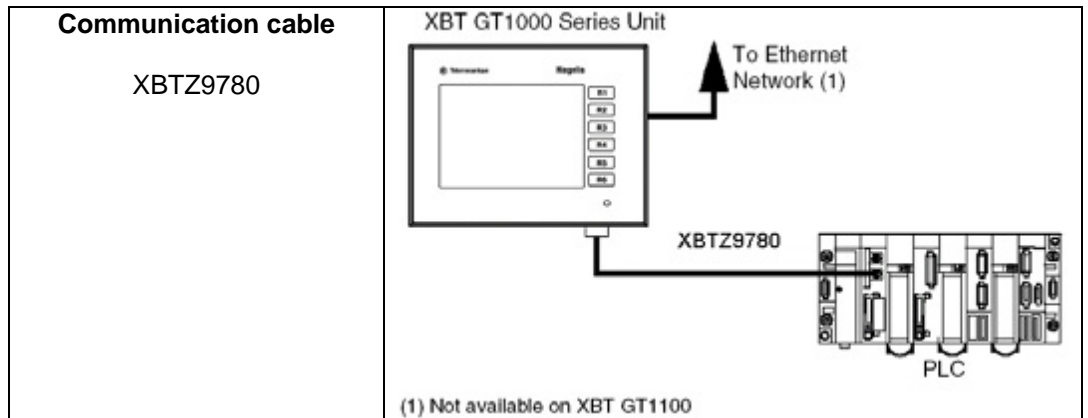

Implementation

Introduction

The implementation chapter describes all the steps necessary to initialise, to configure, to program and start-up the system to achieve the application functions as listed below.

Function

Functional description

1. All the conditions required to clear the group error lamp must be met, i.e., motor circuit breaker and maintenance switch switched on and safety circuit on. The group error message disappears and the Magelis panel is visible on the main screen.
2. The motor can only be controlled in the “open”/”close” direction if the associated limit switch has not been pressed and no errors are pending.
3. Push buttons: The selection for opening and closing can be activated via the selector switch. Invoking the motion function starts motion in the selected direction. Motion can be stopped by pressing the stop button, selecting the opposite direction or reaching the limit switch. It will also stop if an error occurs. Although operation is always possible via the push button housing, when this function is used, motion is always made at the lowest speed (1).
4. Motion can also be activated by entering a “1” in the “open” or “close” parameter, as appropriate. Motion control via the Magelis panel is ignored if the push button housing selector switch is not in the centre position (priority circuit). Entering “0” in the parameter stops the drive, just as if the hardware stop button had been pressed.
5. Speed pre-selection: The speed for the variable speed drive can be pre-defined via the Magelis terminal. A number from 0 to 3 can be entered (0 = lowest speed). The default setting is 0 and will also return to default when an error occurs.
6. Faults: Faults are displayed as group errors via a fault indicator lamp or as individual fault messages on the Magelis panel.

Layout

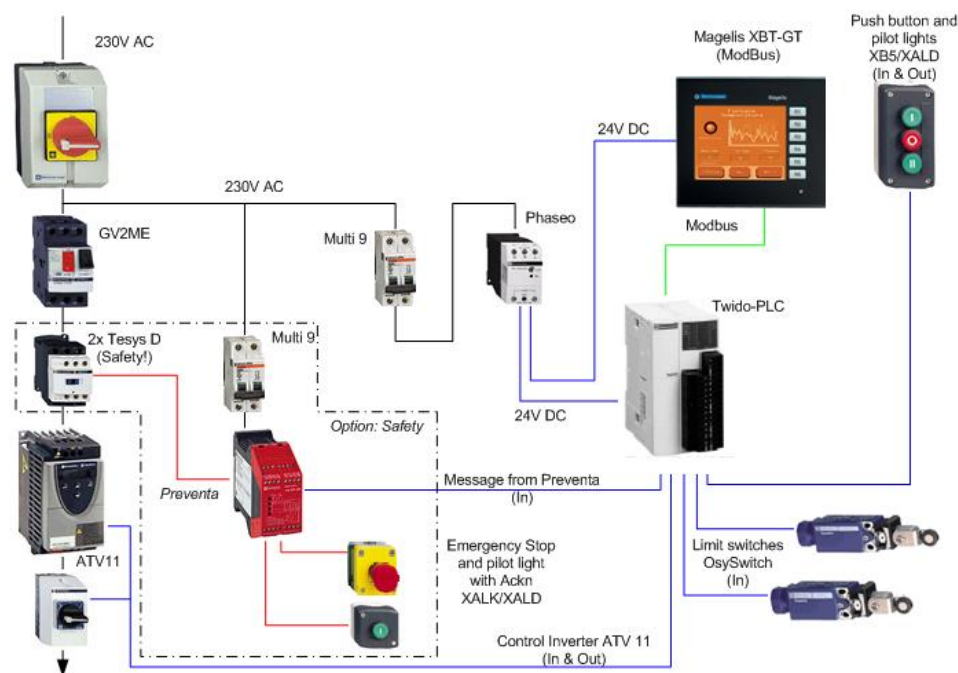

HMI



Introduction

This application features a Magelis XBT GT1100 HMI, which is interfaced with the PLC via the Modbus protocol. To configure the Magelis, Vijeo-Designer software is used. The procedure is explained in the following pages.

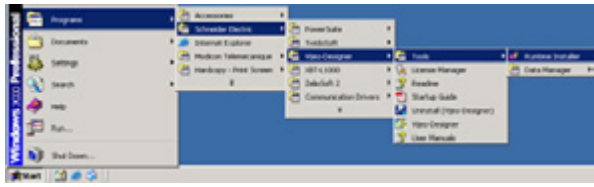
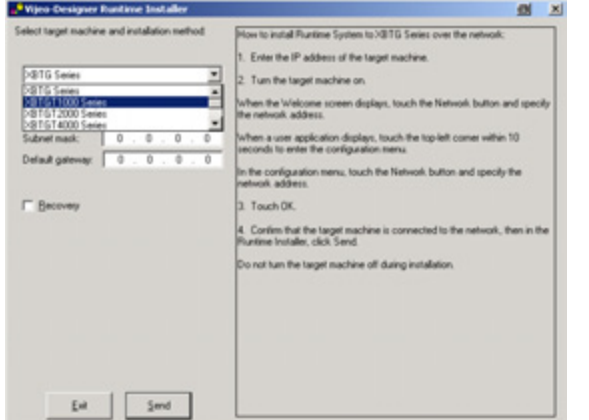
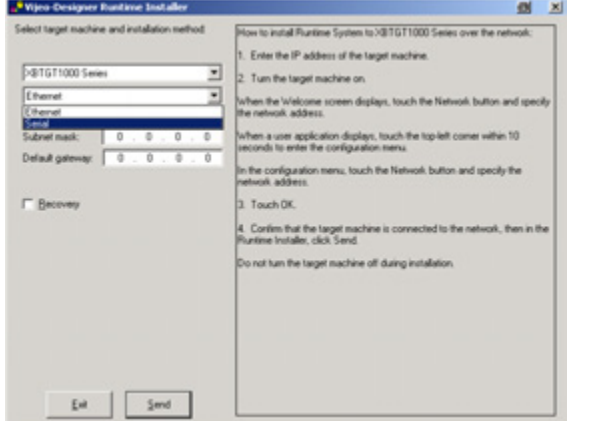
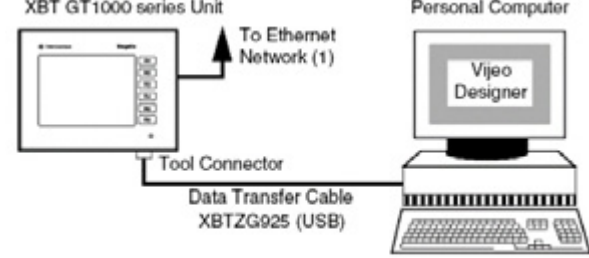
Updating Runtime

<p>1</p>	<p>Depending on the firmware that is delivered within the XBT GT, the runtime of the device might be updated to the version 4.3. To do this, start the Runtime Installer which can be invoked by:</p> <ul style="list-style-type: none"> - Start - Programs - Schneider Electric - Vijeo-Designer - Runtime Installer 	
<p>2</p>	<p>The destination device must be inserted in the top box.</p> <p>Please select the XBTGT1000 Series entry.</p>	
<p>3</p>	<p>The XBT GT1100 does not provide an Ethernet port, so you must select Serial.</p>	
<p>4</p>	<p>Now you need to connect the PC and the operator panel by using the cable XBTZG925.</p>	 <p>(1) Not available on XBT GT1100</p>

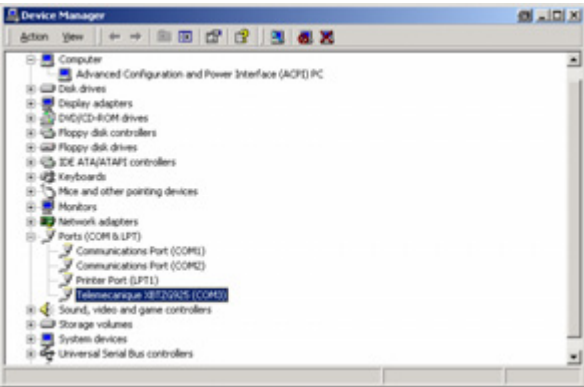
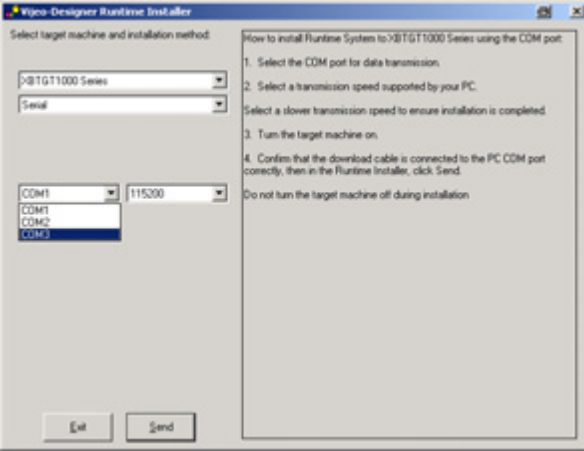
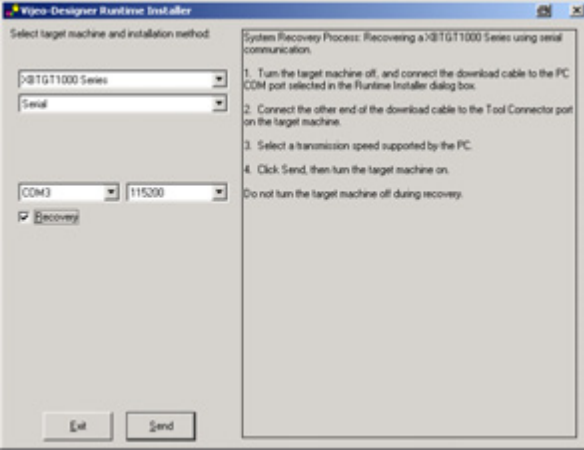
Updating Runtime
Contd.

<p>5</p>	<p>Windows assigns the USB cable to a specific port - in this case it is mapped to COM3. To check what port it has been mapped to, view the settings by clicking</p> <ul style="list-style-type: none"> - Start - Control panel - System - Hardware [Tab] - Device Manager - Ports (COM & LPT) [Folder] 	
<p>6</p>	<p>Back to the configuration screen for the runtime installer you select the COM port assigned to the USB cable. In this example it is COM3.</p> <p>The setting for the baud rate remains at 115200.</p>	
<p>7</p>	<p>Check the Recovery option for downloading the runtime. Now follow the steps below:</p> <ol style="list-style-type: none"> 1. Turn off the power supply for the device. 2. Click Send at the bottom of the dialog 3. Turn on the power supply for the device. 4. Do not break the connection between Magelis panel and PC and do not turn off the power supply while the transfer is active 	
<p>8</p>	<p>When the transfer has been successfully finished you will have to acknowledge the message with OK.</p> <p>Please note that no application has been transferred to the HMI device yet.</p> <p>A runtime download normally only needs to be done once.</p>	

**Programming/
Configuration**

<p>1</p>	<p>Vijeo Designer has the following components:</p> <ul style="list-style-type: none"> 1 - Navigator 2 - Info-Display 3 - Inspector 4 - Data list 5 - Feedback Zone 6 - Toolbox 	
<p>2</p>	<p>After starting Vijeo Designer, select Create New Project and press Next.</p>	
<p>3</p>	<p>Input a Project Name e.g. "Example" and select: Project with Single Target Press Next.</p>	

**Programming/
Configuration**
Contd.

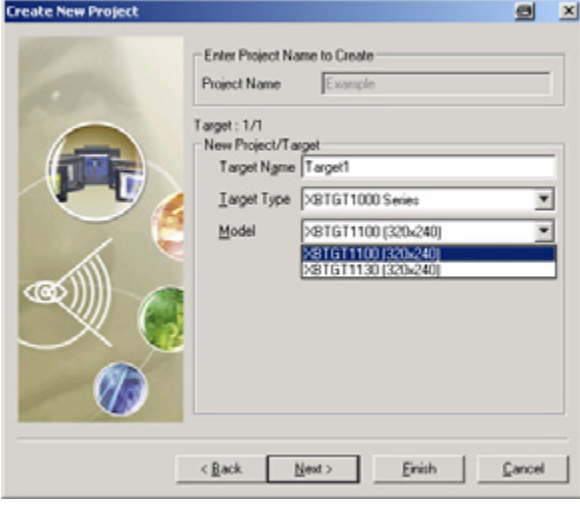
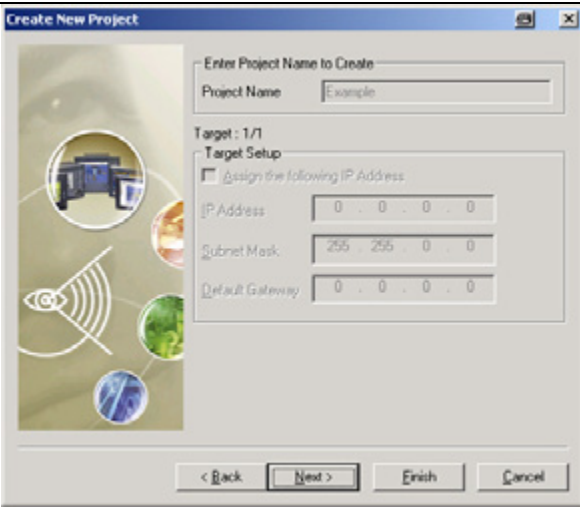
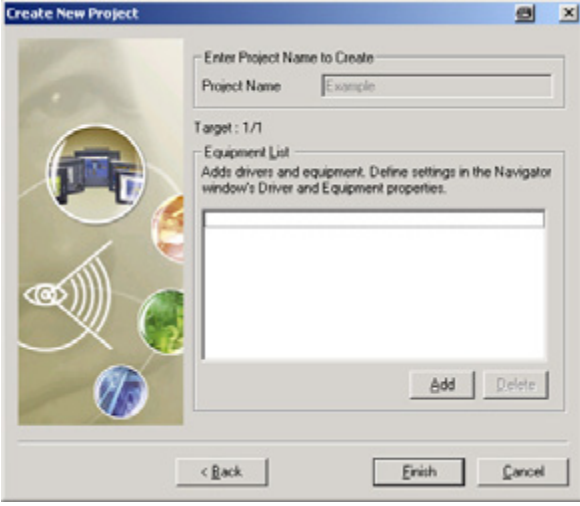
<p>4</p>	<p>Select the target device</p> <p>Target Name: "Target1"</p> <p>Target Type: "XBTGT 1000 Series"</p> <p>XBTG Model: "XBTGT1100"</p>	
<p>5</p>	<p>The device has no Ethernet interface, so it requires no IP address.</p> <p>Here simply press Next and go to the next dialog.</p>	
<p>6</p>	<p>The Magelis needs the correct type of driver to exchange data with the PLC.</p> <p>Use Add to go to the driver selection dialog and select a new driver.</p>	

**Programming/
Configuration**
Contd.

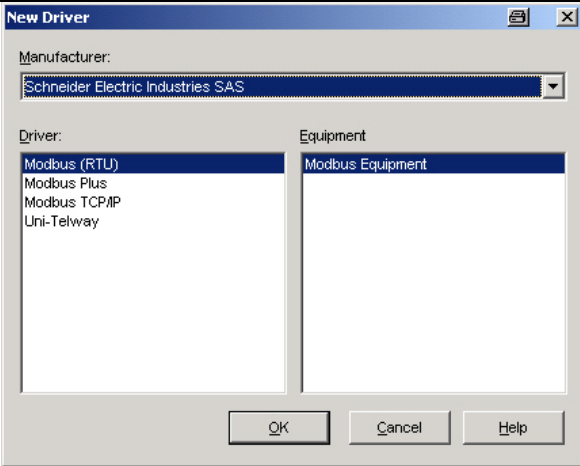
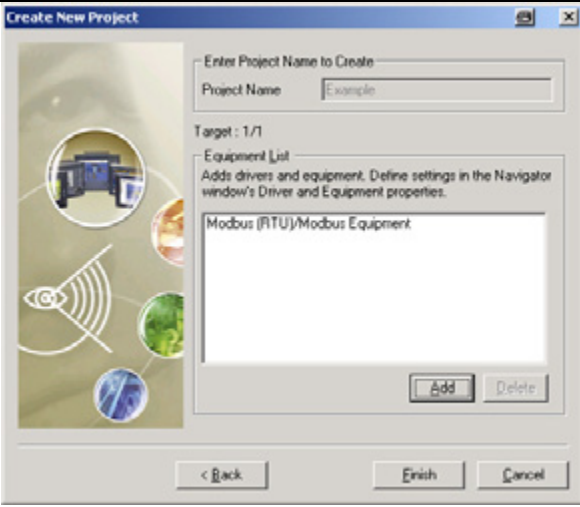
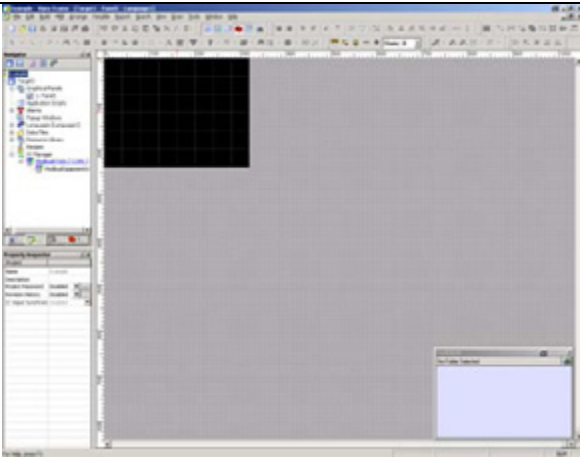
<p>7</p>	<p>In the New Driver dialog</p> <p>Select:</p> <p>Manufacturer: “Schneider Electric Industries SAS”</p> <p>Driver: “Modbus(RTU)”</p> <p>Equipment: „Modbus Device”</p> <p>confirm with OK.</p>	
<p>8</p>	<p>After setting up the driver you can exit the dialog with Finish.</p>	
<p>9</p>	<p>Vijeo-Designer now returns you to its work top, with an empty display and the project navigator</p> <p>A mouseclick on Target1 in the navigator brings up the properties inspector</p> <p>(or if the properties inspector is closed right mouseclick on Target1 and selecting Properties opens up the properties inspector)</p>	

**Programming/
Configuration**
Contd.

10 Check the properties of the project and in particular the properties of the **COM-port**. It must be set to **serial** for the connection to work properly.

Ensure that the COM port settings are correct.

In this example the USB cable has been assigned to port COM 3. In doubt please check the hardware settings of your systems according step 5 of the runtime installer description.

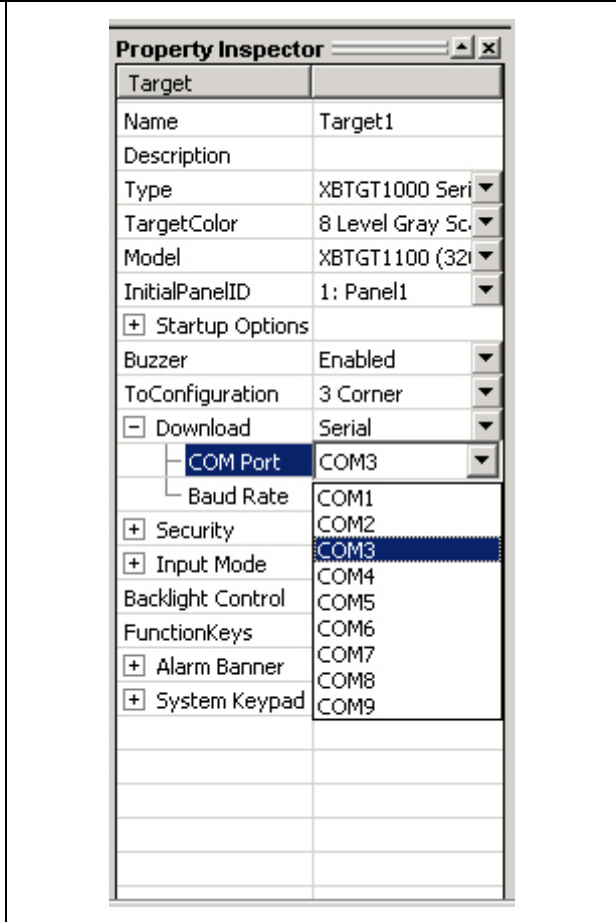

11 Although downloading to the Magelis will not actually be performed now, you must connect the **COM** port of the PC with the **Tool** port on the Magelis to perform the download.

Use the USB cable **XBTZG925** to make the connection.

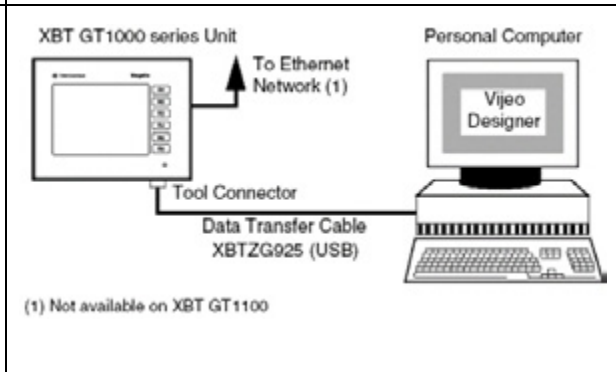

**Communication
Setup**

12 In the Navigator, with a right mouseclick on the name, you can **Rename** the configuration to „TWIDO“.

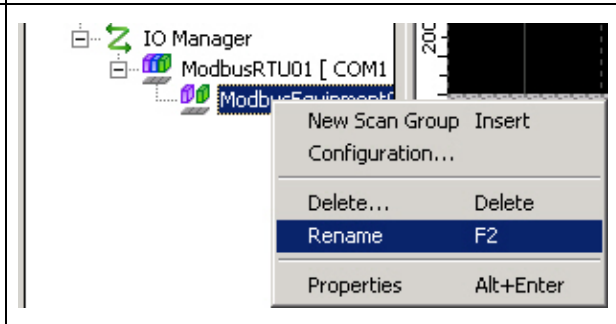

**Programming/
Configuration**
Contd.

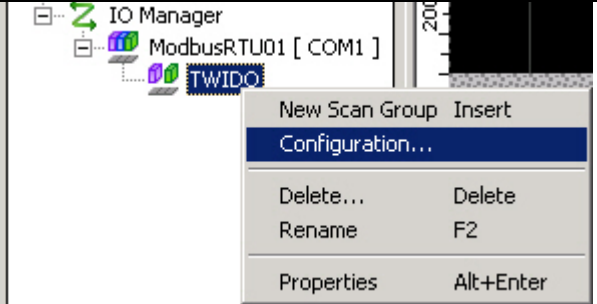
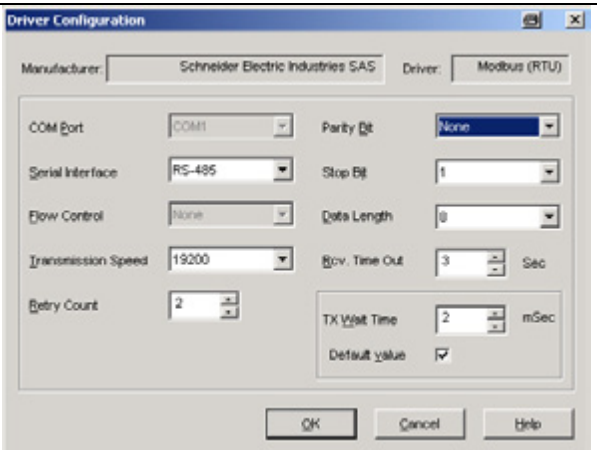
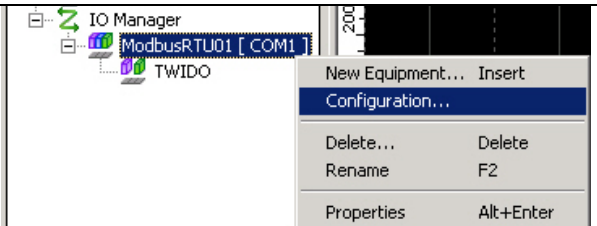
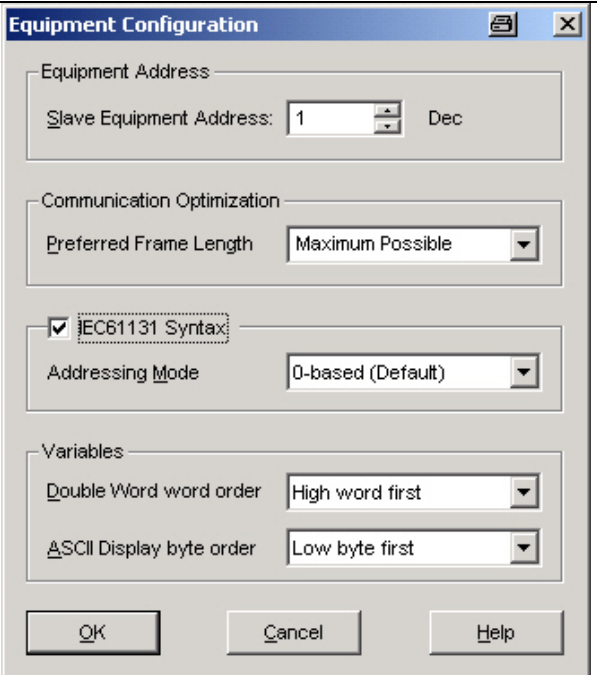
<p>13</p>	<p>To edit the configuration, right mouseclick on TWIDO in the navigator and select:</p> <p>configuration.</p>	
<p>14</p>	<p>In the Driver Configuration dialog, input:</p> <ul style="list-style-type: none"> - RS-485 - 19200 Baud - 8 Data bits - 1 Stop bit - No Parity - 2 Retry Counts <p>Exit the dialog with OK.</p> <p>The configuration must match the port definition on the Twido.</p>	
<p>15</p>	<p>For the communications to work you must set up the parameters in the Modbus RTU-Driver</p> <p>For this, right mouseclick on ModbusRTU01 in the Navigator and select Configuration...</p>	
<p>16</p>	<p>In this screen retain all the default settings. Click and set the checkbox for IEC61131 Syntax.</p> <p><i>Following the IEC 61131 syntax addressing with Twido is easier.</i></p>	

**Programming/
Configuration**
Contd.

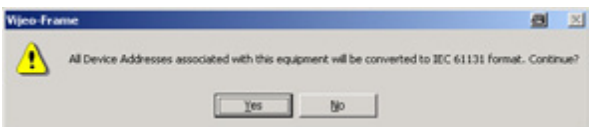
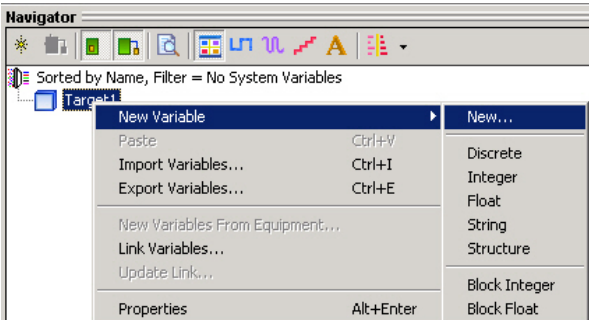
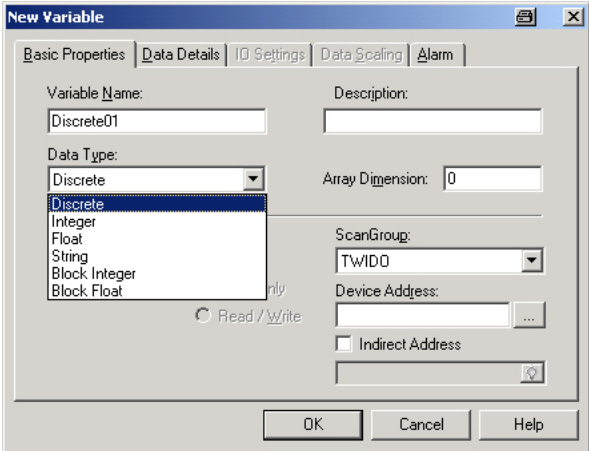
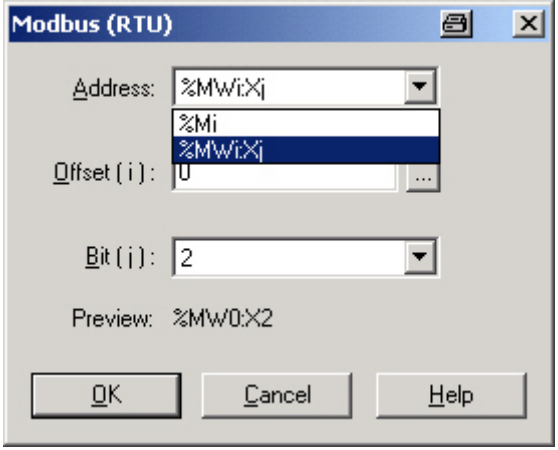
17	<p>After setting the checkbox you have to confirm the action with Yes.</p>	
18	<p>To create variables, first click on the Tab variable in the navigator.</p> <p>A right mouse click on Target1 in the navigator opens up the pop-up menu to go to New Variable -> New... and the variable definition dialog.</p>	
19	<p>To create a variable you must input a:</p> <ul style="list-style-type: none"> • Variable name • Data type • Data Source (External) • Device (Scan Group) • Address in the PLC <p>Here you can address</p> <ul style="list-style-type: none"> • bits (%M.. & %MW...:X..) • memory words (%MW..) <p>in the PLC.</p> <p>PLC internal formats such as counters must first be transferred to memory words before the Magelis can display them.</p>	
20	<p>Integers and Reals :</p> <p style="padding-left: 40px;">%MW** (e.g. MW 2)</p> <p>Discretes:</p> <p style="padding-left: 40px;">%M** (e.g. %M2)</p> <p style="padding-left: 40px;">%MW** :X** (e.g. %MW2:X5)</p> <p>where „X**“ represents the bit number or word number i.e. address them with the appropriate offset.</p>	

**Programming/
Configuration**
Contd.

21 In the example code - with the exception of Remote_speed - only Discretes are used for the communication.

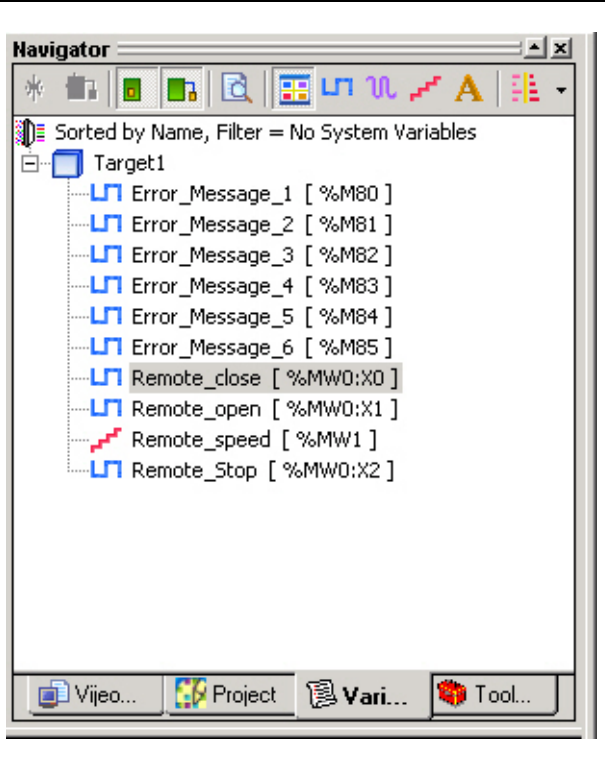

**Configuration
Function keys**
(R1..R6)

1 For configuring/programming the R1..R6 function keys on the right hand side of the panel there are three possibilities:

- **general** function keys (action does not **depend** on the actual screen)
- **screen orientated** function keys (action **depends** on the actual screen)
- **mixed function** keys (general and screen oriented keys within one action)

In this example only general function keys are used.

To define general function keys the select **FunctionKeys** in the property inspector and click on [...].

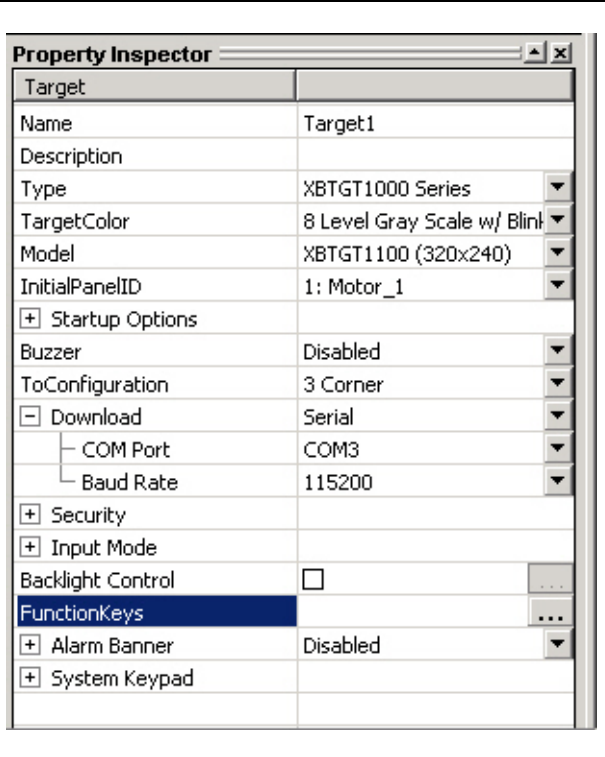

Configuration Function keys (R1..R6)
Contd.

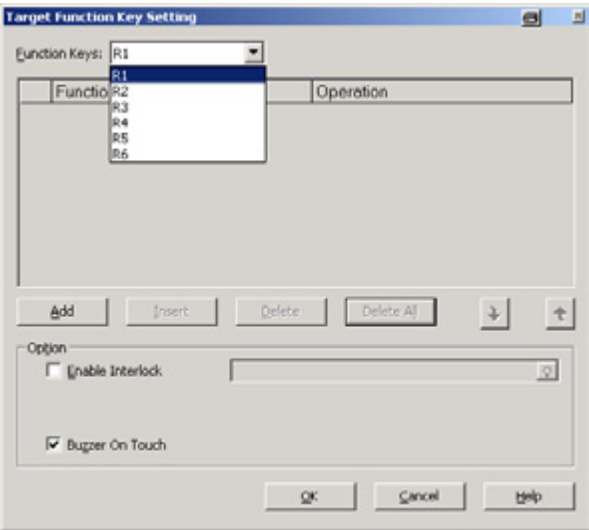
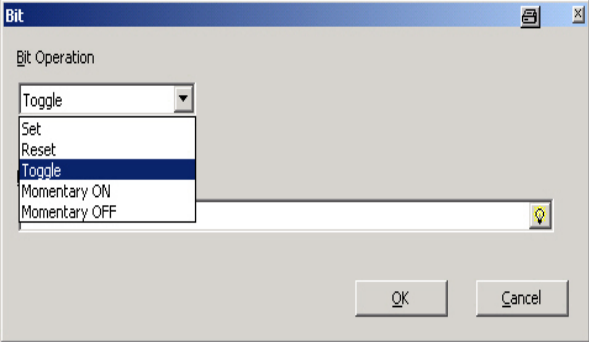
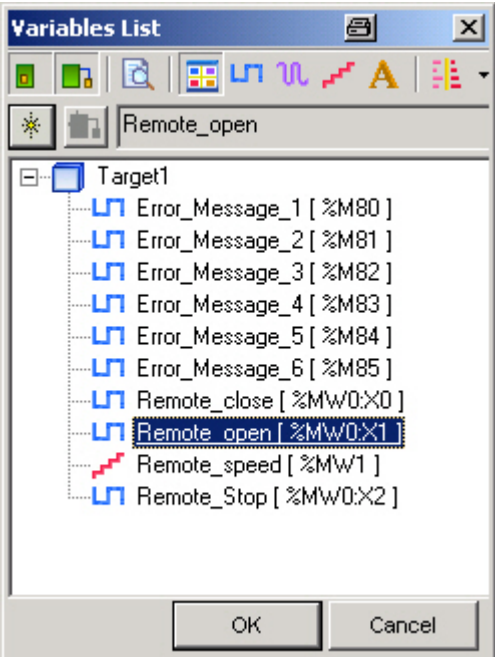
<p>2</p>	<p>At the top of the screen you can select the function key you would like to configure, for instance R1.</p> <p>Click on the Add button to create a new action that will be invoked when you press this function key.</p>	
<p>3</p>	<p>In the following screen you can decide in which way the variable should be influenced. In this example the action is a toggle.</p> <p>To select the affected variable, click on the lightbulb icon on the right hand side of the edit box.</p>	
<p>4</p>	<p>A list of the available variables is now opened.</p> <p>Select one with a double click or by marking it and clicking OK.</p> <p>On clicking OK, you return immediately to the previous screen.</p> <p>To confirm the action you have to click again on OK.</p>	

Configuration Function keys
(R1..R6)
Contd.

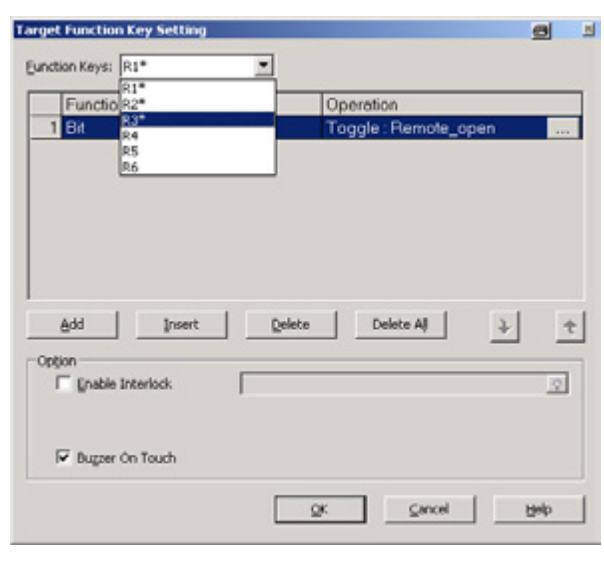
5	<p>Already configured function keys are indicated with an asterisk, for example R3*</p>	
---	--	--

Example Insert text

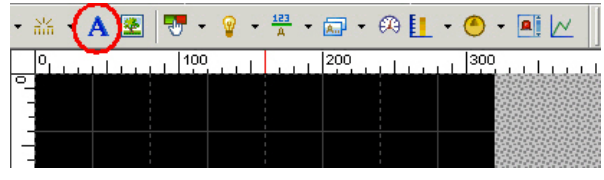
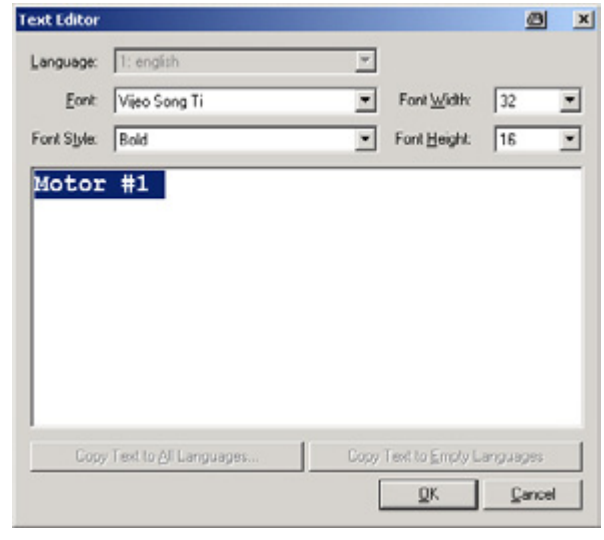
1	<p>Example: Insert Text</p> <p>Select the text icon in the tool bar.</p> <p>The toolbar displays the toolbox with tools for editing the display.</p>	
2	<p>Example: Create Text</p> <p>With the text tool you can position the text box on the display. You can adjust its size by „pulling“ on the box or by inserting the width and height in the text editor dialog.</p> <p>To got to the text editor dialog, double click on the text box. In the text editor dialog, you can input the actual text to be displayed and define its size, font, etc.</p>	

**Example
Insert text**
Contd.

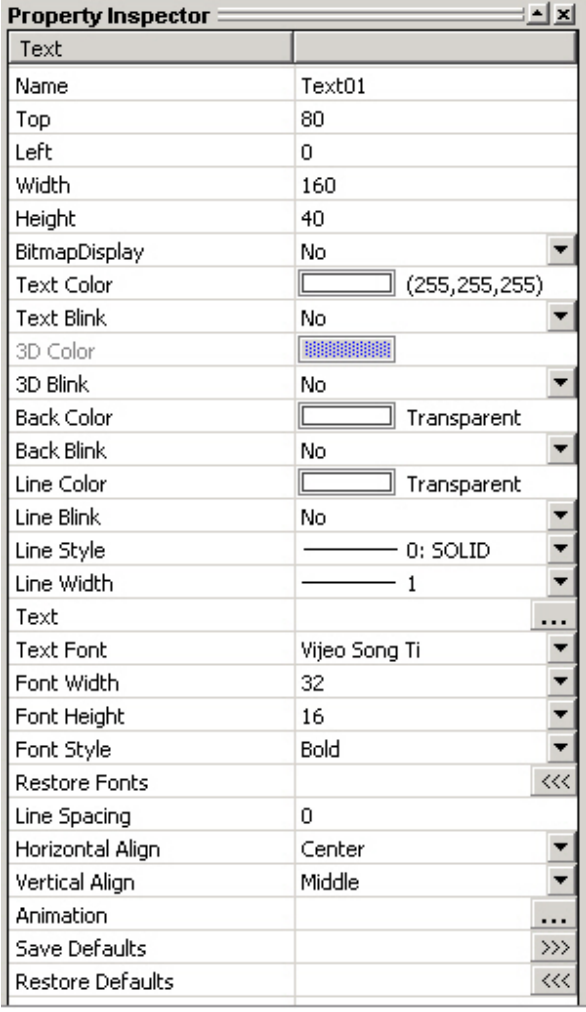
<p>3</p>	<p>After inputting the text you can define/change the text characteristics in the Property Inspector</p>	
-----------------	---	---

**Example
Insert lamp**

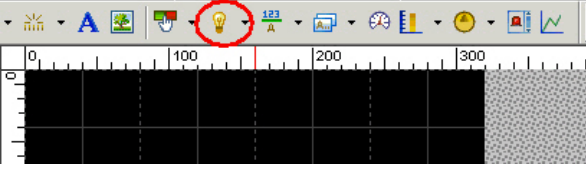
<p>4</p>	<p>Example: Insert Lamp</p> <p>Select the lamp tool in the tool bar.</p> <p>With this tool, position the lamp on the display. You can adjust its size by „pulling“ the sides.</p>	
-----------------	--	--

**Example
Insert lamp**
continued

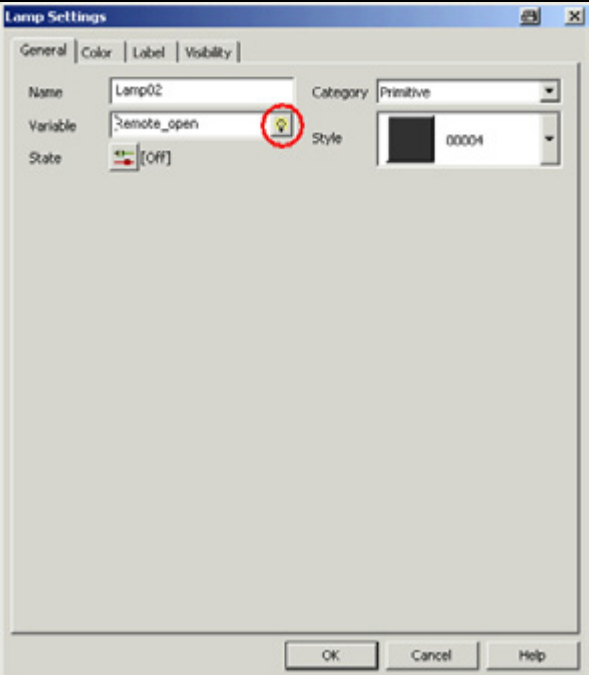
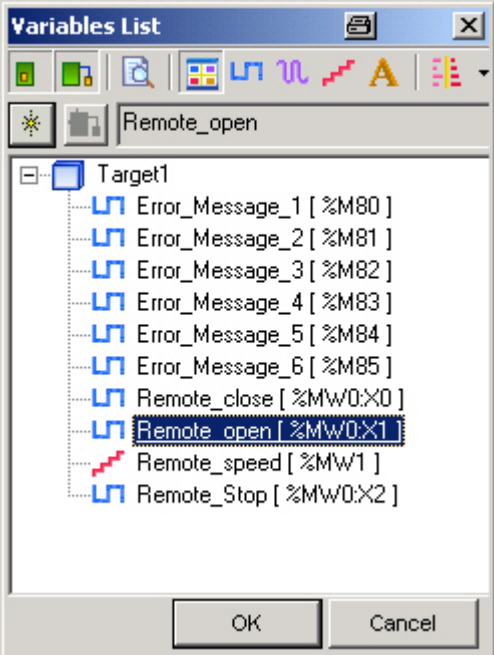
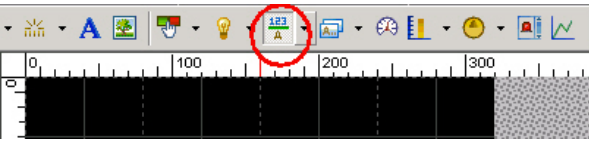
<p>5</p>	<p>A right mouse click on the lamp object in the display invokes the Lamp Settings dialog.</p> <p>To assign a variable to the lamp click on the light bulb.</p>	
<p>6</p>	<p>A list of existing variables will be displayed. Select the variable you need to animate your lamp by double clicking on the specific variable or by marking it and finally confirming the action with OK.</p>	
<p>7</p>	<p>Example: Insert numerical display</p> <p>Select the numerical display tool in the tool bar.</p> <p>With this tool, position the field on the display. You can adjust the size of the field by „pulling“ on the sides/corners.</p>	

**Example
Numerical
Display**

Example Numerical display
Contd.

8 If for the numerical displays you can define:

- style of the display
- data type (integer/float)
- zero suppress
- number of display digits
- display/not display zero
- Format e.g. hex., dec.
- font style
- font size
- text alignment

For the variable used to animate the object shown, you can either manually input the variable name or click on the lightbulb icon to browse the variable list and select one.

If you input an unknown variable it is shown in red – the variable has yet to be defined.

Once activated variables can be selected and their display format defined.

If the value requires further processing before use, such as trigonometric functions, you can select these via the calculator icon.

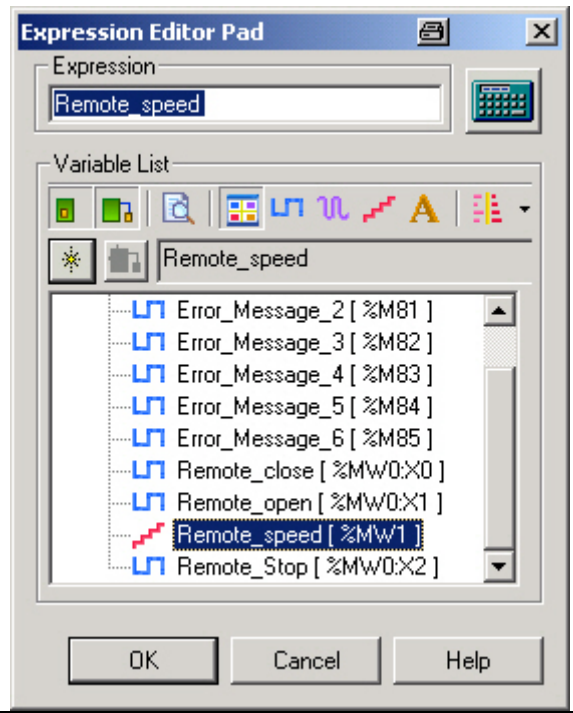
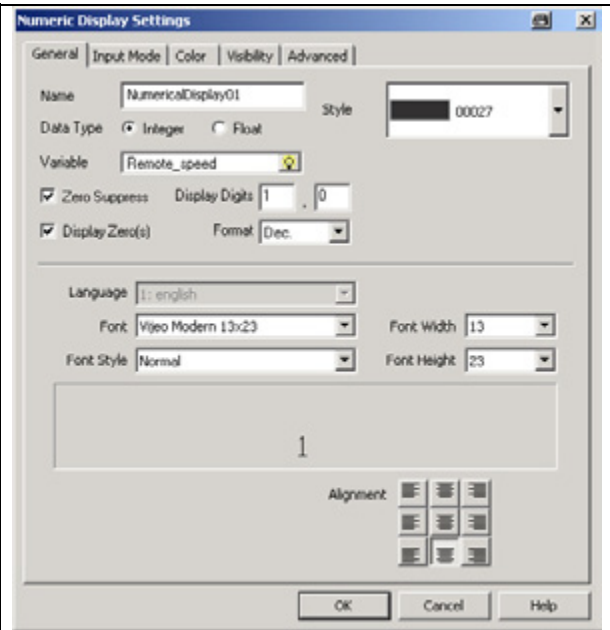

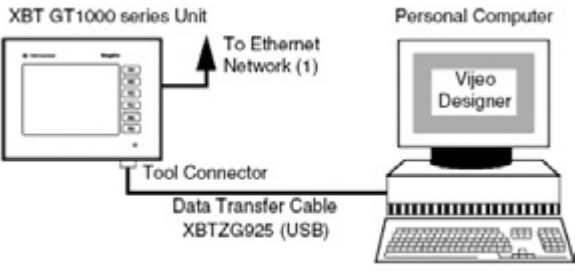
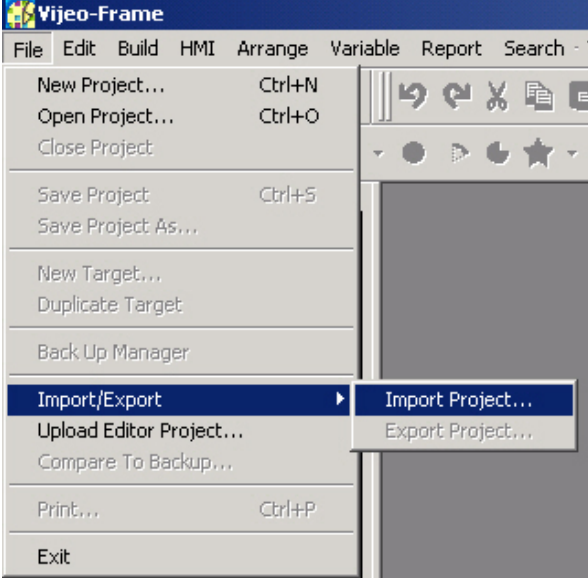
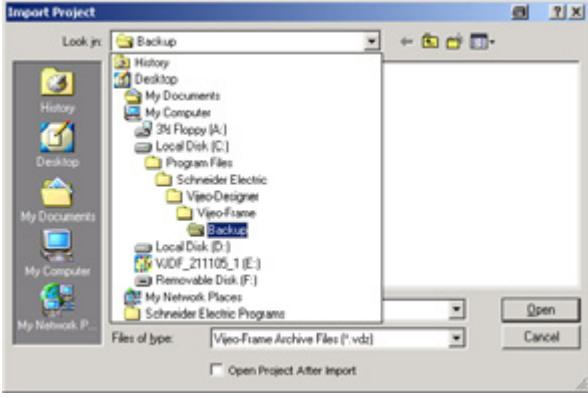
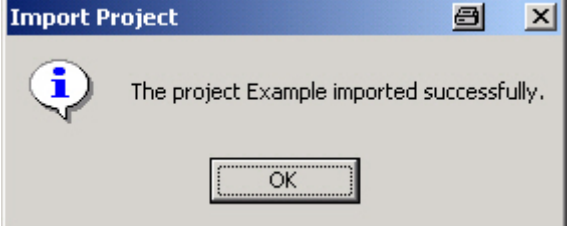

Import and transfer an existing program

<p>1</p>	<p>In order to transfer the program from the PC to the terminal, the two must be connected to each other using the XBTZG925 communication cable.</p>	 <p>(1) Not available on XBT GT1100</p>
<p>2</p>	<p>To be able to import a project you have to close the active project first.</p> <p>In the File menu, select Import/Export ->Import Project...</p> <p>The Import Project dialog opens.</p>	
<p>3</p>	<p>Vijeo-Designer import/export files are normally stored in the folder backup.</p> <p>Select the file named "Example.vdz" and import it into Vijeo-Designer by double-clicking on it or clicking Open.</p>	
<p>4</p>	<p>After finishing the import successfully, you will receive a message that you must acknowledge with OK.</p>	

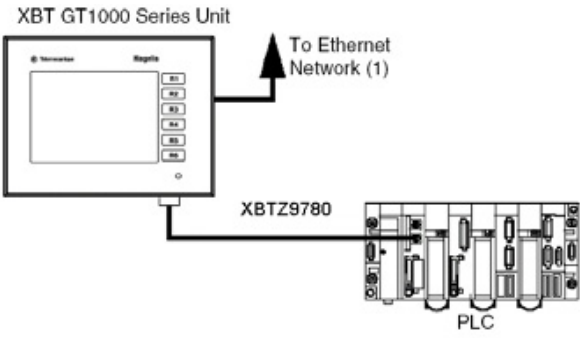
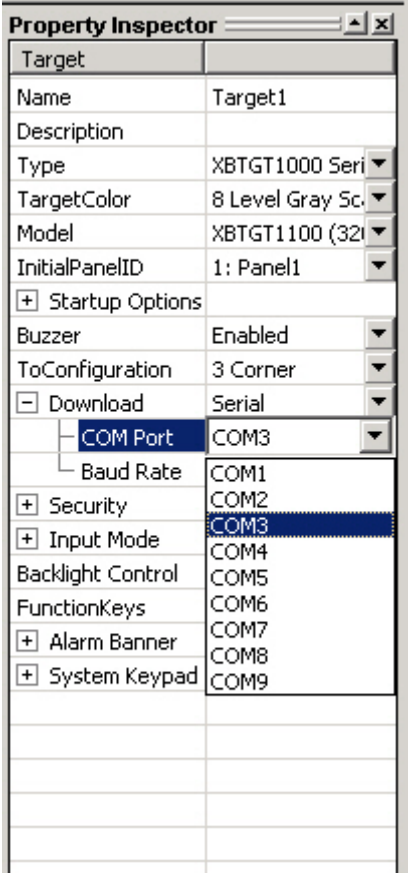
Import and transfer an existing program
Contd.

<p>5</p>	<p>To communicate with the Twido please connect the XBT GT's RJ45 jack with the Mini-Din connector on port 1 of the Twido using the cable XBTZ9780.</p>	 <p>(1) Not available on XBT GT1100</p>																																														
<p>6</p>	<p>Before you download the application to the HMI device please check for the correct COM port settings in the Property Inspector.</p> <p><i>If in doubt, please check the hardware settings of your systems according to step 5 of the runtime installer description.</i></p>	 <table border="1"> <thead> <tr> <th colspan="2">Property Inspector</th> </tr> </thead> <tbody> <tr> <td>Target</td> <td></td> </tr> <tr> <td>Name</td> <td>Target1</td> </tr> <tr> <td>Description</td> <td></td> </tr> <tr> <td>Type</td> <td>XBTGT1000 Seri</td> </tr> <tr> <td>TargetColor</td> <td>8 Level Gray Sc.</td> </tr> <tr> <td>Model</td> <td>XBTGT1100 (32)</td> </tr> <tr> <td>InitialPanelID</td> <td>1: Panel1</td> </tr> <tr> <td colspan="2">+ Startup Options</td> </tr> <tr> <td>Buzzer</td> <td>Enabled</td> </tr> <tr> <td>ToConfiguration</td> <td>3 Corner</td> </tr> <tr> <td colspan="2">- Download</td> </tr> <tr> <td> COM Port</td> <td>COM3</td> </tr> <tr> <td> Baud Rate</td> <td>COM1</td> </tr> <tr> <td colspan="2">+ Security</td> </tr> <tr> <td> Input Mode</td> <td>COM2</td> </tr> <tr> <td> Backlight Control</td> <td>COM3</td> </tr> <tr> <td> FunctionKeys</td> <td>COM4</td> </tr> <tr> <td> Alarm Banner</td> <td>COM5</td> </tr> <tr> <td> System Keypad</td> <td>COM6</td> </tr> <tr> <td></td> <td>COM7</td> </tr> <tr> <td></td> <td>COM8</td> </tr> <tr> <td></td> <td>COM9</td> </tr> </tbody> </table>	Property Inspector		Target		Name	Target1	Description		Type	XBTGT1000 Seri	TargetColor	8 Level Gray Sc.	Model	XBTGT1100 (32)	InitialPanelID	1: Panel1	+ Startup Options		Buzzer	Enabled	ToConfiguration	3 Corner	- Download		COM Port	COM3	Baud Rate	COM1	+ Security		Input Mode	COM2	Backlight Control	COM3	FunctionKeys	COM4	Alarm Banner	COM5	System Keypad	COM6		COM7		COM8		COM9
Property Inspector																																																
Target																																																
Name	Target1																																															
Description																																																
Type	XBTGT1000 Seri																																															
TargetColor	8 Level Gray Sc.																																															
Model	XBTGT1100 (32)																																															
InitialPanelID	1: Panel1																																															
+ Startup Options																																																
Buzzer	Enabled																																															
ToConfiguration	3 Corner																																															
- Download																																																
COM Port	COM3																																															
Baud Rate	COM1																																															
+ Security																																																
Input Mode	COM2																																															
Backlight Control	COM3																																															
FunctionKeys	COM4																																															
Alarm Banner	COM5																																															
System Keypad	COM6																																															
	COM7																																															
	COM8																																															
	COM9																																															

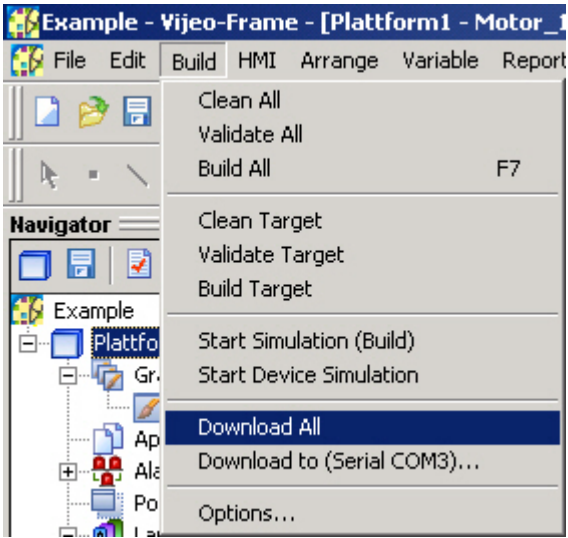
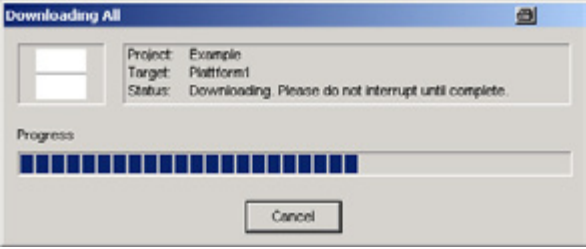
Import and transfer an existing program
Contd.

<p>7</p>	<p>To check or validate the application, select:</p> <p>Build->Download All</p> <p>Once validated, you can transfer it to the target device.</p>	 <p>The screenshot shows a software window titled 'Example - Vijeo-Frame - [Plattform1 - Motor_1]'. The 'Build' menu is open, and 'Download All' is highlighted. Other menu items include 'Clean All', 'Validate All', 'Build All' (F7), 'Clean Target', 'Validate Target', 'Build Target', 'Start Simulation (Build)', 'Start Device Simulation', 'Download to (Serial COM3)...', and 'Options...'.</p>
<p>8</p>	<p>During the download a progress bar will be displayed.</p>	 <p>The screenshot shows a 'Downloading All' dialog box. It displays 'Project: Example', 'Target: Plattform1', and 'Status: Downloading. Please do not interrupt until complete.' A progress bar is partially filled with blue. A 'Cancel' button is at the bottom.</p>
<p>9</p>	<p>Once the download is finished, the Magelis XBT GT1100 automatically establishes a connection with the Twido.</p> <p>By using the R1, R2 and R3 keys on the front of the display you can control the application.</p> <p>By touching the field Speed you can change the speed of the motor(s)</p>	 <p>The screenshot shows the Magelis XBT GT1100 HMI display. The screen displays 'Typical Implementation' with a list of components: 'Twido modular', 'Altivar 11/31/71', and 'XBTGT-1100'. Below this, it says 'Motor #1' and lists several status indicators: 'Safety / E-stop OK', 'Circuit breaker OK', 'Frequency drive OK', 'Mainten. switch OK', and 'Limit switches OK'. On the right side of the screen, there are six physical buttons labeled R1 through R6. The 'Speed' field is highlighted in red.</p>

PLC

Introduction

The PLC chapter describes how to initialize, parameterize and load the program to the PLC in order to implement the functional description described above. The PLC program is created with Twidosoft.

Pre-conditions

The following conditions must be met in order to carry out the steps described below:

- The Twidosoft programming tool is installed on your PC
- The "Example.twd" Twidosoft project is available in the default directory that has been set up (C:\Program Files\Schneider Electric\TwidoSoft\Applications)
- The Twido PLC is switched on and supplied with power
- The PLC and the PC are linked to one another via the PC <> Twido programming cable (TSXPCX3031).

Setting up communication

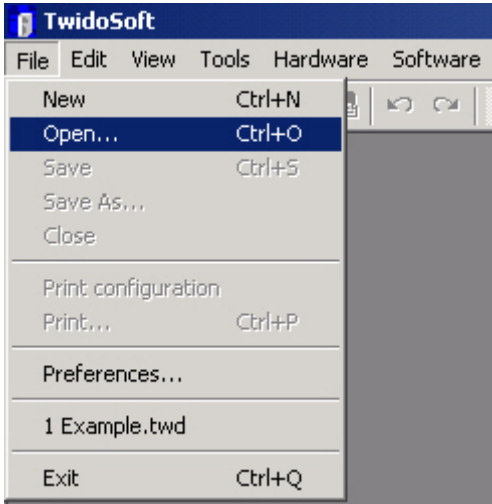
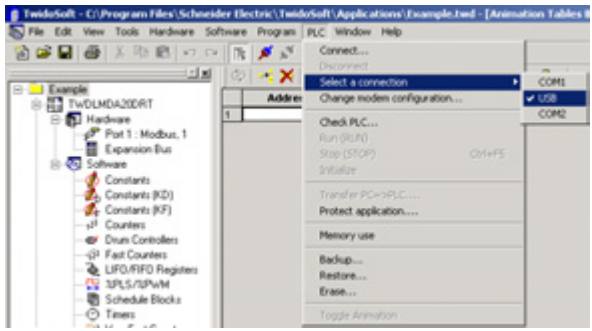
1	<p>Once the Twido programming software has been launched, start by calling up the "Example.twd" PLC program.</p> <p>To do this, select:</p> <p>File->Open</p> <p>The application default directory in which the file should be located is displayed.</p>	 <p>The screenshot shows the TwidoSoft application window with the 'File' menu open. The 'Open...' option is highlighted in blue. Other menu items include 'New', 'Save', 'Save As...', 'Close', 'Print configuration', 'Print...', 'Preferences...', '1 Example.twd', and 'Exit'.</p>
2	<p>Once the program has been loaded, communication with the PLC must be set up. Select:</p> <p>PLC->Select a connection</p> <p>to invoke the dialog for the port definition; in this case, USB.</p>	 <p>The screenshot shows the TwidoSoft application window with the 'PLC' menu open. The 'Select a connection' option is highlighted in blue. Other menu items include 'Connect...', 'Change modes configuration...', 'Check PLC...', 'Run (RUN)', 'Stop (STOP)', 'Initialize', 'Transfer PC->PLC...', 'Protect application...', 'Memory use', 'Backup...', 'Restore...', 'Erase...', and 'Toggle Animation'.</p>

Transferring and running a program

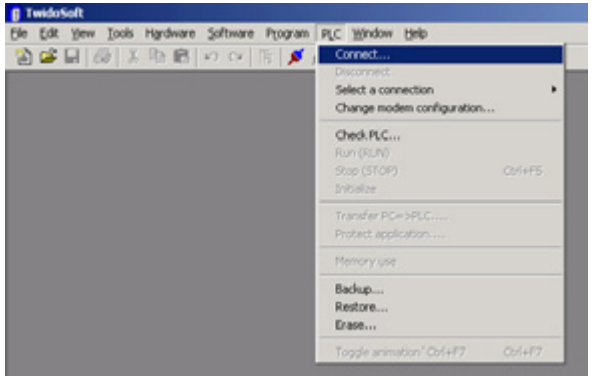
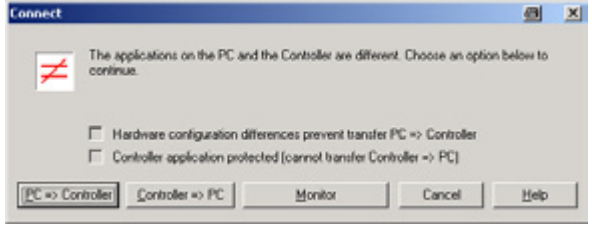
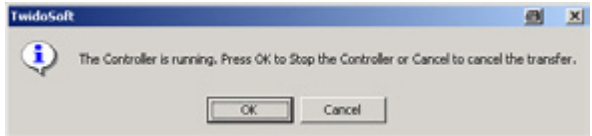
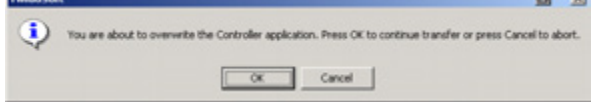
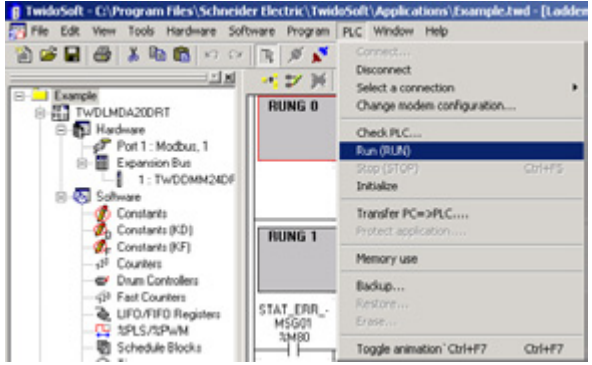
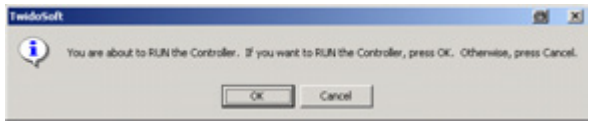
<p>1</p>	<p>To transfer the program, the PLC and the PC must remain connected to each other via the communication cable.</p> <p>Connect the devices and select</p> <p>PLC->Connect</p> <p>to create an online link to the PLC so that you can download the program.</p>	
<p>2</p>	<p>Before a program is downloaded to the PLC for the first time, Twidosoft informs you that the program and the PLC content are different. In this case, click on</p> <p>PC-> Controller</p> <p>to transfer the program to the PLC.</p>	
<p>3</p>	<p>If an application is already running on the controller, Twidosoft asks if it may stop the PLC and overwrite the existing application. Press OK to stop the controller and download the application.</p>	
<p>4</p>	<p>Now click on OK to overwrite the existing application in the controller.</p>	
<p>5</p>	<p>When the transfer is completely finished the controller needs to be started.</p> <p>Select</p> <p>PLC->Run</p> <p>or click on the run icon in the toolbar.</p>	
<p>6</p>	<p>To confirm the run action on the controller click the OK button.</p>	

Data exchange

Introduction

In this chapter, the individual points between which data is transferred via a bus system, (e.g., Modbus, Modbus Plus or TCP/IP) and that are not linked to digital or analog hardware interfaces, are listed.

This list defines:

- The devices concerned in each case
- The direction of transfer
- The symbolic name *and*
- The direct bus address on the device concerned.

Read and write data direction

Device 1 XBT GT1100 (Modbus master)		Device 2 Twido (Modbus slave)	
Address	Designation	Address	Designation
%MW0:X0	Open	%MW0:X0	RMT_CMD_OPEN
%MW0:X1	Close	%MW0:X1	RMT_CMD_CLOSE
%MW0:X2	Stop	%MW0:X2	RMT_CMD_STOP
%MW1	Speed	%MW1	RMT_SPEED

Data direction (device 1 reads from device 2)

Device 1 XBT GT1100 (Modbus master)		Device 2 Twido (Modbus slave)	
Address	Designation	Address	Designation
%M80	Safety not OK	%M80	ERR_STAT_MESS01
%M81	Motor protection off	%M81	ERR_STAT_MESS02
%M82	Variable speed drive error	%M82	ERR_STAT_MESS03
%M83	Maintenance switch off	%M83	ERR_STAT_MESS04
%M84	Limit switch error	%M84	ERR_STAT_MESS05
%M85	Spare error	%M85	ERR_STAT_MESS06

Devices

Introduction

This chapter describes the steps required to initialise and configure the devices to attain the described system function.



PowerSuite software is used to initialize and parameterize the devices.

General

The ATV11 parameters can be entered via the front panel on the device itself. However, using PowerSuite allows you to:

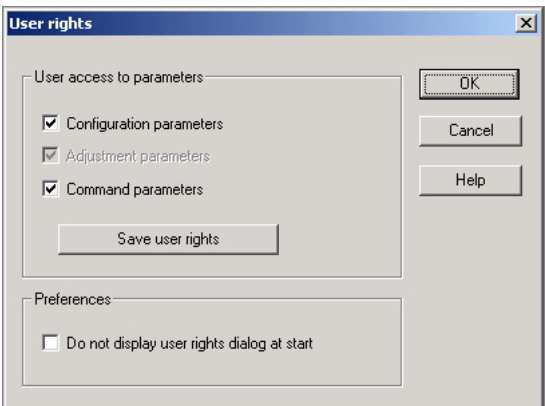

- save the data on your PC
- print out the documentation *and*
- optimize the parameters online.

Configuration

<p>1</p>	<p>The window opposite appears once the program has started up.</p> <p>Once you have read the warning message, advance to the next screen using the shortcut Alt+F.</p>	
<p>2</p>	<p>The next dialog allows you to define general user rights. You do not have to make any changes in this dialog.</p> <p>Proceed to the selection of the type of VSD by clicking OK.</p>	
<p>3</p>	<p>Select the device type in this window.</p> <p>In this example, we select ATV 11.</p>	

Continued on next page

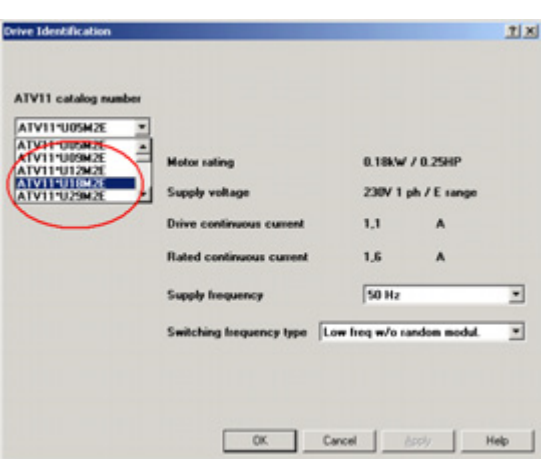
Configuration
Contd.

<p>4</p>	<p>The models available in the ATV11 series are displayed in the drop-down list on the left of the dialog (circled in red). Select the appropriate variable speed drive by clicking on its part number.</p> <p>The values assigned to the device are displayed on the right-hand side; only the frequency should be set here in accordance with the actual conditions. Next, select Apply and OK in order to transfer the configuration.</p>	
<p>5</p>	<p>Here you could make further settings; however, in this example we use the default values.</p>	
<p>6</p>	<p>Once this procedure has been completed, you can store the parameters on the PC. Use the diskette icon in the toolbar (or the corresponding menu item).</p>	

Transferring parameters

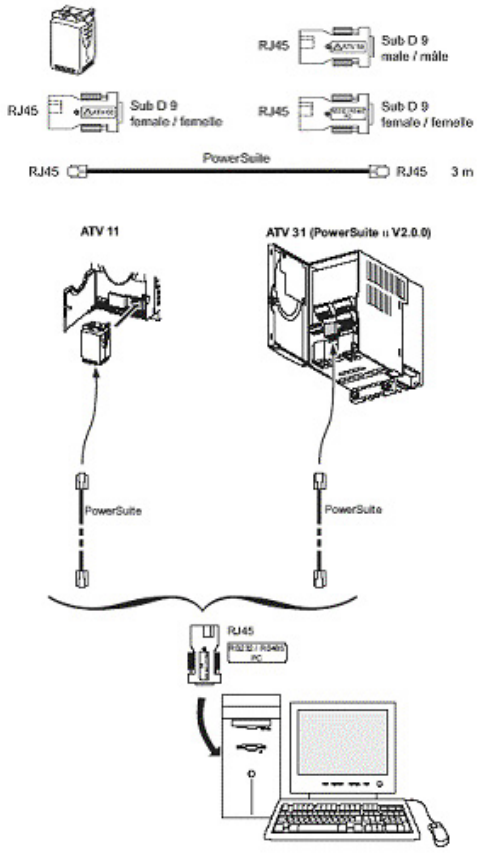
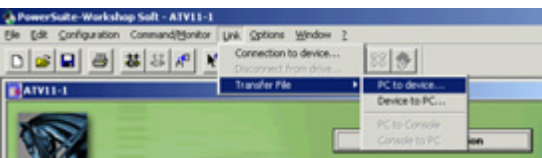
<p>1</p>	<p>Check the connection between the PC and the Altivar.</p>	 <p>The diagram illustrates the hardware setup for parameter transfer. At the top, a 3m PowerSuite cable is shown with RJ45 connectors at both ends. Above the cable, three RJ45 to Sub D 9 adapters are shown: one male-to-female, one female-to-female, and one female-to-female. Below the cable, two Altivar devices are shown: an ATV 11 and an ATV 31 (PowerSuite v2.0.0). Each device is connected to the PowerSuite cable via a female-to-female adapter. The PowerSuite cable is then connected to a PC via an RJ45 to Sub D 9 adapter.</p>
<p>2</p>	<p>You can now transfer the parameters to the ATV by selecting:</p> <p>Link->Transfer File</p> <p>and then</p> <p>PC to device.</p>	 <p>The screenshot shows the 'PowerSuite-Workshop Soft - ATV11-1' application window. The 'Link' menu is open, and the 'Transfer File' option is selected. A sub-menu is displayed with the following options: 'PC to device...', 'Device to PC...', 'PC to Console', and 'Console to PC'. The 'PC to device...' option is highlighted.</p>

Appendix

Detailed components list

Hardware components

Item	No.	Description	Part no.	Rev./Vers.
1.1	1	Master switch	VCF02GE	
1.2	1	Emergency stop switch housing	XALK178G	
1.3	1	Preventa emergency stop relay, cat. 3	XPSAC3721	
1.4	2	Contactor, 9 A, 24 V DC operated, 3-pole, AC3, 1x NO + 1x NC	LC1D09BD	
1.5	1	2-button push button housing, empty	XALD02	
1.6	1	Selector switch, 3 positions, locking-type	XB5AD33	
1.7	1	Label holder 30x40 "forward-0-back"	ZBY2384	
1.8	1	Illuminated button red, flat	ZB5AW343	
1.9	1	Auxiliary switch module with red LED + 1 auxiliary switch (1x NO)	ZB5AW0B42	
1.10	1	Label holder 30x40 "stop"	ZBY2304	
1.11	1	3-button push button housing empty	XALD03	
1.12	1	Illuminated button blue, flat	ZB5AW363	
1.13	1	Auxiliary switch module with blue LED + 1 auxiliary switch (1x NO)	ZB5AW0B61	
1.14	1	Label holder 30x40 "emergency stop"	ZBY2330	
1.15	1	Indicator lamp white, flat	XB5AVB1	
1.16	1	Label holder 30x40 "on"	ZBY2311	
1.17	2	Position switch Universal (final positions)	XCKP2118P16	
1.18	2	Miniature circuit breaker C60N 1P 2A C	23726	
1.19	1	Miniature circuit breaker C60N 1P+N 1A C	24183	
1.20	1	Phaseo power supply 24 V DC/1.2 A	ABL7CEM24012	
1.21	1	Twido PLC modular device with 20 I/Os	TWDLMDA20DRT	V3.2
1.22	1	XBT GT 3,8" Magelis operator terminal	XBTGT1100	
1.23	1	Magelis/PLC connection cable	XBTZ9780	
1.24	1	Motor circuit breaker, 9 to 14 A, adjustable	GV2ME16	
1.25	1	Maintenance switch	VBF02GE	
1.26	1	Auxiliary contact block for maintenance switch	VZ7	
1.27	1	Altivar ATV11 variable speed drive	ATV11PU18M2E	
1.28	1	<i>Altivar adapter for 35mm mounting rail</i>	VW3A11851	<i>option</i>

Software components

Item	No.	Description	Part no.	Rev./Vers.
2.1	1	Twidosoft programming software incl. USB cable	TWDSPU1003V10M	3.2
2.1a	1	Twidosoft programming software	TWDSPU1002V10M	3.2
2.1b	1	Twido programming USB cable	TSXPCX3031	
2.2	1	Vijeo-Designer configuration software for Magelis XBT G/XBT GT incl. USB cable	VJDSUDTGSV43M	4.3.0
2.2a	1	Vijeo-Designer configuration software for Magelis XBT G/XBT GT	VJDSUDTGSV43M	4.3.0
2.2b	1	XBT GT programming USB cable	XBTZG925	
2.3	1	PowerSuite parameterization software	VW3A8104	1.5
2.4	1	Altivar set of connection accessories	VW3A8106	

Component protection classes

**Recommended installation locations/
Protection class**

Components	In the field, on site IP 55/IP 65	Front IP 65	Control Cabinet IP 20
Master and maintenance switch	X		
Emergency stop switch housing	X		
Contactors, 9 A, 24 V DC operated, 3-pole AC 3, 1x NO + 1x NC			X
2-button/3-button push button housing, empty	X		
Selector switch, 3 positions		X	
Illuminated buttons, all colors, flat		X	
Auxiliary switch module with LED + 1 auxiliary switch (1x NO), all colors			X
Label holder 30x40, all texts	X		
Position switch Universal	X		
Miniature circuit breaker, all types and ratings			X
Motor protection switch, all types and ratings			X
Phaseo power supply 24 V DC/1.2 A			X
Preventa emergency stop relay			
Twido PLC			X
Magelis XBT GT1100		X	

Characteristics of the system

General

The data listed below relates to the system and its features as described and specified in this document. The values represented are determined by:

- The number of I/O points
- The number of bus nodes (if present)
- The number of instructions/operations
- Memory usage

Scan time and cycle time

A cycle time of 2 ms was not exceeded with the present configuration including the required application code. The memory usage of the Twido PLC specified and used in this document was 18% for system/configuration data and 2% for the logic component.

Trials with additionally integrated extension modules (a digital I/O module with 16 inputs and 8 relay outputs as well as an analog module with 1 output and 2 inputs, which was used as the I/O level for 2 PID controllers) showed that the cycle time could increase to a maximum of 6 ms. When using the aforementioned two additional extension modules, memory usage for system data rose to 22% but, as expected, memory usage of the logic components did not change.

Component Features

Twido PLC



The PLC used in this example comprises the power base of a Twido modular PLC and a programming set comprising software and a programming cable (TWDLMDA20DRT + TWDSPU1001V10M):

- 24 V DC
- 12 digital inputs
- 8 digital relay outputs
 - Can be extended up to a maximum of 7 modules (analog and communication modules are also possible)

3 programming languages:

- Ladder Language (LD)
- Instruction List (IL)
- Sequential Function Chart/Grafcet (SFC)

Predefined functions:

- Drum controller
- High-speed counter up to 5 kHz
- Very high-speed counter up to 20 kHz
- Frequency meter 1 to 20 kHz
- Register areas for LIFO/FIFO execution
- PWM/PCS output
- External PLC start
- PID controller

Phaseo power supply unit

ABL7CEM24012



- 100 to 240 V AC/24 V DC
 - 1.2 A secondary
 - Short-circuit-proof
-

Altivar VSD**ATV11 HU18M2E**

- 0.75 kW, 230 V AC, single-phase
- Integrated class B EMC filter
- Temperature range: -10 to + 50°C
- Speed range from 1 to 20 (0 to 200 Hz)
- Speed control with flow vector check
- Protection of drive and motor
- Compact design, side-by-side installation also possible on a top-hat rail

**Circuit
breaker****GV2ME16**

- 9 to 14 A
 - Thermal and magnetic (170 A) activation
 - Lockable
-

Contact

Author	Phone	E-mail
Schneider Electric GmbH Customer & Market System & Architecture Architecture Definition Support	+49 6182 81 2555	cm.systems@de.schneider-electric.com

Schneider Electric GmbH
Steinheimer Strasse 117
D - 63500 Seligenstadt
Germany

As standards, specifications and designs change from time to time, please ask for confirmation of the information given in this publication.