Features

- Integer Unit Based on SPARC V7 High-performance RISC Architecture
- Optimized Integrated 32/64-bit Floating-point Unit
- On-chip Peripherals
 - EDAC and Parity Generator and Checker
 - Memory Interface
 - Chip Select Generator
 - Waitstate Generation
 - Memory Protection
 - DMA Arbiter
 - Timers
 - General Purpose Timer (GPT)
 - Real-time Clock Timer (RTCT)
 - Watchdog Timer (WDT)
 - Interrupt Controller with 5 External Inputs
 - General Purpose Interface (GPI)
 - Dual UART
- Speed Optimized Code RAM Interface
- 8- or 40-bit boot-PROM (Flash) Interface
- IEEE 1149.1 Test Access Port (TAP) for Debugging and Test Purposes
- Fully Static Design
- Performance: 12 MIPs/3 MFlops (Double Precision) at SYSCLK = 15 MHz
- Core Consumption: 1.0W Typ. at 20 MIPs/0.7W typ. at 10 MIPs
- Operating Range: 4.5V to 5.5V⁽¹⁾ -55°C to +125°C
- Total Dose Radiation Capability (Parametric and Functional): 300 KRADs (Si)
- SEU Event Rate Better than 3 E-8 Error/Component/Day (Worst Case)
- Latch-up Immunity Better than (LET) 100 MeV-cm²/mg
- Quality Grades: ESA SCC, QML Q or V
- Package: 256 MQFPF; Bare Die

Note: 1. For 3.3V capability see the TSC695FL datasheet on the Atmel site.

Description

The TSC695F (ERC32 Single-Chip) is a highly integrated, high-performance 32-bit RISC embedded processor implementing the SPARC architecture V7 specification. It has been developed with the support of the ESA (European Space Agency), and offers a full development environment for embedded space applications.

The processor is manufactured using the Atmel 0.5 μm radiation tolerant (≥ 300 KRADs (Si)) CMOS enhanced process (RTP). It has been specially designed for space, as it has on-chip concurrent transient and permanent error detection.

The TSC695F includes an on-chip Integer Unit (IU), a Floating Point Unit (FPU), a Memory Controller and a DMA arbiter. For real-time applications, the TSC695F offers a high security watchdog, two timers, an interrupt controller, parallel and serial interfaces. Fault tolerance is supported using parity on internal/external buses and an EDAC on the external data bus. The design is highly testable with the support of an On-Chip Debugger (OCD), and a boundary scan through JTAG interface.



Rad-Hard 32-bit SPARC Embedded Processor

TSC695F

Rev. 4118H-AERO-06/03



Block Diagram

Figure 1. TSC695F Block Diagram

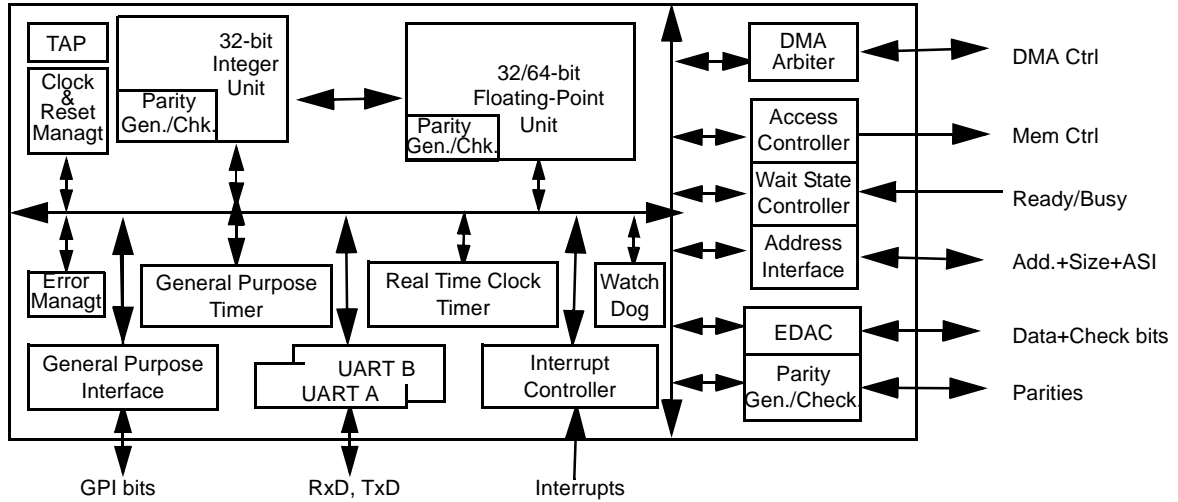

Pin Descriptions

For pin assignment, refer to package section.

Table 1. Pin Descriptions

Signal	Type	Active	Description	
RA[31:0]	I/O,		32-bit registered address bus	Output buffer: 400 pF
RAPAR	I/O	High	Registered address bus parity	-
RASI[3:0]	I/O		4-bit registered address space identifier	-
RSIZE[1:0]	I/O		2-bit registered bus transaction size	-
RASPAR	I/O	High	Registered ASI and SIZE parity	-
CPAR	I/O	High	Control bus parity	-
D[31:0]	I/O		32-bit data bus	-
CB[6:0]	I/O		7-bit check-bit bus	-
DPAR	I/O	High	Data bus parity	-
RLDSTO	I/O	High	Registered atomic load-store	-
ALE	O	Low	Address latch enable	-
DXFER	I/O	High	Data transfer	-
LOCK	I/O	High	Bus lock	-
RD	I/O	High	Read access	-
WE	I/O	Low	Write enable	-
WRT	I/O	High	Advanced write	-
MHOLD	O	Low	Memory bus hold	MHOLD+FHOLD +BHOLD+FCCV
MDS	O	Low	Memory data strobe	-
MEXC	O	Low	Memory exception	-
PROM8	I	Low	Select 8-bit wide PROM	-
BA[1:0]	O		Latched address used for 8-bit wide boot PROM	-
ROMCS	O	Low	PROM chip select	-
ROMWRT	I	Low	ROM write enable	-
MEMCS[9:0]	O	Low	Memory chip select	Output buffer: 400 pF
MEMWR	O	Low	Memory write strobe	Output buffer: 400 pF

Table 1. Pin Descriptions (Continued)

Signal	Type	Active	Description	
$\overline{\text{OE}}$	O	Low	Memory output enable	Output buffer: 400 pF
$\overline{\text{BUFFEN}}$	O	Low	Data buffer enable	-
DDIR	O	High	Data buffer direction	-
$\overline{\text{DDIR}}$	O	Low	Data buffer direction	-
$\overline{\text{IOSEL}}[3:0]$	O	Low	I/O chip select	-
$\overline{\text{IOWR}}$	O	Low	I/O and exchange memory write strobe	-
$\overline{\text{EXMCS}}$	O	Low	Exchange memory chip select	-
$\overline{\text{BUSRDY}}$	I	Low	Bus ready	-
$\overline{\text{BUSERR}}$	I	Low	Bus error	-
$\overline{\text{DMAREQ}}$	I	Low	DMA request	-
$\overline{\text{DMAGNT}}$	O	Low	DMA grant	-
DMAAS	I	High	DMA address strobe	-
$\overline{\text{DRDY}}$	O	Low	Data ready during DMA access	-
$\overline{\text{IUERR}}$	O	Low	IU error	-
$\overline{\text{CPUHALT}}$	O	Low	Processor (IU & FPU) halt and freeze	-
$\overline{\text{SYSERR}}$	O	Low	System error	-
$\overline{\text{SYSHALT}}$	I	Low	System halt	-
SYSAV	O	High	System availability	-
$\overline{\text{NOPAR}}$	I	Low	No parity	-
INULL	O	High	Integer unit nullify cycle	-
INST	O	High	Instruction fetch	Used to check the execute stage of IU instruction pipeline
FLUSH	O	High	FPU instruction flush	
DIA	O	High	Delay instruction annulled	
RTC	O	High	Real Time Clock Counter output	-
RxA/RxB	I		Receive data UART 'A' and 'B'	Input trigger
TxA/TxB	O		Transmit data UART 'A' and 'B'	-
GPI[7:0]	I/O		GPI input/output	Input trigger
GPIINT	O	High	GPI interrupt	-
$\overline{\text{EXTINT}}[4:0]$	I		External interrupt	Input trigger
$\overline{\text{EXTINTACK}}$	O	High	External interrupt acknowledge	-
IWDE	I	High	Internal watch dog enable	-
$\overline{\text{EWDINT}}$	I	High	External watch dog input interrupt	Input trigger
WDCLK	I		Watch dog clock	-
CLK2	I		Double frequency clock	-
SYSCLK	O		System clock	-
$\overline{\text{RESET}}$	O	Low	Output reset	-
$\overline{\text{SYSRESET}}$	I	Low	System input reset	Input trigger
$\overline{\text{TMODE}}[1:0]$	I		Factory test mode	Functional mode=00
DEBUG	I	High	Software debug mode	-
TCK	I		Test (JTAG) clock	-
$\overline{\text{TRST}}$	I	Low	Test (JTAG) reset	pull-up \approx 37 k Ω
TMS	I		Test (JTAG) mode select	pull-up \approx 37 k Ω
TDI	I		Test (JTAG) data input	pull-up \approx 37 k Ω
TDO	O		Test (JTAG) data output	-
VCCI/VSSI			Main internal power	-
VCCO/VSSO			Output driver power	-

Note: If not specified, the output buffer type is 150 pF, the input buffer type is TTL.

System Architecture

The TSC695F is to be used as an embedded processor requiring only memory and application specific peripherals to be added to form a complete on-board computer. All other system support functions are provided by the core.

Figure 2. System Architecture Based on TSC695F

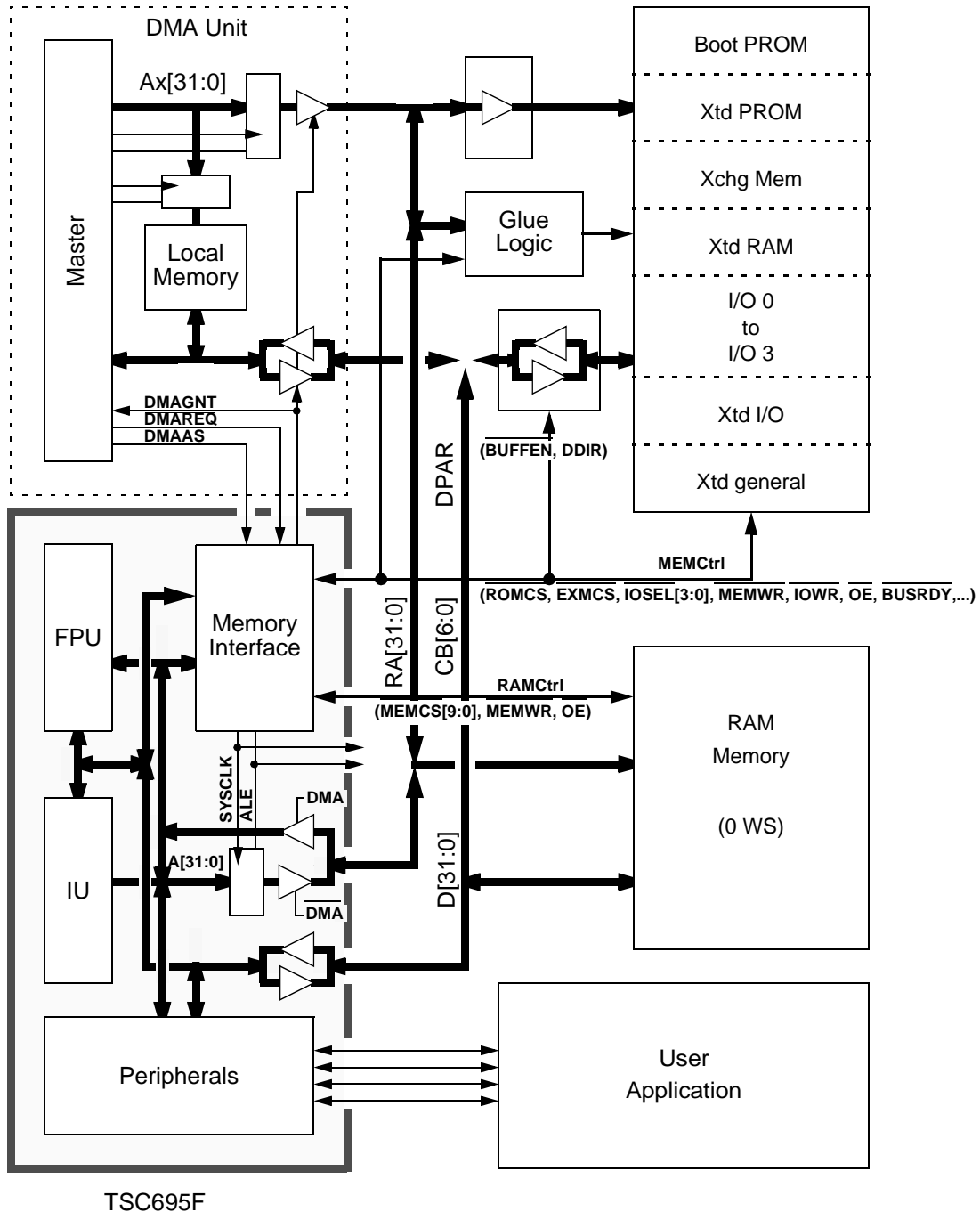

Product Description

Integer Unit

The Integer Unit (IU) is designed for highly dependable space and military applications, and includes support for error detection. The RISC architecture makes the creation of a processor that can execute instructions at a rate approaching one instruction per processor clock possible.

To achieve that rate of execution, the IU employs a four-stage instruction pipeline that permits parallel execution of multiple instructions.

- Fetch - The processor outputs the instruction address to fetch the instruction.
- Decode - The instruction is placed in the instruction register and is decoded. The processor reads the operands from the register file and computes the next instruction address.
- Execute - The processor executes the instruction and saves the results in temporary registers. Pending traps are prioritized and internal traps are taken during this stage.
- Write - If no trap is taken, the processor writes the result to the destination register.

All four stages operate in parallel, working on up to four different instructions at a time. A basic 'single-cycle' instruction enters the pipeline and completes in four cycles.

By the time it reaches the write stage, three more instructions have entered and are moving through the pipeline behind it. So, after the first four cycles, a single-cycle instruction exits the pipeline and a single-cycle instruction enters the pipeline on every cycle. Of course, a 'single-cycle' instruction actually takes four cycles to complete, but they are called single cycle because with this type of instruction the processor can complete one instruction per cycle after the initial four-cycle delay.

Floating-point Unit

The Floating Point Unit (FPU) is designed to provide execution of single and double-precision floating-point instructions concurrently with execution of integer instructions by the IU. The FPU is compliant to the ANSI/IEEE-754 (1985) floating-point standard.

The FPU is designed for highly dependable space and military applications, and includes support for concurrent error detection and testability.

The FPU uses a four stage instruction pipeline consisting of fetch, decode, execute and write stages (F, D, E and W). The fetch unit captures instructions and their addresses from the data and address buses. The decode unit contains logic to decode the floating-point instruction opcodes. The execution unit handles all instruction execution. The execution unit includes a floating-point queue (FP queue), which contains stored floating-point operate (FPop) instructions under execution and their addresses. The execution unit controls the load unit, the store unit, and the datapath unit. The FPU depends upon the IU to access all addresses and control signals for memory access. Floating-point loads and stores are executed in conjunction with the IU, which provides addresses and control signals while the FPU supplies or stores the data. Instruction fetch for integer and floating-point instructions is provided by the IU.

The FPU provides three types of registers: f registers, FSR, and the FP queue. The FSR is a 32-bit status and control register. It keeps track of rounding modes, floating-point trap types, queue status, condition codes, and various IEEE exception information. The floating-point queue contains the floating-point instruction currently under execution, along with its corresponding address.





Instruction Set

TSC695F instructions fall into six functional categories: load/store, arithmetic/logical/shift, control transfer, read/write control register, floating-point, and miscellaneous. Please refer to SPARC V7 Instruction-set Manual.

Note: The execution of IFLUSH will cause an illegal instruction trap.

On-chip Peripherals

Memory Interface

The TSC695F is designed to allow easy interfacing to internal/external memory resources.

Table 2. Memory Mapping

Memory Contents	Start Address	Size (bytes)	Data Size and Parity Options	
Boot PROM	0x00000000	128K → 16M	8-bit mode	No parity/-No EDAC/-Only byte write
			40-bit mode	Parity + EDAC mandatory/-Only word write
Extended PROM	0x01000000	Max: 15M	8-bit mode	No parity/-No EDAC/-Only byte write
			40-bit mode	Parity + EDAC mandatory/-Only word write
Exchange Memory	0x01F00000	4k → 512k	Parity + EDAC option/-Only word write	
System Registers	0x01F80000	512K (124 used)	Parity/-Only word read/write access	
RAM (8 blocks)	0x02000000	8*32K → 8*4M	Parity + EDAC option/-All data sizes allowed	
Extended RAM	0x04000000	Max: 192M		
I/O Area 0	0x10000000	0 → 16M	Parity option/-All data sizes allowed	
I/O Area 1	0x11000000	0 → 16M		
I/O Area 2	0x12000000	0 → 16M		
I/O Area 3	0x13000000	0 → 16M		
Extended I/O Area	0x14000000	Max: 1728M		
Extended General	0x80000000	Max: 2G	No parity/-All data sizes allowed	

System Registers

The system registers are only writable by IU in the supervisor mode or by DMA during halt mode.

Table 3. System Registers Address Map

System Register Name		Address
System Control Register	SYSTR	0x 01F8 0000
Software Reset	SWRST	0x 01F8 0004
Power Down	PDOWN	0x 01F8 0008
System Fault Status Register	SYSFSR	0x 01F8 00A0
Failing Address Register	FAILAR	0x 01F8 00A4
Error & Reset Status Register	ERRRSR	0x 01F8 00B0
Test Control Register	TESCTR	0x 01F8 00D0

Table 3. System Registers Address Map (Continued)

System Register Name		Address
Memory Configuration Register	MCNFR	0x 01F8 0010
I/O Configuration Register	IOCNFR	0x 01F8 0014
Waitstate Configuration Register	WSCNFR	0x 01F8 0018
Access Protection Segment 1 Base Register	APS1BR	0x 01F8 0020
Access Protection Segment 1 End Register	APS1ER	0x 01F8 0024
Access Protection Segment 2 Base Register	APS2BR	0x 01F8 0028
Access Protection Segment 2 End Register	APS2ER	0x 01F8 002C
Interrupt Shape Register	INTSHR	0x 01F8 0044
Interrupt Pending Register	INTPDR	0x 01F8 0048
Interrupt Mask Register	INTMKR	0x 01F8 004C
Interrupt Clear Register	INTCLR	0x 01F8 0050
Interrupt Force Register	INTFCR	0x 01F8 0054
Watchdog Timer Register	WDOGTR	0x 01F8 0060
Watchdog Timer Trap Door Set	WDOGST	0x 01F8 0064
Real Time Clock Timer <Counter> Register	RTCCR	0x 01F8 0080
Real Time Clock Timer <Scaler> Register	RTCSR	0x 01F8 0084
General Purpose Timer <Counter> Register	GPTCR	0x 01F8 0088
General Purpose Timer <Scaler> Register	GPTSR	0x 01F8 008C
Timers Control Register	TIMCTR	0x 01F8 0098
General Purpose Interface Configuration Register	GPICNFR	0x 01F8 00A8
General Purpose Interface Data Register	GPIDATR	0x 01F8 00AC
UART 'A' Rx & Tx Register	UARTAR	0x 01F8 00E0
UART 'B' Rx & Tx Register	UARTBR	0x 01F8 00E4
UART Status Register	UARTSR	0x 01F8 00E8

Wait-state and Time-out Generator

It is possible to control the wait-state generation by programming a Wait-state Configuration Register. The maximum programmable number of wait-states is applied by default at reset.

It is possible to program the number of wait-states for the following combinations:

- RAM read and write
- PROM read and write (i.e. EEPROM or Flash write)
- Exchange Memory read/write
- Four individual I/O peripherals read/write

A bus time-out function of 256 system clock cycles is provided for the bus ready controlled memory areas, i.e., the Extended PROM, Exchange Memory, Extended RAM,





Extended I/O and the Extended General areas.

- EDAC**
- The TSC695F includes a 32-bit EDAC (Error Detection And Correction). Seven bits (CB[6:0]) are used as check bits over the data bus. The Data Bus Parity signal (DPA) is used to check and generate the odd parity over the 32-bit data bus. This means that altogether 40 bits are used when the EDAC is enabled.
- The TSC695F EDAC uses a 7-bit Hamming code which detects any double bit error on the 40-bit bus as a non-correctable error. In addition, the EDAC detects all bits stuck-at-one and stuck-at-zero failure for any nibble in the data word as a non-correctable error. Stuck-at-one and stuck-at-zero for all 32 bits of the data word is also detected as a non-correctable error.
- Memory and I/O Parity**
- The TSC695F handles parity towards memory and I/O in a special way. The processor can be programmed to use no parity, only parity or parity and EDAC protection towards memory and to use parity or no towards I/O. The signal used for the parity bit is DPA.
- Memory Redundancy**
- Programming the Memory Configuration Register, the TSC695F provides chip selects for two redundant memory banks for replacement of faulty banks.
- Memory Access Protection**
- Unimplemented Areas - Access to all unimplemented memory areas are handled by the TSC695F and detected as illegal.
 - RAM Write Access Protection - The TSC695F can be programmed to detect and mask write accesses in any part of the RAM. The protection scheme is enabled only for data area, not for the instruction area. The programmable write access protection is based on two segments.
 - Boot PROM Write Protection - The TSC695F supports a qualified PROM write for an 8-bit wide PROM and/or for a 40-bit wide PROM.
- DMA**
- DMA Interface**
- The TSC695F supports Direct Memory Access (DMA). The DMA unit requests access to the processor bus by asserting the DMA request signal (\overline{DMAREQ}). When the DMA unit receives the \overline{DMAGNT} signal in response, the processor bus is granted. In case the processor is in the power-down mode the processor is permanent tri-stated, and a \overline{DMAREQ} will directly give a \overline{DMAGNT} . The TSC695F includes a DMA session time-out function.
- Bus Arbiter**
- The TSC695F always has the lowest priority on the system bus.
- Traps**
- A trap is a vectored transfer of control to the supervisor through a special trap table that contains the first four instructions of each trap handler. The base address of the table is established by supervisor and the displacement, within the table, is determined by the trap type. Two categories of traps can appear.

Synchronous Traps

Table 4. Synchronous Traps

Trap		Priority	Trap Type (tt)	Comments	
Reset		1	–	Sources: SYSRESET* pin software reset watchdog reset IU or System error reset	
Hardware Error	Non-restartable, imprecise error	2	2.1	64h	Severe error requiring a re-boot TSC695F enters (if not masked) in halt or reset mode
	Non-restartable, precise error		2.2	62h	Error not removable, PC & nPC OK TSC695F enters (if not masked) in halt or reset mode
	Register file error		2.3	65h	Special case of non-restartable, precise error. TSC695F enters (if not masked) in halt or reset mode
	Restartable, late error		2.4	63h	Retrying instruction but PC & nPC have to be re-adjusted TSC695F enters (if not masked) in halt or reset mode
	Restartable, precise error	2.5	61h	Retrying instruction TSC695F enters (if not masked) in halt or reset mode	
Instruction access (Error on instruction fetch)		3	01h	Parity error on control bus Parity error on data bus Parity error on address bus Access to protected or unimplemented area Uncorrectable error in memory Bus time out Bus error	
Illegal Instruction		4	02h	–	
Privileged instruction		5	03h	–	
FPU disabled		6	04h	–	
Window	Overflow	7	05h	During SAVE instruction or trap taken	
	Underflow		06h	During RESTORE instruction or RETT instruction	
Memory address not aligned		8	07h	–	
FPU exception	Non-restartable error	9	9.1	Severe error, cannot restart the instruction	
	Data bus error		9.2	Parity error on FPU data bus	
	Restartable error		9.3	Can be removed restarting the instruction	
	Sequence error		9.4	–	
	Unimplemented FPop		9.5	–	
	IEEE exceptions:	9.6	08h	Invalid operation Division by zero Overflow Underflow Inexact	

Table 4. Synchronous Traps (Continued)

Trap	Priority	Trap Type (tt)	Comments
Data access exception (Error on data load)	10	09h	Idem "instruction access" System register access violation
Tag overflow	11	0Ah	TADDccTV and TSubccTV instructions
Trap instructions	12	80h to FFh	Trap on integer condition codes (Ticc)

Table 5. Interrupts or Asynchronous Traps

Trap	Priority	Trap Type (tt)	Comments	
Watchdog time-out	13	1Fh	Internal or external (EWDINT pin)	
External INT 4	14	1Eh	EXTINTAK on only one of EXTINT[4:0]	
Real time clock timer	15	1Dh	—	
General purpose timer	16	1Ch	—	
External INT 3	17	1Bh	EXTINTAK on only one of EXTINT[4:0]	
External INT 2	18	1Ah	EXTINTAK on only one of EXTINT[4:0]	
DMA time-out	19	19h	—	
DMA access error	20	18h	—	
UART Error	21	17h	—	
Correctable error in memory	22	16h	Data read OK but source not updated	
UART B	Data ready Transmitter ready	23	15h	—
UART A	Data ready Transmitter ready	24	14h	—
External INT 1	25	13h	EXTINTAK on only one of EXTINT[4:0]	
External INT 0	26	12h	EXTINTAK on only one of EXTINT[4:0]	
Masked hardware errors	27	11h	Logical OR of: IU hardware error masked IU error mode masked System hardware error masked	

It is possible to mask each individual interrupt (except Watchdog time-out). The interrupts in the Interrupt Pending Register are cleared automatically when the interrupt is acknowledged.

By programming the Interrupt Shape Register, it is possible to define the external interrupts to either be active low or active high and to define the external interrupts to either be edge or level sensitive.

Timers

In software debug mode the timers are controlled by a system register bit and the external pin DEBUG.

General Purpose Timer

The General Purpose Timer (GPT) provides, in addition to a generalized counter function, a mechanism for setting the step size in which actual time counts are performed.

GPT is clocked by the internal system clock. They are possible to program to be either of single-shot type or periodical type and in both cases generate an interrupt when the delay time has elapsed. The current value of the scaler and counter of the GPT can be read.

Real Time Clock Timer

The only functional differences between the two timers are that the Real Time Clock Timer (RTCT) has an 8-bit scaler (16-bit scaler for GPT) and that the RTCT interrupt has higher priority than the GPT interrupt.

RTCT information is available on RTC output pin.

Watchdog Timer

Setting the external pin IWDE to V_{CC} enables the internal watchdog timer. Otherwise the watchdog function must be externally provided.

The watchdog is supplied from a separate external input (WDCLK). After reset, the timer is enabled and starts running with the maximum range. If the timer is not refreshed (reprogrammed) before the counter reaches zero value, an interrupt is sent. Simultaneously, the timer starts counting a reset time-out period. If the timer is not acknowledged before the reset time-out period elapses, a reset is applied to TSC695F.

UARTs

Two full duplex asynchronous receiver transmitters (UART) are included. In software debug mode the UART's are controlled by system register bits.

The data format of the UART's is eight bits. It is possible to choose between even or odd parity, or no parity, and between one and two stop bits. The UART's provide double buffering, i.e. each UART consists of a transmitter holding register, a receiver holding register, a transmitter shift register, and a receiver shift register. Each of these registers are 8-bit wide. For each UART a RX and TX Register is provided. The UART's generate an interrupt each time a byte has been received or a byte has been sent. There is another interrupt to indicate errors.

The baud rate of both the UART's is programmable. The clock is derived either from the system clock or can use the watchdog clock.

General Purpose Interface

The General Purpose Interface (GPI) is an 8-bit parallel I/O port. Each pin can be configured as an input or an output.

A falling or rising edge detection is made on each selected GPI inputs. Every input transition on GPI generates an external positive pulse on GPIINT pin of two SYSCLK width.

Execution Modes

Reset Mode

Reset mode is entered when:

- The $\overline{\text{SYSRES}}$ input is asserted
- Software reset which is caused by the software writing to a Software Reset Register
- Watchdog reset which is caused by a Watchdog counter time-out
- Error reset which is caused by a hardware parity error



This $\overline{\text{RESET}}$ output has a minimum of 1024 SYSClk width to allow the usage of Flash memories.

The error and Reset Status Register contain the source of the last processor reset.

Run Mode

In this mode the IU/FPU is executing, while all peripherals are running (if software enabled).

System Halt Mode

System Halt mode is entered when the $\overline{\text{SYSHALT}}$ input is asserted. In this mode, the IU and FPU are frozen, while the timers (including the internal watchdog timer) and UART's are stopped.

Power Down Mode

This mode is entered by writing to the Power-down Register. In this mode, the IU and FPU are frozen. The TSC695F leaves the power-down mode if an external interrupt is asserted.

Error Halt Mode

Error Halt mode is entered under the following circumstances:

- A internal hardware parity error.
- The IU enters error mode.

The only way to exit Error Halt Mode is through Cold Reset by asserting $\overline{\text{SYSRESET}}$.

Error Handler

The TSC695F has one error output signal ($\overline{\text{SYSERR}}$) which indicates that an unmasked error has occurred. Any error signalled on the error inputs from the IU and the FPU is latched and reflected in the Error and Reset Status Register. By default, an error leads to a processor halt.

Parity Checking

The TSC695F includes:

- Parity checking and generation (if required) on the external data bus
- Parity checking on the external address bus
- Parity checking on ASI and SIZE
- Parity checking and generation on all system registers
- Parity generation and checking on the internal control bus to the IU

All external parity checking can be disabled using the $\overline{\text{NOPAR}}$ signal.

System Clock

The TSC695F uses CLK2 clock input directly and creates a system clock signal by dividing CLK2 by two. It drives SYSClk pin with a nominal 50% duty cycle for the application. It is highly recommended that only SYSClk rising edge is used as reference as far as possible.

System Availability

The SYSAV bit in the Error and Reset Status Register can be used by software to indicate system availability.

Test Mode

The TSC695F includes a number of software test facilities such as EDAC test, Parity test, Interrupt test, Error test and a simple Test Access Port. These test functions are controlled using the Test Control Register.

Test and Diagnostic Hardware Functions

A variety of TSC695F test and diagnostic hardware functions, including boundary scan, internal scan, clock control and On-chip Debugger, are controlled through an IEEE 1149.1 (JTAG) standard Test Access Port (TAP).

Test Access Port

The TAP interfaces to the JTAG bus via 5 dedicated pins on the TSC695F chip. These pins are:

- TCK (input): Test Clock
- TMS (input): Test Mode Select
- TDI (input): Test Data Input
- TDO (output): Test Data Output
- $\overline{\text{TRST}}$ (input): Test Reset

Instruction Register

Five standard instructions are supported by the TSC695F TAP.

Binary Value	Name of Instruction	Data Register	Scan Chain Accessed
00. 0000	EXTEST	Boundary Scan Register	Boundary scan chain
00. 0001	SAMPLE/PRELOAD	Boundary Scan Register	Boundary scan chain
00. 0011	INTEST	Boundary Scan Register	Boundary scan chain
11. 1111	BYPASS	Bypass Register	Bypass register
10. 0000	IDCODE	Device ID Register	ID register scan chain

Debugging

The design is highly testable with the support of an On-Chip Debugger (OCD), an internal and boundary scan through JTAG interface.



Electrical Characteristics

Absolute Maximum Ratings

Military Range.....	-55°C to +125°C
Storage Temperature	-65°C to +150°C
Supply Voltage.....	-0.5V to +7.0V
Input Voltage.....	-0.5V to +7.0V

Note: Stresses at or above those listed under “Absolute Maximum Ratings” may cause permanent damage to the device. This is a stress rating only and functional operation of the device at these or any other conditions above those indicated in the operational sections of this specification is not implied. Exposure to absolute maximum rating conditions may affect device reliability.

DC Characteristics

Table 6. DC Characteristics at $V_{DD} 5V \pm 10\%$

Symbol	Parameter	Min	Typ	Max	Unit	Test Conditions
$V_{IL\ trigger}$	Input Low Voltage for trigger input	–	–	0.8	V	$V_{CC} = 4.5$ to $5.5V$
$V_{IH\ trigger}$	Input High Voltage for trigger input	3.0	–	–	V	$V_{CC} = 4.5$ to $5.5V$
ΔVT	Input Hysteresis for trigger input	–	0.9	–	V	$V_{CC} = 4.5$ to $5.5V$
$V_{IL\ TTL}$	Input Low Voltage for TTL input	–	–	0.8	V	$V_{CC} = 4.5$ to $5.5V$
$V_{IH\ TTL}$	Input High Voltage for TTL input	2.2	–	–	V	$V_{CC} = 4.5$ to $5.5V$
$V_{OL\ 400\ pF}$	Output Low Voltage for 400 pF buffer	–	0.3	0.4	V	$V_{CC} = 4.5$ to $5.5V$ $I_{OL} = 12\ mA$
$V_{OH\ 400\ pF}$	Output High Voltage for 400 pF buffer	2.4	0.3	–	V	$V_{CC} = 4.5$ to $5.5V$ $I_{OH} = -16\ mA$
$V_{OL\ 150\ pF}$	Output Low Voltage for 150 pF buffer	–	0.3	0.4	V	$V_{CC} = 4.5$ to $5.5V$ $I_{OL} = 4\ mA$
$V_{OH\ 150\ pF}$	Output High Voltage for 150 pF buffer	2.4	4.3	–	V	$V_{CC} = 4.5$ to $5.5V$ $I_{OH} = -6\ mA$
$I_{CC\ OP}$	Operating Supply Current for core processor	–	–	230	mA	$V_{CC} = 5.5V, f = 25\ MHz$
		–	–	210		$V_{CC} = 5.5V, f = 20\ MHz$
		–	–	170		$V_{CC} = 5.5V, f = 10\ MHz$
$I_{CC\ PD}$	Power Down Supply Current for core processor	–	–	41	mA	$V_{CC} = 5.5V, f = 25MHz$
		–	–	38		$V_{CC} = 5.5V, f = 20\ MHz$
		–	–	30		$V_{CC} = 5.5V, f = 10\ MHz$

Capacitance Ratings

Parameter	Description	Max
C _{IN}	Input Capacitance	7 pF
C _{OUT}	Output Capacitance	8 pF
C _{IO}	Input/Output Capacitance	8 pF

AC Characteristics

Table 7. AC Characteristics (SYSCLK Freq. = 25 MHz – 5V ±10%) C_{load} = 50 pF, V_{ref} = 2.5V

Parameter	Min (ns)	Max (ns)	Comment	Reference Edge
t1	20	–	CLK2 period	–
t2	40	–	SYSCLK period	–
t3	9.75	–	CLK2 high and low pulse width	–
t4	–	6.5	RA(31:0) RAPAR RSIZE RLDSTO output delay	SYSCLK+
t5	–	12.5	MEMCS*(9:0) ROMCS* EXMCS* output delay	SYSCLK+
t6	–	15	DDIR DDIR* output delay	SYSCLK+
t7	–	23.5	MEMWR* IOWR* output delay formula: 13.5 ns + 1/4 t2	SYSCLK- or SYSCLK+
t8	–	20.5	OE* HL output delay formula: 10.5 ns + 1/4 t2	SYSCLK+
t9	t9_1	11.5	Data setup time during load	SYSCLK+
	t9_2	9	Data setup time during load mNOPAR = 0 rpa = rec = either 1 or 0	SYSCLK+
t10	5	–	Data hold time during load	SYSCLK+
t11	–	28	Data output delay	SYSCLK-
t12	8	–	Data output valid to HZ – guaranteed by design	SYSCLK+
t13	–	19	CB output delay	SYSCLK+
t14	–	13	ALE* output delay	SYSCLK-
t15	–	21	BUFFEN* HL output delay formula: 11 ns + 1/4 t2	SYSCLK+
t16	–	15	MHOLD* output delay – guaranteed by design	SYSCLK+
t17	–	15	MDS* DRDY* output delay	SYSCLK+
t20	–	15	MEXC* output delay	SYSCLK-
t21	10	–	RASI(3:0) RSIZE(1:0) RASPAR setup time	SYSCLK+
t22	3	–	RASI(3:0) RSIZE(1:0) RASPAR hold time	SYSCLK+
t23	–	13	BOOT PROM address output delay	SYSCLK+



Table 7. AC Characteristics (SYSCLK Freq. = 25 MHz – 5V ±10%) C_{load} = 50 pF, V_{ref} = 2.5V (Continued)

Parameter	Min (ns)	Max (ns)	Comment	Reference Edge
t24	12	–	BUSRDY* setup time	SYSCLK+
t25	0	–	BUSRDY* hold time	SYSCLK+
t27	–	15	IOSEL output delay	SYSCLK+ HL SYSCLK- LH
t28	12	20	DMAAS setup time formula of max: $\frac{1}{2} t2$	SYSCLK+
t29	0	20	DMAAS hold time formula of max: $\frac{1}{2} t2$	SYSCLK-
t30	12	–	DMAREQ* setup time	SYSCLK+
t31	–	15	DMAGNT* output delay	SYSCLK+
t32	10	–	RA(31:0) RAPAR CPAR setup time	SYSCLK+
t33	3	–	RA(31:0) RAPAR CPAR hold time	SYSCLK+
t36	100	–	TCK period	-
t37	10	–	TMS setup time	TCK+
t38	4	–	TMS hold time	TCK+
t39	10	–	TDI setup time	TCK+
t40	10	–	TDI hold time	TCK+
t41	–	20	TDO output delay	TCK-
t46	–	22	INULL output delay	SYSCLK+
t48	–	22	RESET* CPUHALT* output delay	SYSCLK+
t49	–	20	SYSERR* SYSAV output delay	SYSCLK+
t50	–	20	IUERR* output delay	SYSCLK+
t52	12	–	EXTINT(4:0) setup time	SYSCLK-
t53	0	–	EXTINT(4:0) hold time	SYSCLK+
t54	–	15	EXTINTACK output delay	SYSCLK+
t56	–	8.5	OE* LH output delay (no DMA mode)	SYSCLK+
t57	–	9	BUFFEN* LH output delay	SYSCLK+
t60	–	22	INST output delay	SYSCLK+
t61	20	–	Data output delay to low-Z – guaranteed by design formula: $10 \text{ ns} + \frac{1}{4} t2$	SYSCLK+

Figure 3. 150 pF Buffer Response (Data from simulation)

Pad 150 pF

ΔT_{plh} ($V_{ref} V_{cc}/2$)

Table 1: Pad 150 pf – 4.5 upto 5.5V

Cload	ΔT_{plh} min	ΔT_{plh} typ	ΔT_{plh} max
50	0.0000	0.0000	0.0000
100	2.4192	3.3103	5.2914
150	4.7737	6.5738	10.5592
200	7.1202	9.8337	15.8213
250	9.4619	13.0972	21.0917

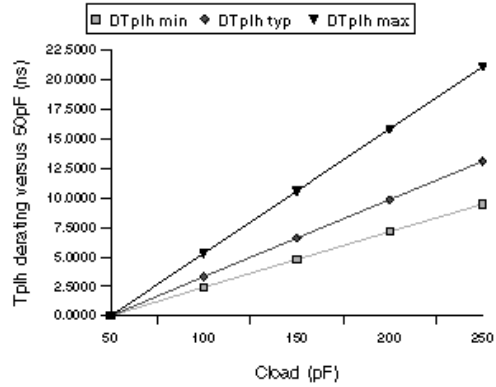

ΔT_{phl} ($V_{ref} V_{cc}/2$)

Table 2: Pad 150 pf – 4.5 upto 5.5V

Cload	ΔT_{phl} min	ΔT_{phl} typ	ΔT_{phl} max
50	0.0000	0.0000	0.0000
100	2.2148	2.7939	4.1585
150	4.3495	5.4990	8.2316
200	6.4402	8.1574	12.2909
250	8.5185	10.8017	16.3407

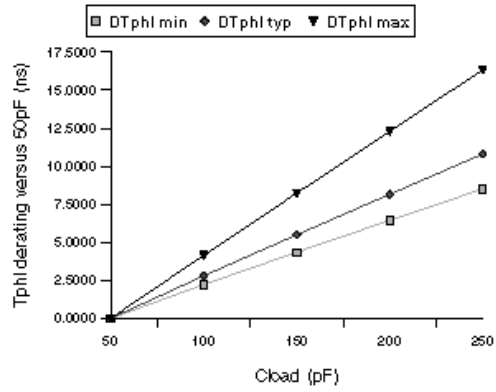

T_{rise} ($V_{ref} 10\% - 90\% V_{cc}$)

Table 3: Pad 150 pf – 4.5 upto 5.5V

Cload	T_{rise} min	T_{rise} typ	T_{rise} max
50	6.1867	8.5791	13.7101
100	11.2347	15.7401	25.6081
150	16.2439	22.8687	37.5005
200	21.4093	30.4199	49.2181
250	26.6452	37.5970	60.9228

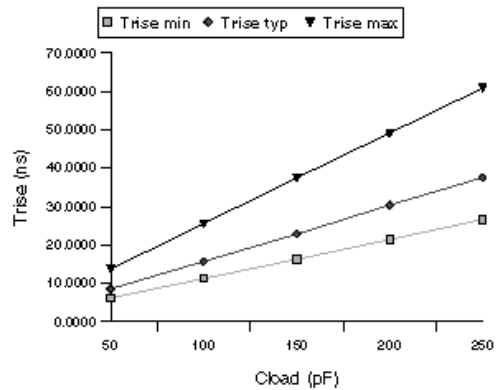

T_{fall} ($V_{ref} 10\% - 90\% V_{cc}$)

Table 4: Pad 150 pf – 4.5 upto 5.5V

Cload	T_{fall} min	T_{fall} typ	T_{fall} max
50	6.9397	8.4643	11.9360
100	12.7286	15.4097	21.7423
150	18.5518	22.4212	31.6795
200	24.4566	29.5245	41.7298
250	30.2526	36.5310	51.8139

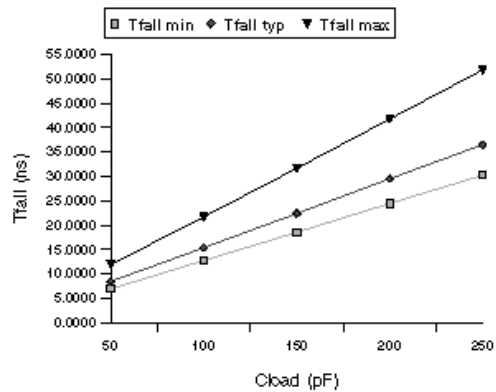

Figure 4. 400 pF Buffer Response (Data from simulation)

Pad 400 pF

ΔT_{plh} ($V_{ref} V_{cc}/2$)

Table 5: Pad 400 pf – 4.5 upto 5.5V

Cload	ΔT_{plh} min	ΔT_{plh} typ	ΔT_{plh} max
50	0.0000	0.0000	0.0000
150	2.1601	2.8177	4.1663
250	3.9576	5.2119	7.8496
350	5.6386	7.4818	11.4194
450	7.2733	9.7184	14.9618

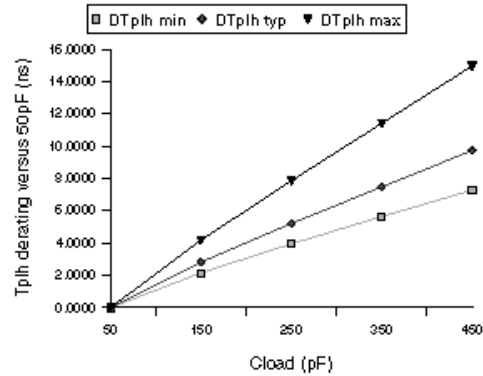

ΔT_{phi} ($V_{ref} V_{cc}/2$)

Table 6: Pad 400 pf – 4.5 upto 5.5V

Cload	ΔT_{phi} min	ΔT_{phi} typ	ΔT_{phi} max
50	0.0000	0.0000	0.0000
150	3.1851	3.0049	3.8823
250	5.8077	5.5149	7.2185
350	8.2550	7.8953	10.4133
450	10.6267	10.1911	13.5505

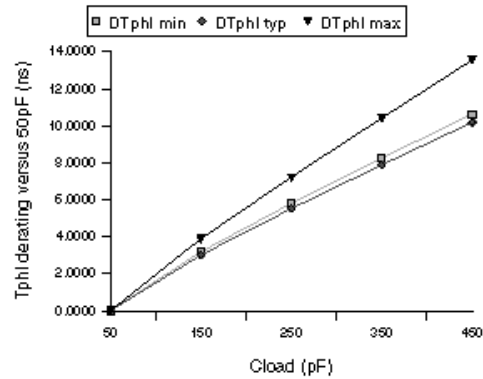

Trise ($V_{ref} 10\% - 90\% V_{cc}$)

Table 7: Pad 400 pf – 4.5 upto 5.5V

Cload	Trise min	Trise typ	Trise max
50	3.1666	4.2291	6.2607
150	6.6263	9.0002	13.8948
250	10.0104	13.6901	21.7273
350	13.4251	18.5600	29.5949
450	16.7768	23.2394	37.3774

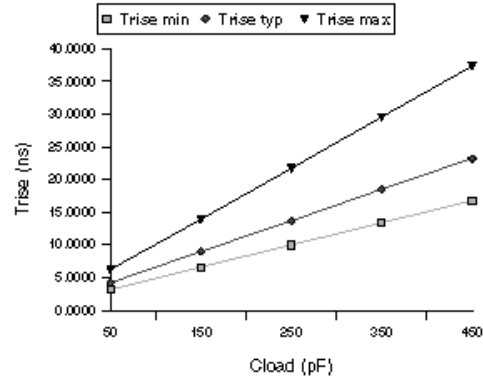

Tfall ($V_{ref} 10\% - 90\% V_{cc}$)

Table 8: Pad 400 pf – 4.5 upto 5.5V

Cload	Tfall min	Tfall typ	Tfall max
50	4.3868	4.4176	5.7938
150	9.1148	9.5715	12.7515
250	13.6747	14.6117	19.6288
350	18.2245	19.6467	26.6077
450	22.8149	24.6813	33.5087

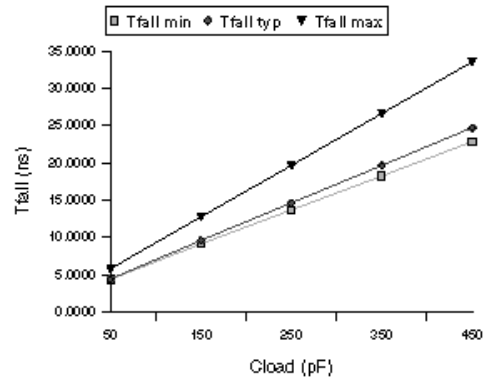

Figure 5. OE*/400 pF Buffer Response (Data from simulation)

Pad OE*/400 pF

ΔT_{plh} ($V_{ref} V_{cc}/2$)

Table 9: Pad OE*/400 pf – 4.5 upto 5.5V

Cload	ΔT_{plh} min	ΔT_{plh} typ	ΔT_{plh} max
50	0.0000	0.0000	0.0000
150	1.7340	2.4097	3.9279
250	3.2361	4.5051	7.4136
350	4.6539	6.5011	10.8206
450	6.0630	8.4769	14.2225

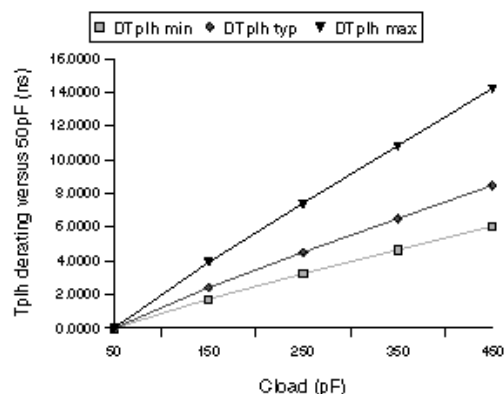

ΔT_{phl} ($V_{ref} V_{cc}/2$)

Table 10: Pad OE*/400 pf – 4.5 upto 5.5V

Cload	ΔT_{phl} min	ΔT_{phl} typ	ΔT_{phl} max
50	0.0000	0.0000	0.0000
150	1.6894	2.2905	3.4123
250	3.1654	4.2887	6.3744
350	4.5512	6.2013	9.2070
450	5.9127	8.0612	11.9794

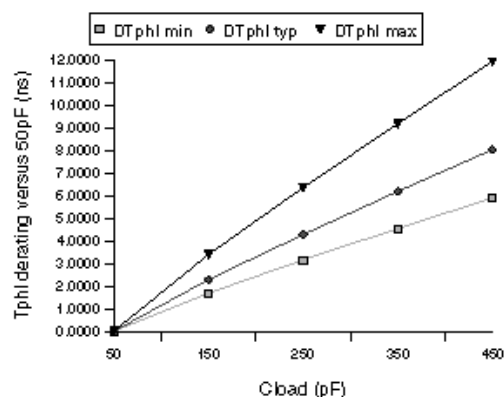

Trise ($V_{ref} 10\% - 90\% V_{cc}$)

Table 11: Pad OE*/400 pf – 4.5 upto 5.5V

Cload	Trise min	Trise typ	Trise max
50	2.6422	3.7344	6.0309
150	5.9759	8.3789	13.8250
250	9.1822	12.9451	21.6527
350	12.4493	17.5564	30.2306
450	15.7472	22.0852	38.1191

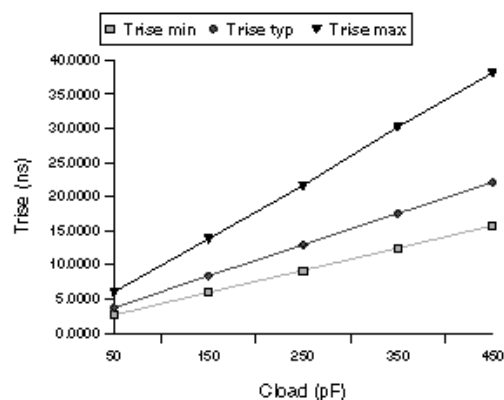

Tfall ($V_{ref} 10\% - 90\% V_{cc}$)

Table 12: Pad OE*/400 pf – 4.5 upto 5.5V

Cload	Tfall min	Tfall typ	Tfall max
50	2.7381	3.7130	5.4558
150	6.8280	9.0224	12.94
250	10.7990	14.2062	20.1478
350	15.0116	19.5230	27.8361
450	18.9112	24.9462	35.3409

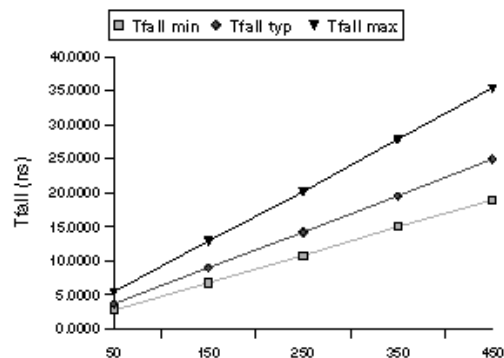

Timing Diagrams

Figure 6. RAM Fetch, RAM Load and RAM Store Sequence - n Waitstates for Read, m Waitstates for Write

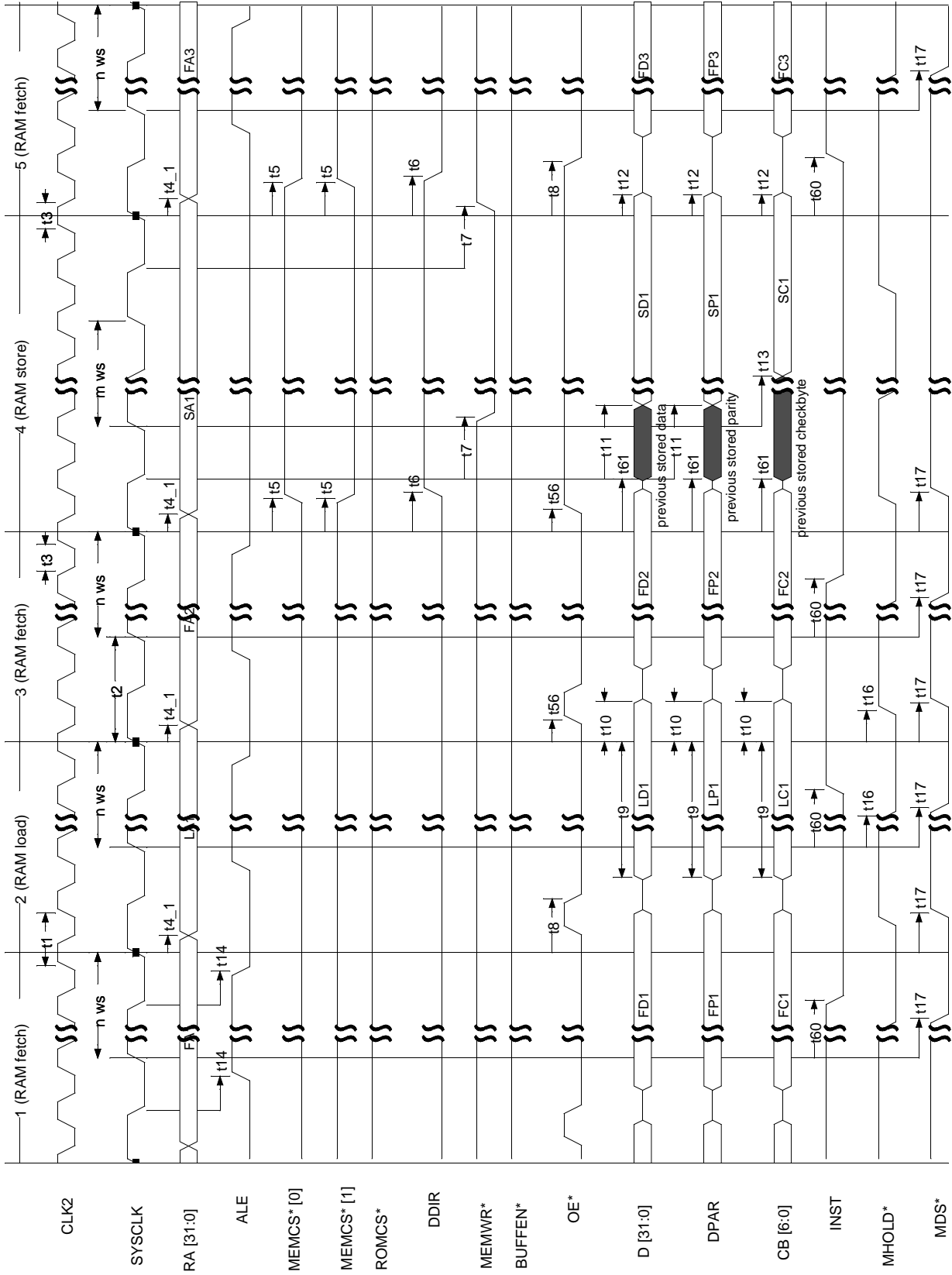

Figure 7. RAM Atomic-load-store byte Sequence - 0 Waitstate

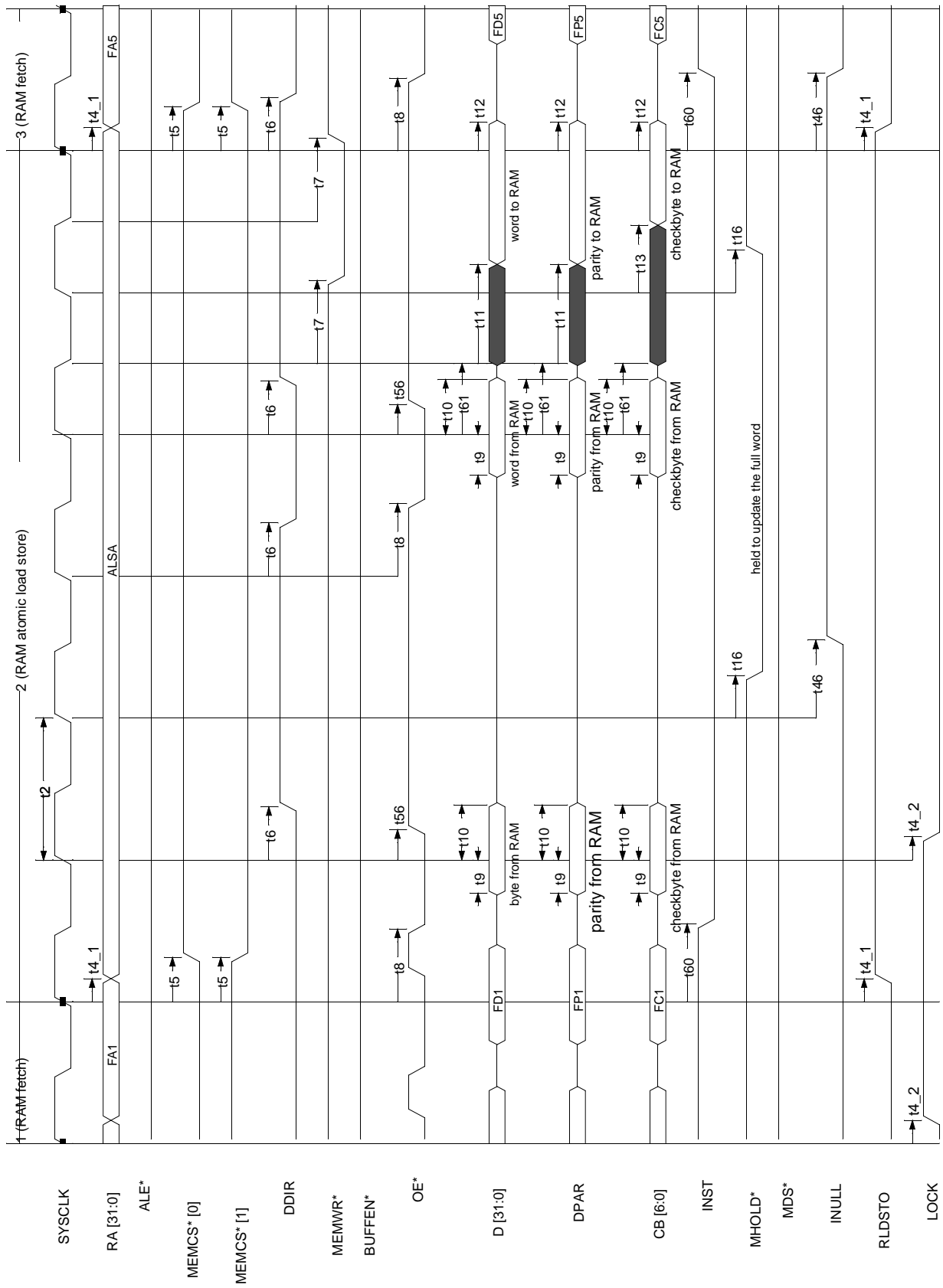

Figure 8. RAM Load-double and RAM Store-double Sequence - 0 Waitstate

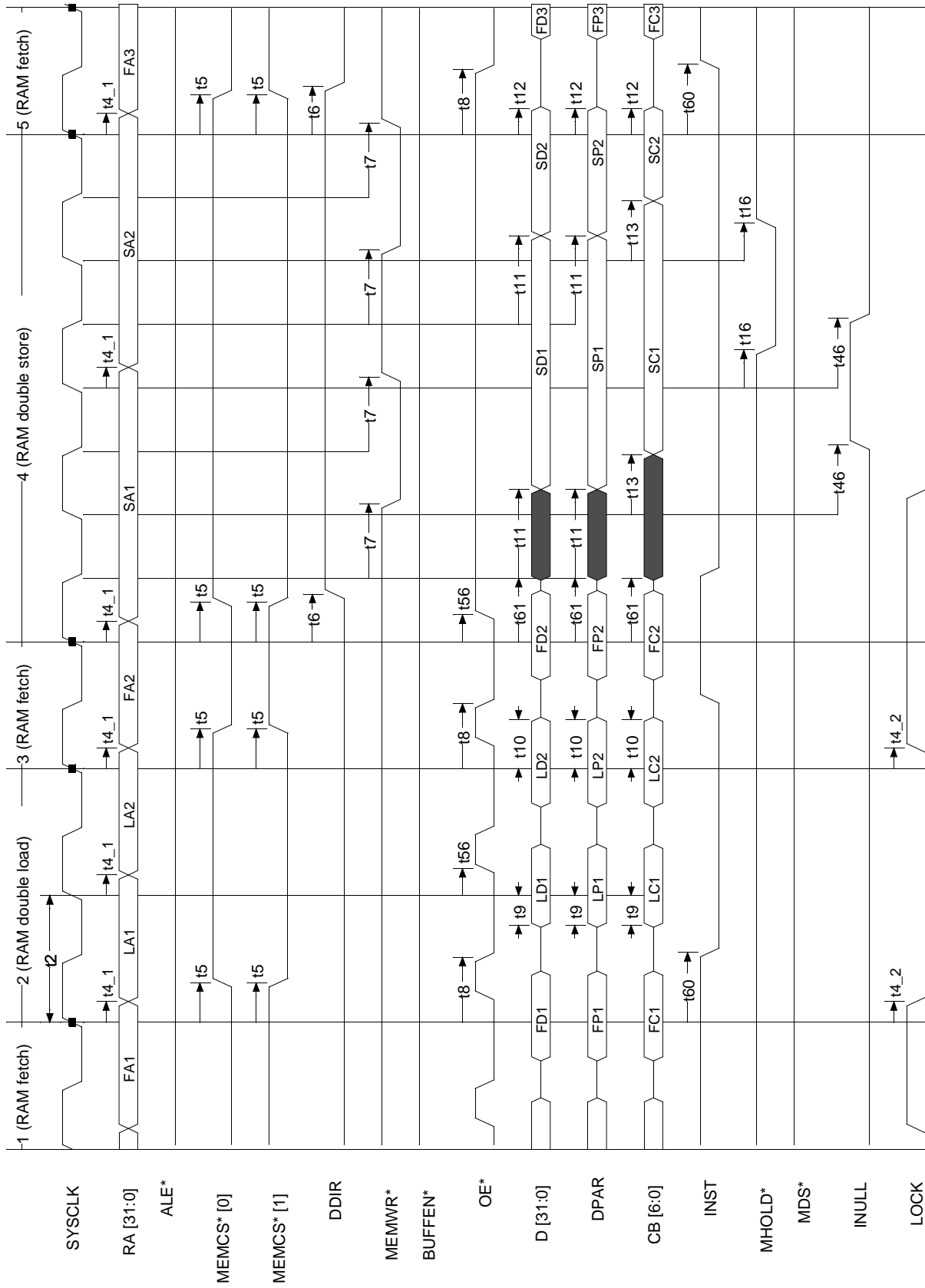

Figure 9. RAM Load with Correctable Error - 0 Waitstate

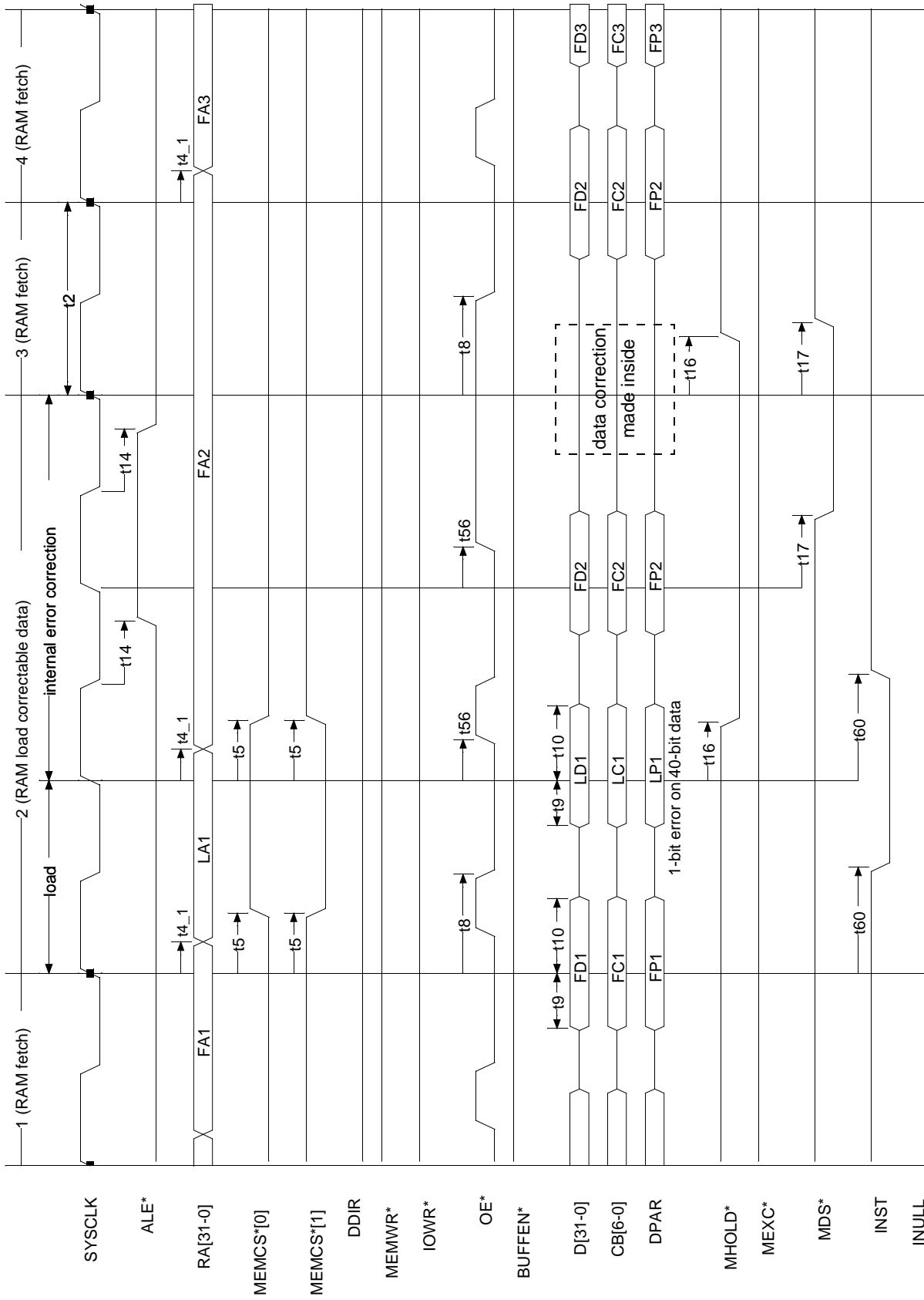

Figure 10. RAM Load with Uncorrectable Error - 0 Waitstate

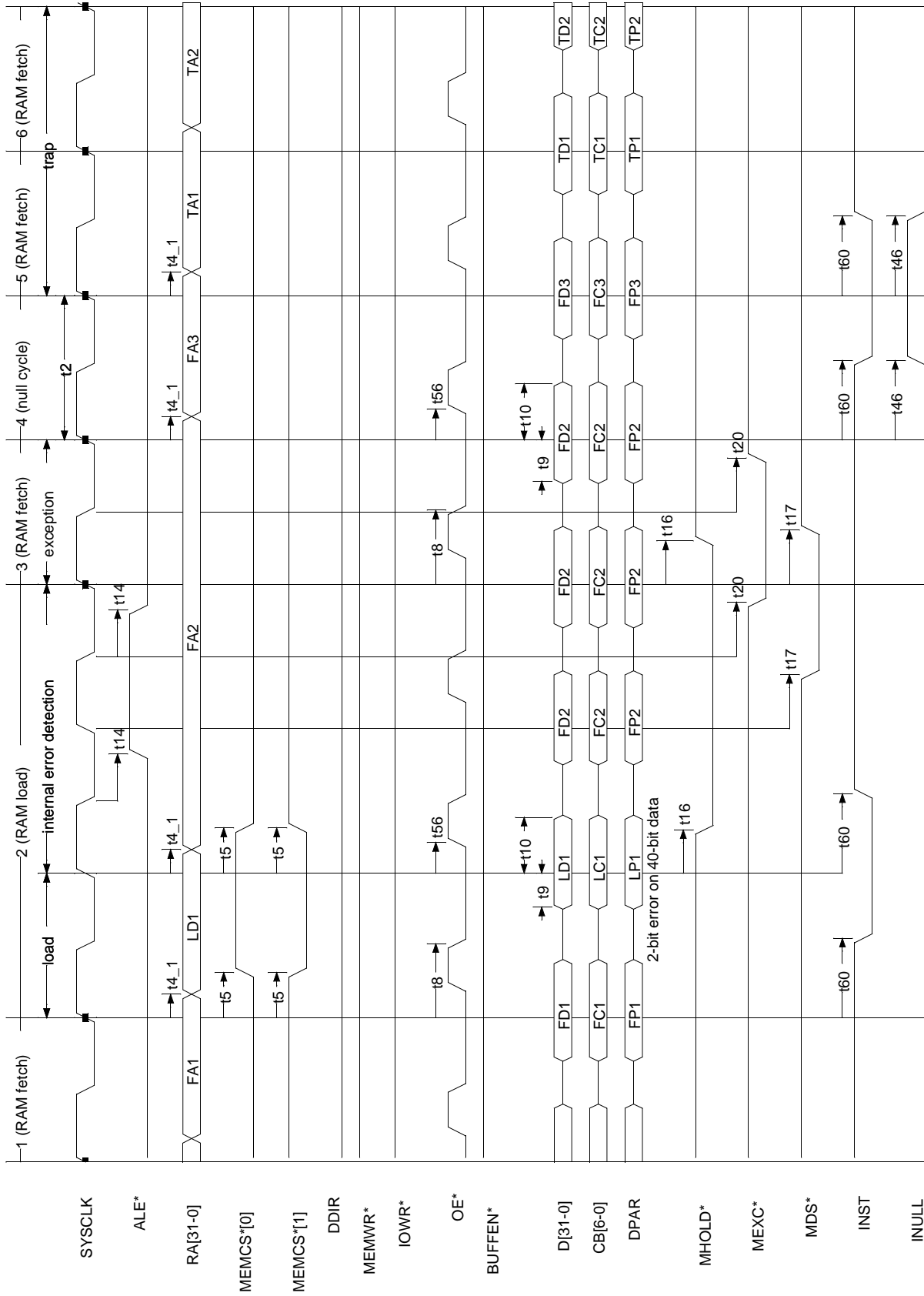

Figure 11. RAM Load with Unimplemented Area Access - 0 Waitstate

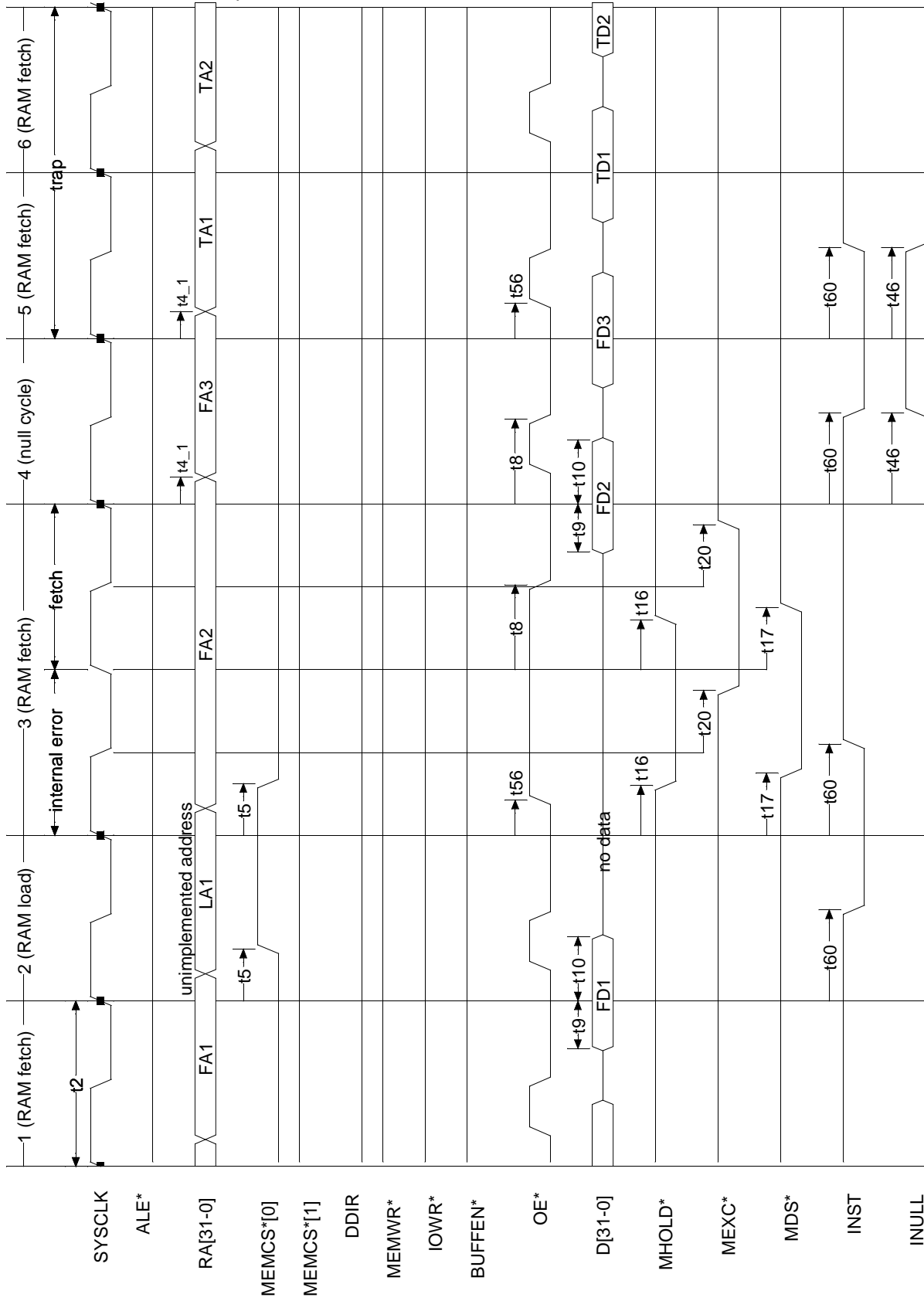

Figure 12. I/O Store Sequence with BUSRDY* and n Waitstates (Timing for 0 Waitstate = Timing for 1 Waitstates)

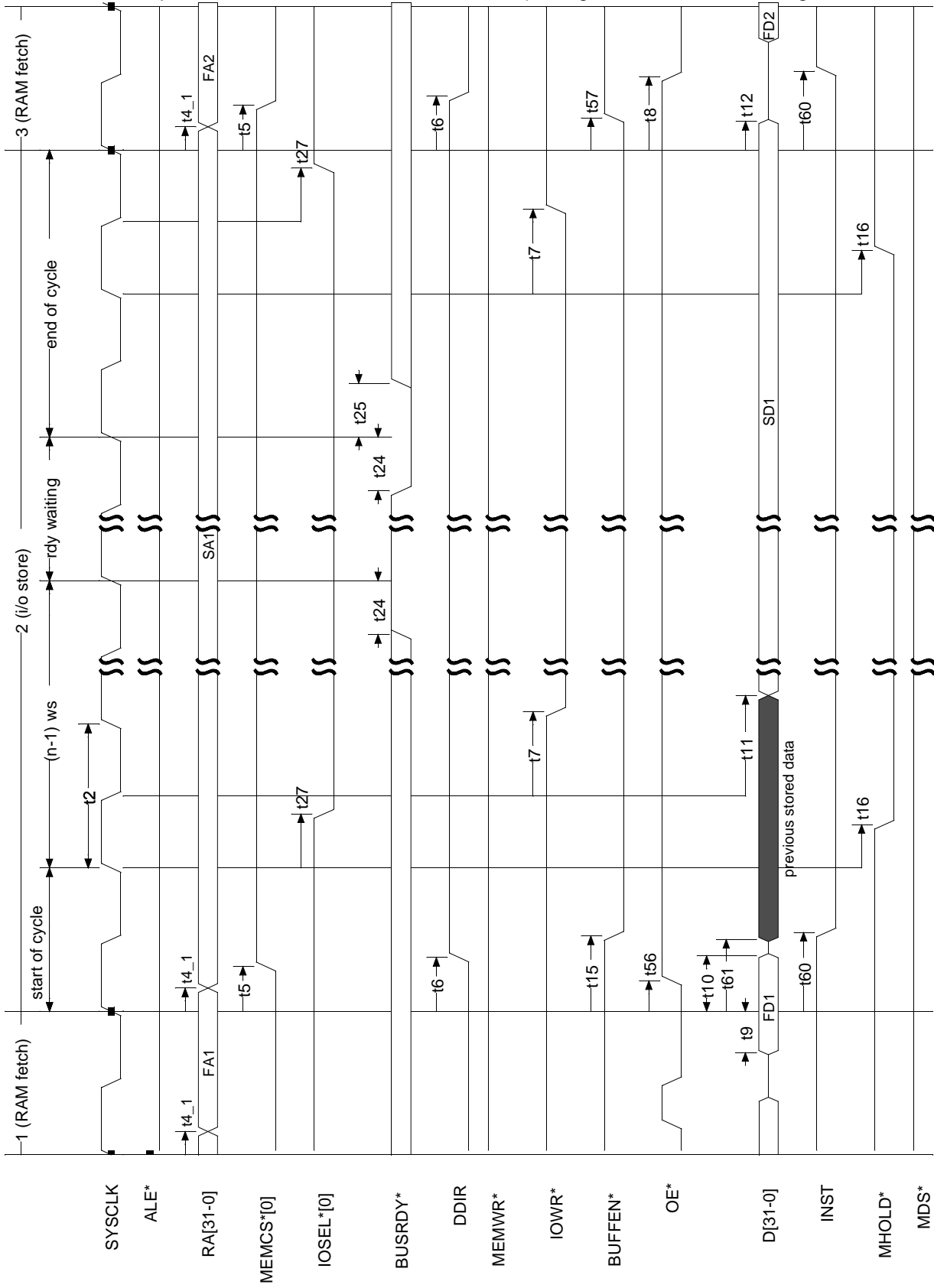

Figure 13. I/O Load Sequence with BUSRDY* and n Waitstates (Timing for 0 ws = Timing for 1 ws)

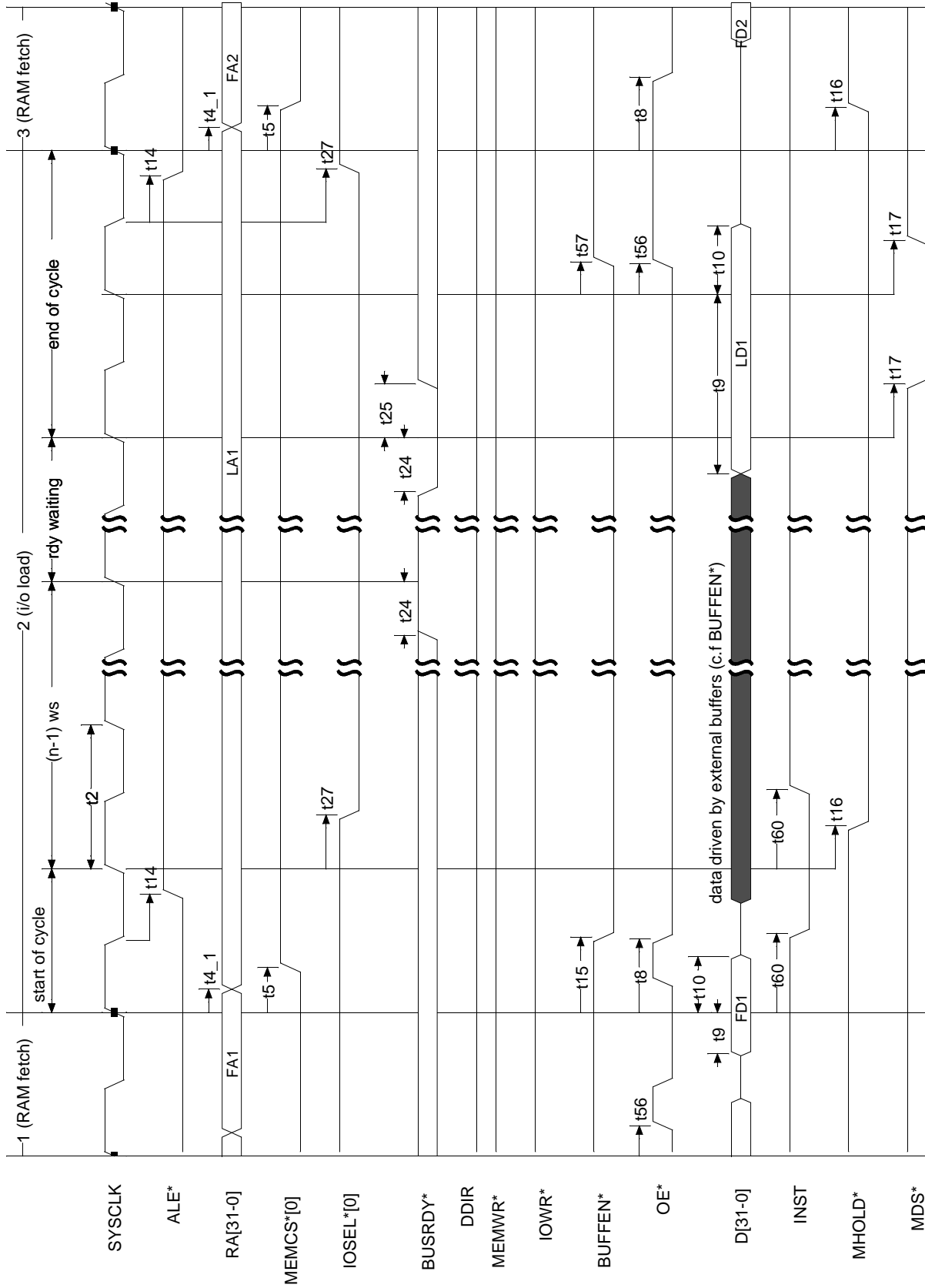

Figure 14. EXCHANGE RAM Store with BUSDRY* and n Waitstates

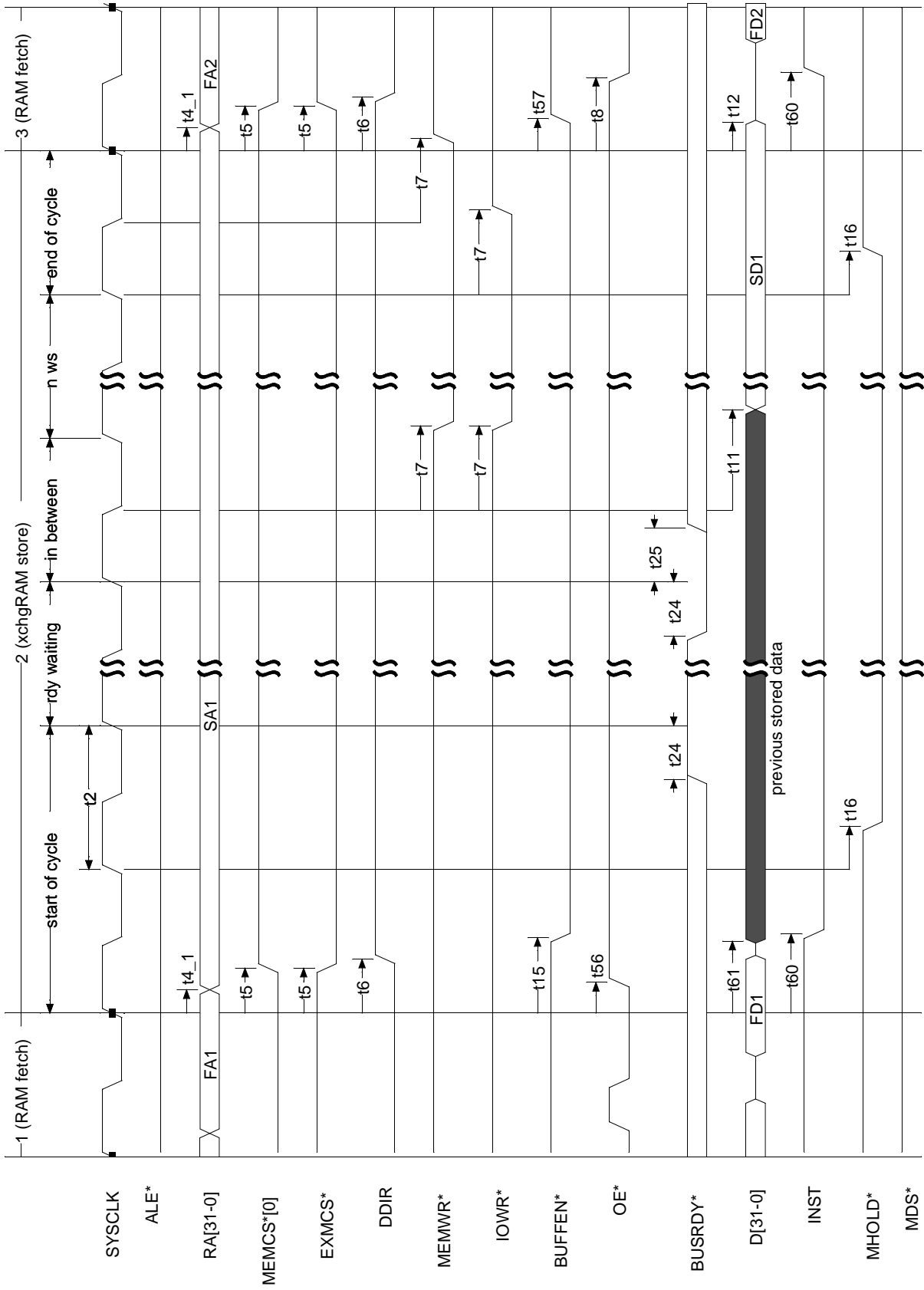

Figure 15. EXCHANGE RAM Load with BUSDRY* and n Waitstates

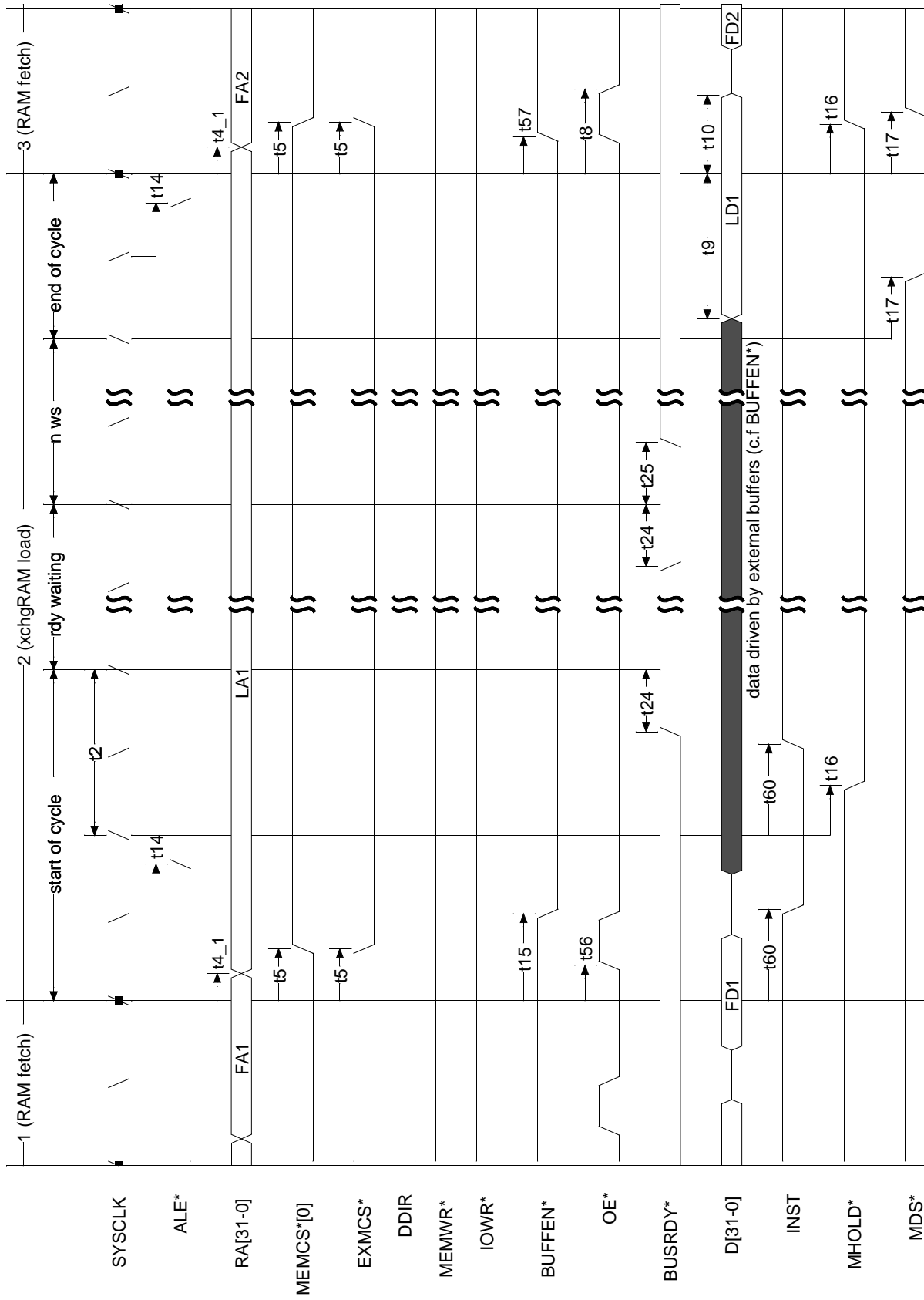

Figure 16. 8-bit BOOT PROM Fetch (or Load Word) - n Waitstates

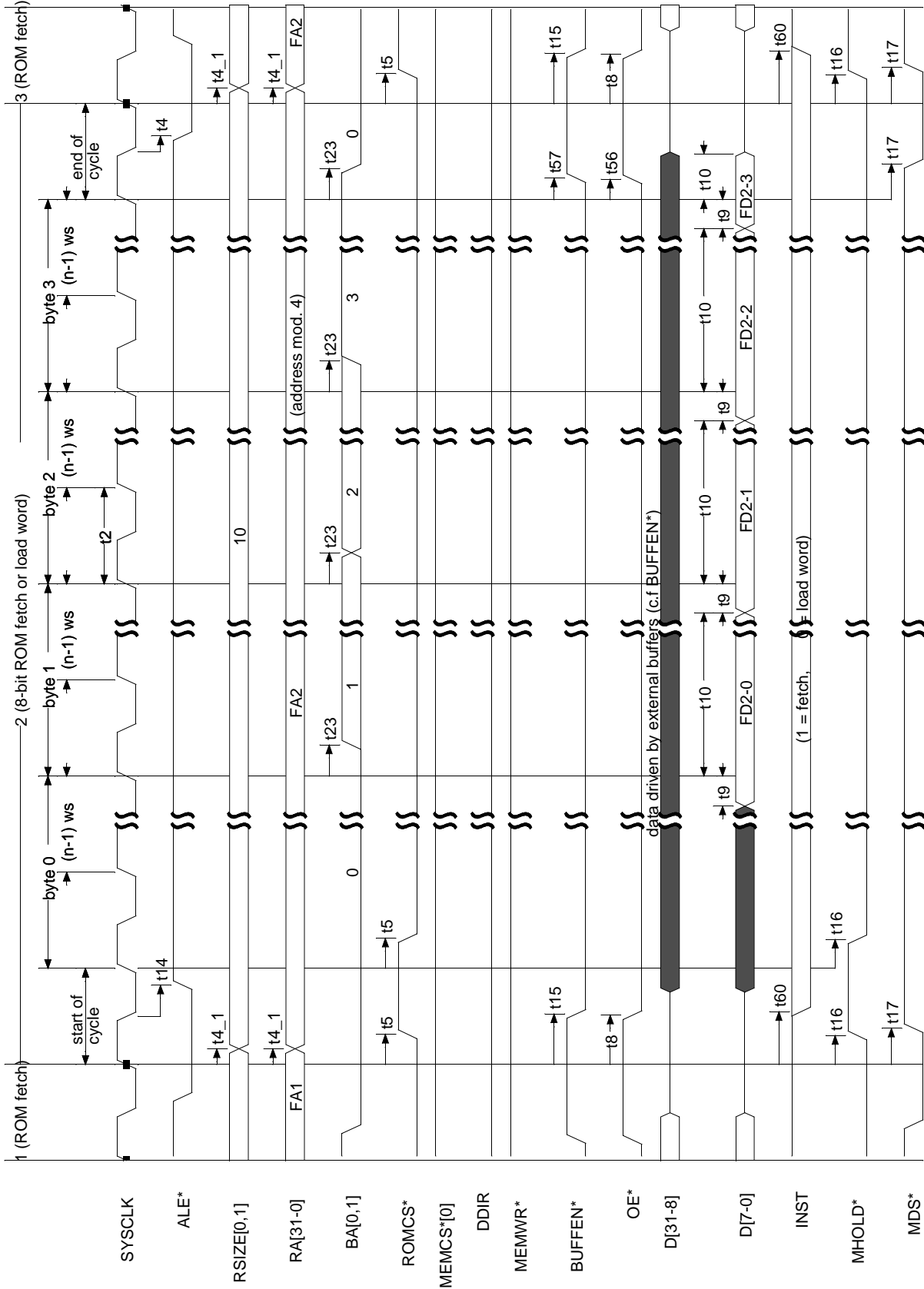

Figure 17. 8-bit BOOT PROM 2x Store byte - n Waitstate

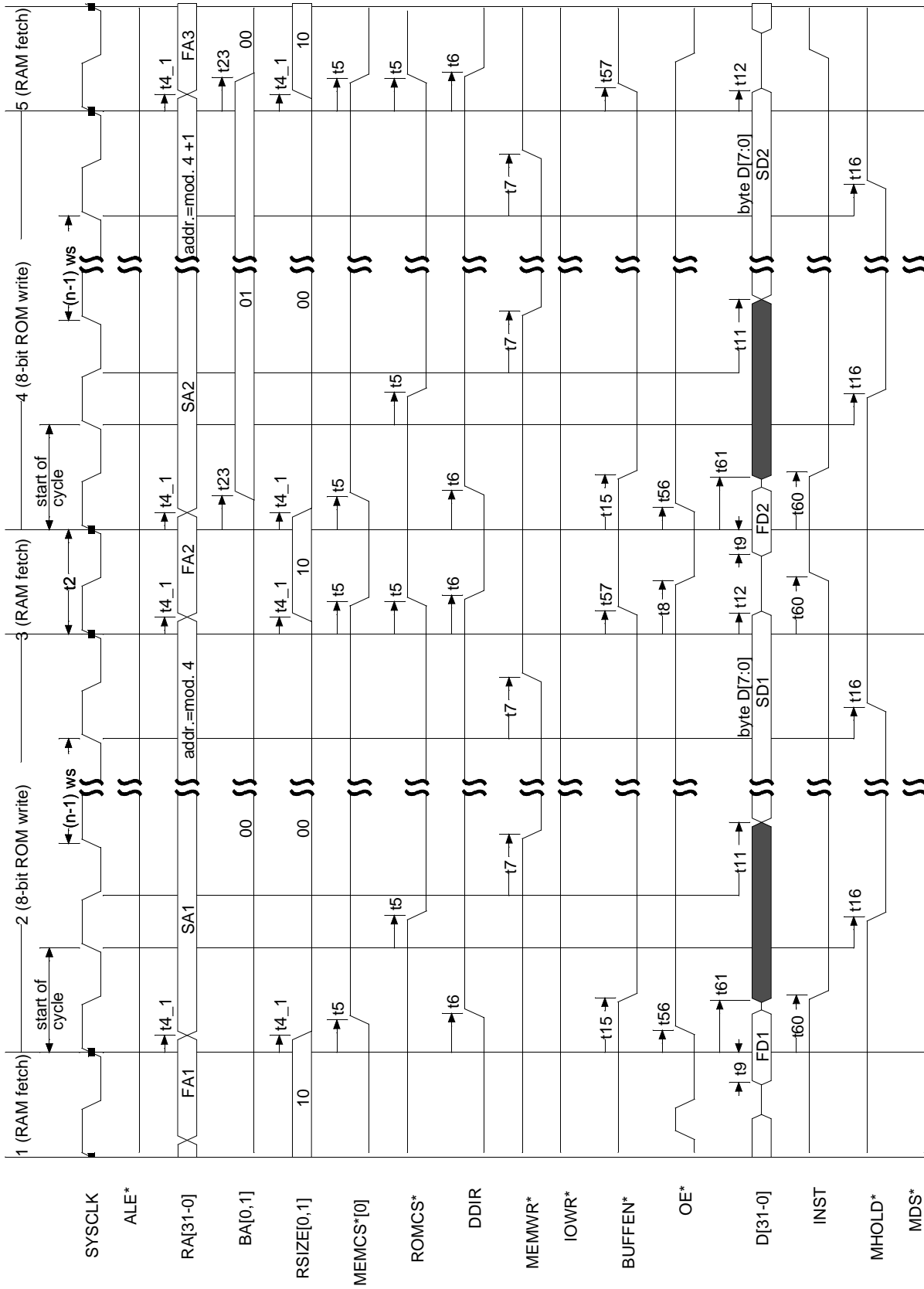

Figure 19. Edge Triggered Interrupt Timing

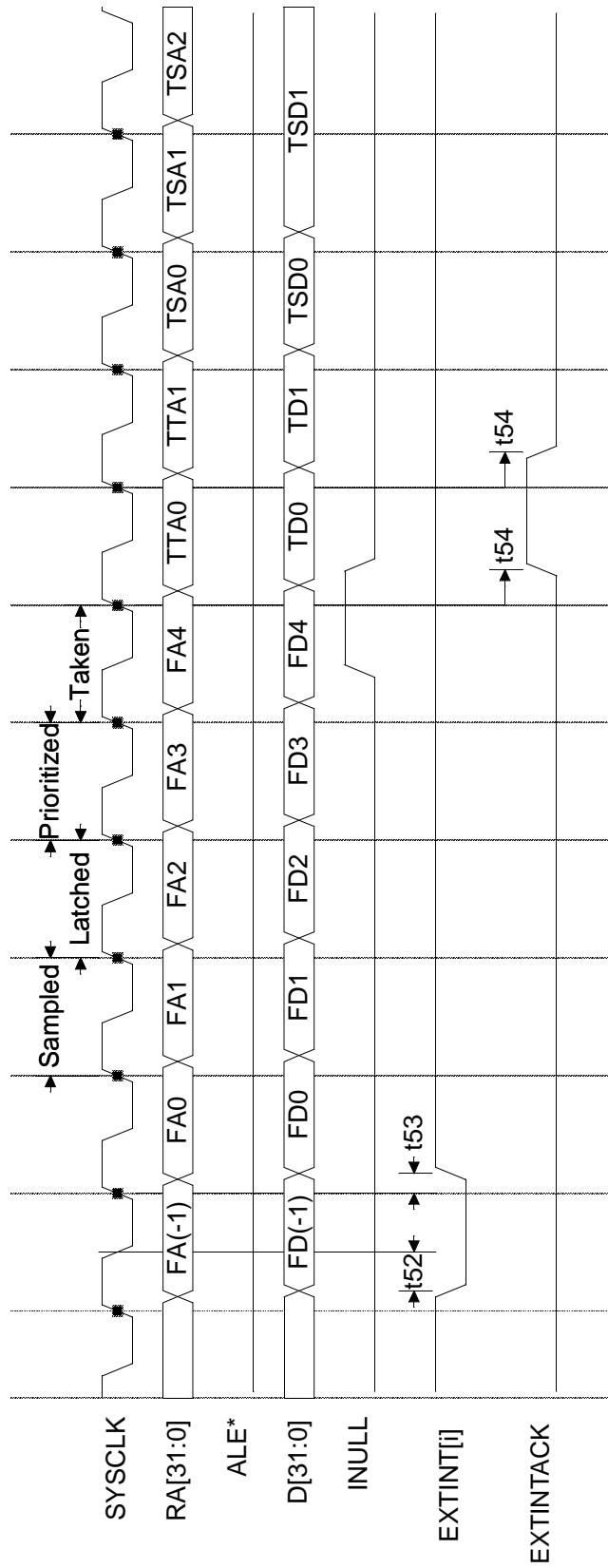

Figure 20. Halt Timing

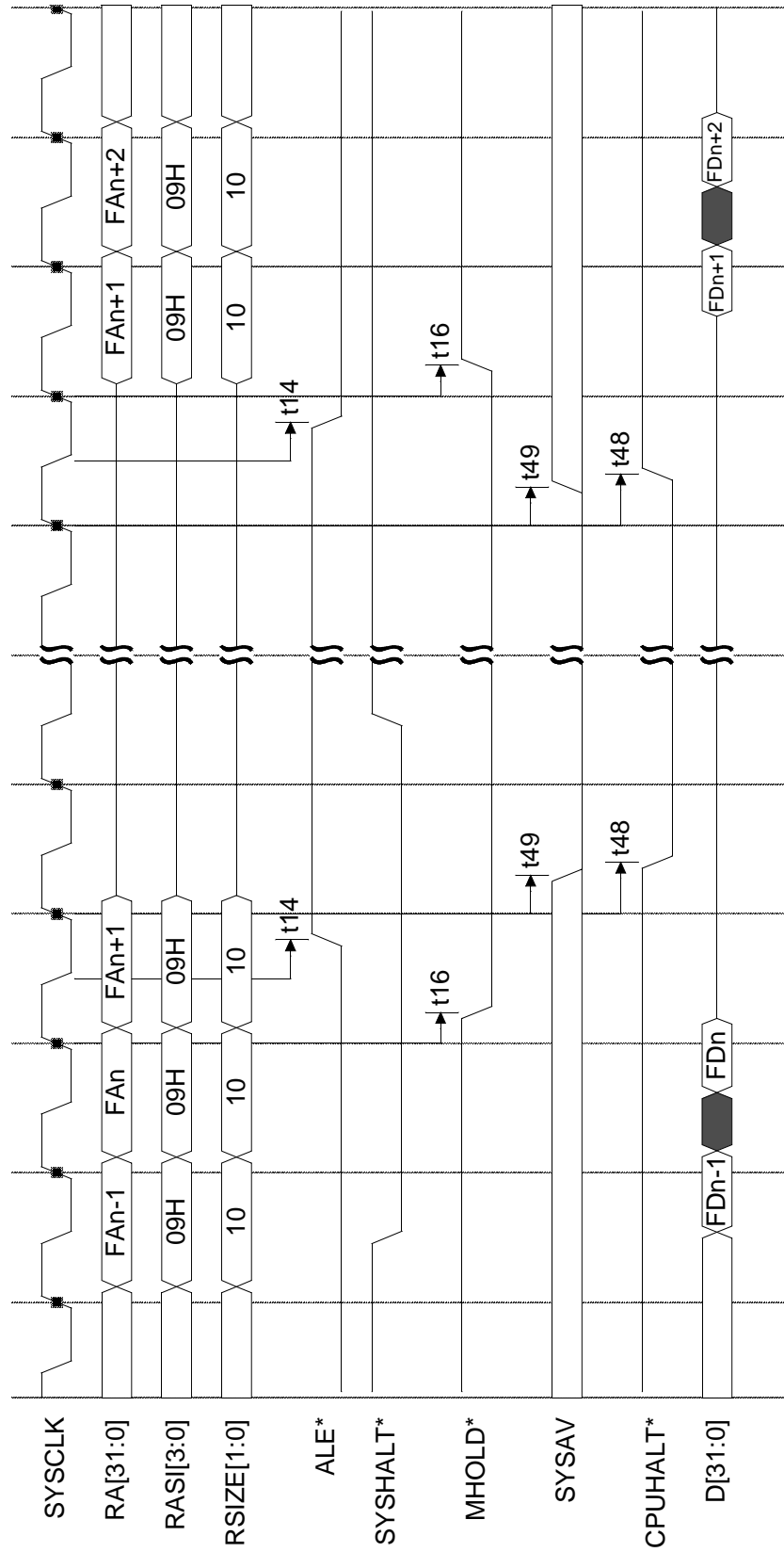

Figure 21. External Error with Halt Timing

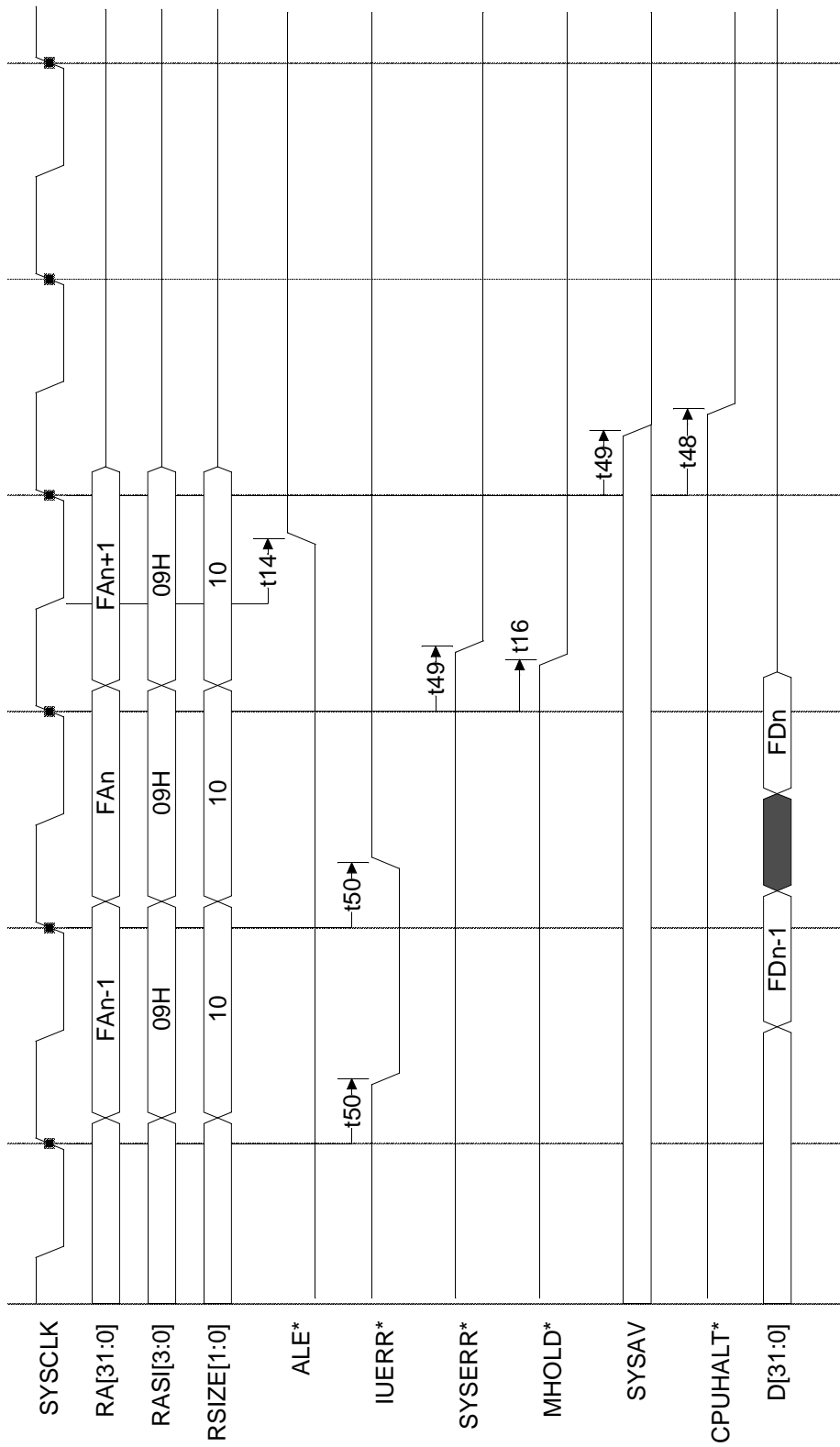
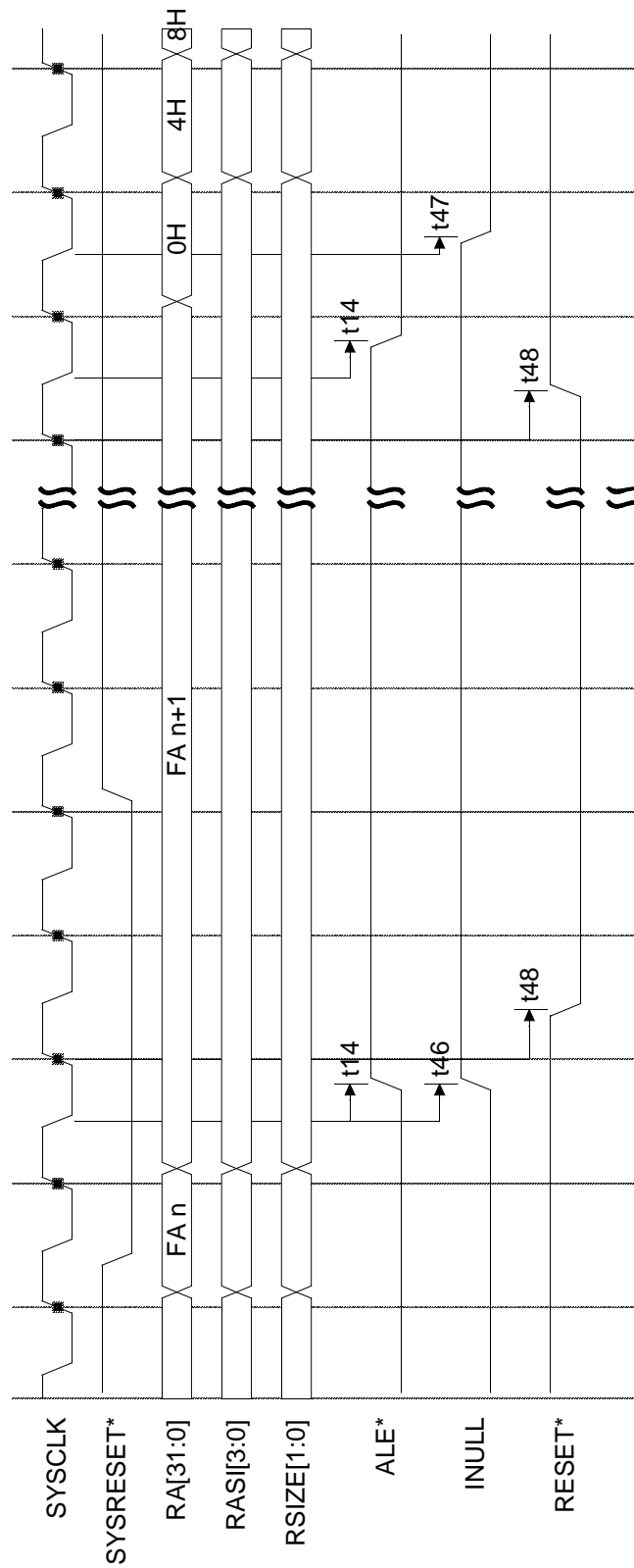

Figure 22. Reset Timing



Package Description

Thermal Characteristics

The thermal performance of a package is measured by its ability to dissipate the power required by the device into its surroundings. The electrical power drawn by the device generates heat on the top surface of the die. This heat is conducted through the package to the surface and then transferred when there is surrounding air by convection. Each heat transfer step has corresponding resistance, when there is surrounding air, to the heat flow, which is given the value $R\theta$, the thermal resistance coefficient. Subscripts are added to the coefficient to specify the two points that the heat is transferred between. Commonly used coefficients are $R\theta_{ja}$ (junction to ambient air), $R\theta_{jc}$ (junction to case) and $R\theta_{ca}$ (case to ambient).

An electrical analogy can be made, as shown in Figure 23, to illustrate the heat flow of a package. The heat transfer can be characterized mathematically by the following equation:

$$T_j - T_a = P \times R\theta_{ja}$$

- Where:
- P = Device operating power (Watts)
- T_j = Temperature of a junction on the device (°C)
- T_a = Temperature of the surrounding ambient air (°C)
- $R\theta_{ja} = R\theta_{jc} + R\theta_{ca}$ in °C/W

Figure 23. Thermal Model

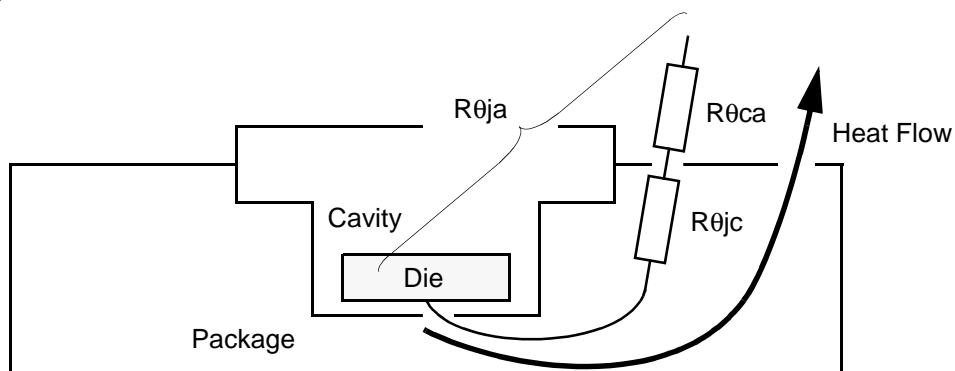
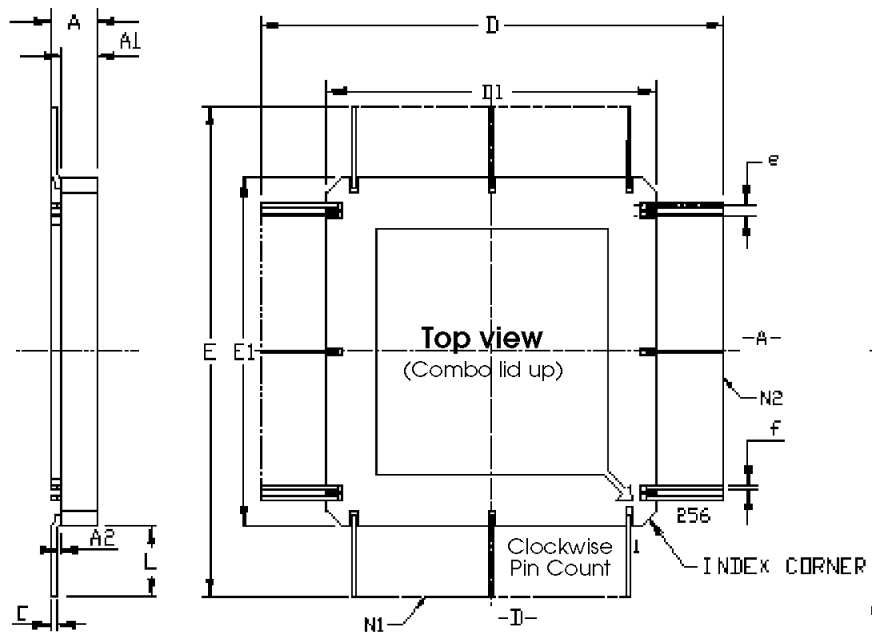

Table 8. Thermal Characteristics

Rθ -	Value	Unit	Conditions	
			Temperature	Air
ja	20 ~ 23	°C/W	25/90°C	Blown air
jc	0.4			
ja	31 ~ 41			Stationary air
jc	0.4			

256-lead MQFP-F Package



	mm		mils	
	Min	Max	Min	Max
A	2.41	3.18	.095	.125
C	0.10	0.20	.004	.008
D	53.23	55.74	2.095	2.195
D1	36.83	37.34	1.450	1.470
E	53.23	55.74	2.095	2.195
E1	36.83	37.34	1.450	1.470
e	0.508 BSC		.020 BSC	
f	0.15	0.25	.006	.010
A1	2.06	2.56	.081	.101
A2	0.05	0.36	.002	.014
L	8.20	9.20	.323	.362
N1	64		64	
N2	64		64	

256-lead MQFP-F Pin Assignments

Table 9. Pin Assignments

Pin	Signal	Pin	Signal	Pin	Signal	Pin	Signal
1	GPIINT	65	D[0]	129	RA[0]	193	DXFER
2	GPI[7]	66	RSIZE[1]	130	VCCO	194	$\overline{\text{MEXC}}$
3	VCCO	67	RSIZE[0]	131	VSSO	195	VCCO
4	VSSO	68	RASI[3]	132	RAPAR	196	VSSO
5	GPI[6]	69	VCCO	133	RASPAR	197	$\overline{\text{RESET}}$
6	GPI[5]	70	VSSO	134	DPAR	198	$\overline{\text{SYSRESET}}$
7	GPI[4]	71	RASI[2]	135	VCCO	199	BA[1]
8	GPI[3]	72	RASI[1]	136	VSSO	200	BA[0]
9	VCCO	73	RASI[0]	137	SYSCLK	201	CB[6]
10	VSSO	74	RA[31]	138	TDO	202	CB[5]
11	GPI[2]	75	RA[30]	139	$\overline{\text{TRST}}$	203	VCCO
12	GPI[1]	76	VCCO	140	TMS	204	VSSO
13	GPI[0]	77	VSSO	141	TDI	205	CB[4]
14	D[31]	78	RA[29]	142	TCK	206	CB[3]
15	D[30]	79	RA[28]	143	CLK2	207	CB[2]
16	VCCO	80	RA[27]	144	$\overline{\text{DRDY}}$	208	CB[1]
17	VSSO	81	VCCO	145	DMAAS	209	VCCO
18	D[29]	82	VSSO	146	VCCO	210	VSSO
19	D[28]	83	RA[26]	147	VSSO	211	CB[0]
20	VCCI	84	RA[25]	148	$\overline{\text{DMAGNT}}$	212	$\overline{\text{ALE}}$
21	VSSI	85	RA[24]	149	$\overline{\text{EXMCS}}$	213	VCCI
22	D[27]	86	VCCI	150	VCCI	214	VSSI
23	D[26]	87	VSSI	151	VSSI	215	$\overline{\text{PROM8}}$
24	VCCO	88	VCCO	152	$\overline{\text{DMAREQ}}$	216	$\overline{\text{ROMCS}}$
25	VSSO	89	VSSO	153	$\overline{\text{BUSERR}}$	217	$\overline{\text{MEMCS[9]}}$
26	D[25]	90	RA[23]	154	$\overline{\text{BUSRDY}}$	218	VCCO
27	D[24]	91	RA[22]	155	$\overline{\text{ROMWRT}}$	219	VSSO
28	D[23]	92	RA[21]	156	$\overline{\text{NOPAR}}$	220	$\overline{\text{MEMCS[8]}}$
29	D[22]	93	VCCO	157	$\overline{\text{SYSHALT}}$	221	$\overline{\text{MEMCS[7]}}$
30	VCCO	94	VSSO	158	$\overline{\text{CPUHALT}}$	222	$\overline{\text{MEMCS[6]}}$
31	VSSO	95	RA[20]	159	VCCO	223	$\overline{\text{MEMCS[5]}}$
32	D[21]	96	RA[19]	160	VSSO	224	$\overline{\text{MEMCS[4]}}$
33	D[20]	97	RA[18]	161	SYSERR	225	$\overline{\text{MEMCS[3]}}$
34	D[19]	98	VCCO	162	SYSAV	226	VCCO
35	D[18]	99	VSSO	163	EXTINT[4]	227	VSSO



Table 9. Pin Assignments (Continued)

Pin	Signal	Pin	Signal	Pin	Signal	Pin	Signal
36	VCCO	100	RA[17]	164	EXTINT[3]	228	$\overline{\text{MEMCS}}[2]$
37	VSSO	101	RA[16]	165	EXTINT[2]	229	$\overline{\text{MEMCS}}[1]$
38	D[17]	102	RA[15]	166	EXTINT[1]	230	$\overline{\text{MEMCS}}[0]$
39	D[16]	103	VCCO	167	EXTINT[0]	231	VCCI
40	VCCI	104	VSSO	168	VCCI	232	VSSI
41	VSSI	105	RA[14]	169	VSSI	233	$\overline{\text{OE}}$
42	D[15]	106	VCCI	170	EXTINTACK	234	VCCO
43	D[14]	107	VSSI	171	$\overline{\text{IUERR}}$	235	VSSO
44	VCCO	108	RA[13]	172	VCCO	236	$\overline{\text{MEMWR}}$
45	VSSO	109	RA[12]	173	VSSO	237	$\overline{\text{BUFFEN}}$
46	D[13]	110	VCCO	174	CPAR	238	DDIR
47	D[12]	111	VSSO	175	TXA	239	VCCO
48	D[11]	112	RA[11]	176	RXA	240	VSSO
49	D[10]	113	RA[10]	177	RXB	241	$\overline{\text{DDIR}}$
50	VCCO	114	RA[9]	178	TXB	242	$\overline{\text{MHOLD}}$
51	VSSO	115	VCCO	179	$\overline{\text{IOWR}}$	243	$\overline{\text{MDS}}$
52	D[9]	116	VSSO	180	$\overline{\text{IOSEL}}[3]$	244	WDCLK
53	D[8]	117	RA[8]	181	VCCO	245	IWDE
54	D[7]	118	RA[7]	182	VSSO	246	EWDINT
55	D[6]	119	RA[6]	183	$\overline{\text{IOSEL}}[2]$	247	TMODE[1]
56	VCCO	120	VCCO	184	$\overline{\text{IOSEL}}[1]$	248	TMODE[0]
57	VSSO	121	VSSO	185	$\overline{\text{IOSEL}}[0]$	249	DEBUG
58	D[5]	122	RA[5]	186	WRT	250	INULL
59	D[4]	123	RA[4]	187	$\overline{\text{WE}}$	251	DIA
60	D[3]	124	RA[3]	188	VCCO	252	VCCO
61	D[2]	125	VCCO	189	VSSO	253	VSSO
62	VCCO	126	VSSO	190	RD	254	FLUSH
63	VSSO	127	RA[2]	191	RLDSTO	255	INST
64	D[1]	128	RA[1]	192	LOCK	256	RTC

Ordering Information

Table 10. Possible Order Entries

Part-Number	Supply Voltage	Temperature Range	Maximum Speed (MHz)	Packaging	Quality Flow
TSC695F-25MA-E	5V	25°C	25	MQFP-F256	Engineering Samples
TSC695F-25MA	5V	-55° to +125°C	25	MQFP-F256	Standard Mil.
5962-0054001QXC	5V	-55° to +125°C	25	MQFP-F256	QML-Q
5962-0054001VXC	5V	-55° to +125°C	25	MQFP-F256	QML-V
TSC695F-25SASB	5V	-55° to +125°C	25	MQFP-F256	SCC B
TSC695F-25MB-E	5V	25°C	25	Die	Engineering Samples
5962-0054001Q9A	5V	-55° to +125°C	25	Die	QML-Q
5962-0054001V9A	5V	-55° to +125°C	25	Die	QML-V



Atmel Corporation

2325 Orchard Parkway
San Jose, CA 95131
Tel: 1(408) 441-0311
Fax: 1(408) 487-2600

Regional Headquarters

Europe

Atmel Sarl
Route des Arsenaux 41
Case Postale 80
CH-1705 Fribourg
Switzerland
Tel: (41) 26-426-5555
Fax: (41) 26-426-5500

Asia

Room 1219
Chinachem Golden Plaza
77 Mody Road Tsimshatsui
East Kowloon
Hong Kong
Tel: (852) 2721-9778
Fax: (852) 2722-1369

Japan

9F, Tonetsu Shinkawa Bldg.
1-24-8 Shinkawa
Chuo-ku, Tokyo 104-0033
Japan
Tel: (81) 3-3523-3551
Fax: (81) 3-3523-7581

Atmel Operations

Memory

2325 Orchard Parkway
San Jose, CA 95131
Tel: 1(408) 441-0311
Fax: 1(408) 436-4314

Microcontrollers

2325 Orchard Parkway
San Jose, CA 95131
Tel: 1(408) 441-0311
Fax: 1(408) 436-4314

La Chantrerie
BP 70602
44306 Nantes Cedex 3, France
Tel: (33) 2-40-18-18-18
Fax: (33) 2-40-18-19-60

ASIC/ASSP/Smart Cards

Zone Industrielle
13106 Rousset Cedex, France
Tel: (33) 4-42-53-60-00
Fax: (33) 4-42-53-60-01

1150 East Cheyenne Mtn. Blvd.
Colorado Springs, CO 80906
Tel: 1(719) 576-3300
Fax: 1(719) 540-1759

Scottish Enterprise Technology Park
Maxwell Building
East Kilbride G75 0QR, Scotland
Tel: (44) 1355-803-000
Fax: (44) 1355-242-743

RF/Automotive

Theresienstrasse 2
Postfach 3535
74025 Heilbronn, Germany
Tel: (49) 71-31-67-0
Fax: (49) 71-31-67-2340

1150 East Cheyenne Mtn. Blvd.
Colorado Springs, CO 80906
Tel: 1(719) 576-3300
Fax: 1(719) 540-1759

Biometrics/Imaging/Hi-Rel MPU/ High Speed Converters/RF Datacom

Avenue de Rochepleine
BP 123
38521 Saint-Egreve Cedex, France
Tel: (33) 4-76-58-30-00
Fax: (33) 4-76-58-34-80

e-mail

literature@atmel.com

Web Site

<http://www.atmel.com>

Disclaimer: Atmel Corporation makes no warranty for the use of its products, other than those expressly contained in the Company's standard warranty which is detailed in Atmel's Terms and Conditions located on the Company's web site. The Company assumes no responsibility for any errors which may appear in this document, reserves the right to change devices or specifications detailed herein at any time without notice, and does not make any commitment to update the information contained herein. No licenses to patents or other intellectual property of Atmel are granted by the Company in connection with the sale of Atmel products, expressly or by implication. Atmel's products are not authorized for use as critical components in life support devices or systems.

© Atmel Corporation 2003. All rights reserved. Atmel® and combinations thereof are the registered trademarks of Atmel Corporation or its subsidiaries. Other terms and product names may be the trademarks of others.



Printed on recycled paper.