



General Description

The AAT3689 BatteryManager is a highly integrated single cell lithium-ion/polymer battery charger IC designed to operate with USB port and AC adapter inputs. It requires a minimum number of external components.

The AAT3689 precisely regulates battery charge voltage and current for 4.2V lithium-ion/polymer battery cells. Adapter charge current rates may be programmed up to 1.0A. In the absence of an adapter and with a USB port connected, the battery can also be charged by USB power. The USB charge current can be programmed up to 500mA. USB charging is disabled when an adapter is present.

Battery temperature and charge state are fully monitored for fault conditions. In the event of an over-voltage or over-temperature failure, the device will automatically shut down, thus protecting the charging device, control system, and the battery under charge. Status monitor output pins are provided to indicate the battery charge status by directly driving two external LEDs.

The AAT3689 is available in a Pb-free, thermally-enhanced, space-saving 12-pin 3x3mm TDFN package and is rated over the -40°C to +85°C temperature range.

Features

- USB/AC Adapter System Power Charger
 - USB: Programmable up to 500mA
 - Adapter: Programmable up to 1.0A
- 4.0V to 5.5V Input Voltage Range
- Adapter Presence Automatically Disables USB Charging
- High Level of Integration With Internal:
 - Charging Devices
 - Reverse Blocking Diodes
 - Current Sensing
- Automatic Recharge Sequencing
- Battery Temperature Monitoring
- Full Battery Charge Auto Turn-Off
- Over-Current Protection
- Over-Voltage Protection
- Emergency Thermal Protection
- Power On Reset and Soft Start
- 12-Pin 3x3 TDFN Package

Applications

- Cellular Telephones
- Digital Still Cameras
- Hand-Held PCs
- MP3 Players
- Personal Data Assistants (PDAs)
- Other Lithium-Ion/Polymer Battery-Powered Devices

Typical Application

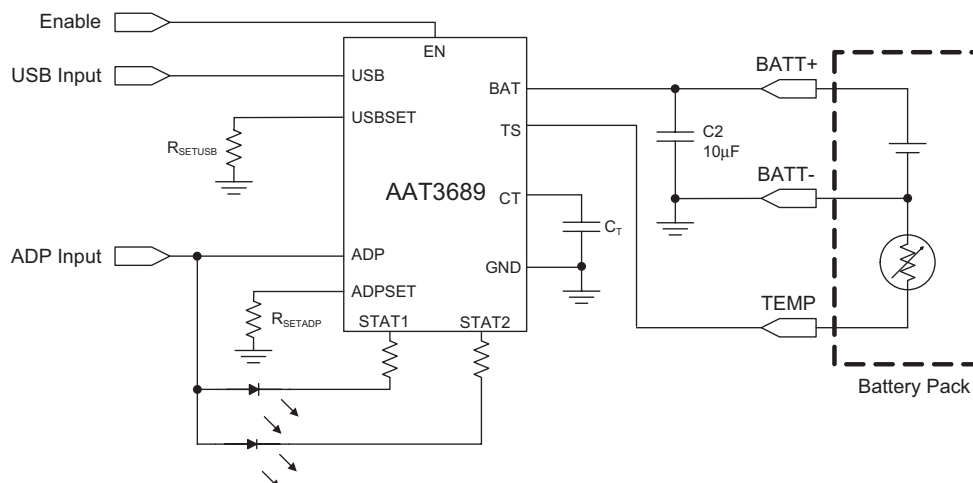

Pin Descriptions

Pin #	Name	Type	Function
1, 10	USB	In	USB power supply input.
2	BAT	In/Out	Battery charging and sensing.
3	ADP	In	Adapter power supply input.
4	GND	Ground	Ground connection.
5	EN	In	Enable pin. Logic high enables the IC.
6	TS	In/Out	Connect to 10kΩ NTC thermistor.
7	STAT2	Out	Battery charge status indicator pin to drive an LED: active low, open-drain.
8	STAT1	Out	Battery charge status indicator pin to drive an LED: active low, open-drain.
9	CT	In/Out	Timing capacitor to adjust internal watchdog timer. Set maximum charge time for adapter powered trickle, CC, and CV charge modes. The watchdog timer only sets the timers for adapter battery charging; there is no timeout for the battery charging from the USB input. If timing function is not needed, terminate this pin to ground.
11	USBSET	In/Out	Connect a resistor between this pin and GND to set the USB charging current.
12	ADPSET	In/Out	Connect a resistor between this pin and GND to set the adapter charging current.
EP			Exposed paddle (bottom); connect to GND directly beneath package.

Pin Configuration

TDFN33-12
(Top View)

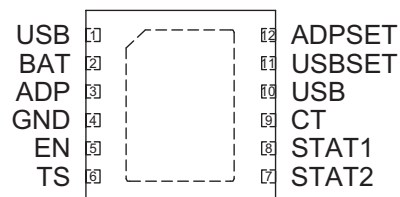

Absolute Maximum Ratings¹

Symbol	Description	Value	Units
V_P	USB, ADP, <30ms, Duty Cycle <10%	-0.3 to 7.0	V
V_P	USB, ADP Continuous	-0.3 to 6.0	V
V_N	BAT, USBSET, ADPSET, STAT1, STAT2, TS, CT, EN	-0.3 to $V_P + 0.3$	V
T_J	Operating Junction Temperature Range	-40 to 150	°C
T_{LEAD}	Maximum Soldering Temperature (at leads)	300	°C

Thermal Information²

Symbol	Description	Value	Units
θ_{JA}	Maximum Thermal Resistance	50	°C/W
P_D	Maximum Power Dissipation	2.0	W

1. Stresses above those listed in Absolute Maximum Ratings may cause permanent damage to the device. Functional operation at conditions other than the operating conditions specified is not implied. Only one Absolute Maximum Rating should be applied at any one time.
2. Mounted on an FR4 board.

Electrical Characteristics¹

$V_{ADP} = 5V$, $T_A = -25^{\circ}C$ to $+85^{\circ}C$, unless otherwise noted. Typical values are $T_A = 25^{\circ}C$.

Symbol	Description	Conditions	Min	Typ	Max	Units
Operation						
V_{USB}, V_{ADP}	USB Port or Adapter Voltage Range		4.0		5.5	V
V_{U-DSBL}	ADP Voltage Level to Disable USB Charging		4.25	4.5	4.7	V
V_{UVLO}	Under-Voltage Lockout	Rising Edge		3.0		V
	Under-Voltage Lockout Hysteresis			150		mV
I_{OP}	Operating Current	CC Charge Current = 500mA		0.75	1.5	mA
I_{SLEEP}	Sleep Mode Current	$V_{ADP} = 5V, USB = EN = GND$		0.3	1	μA
		$V_{USB} = 5V, ADP = EN = GND$			12	
$I_{Leakage}$	Reverse Leakage Current from BAT Pin	$V_{BAT} = 4V, USB, ADP$ Pins Open		1.0		μA
Voltage Regulation						
$V_{BAT_EOC}^1$	End of Charge Voltage Accuracy		4.158	4.2	4.242	V
$\Delta V_{BAT}/V_{BAT}$	EOC Voltage Tolerance			0.5		%
V_{MIN}	Preconditioning Voltage Threshold		2.8	3.0	3.15	V
V_{RCH}	Battery Recharge Voltage Threshold			$V_{BAT_EOC} - 0.1$		V
Current Regulation						
I_{CH}	Charge Current		100		1000	mA
$\Delta I_{CH}/I_{CH}$	Charge Current Regulation Tolerance			10		%
V_{ADPSET}	ADPSET Pin Voltage	In CC Mode		2.0		V
V_{USBSET}	USBSET Pin Voltage	In CC Mode		2.0		V
K_{IADP}	Current Set Factor: I_{CHARGE}/I_{ADPSET}			4000		
K_{IUSB}	Current Set Factor: I_{CHARGE}/I_{USBSET}			2000		
Charging Devices						
$R_{DS(ON)A}$	Adapter Charging Transistor On Resistance	$V_{IN} = 5.5V$	0.2	0.25	0.35	Ω
$R_{DS(ON)U}$	USB Charging Transistor On Resistance	$V_{IN} = 5.5V$	0.4	0.5	0.65	Ω

1. The AAT3689 output charge voltage is specified over the 0° to $70^{\circ}C$ ambient temperature range; operation over the $-25^{\circ}C$ to $+85^{\circ}C$ temperature range is guaranteed by design.

Electrical Characteristics¹

$V_{ADP} = 5V$, $T_A = -25^{\circ}C$ to $+85^{\circ}C$, unless otherwise noted. Typical values are $T_A = 25^{\circ}C$.

Symbol	Description	Conditions	Min	Typ	Max	Units
Logic Control / Protection						
$V_{EN(H)}$	Input High Threshold (Adapter)		1.6			V
	Input High Threshold (USB)		2.2			
$V_{EN(L)}$	Input Low Threshold				0.4	V
$I_{EN(H)}$	EN Input Current	$V_{EN} = 5V$			10	μA
T_P	Preconditioning Time Out (ADP mode only)	$C_{CT} = 100nF$, $V_{ADP} = 5.5V$		25		Minute
T_C	Preconditioning and Constant Current Mode Time Out (ADP mode only)	$C_{CT} = 100nF$, $V_{ADP} = 5.5V$		3.0		Hour
T_V	Constant Voltage Mode Time Out (ADP mode only)	$C_{CT} = 100nF$, $V_{ADP} = 5.5V$		3.0		Hour
V_{STAT}	Output Low Voltage	STAT Pin Sinks 4mA			0.4	V
I_{STAT}	STAT Pin Current Sink Capability			8.0		mA
V_{OVP}	Over-Voltage Protection Threshold			4.4		V
I_{TK}/I_{CH}	Pre-Charge Current			10		%
I_{OCP}	Over-Current Protection Threshold			105		% I_{CHG_CC}
I_{TERM}/I_{CHG}	Charge Termination Threshold Current			7.5		%
I_{TS}	Current Source from TS Pin		70	80	90	μA
TS1	TS Hot Temperature Fault	Threshold	310	330	350	mV
		Hysteresis		15		
TS2	TS Cold Temperature Fault	Threshold	2.2	2.3	2.4	V
		Hysteresis		10		
T_{OVSD}	Over-Temperature Shutdown Threshold			145		$^{\circ}C$

1. The AAT3689 output charge voltage is specified over the 0° to $70^{\circ}C$ ambient temperature range; operation over the $-25^{\circ}C$ to $+85^{\circ}C$ temperature range is guaranteed by design.

Typical Characteristics

$I_{FASTCHARGE}$ vs. R_{SET}

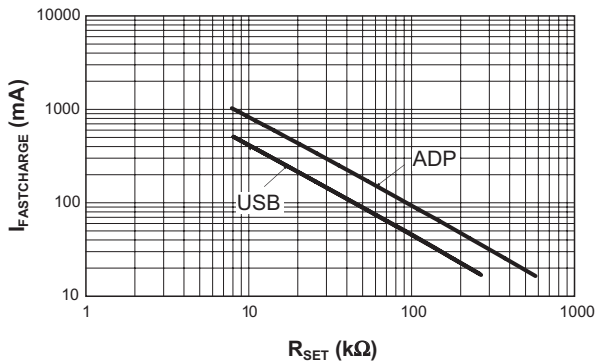

Battery Voltage vs. Supply Voltage

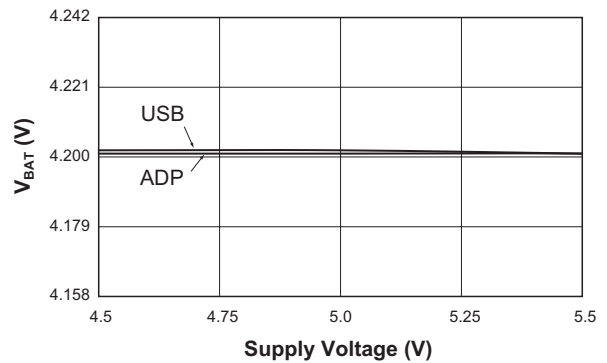

Battery Recharge Voltage Threshold vs. Temperature

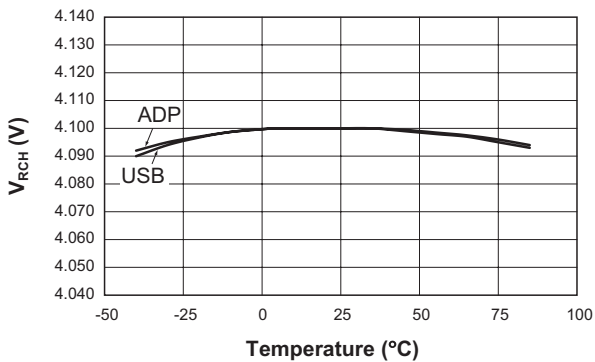

End of Charge Voltage vs. Temperature

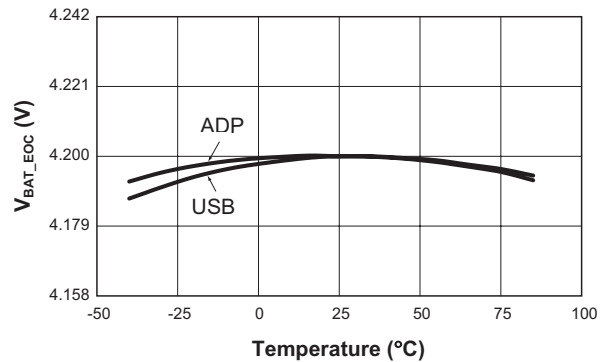

Preconditioning Voltage Threshold vs. Temperature

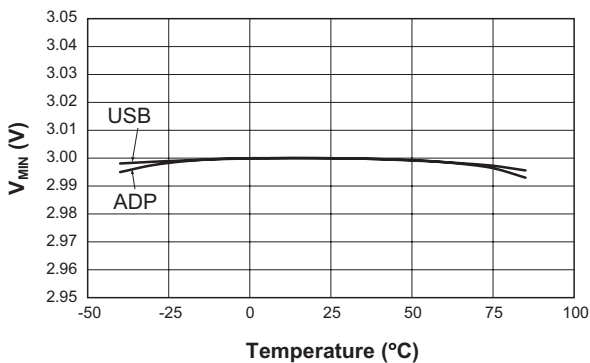

Preconditioning Charge Current vs. Temperature
($R_{SETADP} = 8.06k\Omega$; $R_{SETUSB} = 8.06k\Omega$)

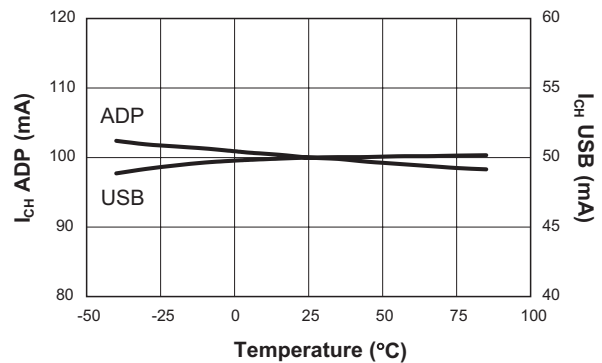

Typical Characteristics

Fast Charge Current vs. Temperature
($R_{SETADP} = 8.06k\Omega$; $R_{SETUSB} = 8.06k\Omega$)

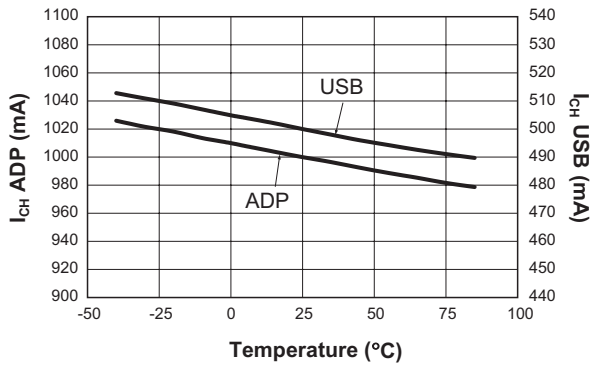

Adapter Charging Current vs. Battery Voltage
($R_{SETADP} = 8.06k\Omega$)

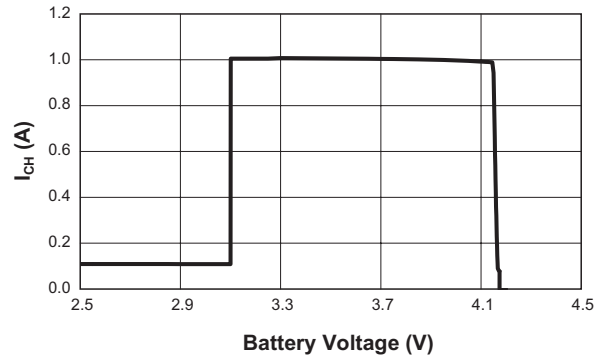

USB Charging Current vs. Battery Voltage
($R_{SETUSB} = 8.06k\Omega$)

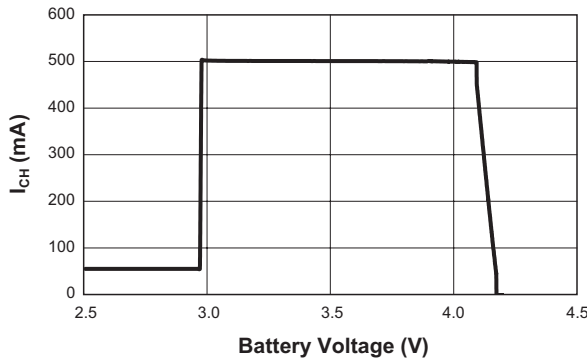

Fast Charge Current vs. Adapter Supply Voltage
($R_{SETADP} = 8.06k\Omega$)

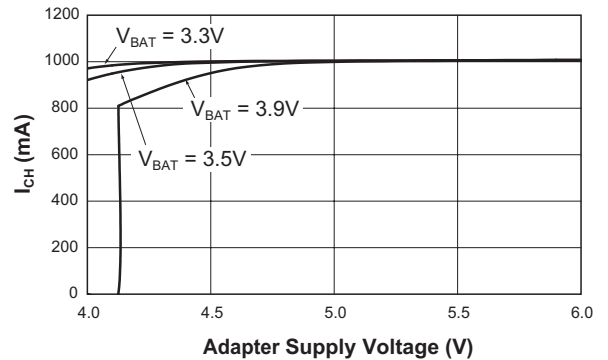

Fast Charge Current vs. USB Supply Voltage
($R_{SETUSB} = 8.06k\Omega$)

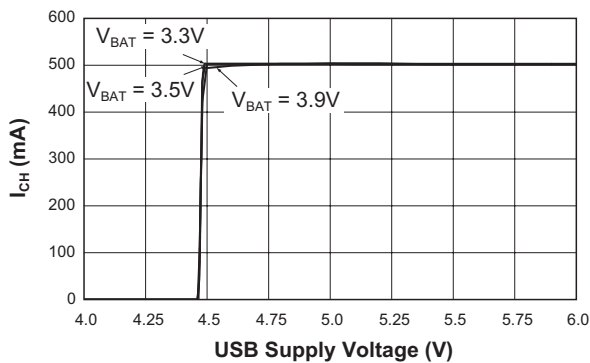

Fast Charge Current vs. USB Supply Voltage
($R_{SETUSB} = 42.4k\Omega$)

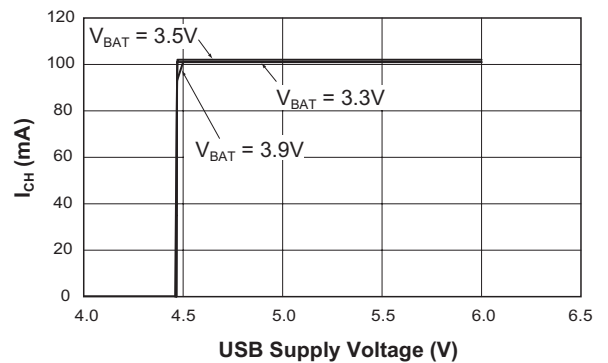

Typical Characteristics

Fast Charge Current vs. USB Supply Voltage
($R_{SETUSB} = 8.06k\Omega$)

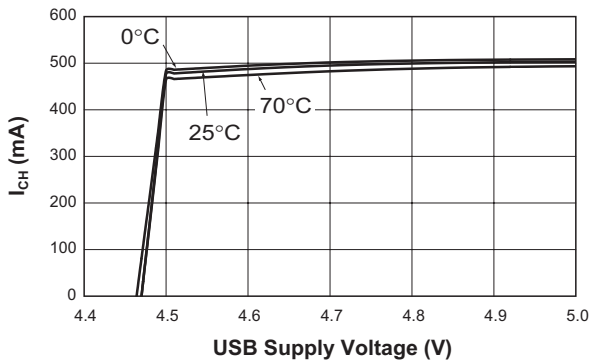

V_{IH} vs. Supply Voltage
EN Pin (Rising)

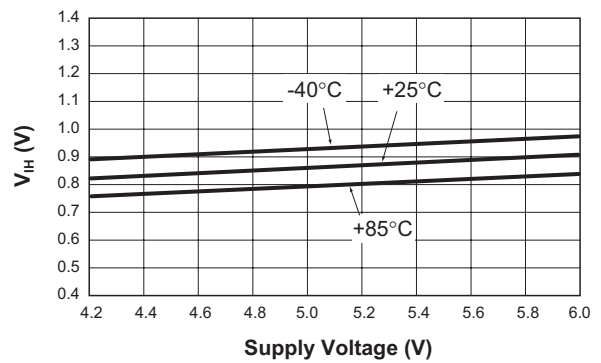

V_{IL} vs. Supply Voltage
EN Pin (Falling)

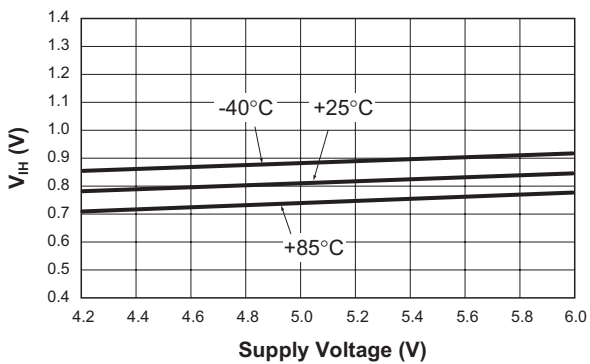

Adapter Mode Supply Current vs. ADPSET Resistor

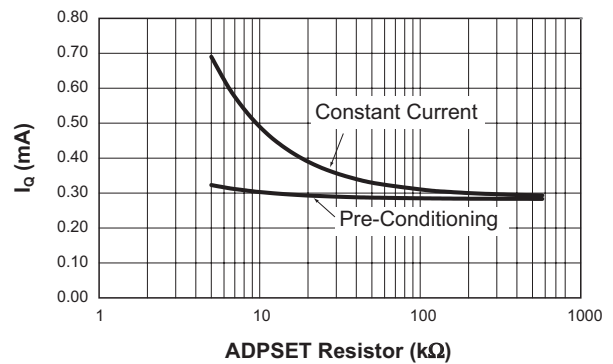

Counter Timeout vs. Temperature
($C_T = 0.1\mu F$)

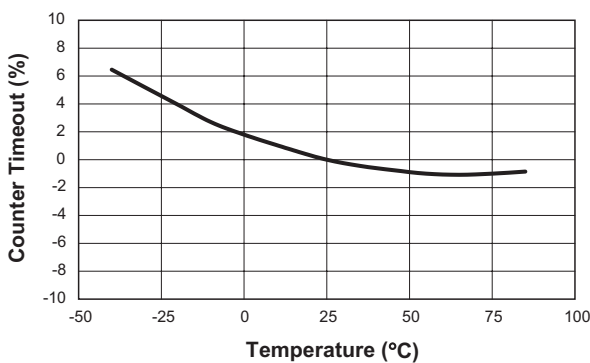

CT Pin Capacitance vs. Counter Timeout

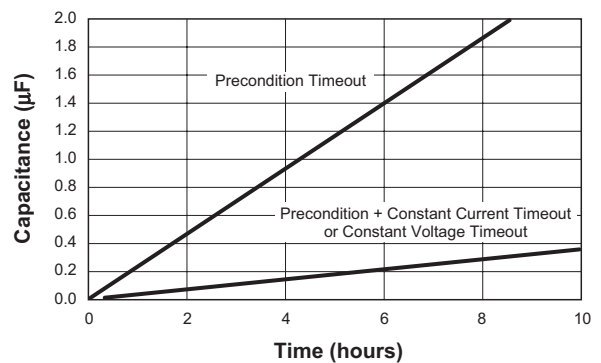

Typical Characteristics

Temperature Sense Output Current
vs. Temperature

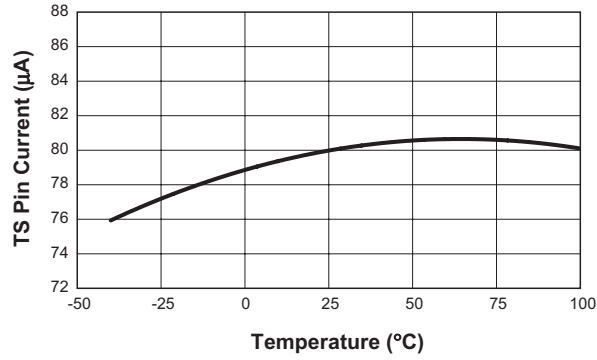

Functional Block Diagram

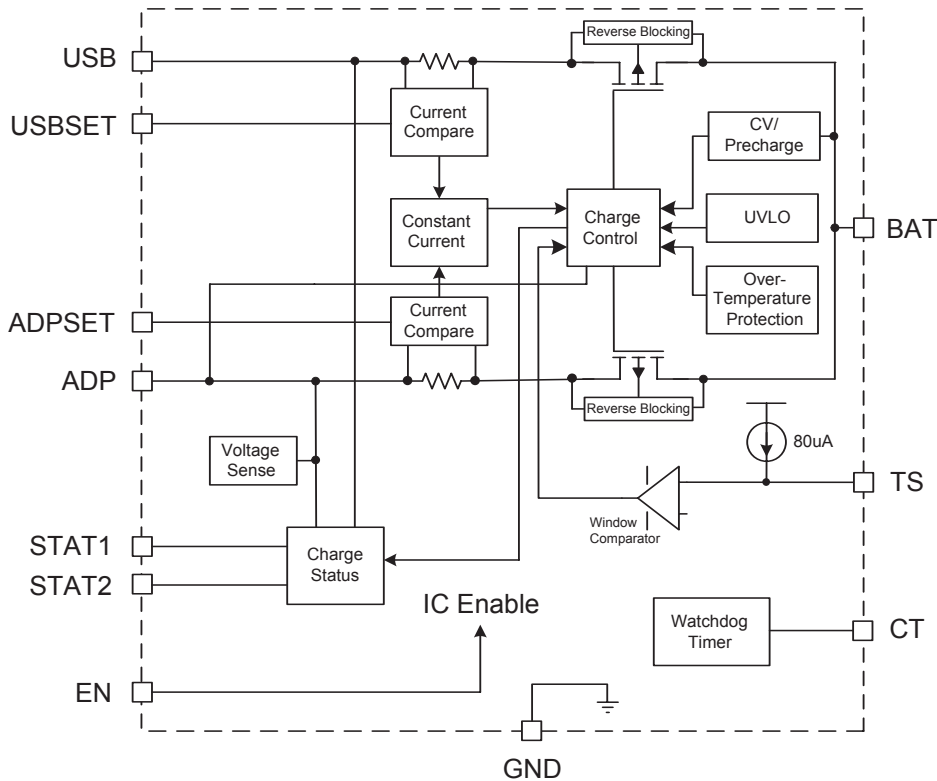

Functional Description

The AAT3689 is a highly integrated single cell lithium-ion/polymer battery charger IC designed to operate with USB port and AC adapter inputs, while requiring a minimum number of external components. The AAT3689 precisely regulates battery charge voltage and current for 4.2V lithium-ion/polymer battery cells.

The adapter charge input constant current level may be programmed up to 1.0A for rapid charging applications. In the absence of a high current adapter input source, the AAT3689 may be powered from a USB port V_{BUS} supply. The USB constant charge current can be externally programmed for maximum constant current charge levels up to 500mA. The USB charge function is automatically disabled when an adapter input power source greater than 4.5V is present.

Status monitor output pins are provided to indicate the battery charge status by directly driving two external LEDs.

Battery temperature and charge state are fully monitored for fault conditions. In the event of an over-voltage or over-temperature failure, the device will automatically shut down, thus protecting the charging device, control system, and the battery under charge. In addition to internal charge controller thermal protection, the AAT3689 also provides a temperature sense feedback function (TS pin) from the battery to shut down the device in the event the battery exceeds its own thermal limit during charging.

Charging Operation

Regardless of which charge input function is selected (i.e., either the adapter input or USB input), the AAT3689 has four basic modes for the battery charge cycle: pre-conditioning/trickle charge; constant current/fast charge; constant voltage; and end of charge (see Figure 1).

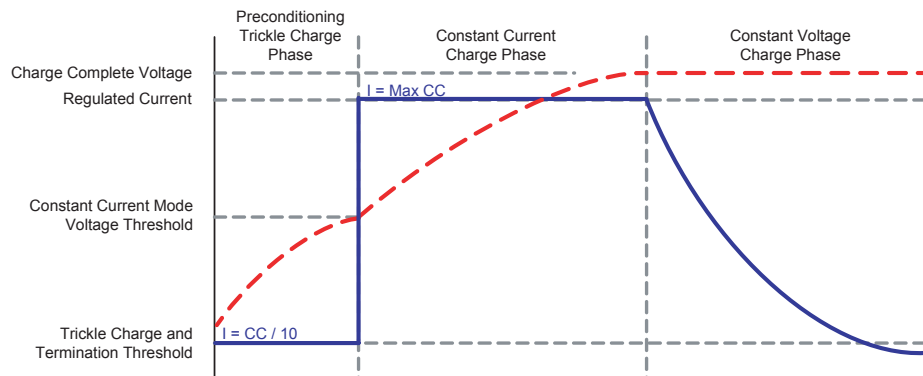

Figure 1: Current vs. Voltage Profile During Charging Phases.

Battery Preconditioning

Before the start of charging, the AAT3689 checks several conditions in order to assure a safe charging environment. The input supply must be above the minimum operating voltage, or under-voltage lock-out threshold (V_{UVLO}), for the charging sequence to begin. Also, the cell temperature, as reported by a thermistor connected to the TS pin from the battery, must be within the proper window for safe charging. When these conditions have been met and a battery is connected to the BAT pin, the AAT3689 checks the state of the battery. If the cell voltage is below the Preconditioning Voltage Threshold (V_{MIN}), the AAT3689 begins preconditioning the cell.

The battery preconditioning trickle charge current is equal to the fast charge constant current divided by 10. For example, if the programmed fast charge current is 500mA, then the preconditioning mode (trickle charge) current will be 50mA. Cell preconditioning is a safety precaution for a deeply discharged battery and also aids in limiting power dissipation in the pass transistor when the voltage across the device is at the greatest potential.

Fast Charge / Constant Current Charging

The cell preconditioning continues until the voltage on the BAT pin exceeds the Preconditioning Voltage Threshold (V_{MIN}). At this point, the AAT3689 begins the constant-current fast charging phase. The fast charge Constant Current (I_{CC}) amplitude is determined by the charge mode, ADP or USB, and is programmed by the user via the R_{SETADP} and R_{SETUSB} resistors. The AAT3689 remains in constant current

charge mode until the battery reaches the voltage regulation point, V_{BAT_EOC} .

Constant Voltage Charging

The system transitions to a constant voltage charging mode when the battery voltage reaches output charge regulation threshold (V_{BAT_EOC}) during the constant current fast charge phase. The regulation voltage level is factory programmed to 4.2V ($\pm 1\%$). The charge current in the constant voltage mode drops as the battery cell under charge reaches its maximum capacity.

End of Charge Cycle Termination and Recharge Sequence

When the charge current drops to 7.5% of the programmed fast charge current level in the constant voltage mode, the device terminates charging and goes into a standby state. The charger will remain in a standby state until the battery voltage decreases to a level below the battery recharge voltage threshold (V_{RCH}).

When the input supply is disconnected or drops below UVLO or $EN = 0$, the charger will automatically enter power-saving sleep mode. Consuming an ultra-low 0.3 μ A in sleep mode, the AAT3689 minimizes battery drain when it is not charging. This feature is particularly useful in applications where the input supply level may fall below the battery charge or under-voltage lockout level. In such cases where the AAT3689 input voltage drops, the device will enter the sleep mode and automatically resume charging once the input supply has recovered from its fault condition.

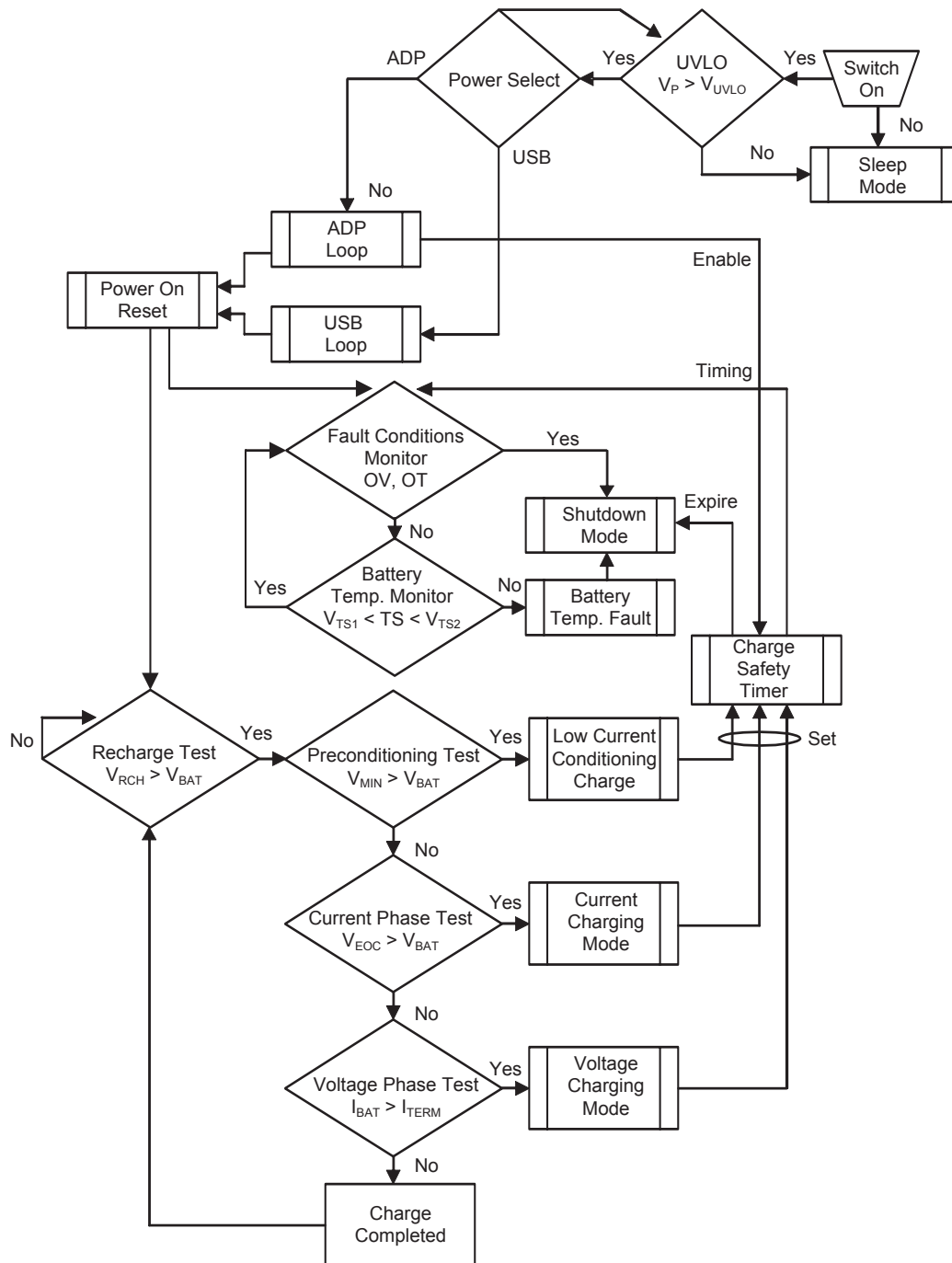
System Operation Flow Chart

Application Information

AC Adapter / USB System Power Charging

Adapter Mode

In the adapter mode, constant current charge levels up to 1.0A may be programmed by the user. The AAT3689 system control will always select the adapter input over the USB supply input whenever adapter voltage is present on the ADP pin. The AAT3689 will operate from the adapter input over a 4.0V to 5.5V range.

The constant current fast charge current for the adapter input mode is set by the R_{SETADP} resistor connected between the ADPSET pin and ground. Refer to Table 1 for recommended R_{SETADP} values for a desired constant current charge level. The precise charging function in the adapter mode may be read from the status LEDs. Please refer to the Battery Charge Status Indication discussion in this datasheet for further details.

Adapter Input Charge Inhibit and Resume

The AAT3689 has an under-voltage lockout and power on reset feature so that if the input supply to the adapter pin drops below the UVLO threshold the charger will suspend charging and shut down. When power is re-applied to the adapter pin or the UVLO condition recovers and $V_{ADP} > V_{BAT}$, the system charge control will assess the state of charge on the battery cell and will automatically resume charging in the appropriate mode for the condition of the battery.

USB Mode

The AAT3689 provides an input for intelligent USB charging. When no voltage is present on the adapter input pin, the charge controller will automatically switch to accepting power from the USB input. The USB charge may be user programmed to any level between 50mA and 500mA by selecting the appropriate resistor values for R_{SETUSB} . Refer to Table 1 for recommended R_{SETUSB} values for the desired USB input constant current charge levels.

I_{CC}	ADP R_{SET} (k Ω)	USB R_{SET} (k Ω)
50	N/A	86.6
75	N/A	57.6
100	84.5	42.2
200	43.2	21.0
300	28.0	13.7
400	21.0	10.2
500	16.9	8.06
600	13.3	N/A
700	11.5	N/A
800	10.2	N/A
900	9.09	N/A
1000	8.06	N/A

Table 1: Resistor Values.

USB Input Charge Inhibit and Resume

The AAT3689 UVLO and power on reset feature will function when the USB input pin voltage level drops below the UVLO threshold. At this point, the charger will suspend charging and shut down. When power is re-applied to the USB pin or the UVLO condition recovers, the system charge control will assess the state of charge on the battery cell and will automatically resume charging in the appropriate mode for the condition of the battery.

Enable / Disable

The AAT3689 provides an enable function to control the charger IC on and off. The enable (EN) pin is active high. When pulled to a logic low level, the AAT3689 will be shut down and forced into the sleep state. Charging will be halted regardless of the battery voltage or charging state. When the device is re-enabled, the charge control circuit will automatically reset and resume charging functions with the appropriate charging mode based on the battery charge state and measured cell voltage.

Programming Charge Current

The fast charge constant current charge level for both Adapter and USB input modes are programmed with set resistors placed between the ADPSET and USBSET pins and ground. The accuracy of the fast charge is dominated by the tolerance of the set resistor used. For this reason, 1%

tolerance metal film resistors are recommended for the set resistor function.

ADP fast charge constant current levels from 100mA to 1.0A may be set by selecting the appropriate resistor value from Table 1.

The USB charge may be set to any level between 50mA and 500mA depending upon the system design requirements for a given USB charge application. Refer to Table 1 and Figure 2 for recommended R_{SETUSB} values.

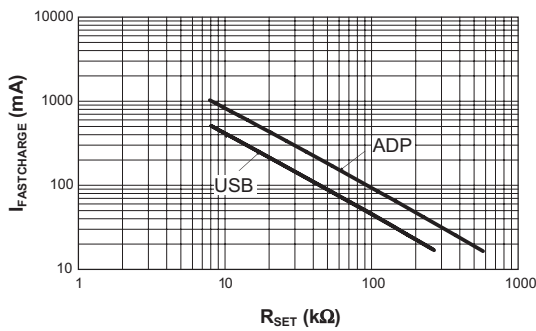

Figure 2: $I_{FASTCHARGE}$ vs. R_{SET} .

Protection Circuitry

Programmable Watchdog Timer

The AAT3689 contains a watchdog timing circuit for the adapter input charging mode. No watchdog timing functions are active for the USB input mode. Typically, a 0.1 μ F ceramic capacitor is connected between the CT pin and ground. When a 0.1 μ F ceramic capacitor is used, the device will time a shutdown condition if the trickle charge mode exceeds 25 minutes or the combined trickle charge plus fast charge mode exceeds three hours. When the device transitions to the constant voltage mode, the timing counter is reset and will time out after three hours and shut down the charger.

Mode	Time
Trickle Charge (TC) Time Out	25 minutes
Trickle Charge (TC) + Fast Charge (CC) Time Out	3 hours
Constant Voltage (VC) Mode Time Out	3 hours

Table 2: Summary for a 0.1 μ F Used for the Timing Capacitor.

The CT pin is driven by a constant current source and will provide a linear response to increases in the timing capacitor value. Thus, if the timing capacitor were to be doubled from the nominal 0.1 μ F value, the time-out times would be doubled.

If the programmable watchdog timer function is not needed, it may be disabled by connecting the CT pin to ground. The CT pin should not be left floating or un-terminated, as this will cause errors in the internal timing control circuit.

The constant current provided to charge the timing capacitor is very small, and this pin is susceptible to noise and changes in capacitance value. Therefore, the timing capacitor should be physically located on the printed circuit board layout as closely as possible to the CT pin. Since the accuracy of the internal timer is dominated by the capacitance value, 10% tolerance or better ceramic capacitors are recommended. Ceramic capacitor materials such as X7R and X5R type are a good choice for this application.

Over-Voltage Protection

An over-voltage event is defined as a condition where the voltage on the BAT pin exceeds the maximum battery charge voltage and is set by the over-voltage protection threshold (V_{OVP}). If an over-voltage condition occurs, the AAT3689 charge control will shut down the device until voltage on the BAT pin drops below the over-voltage protection threshold (V_{OVP}). The AAT3689 will resume normal charging operation after the over-voltage condition is removed. During an over-voltage event, the STAT LEDs will report a system fault.

Over-Temperature Shutdown

The AAT3689 has a thermal protection control circuit which will shut down charging functions should the internal die temperature exceed the preset thermal limit threshold.

Battery Temperature Fault Monitoring

In the event of a battery over-temperature condition, the charge control will turn off the internal pass device. The STAT LEDs will display a system fault. After the system recovers from a temperature fault, the device will resume charging operation.

The AAT3689 checks battery temperature before starting the charge cycle, as well as during all stages of charging. This is accomplished by monitoring the voltage at the TS pin. This system is intended to use negative temperature coefficient (NTC) thermistors, which are typically integrated into the battery package. Most commonly used NTC thermistors used in battery packs are approximately 10kΩ at room temperature (25°C).

The TS pin has been specifically designed to source 80μA of current to the thermistor. The voltage on the TS pin that results from the resistive load should stay within a window from 330mV to 2.30V. If the battery becomes too hot during charging due to an internal fault, the thermistor will heat up and reduce in value, thus pulling the TS pin voltage lower than the T_{S1} threshold and the AAT3689 will signal the fault condition.

If the use of the TS pin function is not required by the system, it should be terminated to ground using a 10kΩ resistor.

Battery Charge Status Indication

The AAT3689 has two status LED driver outputs. These two LEDs can indicate simple functions such as no battery charge activity, battery charging, charge complete, and charge fault.

Status Indicator Display

Simple system charging status may be displayed using one or two LEDs in conjunction with the STAT1 and STAT2 pins on the AAT3689. These two pins are simple switches to connect the LED cathodes to ground. It is not necessary to use both display LEDs if a user simply wants to have a single lamp to show "charging" or "not charging." This can be accomplished by using the STAT1 pin and a single LED. Using two LEDs and both STAT pins simply gives the user more information to the charging states. Refer to Table 3 for LED display definitions.

The LED anodes should be connected to either V_{USB} or V_{ADP} , depending upon the system design

requirements. The LEDs should be biased with as little current as necessary to create reasonable illumination; therefore, a ballast resistor should be placed between the LED cathodes and the STAT1/2 pins. LED current consumption will add to the overall thermal power budget for the device package, so it is wise to keep the LED drive current to a minimum. 2mA should be sufficient to drive most low-cost green or red LEDs. It is not recommended to exceed 8mA for driving an individual status LED. The required ballast resistor value can be estimated using the following formulas:

For connection to the adapter supply:

$$R_{B(STAT1/2)} = \frac{V_{ADP} - V_{F(LED)}}{I_{LED(STAT1/2)}}$$

Example:

$$R_{B(STAT1)} = \frac{5.5V - 2.0V}{2mA} = 1.75k\Omega$$

Note: Red LED forward voltage (V_F) is typically 2.0V @ 2mA.

For connection to the USB supply:

$$R_{B(STAT1/2)} = \frac{V_{USB} - V_{F(LED)}}{I_{LED(STAT1/2)}}$$

Example:

$$R_{B(STAT2)} = \frac{5.0V - 3.2V}{2mA} = 900\Omega$$

Note: Green LED forward voltage (V_F) is typically 3.2V @ 2mA.

The status LED display conditions are described in Table 3.

Event Description	STAT1	STAT2
Charge Disabled or Low Supply	Off	Off
Charge Enabled Without Battery	Flash ¹	Flash ¹
Battery Charging	On	Off
Charge Completed	Off	On
Fault	On	On

Table 3: Status LED Display Conditions.

Capacitor Selection

Input Capacitor

In general, it is good design practice to place a decoupling capacitor between the ADP and USB pins and ground. An input capacitor in the range of 1 μ F to 22 μ F is recommended. If the source supply is unregulated, it may be necessary to increase the capacitance to keep the input voltage above the under-voltage lockout threshold during device enable and when battery charging is initiated.

If the AAT3689 adapter input is to be used in a system with an external power supply source, such as a typical AC-to-DC wall adapter, then a C_{IN} capacitor in the range of 10 μ F should be used. A larger input capacitor in this application will minimize switching or power bounce effects when the power supply is "hot plugged." Likewise, a 10 μ F or greater input capacitor is recommended for the USB input to help buffer the effects of USB source power switching, noise, and input cable impedance.

Output Capacitor

The AAT3689 only requires a 1 μ F ceramic capacitor on the BAT pin to maintain circuit stability. This value should be increased to 10 μ F or more if the battery connection is made any distance from the charger output. If the AAT3689 is to be used in applications where the battery can be removed from the charger, such as in the case of desktop charging cradles, an output capacitor greater than 10 μ F may be required to prevent the device from cycling on and off when no battery is present.

Printed Circuit Board Layout Considerations

For the best results, it is recommended to physically place the battery pack as close to the AAT3689 BAT pin as possible. To minimize voltage drops on the PCB, keep the high current carrying traces adequately wide. For maximum power dissipation of the AAT3689 TDFN package, the metal substrate should be solder bonded to the board. It is also recommended to maximize the substrate contact to the PCB ground plane layer to further increase local heat dissipation.

1. Flashing rate depends on output capacitance.

AAT3689 Evaluation Board Layout

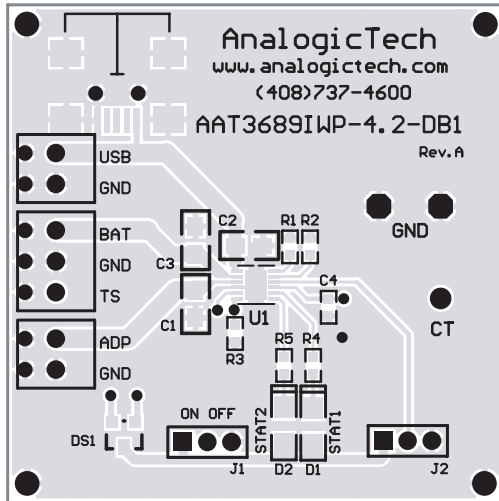

Figure 5: AAT3689 Evaluation Board Component Side Layout.

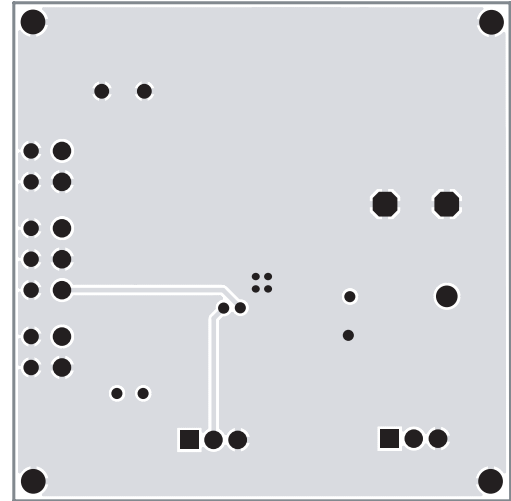
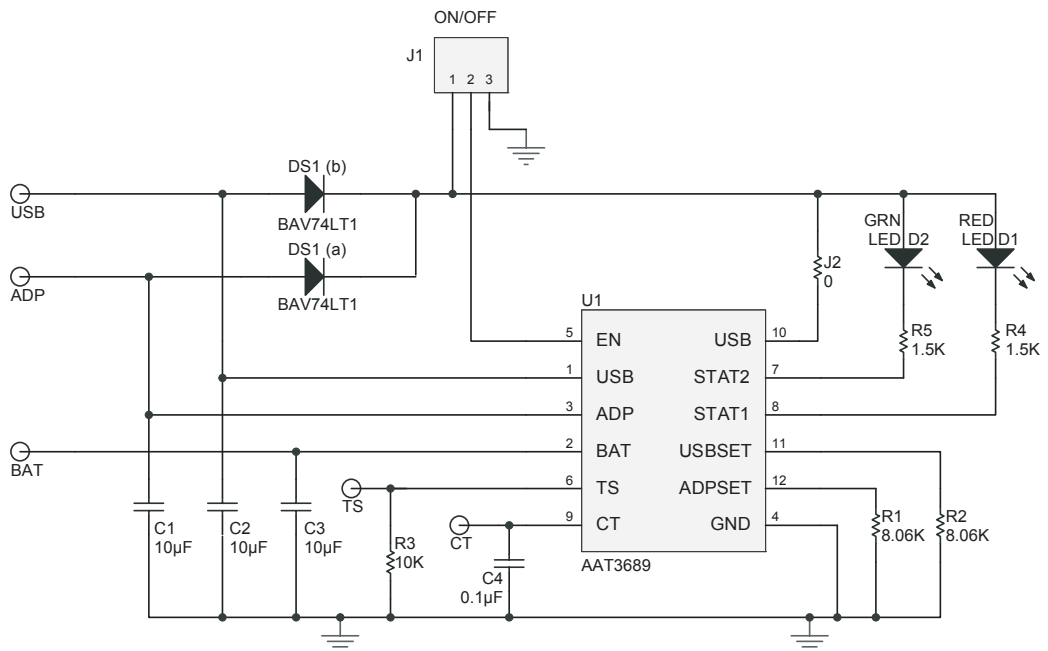

Figure 6: AAT3689 Evaluation Board Solder Side Layout.

AAT3689 Evaluation Board Schematic Diagram



AAT3689 Evaluation Board Bill of Materials

Component	Part Number	Description	Manufacturer
U1	AAT3689IFP-4.2-T1	0.5A/1.0A USB Port/Adapter Lithium-Ion/Polymer Battery Charger; 12-Pin 3x3 TDFN Package	AnalogicTech
R1, R2	Chip Resistor	8.06K Ω , 1%, 1/4W; 0603	Vishay
R3	Chip Resistor	10K Ω , 5%, 1/4W; 0603	Vishay
R4, R5	Chip Resistor	1.5K Ω , 5%, 1/4W; 0603	Vishay
C1, C2, C3	GRM21BR61A106KE19	CER 10 μ F 10V 10% X5R 0805	Murata
C4	GRM188R71C104KA01	CER 0.1 μ F 16V 10% X7R 0603	Murata
JP1	PRPN401PAEN	Conn. 3-pin Header, 2mm zip	Sullins Electronics
JP2	Chip Resistor	0 Ω	Vishay
D1	CMD15-21SRC/TR8	Red LED; 1206	Chicago Miniature Lamp
D2	CMD15-21VGC/TR8	Green LED; 1206	Chicago Miniature Lamp
DS1 (a, b)	BAV74LT-A	Default Diode; SOT23-3	On Semi

Ordering Information

Package	Marking ¹	Part Number (Tape and Reel) ²
TDFN33-12	RQXY	AAT3689IWP-4.2-T1



All AnalogicTech products are offered in Pb-free packaging. The term “Pb-free” means semiconductor products that are in compliance with current RoHS standards, including the requirement that lead not exceed 0.1% by weight in homogeneous materials. For more information, please visit our website at <http://www.analogictech.com/pbfree>.

Package Information³

TDFN33-12

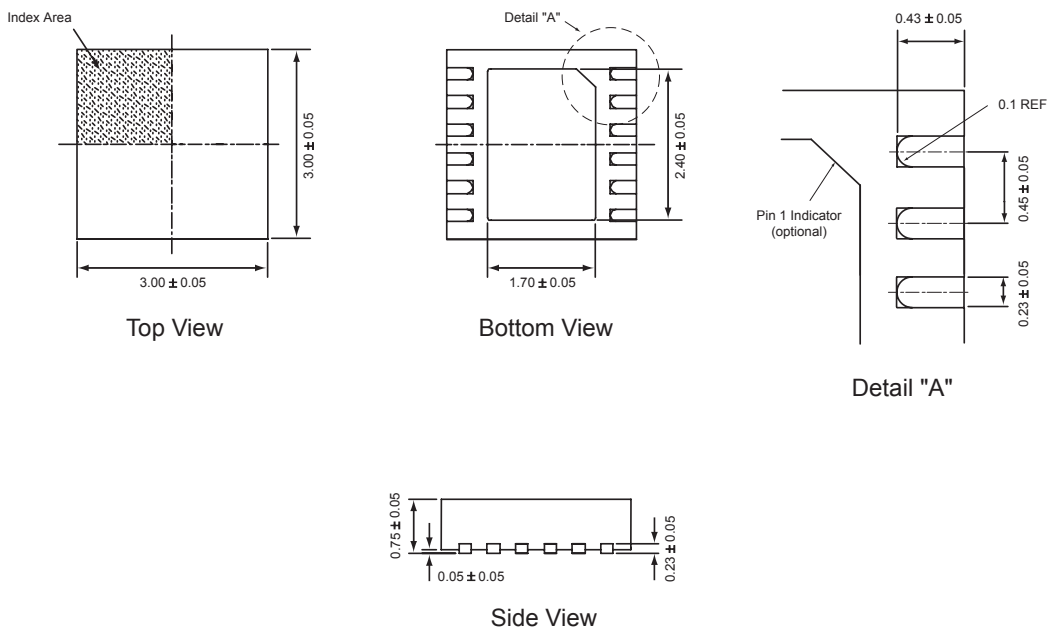

All dimensions in millimeters.

1. XYY = assembly and date code.
2. Sample stock is generally held on part numbers listed in **BOLD**.
3. The leadless package family, which includes QFN, TQFN, DFN, TDFN and STDFN, has exposed copper (unplated) at the end of the lead terminals due to the manufacturing process. A solder fillet at the exposed copper edge cannot be guaranteed and is not required to ensure a proper bottom solder connection.



AAT3689
0.5A/1.0A USB Port/Adapter
Lithium-Ion/Polymer Battery Charger

© Advanced Analogic Technologies, Inc.

AnalogicTech cannot assume responsibility for use of any circuitry other than circuitry entirely embodied in an AnalogicTech product. No circuit patent licenses, copyrights, mask work rights, or other intellectual property rights are implied. AnalogicTech reserves the right to make changes to their products or specifications or to discontinue any product or service without notice. Customers are advised to obtain the latest version of relevant information to verify, before placing orders, that information being relied on is current and complete. All products are sold subject to the terms and conditions of sale supplied at the time of order acknowledgement, including those pertaining to warranty, patent infringement, and limitation of liability. AnalogicTech warrants performance of its semiconductor products to the specifications applicable at the time of sale in accordance with AnalogicTech's standard warranty. Testing and other quality control techniques are utilized to the extent AnalogicTech deems necessary to support this warranty. Specific testing of all parameters of each device is not necessarily performed.

AnalogicTech and the AnalogicTech logo are trademarks of Advanced Analogic Technologies Incorporated. All other brand and product names appearing in this document are registered trademarks or trademarks of their respective holders.

Advanced Analogic Technologies, Inc.
830 E. Arques Avenue, Sunnyvale, CA 94085
Phone (408) 737-4600
Fax (408) 737-4611

