



# PRODUCT SPECIFICATION

**Model No : CST-432M9/431M9**

## Descriptions:

- 0.4 Inch Triad Digits Display
- CST-432: Common Anode
- CST-431: Common Cathode
- Emitting Color: Super Bright Yellow Green



CUSTOMER APPROVED SIGNATURES	APPROVED BY	CHECKED BY	PREPARED BY

**CHINA SEMICONDUCTOR CORPORATION**

Address:2FL. NO.909,Chung-Cheng Road,  
Chung-Ho City Taipei Hsien,Taiwan.

Tel:886-2-2223-9696  
Fax:886-2-2223-9377

**OPTO PLUS TECHNOLOGIES CO.,LTD**

Address:696 Shun jiang Rd.,Ji Shan St.Shaoxing,  
ZheJiang,China

Tel:86-0575-88623888  
Fax:86-0575-88623112



**Model No : CST-432/431M9**

**Features -**

1. 0.4 inch (10.2mm) digit height.
2. Case mold type.
3. RoHS compliant.
4. Low power consumption.
5. Easy mounting on P.C. board or socket.

**Device Selection Guide -**

Part No.	Chip		Description
	Material	Emitted Color	
CST-432M9	AlGaInP	Super Bright Yellow	Common Anode
CST-431M9		Super Bright Green	Common Cathode

**Package Dimensions -**

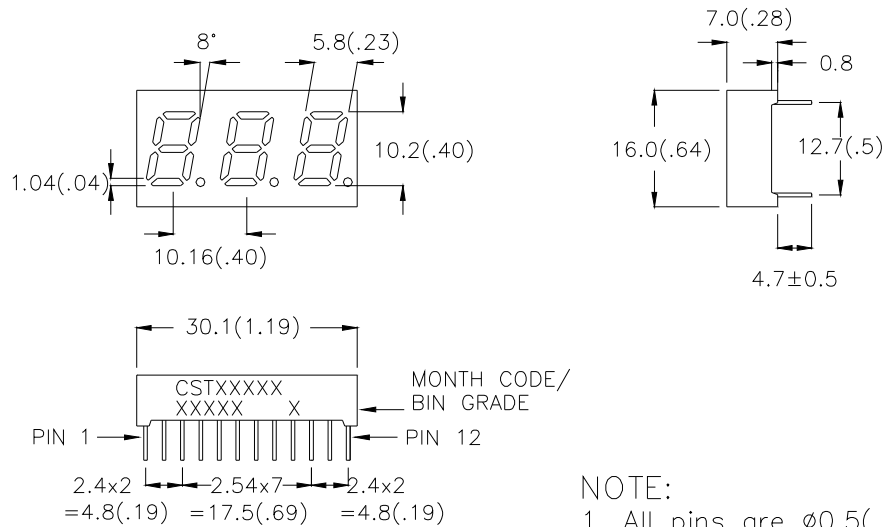

**NOTE:**

1. All pins are  $\phi 0.5(.02)$ .
2. Dimension in millimeter (inch), and tolerance is  $\pm 0.25 (.01)$  unless otherwise noted.



Model No : CST-432/431M9

Internal Circuit Diagrams -

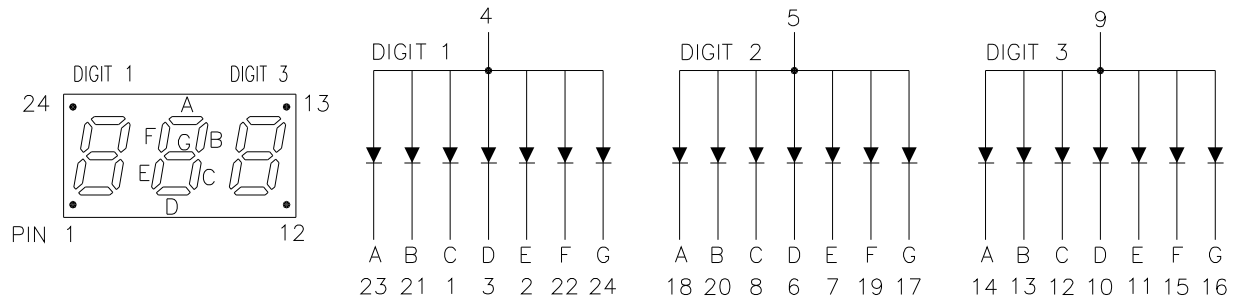

CST-432 Common Anode  
(CST-431 Common Cathode)

Absolute Maximum Rating -

(Ta=25°C)

Parameter	Symbol	Rating	Unit
Power Dissipation Per Dice	<b>P<sub>AD</sub></b>	70	mW
Continuous Forward Current Per Dice	<b>I<sub>AF</sub></b>	25	mA
Peak Current Per Dice(duty cycle 1/10,1KHz)	<b>I<sub>PF</sub></b>	90	mA
Derating Linear From 25°C Per Dice	-	0.33	mA/°C
Reverse Voltage Per Dice	<b>V<sub>R</sub></b>	5	V
Operating Temp.	<b>T<sub>opr</sub></b>	-35 ~ +85	°C
Storage Temp.	<b>T<sub>stg</sub></b>	-35 ~ +85	°C
Solder temperature 1/16 inch below seating plane for 3 seconds at 260°C			



Model No : CST-432/431M9

■ Electro-optical Characteristics -

(Ta=25°C)

Parameter	Symbol	Min.	Typ.	Max.	Unit	Condition
Forward Voltage Per Segment	V <sub>F</sub>	-	2.1	2.8	V	I <sub>F</sub> =20mA
Luminous Intensity Per Segment	I <sub>v</sub>	-	9	-	mcd	I <sub>F</sub> =10mA
Peak Emission Wavelength	λ <sub>p</sub>	-	572	-	nm	I <sub>F</sub> =20mA
Dominant Wavelength	λ <sub>d</sub>	-	570	-	nm	I <sub>F</sub> =20mA
Spectrum Radiation Bandwidth	Δλ	-	20	-	nm	I <sub>F</sub> =20mA
Reverse Current	I <sub>R</sub>	-	-	100	μA	V <sub>R</sub> =5V
Luminous Intensity Matching Ratio	IV-m	-	-	2:1	-	I <sub>F</sub> =10mA



**Model No : CST-432/431M9**

**Typical Electrical / Optical Characteristics Curves -**

**(Ta = 25°C Unless Otherwise Noted)**

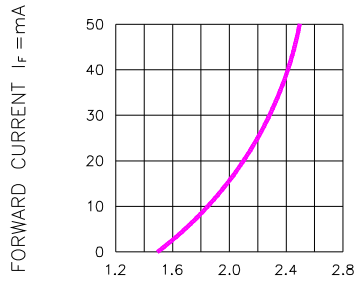

FORWARD VOLTAGE (V<sub>F</sub>) -VOLTS  
Fig.1 FORWARD CURRENT VS. FORWARD VOLTAGE

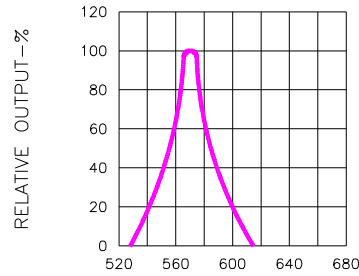

WAVELENGTH (λ) -nm  
Fig.2 SPECTRAL RESPONSE

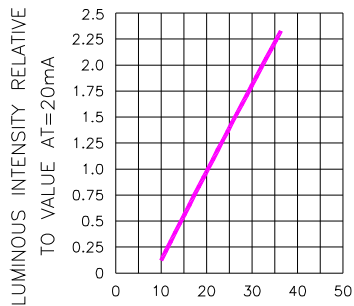

I<sub>F</sub> -FORWARD CURRENT -mA  
Fig.3 RELATIVE LUMINOUS INTENSITY VS. FORWARD CURRENT

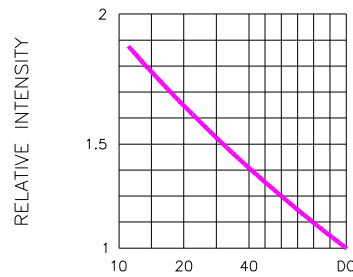

DUTY CYCLE % PER SEGMENT (AVERAGE I<sub>F</sub> =10mA)  
Fig.5 LUMINOUS INTENSITY VS. DUTY CYCLE

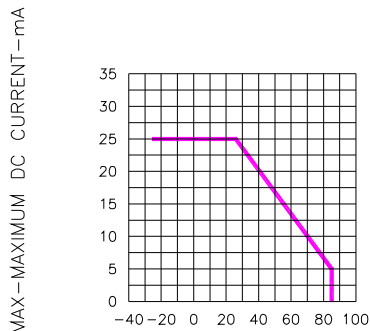

T<sub>A</sub> AMBIENT TEMPERATURE °C  
Fig.4 MAXIMUM ALLOWABLE DC CURRENT PER SEGMENT VS. A FUNCTION OF AMBIENT TEMPERATURE

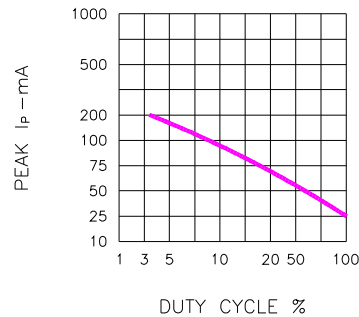

DUTY CYCLE %  
Fig.6 MAX PEAK CURRENT VS. DUTY CYCLE % (REFRESH RATE f=1 KHz)



**Model No : CST-432/431M9**

■ Package Dimensions

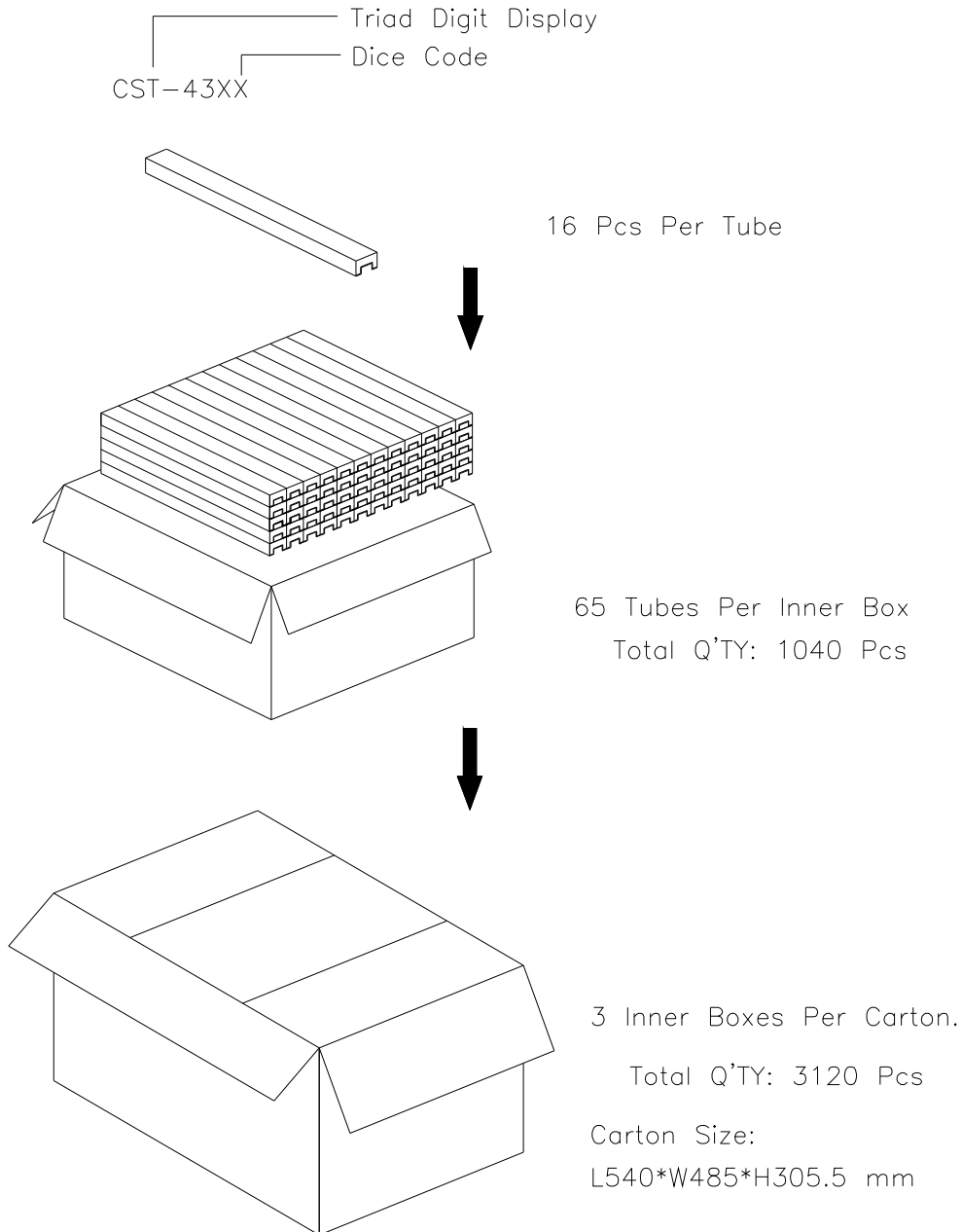

Note: The specifications are subject to change without notice. Please contact us for updated information.